



symmetry surgical™

©2013 Symmetry Surgical, Inc. All rights reserved.

This catalog, or any part thereof, may not be reproduced in any form. Not all products are available in all countries. Symmetry Surgical reserves the right to add, modify or discontinue products as necessary, with or without notice. Symmetry Surgical respects the intellectual property rights of all of its suppliers, vendors, competitors and other third parties. If you have any intellectual property rights concerns with anything appearing in this catalog, please let us know by contacting us at 1.800.251.3000. The S logo and SYMMETRY SURGICAL are registered trademarks of Symmetry Surgical, Inc.

SSCATALOG2013B



A Letter to Our Customers

Welcome to Symmetry Surgical! Thank you for allowing us to be your trusted partner for surgical instrumentation. When we combined the portfolios of Specialty Surgical Instrumentation (SSi), Olsen® Medical and the surgical instruments division of Codman & Shurtleff, Inc., we aspired to elevate what you expect from a medical device company—creating the industry standard for quality, customer service and total value.

Whether you've worked with our legacy businesses for many years, or we've recently begun our relationship, we want you to know that our Promise to our Customers drives every decision we make:

- We are passionate about our mission to improve patient outcomes.
- We are dedicated to delivering exceptional quality and service.
- We are collaborative with our customers, responding directly to clinician and provider needs with new innovations that help deliver superior patient care.

To help deliver on our Promise to our Customers, we're very excited to provide you with the Symmetry Surgical Instrument Desk Reference, the latest release of our medical device catalog. This catalog represents the industry's most comprehensive portfolio of surgical instruments and products that have been developed from your suggestions and insight, as well as our knowledge and expertise in this marketplace.

We're truly grateful to our expanding customer base of thousands of hospitals, surgical centers and medical offices around the world. We continue to make considerable investments in our business, with the goal of making our company easy—and a delight—to do business with. As we grow our business, we're investing in our people, products and processes—creating an environment of quality and accountability that enables us to maintain the highest standards and levels of compliance possible.

We work hard every day to fulfill our Promise to our Customers. We take great pride in making sure that every experience with our company is a positive one, whether on the phone, via fax or email, or online. Superior customer service will be a keystone of our brand and an attribute that differentiates us from the rest in the industry.

If we can ever be of assistance to you, feel free to call us directly. We sincerely appreciate your business and thank you for your continued support.

Sincerely,

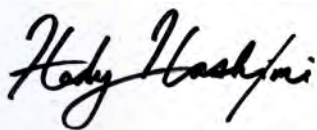

Hedy Hashemi
Vice President, Global Marketing



Keith Sweeney
Vice President, US Sales

Please note: Codman & Shurtleff, Inc. continues to be one of the largest neurosurgery, neurovascular and neuromodulation companies in the world. Symmetry's acquisition pertained only to Codman's reusable stainless steel and titanium surgical instrument and retractor systems, sterile disposable surgical products (vein strippers, SECTO® dissectors, tonsil sponges and surgical marker pens), and sterilization containers.

The Surgical Instrument Desk Reference

How to Use Our Catalog

The Symmetry Surgical catalog is designed with you in mind, to be your trusted resource for surgical instrumentation. We took great care in creating an easy-to-use, robust catalog and we think you'll be pleased with the design as you become more familiar with our broad portfolio.

Layout

The catalog is organized by surgical specialty *and* product function.

To find a section, look along the right-hand thumb tabs. The tabs are organized alphabetically to help you easily find what you need. You'll notice we have included special sections highlighting surgical instruments that are designed specifically for obese patients and pediatrics. We hope these options give you even more flexibility to find the instruments you need quickly and easily.

And we know that it is difficult to pick up an instrument and know what specialty it's listed in. To make your job easier, we've sorted the instruments in our portfolio by surgical function, too, including Energy, Laparoscopic, Retractors and Sterilization Solutions.

Finally, we know a well-designed index is the most important tool to helping you find what you need. Our catalog features an index that includes products listed by proper name, function and product code.

Resources

Throughout the catalog, we have included many tools to make it more valuable to support the way you work best. We're including actual product photos in our catalog, most often in color! When a single photo represents a product family, we identified the product code in the photo. And, we've included tabbed sticky notes to mark your favorite products, rulers, French size charts, suture charts, a magnifying bookmark and other fun and handy reference materials. We hope you find them delightful as you explore the new catalog.

On the front page of each section, you'll find a QR code, which, when scanned with your smart device's QR code reader, will take you to the Symmetry Surgical website where you can locate additional resources.

And, as always you have the benefit of a global team of surgical instrument experts available to answer your questions. Whether it's related to our catalog, our products or an industry topic, we're available to help you at every turn.

U.S. Customer Service

Your Symmetry Surgical Customer Service team wants to make ordering surgical instruments the easiest part of your day. We accept orders via phone, fax, email, our website, Global Healthcare Exchange (GHX) and through the mail.

PHONE

1.800.251.3000

(Available Monday through Friday, 8:30 AM–6:30 PM EST)

FAX

1.800.342.3272

EMAIL

customerservice@symmetrysurgical.com

ONLINE

symmetrysurgical.com

MAILING ADDRESS

Symmetry Surgical
Attn: Customer Service
3034 Owen Drive
Antioch, TN 37013

The Surgical Instrument Desk Reference

International Customer Service

PHONE

Symmetry Surgical Switzerland GmbH
+41 (0) 52 557 59 00
(Available Monday through Friday, 7:00-16:00 GMT)

Symmetry Surgical, Inc., USA
1.615.964.5672
(Available Monday through Friday, 8:30 AM–6:30 PM EST)

FAX

Symmetry Surgical Switzerland GmbH
+41 (0) 52 557 59 99

EMAIL

customerservice@symmetrysurgical.com
internationalorders@symmetrysurgical.com

ONLINE

symmetrysurgical.com

MAILING ADDRESS

Symmetry Surgical Switzerland GmbH
Bühlstrasse 27
CH-8200 Schaffhausen
Switzerland

Symmetry Surgical, Inc.
3034 Owen Drive
Antioch, TN 37013

INTERNATIONAL PAYMENT TERMS/RETURN GOODS POLICY/INSTRUMENT REPAIR & RESTORE PROGRAM/LITERATURE REQUESTS

Please contact your local distributor. Locate a local distributor contact, International Customer Service at +41 (0) 52 557 59 00 or 1.615.964.5672 (US).

Cardiovascular/Thoracic

Energy

Ear, Nose & Throat

General

Laparoscopic

Neurology

Obesity

OB/GYN

Ophthalmology

Orthopedics & Arthroscopy

Pediatrics

Rectal

Retractors

Spine

Urology

Sterilization Solutions

Alphabetical & Numeric Indexes



Terms & Conditions of Sale

General

These general terms and conditions of sale, effective September 4, 2012, (“Terms and Conditions”) exclusively govern the sale of all Symmetry Surgical Inc. (“Symmetry Surgical”) products in the United States, including but not limited to:

ACCESS SURGICAL® Endoscopic Surgical Instruments
BOOKWALTER® Retractor Systems
BOOKWALTER ROTILT® Retractor Systems
CLASSIC PLUS® and **CLASSIC®** Surgical Instruments
FLASHPAK® Closed Flash Sterilization Trays
MAGNAFREE® Non-Magnetic Surgical Instruments
MICROCARE® Surgical Instrument Sterilization Trays
MICROSECT® Surgical Instruments
MICROVASC® Surgical Instruments
OLSEN® Electrosurgical Instruments
OPTI-LENGTH® Extended Length Surgical Instruments
PRESERVE® Instrument Lubricant
QUAD-LOCK® Sterilization Container Systems
RAPIDCLEAN® Detachable Kerrison Rongeurs
RILEY™ Sterilization Case and Tray Solutions
SECTO® Surgical Dissectors
ULTRA™ Surgical Instruments
ULTRA™ System Sterilization Container Systems

The following trademarks are used with permission:

GREENBERG® Neurosurgical Retractor System is a trademark of I.M. Greenberg, M.D.

KARLIN™ Surgical Instruments is a trademark of Karlin Technology, Inc.

CROCKARD™ is a trademark of Hillway Surgical, Ltd.

HARDY™ is a trademark of Jules Hardy, M.D.

MALIS® is a trademark of Synergetics USA, Inc.

RHOTON® is a trademark of Al Rhoton, M.D.

Symmetry Surgical reserves the right to modify these Terms and Conditions at any time without prior written notice. No additions to or modifications of these Terms and Conditions will be binding on Symmetry Surgical unless agreed to in writing and signed by an authorized representative of Symmetry Surgical and these Terms and Conditions represent the entire agreement between the parties and completely supersede any prior agreements or understandings, whether oral or written.

Symmetry Surgical specifically objects to and does not accept any other Terms and Conditions that may be proposed by the buyer, included on any Purchase Order or other communication. Acceptance by Symmetry Surgical of buyer’s purchase order(s) is expressly conditioned on buyer’s assent to all of the Terms and Conditions contained herein.

Ordering Information

Symmetry Surgical is proud to provide quality products, combined with exceptional customer service, for the complete product line. Our global customer service team is available 8:30 AM to 6:30 PM (EST) and 7:00 to 16:00 (GMT), Monday through Friday, excluding holidays. All orders that are not paid via credit card require a purchase order number and contact name. Credit card orders are accepted via phone 1.800.251.3000 (US) and +41 (0) 52 557 59 00, GHX, EDI and the web. All orders are subject to acceptance by Symmetry Surgical.

To ensure accuracy in ordering, please include the following information when placing your order:

1. Your Customer Number*
2. PO Number
3. Buyer Name with Contact Number and Email Address
4. Catalog Number
5. Quantity
6. Unit of Measure
7. Product Description
8. Complete Billing and Shipping Addresses
9. Special Instructions (e.g.: etching, color coating, method of shipment)
10. Pricing

*Your customer number can be provided for you by the Symmetry Surgical Customer Service Department. All orders are subject to acceptance by Symmetry Surgical.

Terms & Conditions of Sale

GLOBAL HEALTHCARE EXCHANGE (GHX)

Symmetry Surgical offers secure online ordering through the Global Healthcare Exchange. GHX provides a connection point for healthcare buyer organizations to electronically trade with their vendors through the GHX exchange. Existing GHX Connect Plus Customers can set up ordering from Symmetry Surgical by completing a supplier on-boarding form through GHX.

ORDER BY PHONE

Our Customer Service representatives are available by phone Monday through Friday between the hours of 8:30 AM and 6:30 PM (EST) at **1.800.251.3000** and 7:00 and 16:00 (GMT) at **+41 (0) 52 557 59 00**.

ORDER BY FAX

You may fax your order 24 hours a day via our toll free fax number **1.800.342.3272** (US) or **+41 (0) 52 557 59 99**. A full confirmation of your order, including reference number and pricing information, will be faxed to you within 24 hours Monday through Friday.

ORDER ONLINE

Our website www.symmetrysurgical.com enables licensed medical facilities to electronically order products via a secure internet connection. To sign-up for online ordering, please follow the instructions in the enrollment document on the website.

ORDER BY EMAIL

You may email your order 24 hours a day to **orders@symmetrysurgical.com** (US) or **internationalorders@symmetrysurgical.com**. A full confirmation of your order, including reference number and pricing information, will be emailed back to you within 24 hours, Monday through Friday.

ORDER BY MAIL

Purchase orders may be addressed to:
Symmetry Surgical, Inc.
3034 Owen Drive
Antioch, TN 37013
Attn: Customer Service

Symmetry Surgical Switzerland GmbH
Bühlstrasse 27
CH-8200 Schaffhausen
Switzerland

AUTHORIZED DISTRIBUTORS

Call Customer Service to find a Symmetry Surgical Authorized Distributor local to your facility at **+41 (0) 52 557 59 00**.

New Customer Setup

Symmetry Surgical only sells to licensed physicians, authorized distributors and facilities. A new customer must complete a customer maintenance form and credit application to establish an account with Symmetry Surgical before orders may be shipped. To establish an account, please contact your local Sales Representative or go to our website to register as a new customer.

Prices

Prices are as listed in the Symmetry Surgical current price list, and are subject to change without notice. Prices do not include taxes or shipping costs. Receipt of the Price List or these Terms and Conditions does not authorize buyer to purchase all products listed. Buyer's current purchasing authorization will remain in effect.

GPO and Contracted pricing agreement eligibility will be maintained for all member customer accounts. Customers with significant purchasing volumes that are not members of a contract may be interested in reviewing the features of our Annual Purchase Agreement. For further details, contact your Symmetry Surgical sales representative. Written price quotations are available from the Symmetry Surgical Customer Service Department or your local sales representative.

The prices displayed on our website are quoted in U.S. Dollars. We attempt to be as accurate as possible. However, we cannot warrant that product descriptions or other content on the website is complete, reliable, current, or error-free.

If a product offered by us is not as described, your sole remedy is to return it in unused condition for a refund of the purchase price.

Prices in the Price List are for One Unit, unless otherwise noted. Where prices are for more than One Unit, the minimum shipping units must be ordered.

Terms & Conditions of Sale

REPORTING PRICING DISCREPANCIES

Report all pricing and/or billing charge discrepancies within 30 days of the physical delivery date via email, phone, and/or debit memo. Failure to provide notification within 30 days of the physical receipt of an order will be grounds for denial of the claim.

REPORTING OF DISCOUNTS

The value of any rebates, discounts, incentives, or product provided at no charge to customer may constitute a "discount or other reduction in price" under Section 1128B(b)(3)(A) of the Social Security Act [42 U.S.C. Sec. 1320a-7b(b)(3)(A)]. Buyer must satisfy any and all requirements imposed on buyers relating to discounts or reductions in price, including, when required by law, to disclose all discounts or other reductions in price received from Symmetry Surgical and to accurately report under any state or federal health care program the net cost actually paid by the buyer.

Payment Terms

Payment terms are net 30 days.
All payments must be in U.S. Dollars.

Shipment Terms

All shipments will be assessed shipping charges, which will be prepaid and included in the invoice at the then-current published rates. Our default carrier and shipping mode is FedEx Ground. Shipping terms are F.O.B. Shipping Point and title passes to buyer when a product is provided to the carrier. Customers can elect to use their own carrier account number (UPS or FedEx) and can designate a default mode of transportation. Expedited shipping costs will be passed through at the current published rates for the expedited service level desired (Next Day, 2nd Day, Early AM, Saturday Delivery).

SERVICE LEVEL CUT OFF

Domestic Ground	3:30 PM (EST)
Domestic Rush	5:30 PM (EST)
International	Weekly Consolidated Orders

The standard order cut-off time for same day shipments is 3:30 PM EST. All orders will be shipped ground unless requested otherwise at the time of your order. We are committed to same day shipping for expedited and rush orders of stocked products for orders received by 5:30 PM (EST).

REPORTING SHIPMENT DISCREPANCIES

You must report all shipment discrepancies (shipping, shortages, overages, missing documents, damages, etc.) to Symmetry Surgical Customer Service within 15 calendar days of physical delivery date via email, phone and/or debit memo notification. Failure to provide timely notification within 15 days of physical receipt will be grounds for denial of the claim, and unsubstantiated invoice deductions will not be allowed.

When reporting claims, have the following information available:

- Purchase information (purchase order and invoice number);
- Type of discrepancy and requested Symmetry Surgical action;
- Product information (Symmetry Surgical catalog number, lot or batch number);
- Quantity of products per the packing list;
- Unit of measure terms;
- Contact information (contact name, email, telephone and fax number);
- Copy of carrier's bill of lading or delivery receipt signed by receiving personnel which includes number of packages received and any visible damage noted;
- All proof of delivery requests must be made to the collection department within 90 days of invoice date. Any requests made after 90 days will be denied and the invoice will be due and payable in full.

If you select to ship with your own carrier account number, any claims for damages in transit will need to be filed by you as the shipper with your carrier.

Terms & Conditions of Sale

Return Goods Policy

Symmetry Surgical will accept product returns only to the extent that such products were purchased directly from Symmetry Surgical and returned within 90 days from invoice date.

All product returns must have a Return Goods Authorization (“RGA”) attached with return paperwork. Returns will not be accepted for full credit without an RGA issued by Symmetry Surgical. Returns are to be shipped to the address indicated on the RGA.

To obtain an RGA, email, fax or phone your request to Customer Service via the modes of contact listed on page VIII. In your request you must include the following information:

- Purchase information (purchase order and invoice number);
- Reason for return, including a description of any damage, if applicable;
- Product Information (material number, lot number, UOM, pallet condition, expiration date and quantity);
- Contact Information (contact name, phone and fax number);
- The price(s) you paid for the products you are seeking to return. In the absence of this information, Symmetry Surgical will price returns at the published Best Distributor Price.

An RGA will not be issued, nor will credit be given for the following:

1. Product returned WITHOUT an RGA;
2. Product not purchased from Symmetry Surgical or an Authorized Distributor;
3. Products that are temperature controlled;
4. Products returned in a condition that prevents resale.

Examples include, but are not limited to:

- Discontinued products (Products no longer carried in the current Symmetry Surgical Price List);

- Non-stockable products (Products which have been used);
- Make to Order instruments (Products not included as stocked inventory);
- Custom made instruments;
- Products held beyond 90 days from invoice date;
- Partial kits;
- Engraved, Etched or Color-coded instruments;
- Expired product or product outside minimum dating requirements;
- Units of measure less than Symmetry Surgical’s original unit of issue;
- Product not in original packaging;
- Product that has been cleaned, lubricated, washed, or sterilized.

Product returns MUST be completed within 15 days of the issuance of the RGA to be eligible for full credit. If returned product is shipped after the 15 day expiration of the RGA and the product is received in saleable condition and within shelf life guidelines, Symmetry Surgical reserves the right to refuse the return or charge additional restocking fees.

All non-returnable products will be returned directly to the customer, F.O.B. Destination with a letter of explanation. Returns will be assessed a 15% restocking fee for all product returned between 30–90 days from Original Shipment Date. Returns over 90 days are not eligible for credit.

Make-To-Order Policy

Some products are designated as Make-To-Order because these products have low demand or custom specifications.

Make-To-Order products are delivered according to the noted lead time and transportation time (based on transportation mode). If a transportation mode is not specified on the order, then ground transportation will be utilized.

Terms & Conditions of Sale

Order cancellations, requested delivery date changes or quantity reductions of Make-To-Order products will only be honored within one (1) business day of order placement, after which time no cancellations, requested delivery date changes or quantity reductions will be honored.

Make-to-order products do not qualify for return privileges.

Instrument Repair & Restore Programs

REPAIR PROGRAM

Symmetry Surgical provides a quality repair service for instruments from all manufacturers. Every effort is made by our skilled craftspeople to see that damaged instruments are repaired to optimal working condition. Repaired instruments deemed unacceptable such as those modified by a third party may be returned. Your satisfaction is guaranteed. For Repairs contact repairs@symmetrysurgical.com.

REPAIR & RESTORE WARRANTY

Repair and Restore products are warranted to be free from defects in workmanship and material with respect to the Repair and Restoration work only, and not with respect to the original instrument for 90 Days.

Symmetry Surgical's Repair and Restore Service provides hospitals with an opportunity to refurbish all types of surgical instruments. When performed on a routine basis, the Repair and Restore Service provides the necessary preventive maintenance required by most surgical instruments.

Special Orders

Symmetry Surgical Customer Service Department provides hospitals and surgeons with surgical instrumentation customized to individual specifications. Order forms for "Specials" can be obtained from your sales representative or by contacting the Customer Service Department at 1.800.251.3000 (US) or +41 (0) 52 557 59 00.

Specially manufactured or non-catalog products may be subject to separate terms and conditions of sale. For pricing, delivery, and more information regarding special order products, please call the Customer Service Department at 1.800.251.3000 (US) or +41 (0) 52 557 59 00.

In-Service Instrument Care

Symmetry Surgical provides an In-Service Program on "The Care and Handling of Surgical Instruments" for our surgical instrument customers. This service is conducted by your local Symmetry Surgical Sales Representative.

Export Law Compliance

U.S. law regulates the export, re-export or other transfer of the products that are sold by Symmetry Surgical and purchased under the terms set forth herein. Any required U.S. and non-U.S. government authorization must be obtained prior to shipment, and diversion contrary to U.S. and non-U.S. law is prohibited.

By ordering products from Symmetry Surgical, the buyer agrees to comply fully with all applicable export control laws and regulations of the United States and applicable foreign governments, and expressly assumes responsibility for determining whether a subsequent transaction requires U.S. and non-U.S. government authorization and, if so, for obtaining such authorization before shipping or otherwise transferring the products to another party. Buyer shall not knowingly use, resell or distribute any Symmetry Surgical product directly or indirectly for the development, production or proliferation of weapons of mass destruction (nuclear, chemical, or biological) or missile delivery systems, and/or for terrorist activities.

Business Conduct

In connection with its efforts relating to Symmetry Surgical, Buyer must comply with all applicable laws and regulations. Any conduct inconsistent with laws and regulations which would subject Symmetry

Terms & Conditions of Sale

Surgical to the imposition of any penalties may result in termination of any business relationship between Buyer and Symmetry Surgical, including but not limited to the termination of any contract between them and/or the refusal of Symmetry Surgical to provide products of service to Buyer.

Governing Law & Dispute Resolution

This Agreement shall be governed by and construed in all respects in accordance with the laws of the state of Tennessee in the United States of America.

All claims or differences or other disputes, which arise out of or in connection with this appointment, which cannot be amicably settled by mutual discussion and consent shall be settled, litigated or resolved by the state or federal courts in Nashville Tennessee (or those serving Nashville, Tennessee), or courts of Schaffhausen, Switzerland for international orders, and the parties hereby submit to the exclusive jurisdiction of such courts over any dispute. Each party will bear its own costs in such proceedings.

Distributor Terms & Conditions

Please contact your Symmetry Surgical Representative for details about Distributor Terms & Conditions.

Warranty

The products shown in this catalog are warranted to be free from defects in workmanship or materials. Specific warranty periods and other warranty terms vary and specific warranty information may be included in package inserts with specific products or in operator's manuals for specific products.

Many of the instruments shown in this catalog are manufactured and hand finished by skilled craftsmen. Consequently there may be slight variations in the dimensions of an instrument from those given in the listed specifications. Symmetry Surgical reserves the

right to change or modify the design or dimensions of our products at any time and without notice. Photographs in this catalog are not to scale and may not precisely represent the product.

CLASSIC® branded surgical instruments are warranted for workmanship and materials for five (5) years.

All tungsten carbide inserts on CLASSIC PLUS® Needle Holders & Forceps are guaranteed for five (5) years of normal use.

All STELLITE inserts on CLASSIC PLUS® scissors are guaranteed for ten (10) years of normal use.

Electrical products are sold with product inserts and/or owner's manuals and additional warranty information is contained therein. For disposable and silicone products, in addition to the warranty printed on this page, the products are warranted to be in a sterile condition if the package in which the product is contained is intact in its original sealed condition. For specific warranty information contact your local Symmetry Surgical sales representative or call Customer Service.

WARRANTY REMEDY

Any product which proves defective in workmanship or materials will be repaired or replaced at our discretion free of charge. Please contact our Customer Service team at 1.800.251.3000 (US) or +41 (0) 52 557 59 00 to report a warranty return.

LIMITATIONS

Alteration, repair, modification or removal of lot numbers of any product which is performed by persons not authorized by Symmetry Surgical will result in immediate voiding of warranty.

Sterilization by unapproved methods will result in immediate voiding of warranty.

Terms & Conditions of Sale

EXCLUSION OF OTHER WARRANTIES AND REMEDIES

Except for the express warranty referenced above, Symmetry Surgical disclaims all other warranties, express or implied, including the implied warranty of merchantability and fitness for a particular purpose. The stated warranty and remedy provided are exclusive and in lieu of all other warranties and remedies provided by law.

LIMITATION OF LIABILITY FOR DAMAGES

Symmetry Surgical shall not in any case, be liable for direct, indirect, special, incidental or consequential damages arising from breach of warranty, breach of contract, negligence, or any other legal theory. Such damages include but are not limited to, punitive or exemplary damages, loss of profits or revenues, loss of use of the product or any associated equipment, cost of capital, cost of any substitute product, facilities or services, down-time costs, lost reputation, or claims of buyers for such damages. The limit of Symmetry Surgical's liability to Buyer for any Product(s) sold or services provided is limited to the amount paid by Buyer for the Product(s) that are the subject of any particular claim by Buyer against Symmetry Surgical.

Products offered by Symmetry Surgical are not available in every market.



About Symmetry Surgical

About Symmetry Surgical

Symmetry Surgical is dedicated to developing high-quality surgical instruments that respond to clinicians' needs as they arise, making a real difference in the lives of patients.

Our broad portfolio also brings together the rich history and distinctive product lines of the recently acquired stainless steel and titanium surgical instruments of Codman*, the surgical instruments of Specialty Surgical Instrumentation (SSI) and the electrosurgery instruments of Olsen® Medical.

Offering one of the most comprehensive suites of surgical instruments in the industry, we continue to collaborate with clinicians, global medical device manufacturers and thousands of hospitals to provide solutions for today's needs and tomorrow's growth.

Headquartered just outside of Nashville, TN with an international office in Schaffhausen, Switzerland, Symmetry Surgical is a wholly owned subsidiary of Symmetry Medical Inc. (NYSE:SMA).

Simplifying Global Business

Symmetry Surgical understands the global marketplace and has a dedicated international team, including international customer service representatives, international business specialists, and international sales specialists. We have local representation through a network of authorized distributors or direct sales representatives in practically every nation.

If you would like more information on authorized sales agents in your country, please contact: internationalorders@symmetrysurgical.com
Our international team is dedicated to supporting and managing the business efforts of our global customers and distributors—providing service that exceeds expectations.

*Please note: Codman & Shurtleff, Inc. continues to be one of the largest neurosurgery, neurovascular and neuromodulation companies in the world. Symmetry's acquisition pertained only to Codman's reusable stainless steel and titanium surgical instrument and retractor systems, sterile disposable surgical products (vein strippers, SECTO® dissectors, tonsil sponges and surgical marker pens), and sterilization containers.

Continuing Education

We are passionate about collaborating with our clinical partners and providing Continuing Education (CE) Workshops and Training Programs for CE Credit on a variety of topics. We believe that sharing educational courses that assist our customers in their daily practice is an important way to keep our relationship strong and to share our mutual goal of exceptional patient care.

The Making of a Surgical Instrument

Symmetry Surgical has a dedicated facility and team in Tuttlingen, Germany, the global center for high-quality surgical instrument manufacturers. Instruments are manufactured in conformance with proven processes that combine the latest technologies with the time-honored traditions that are the foundation of the craft of instrument manufacturing.

Well trained and experienced surgical instrument makers produce the instruments by hand. Masters in their profession, instrument makers fine-tune each instrument before it is shipped to our inspection and receiving site, where each receives a thorough review for quality and fine craftsmanship.

Suture Chart

Suture Size (mm)

10	9.0	8.0	7.0	6.0	5.0	4.0	3.0	2.0	1.0	CODE	DESCRIPTION
			●	●	●	●	●	●		36-2010	Baugarther Needle Holder
			●	●	●					32-440	Castroviejo Needle Holder
			●	●	●					32-441	Castroviejo Needle Holder
			●	●	●					32-442	Castroviejo Needle Holder
			●	●	●					32-444	Castroviejo Needle Holder
			●	●						36-1000	Castroviejo Needle Holder
			●	●						36-1001	Castroviejo Needle Holder
			●	●						36-1002	Castroviejo Needle Holder
			●	●						36-1003	Castroviejo Needle Holder
			●	●						36-1005	Castroviejo Needle Holder
			●	●						36-1006	Castroviejo Needle Holder
			●	●						36-1007	Castroviejo Needle Holder
			●	●						36-1008	Castroviejo Needle Holder
							●	●	●	32-439	Castroviejo (Jacobson Style) Heavy Needle Holder
							●	●	●	32-449	Castroviejo (Jacobson Style) Heavy Needle Holder
			●	●	●					32-446	Castroviejo (Jacobson Style) Needle Holder
				●	●					55-2533T	Castroviejo Titanium Needle Holder
				●	●					55-2534T	Castroviejo Titanium Needle Holder
				●	●					55-2538T	Castroviejo Titanium Needle Holder
			●	●	●					32-454	Castroviejo-Ryder Needle Holder
			●	●	●					32-455	Castroviejo-Ryder Needle Holder
			●	●	●					32-456	Castroviejo-Ryder Needle Holder
				●	●					32-458	Cooley Needle Holder
						●	●			32-350L	Crile Wood Needle Holder
						●	●			32-310	Crile Wood Needle Holder
						●	●			32-320	Crile Wood Needle Holder
						●	●			32-325	Crile Wood Needle Holder
						●	●			32-330	Crile Wood Needle Holder
						●	●			32-350	Crile Wood Needle Holder
						●	●			32-360	Crile Wood Needle Holder
						●	●			32-365	Crile Wood Needle Holder
						●	●			32-430	Crile Wood Needle Holder
						●	●			32-435	Crile Wood Needle Holder
				●	●	●				36-2000	Crile Wood Needle Holder
				●	●	●				36-2001	Crile Wood Needle Holder
				●	●	●				36-2002	Crile Wood Needle Holder
				●	●	●				36-2003	Crile Wood Needle Holder
				●	●	●				36-2004	Crile Wood Needle Holder
				●	●	●				36-2005	Crile Wood Needle Holder
						●	●			32-010	DeBakey Needle Holder
						●	●			32-030	DeBakey Needle Holder
						●	●			32-040	DeBakey Needle Holder
				●	●					32-001	DeBakey Ultra Light Needle Holder
				●	●					32-002	DeBakey Ultra Light Needle Holder
				●	●					32-003	DeBakey Ultra Light Needle Holder
				●	●					32-004	DeBakey Ultra Light Needle Holder
		●	●	●						32-450	Deithrich Needle Holder
		●	●	●						32-451	Deithrich Needle Holder
		●	●	●						32-453	Deithrich Needle Holder
				●	●	●				32-400	Derf (Webster) Needle Holder
				●	●	●				32-400L	Derf (Webster) Needle Holder

Suture Chart

Suture Size (mm)

10	9.0	8.0	7.0	6.0	5.0	4.0	3.0	2.0	1.0	CODE	DESCRIPTION
				●	●					36-1010	Derf Needle Holder
			●	●	●					55-2604	Double Action Needle Holder
			●	●	●					55-2608	Double Action Needle Holder
			●	●	●					55-2610	Double Action Needle Holder
			●	●	●					55-2612	Double Action Needle Holder
		●	●	●						32-152	Euphrate-Pasque Needle Holder
		●	●	●						32-153	Euphrate-Pasque Needle Holder
		●	●	●						32-154	Euphrate-Pasque Needle Holder
		●	●	●						32-155	Euphrate-Pasque Needle Holder
		●	●	●						32-156	Euphrate-Pasque Needle Holder
							●	●	●	32-200	French Eye Needle Holder
							●	●	●	32-210	French Eye Needle Holder
							●	●		32-425	Gillies Needle Holder And Scissor Holder
				●	●					32-410	Halsey Needle Holder
				●	●					32-415	Halsey Needle Holder
				●	●					36-1015	Halsey Needle Holder
				●	●					36-3016	Halsey Needle Holder
							●	●	●	32-230	Heaney Needle Holder
							●	●	●	32-235	Heaney Needle Holder
							●	●	●	32-239	Heaney Needle Holder
							●	●	●	32-230L	Heaney Needle Holder
							●	●	●	32-236	Heaney Needle Holder
						●	●	●		36-4010	Heaney Needle Holder
					●	●	●			32-326	Intracardiac (Ryder) Needle Holder
					●	●	●			32-366	Intracardiac (Ryder) Needle Holder
					●	●	●			32-368	Intracardiac (Ryder) Needle Holder
							●	●	●	32-470	Jacobson Heavy Needle Holder
							●	●	●	32-471	Jacobson Heavy Needle Holder
							●	●	●	32-473	Jacobson Heavy Needle Holder
						●	●			32-489	Jacobson Needle Holder
						●	●			32-490	Jacobson Needle Holder
						●	●			32-491	Jacobson Needle Holder
						●	●			32-495	Jacobson Needle Holder
						●	●			32-497	Jacobson Needle Holder
				●	●					55-2549	Jacobson Micro Needle Holder
						●	●			32-488	Jacobson Micro Needle Holder
						●	●			32-492	Jacobson Micro Needle Holder
						●	●			32-493	Jacobson Micro Needle Holder
		●	●							55-2527	Jacobson Micro Needle Holder
		●	●							55-2528	Jacobson Micro Needle Holder
		●	●							55-2531	Jacobson Micro Needle Holder
		●	●							55-2532	Jacobson Micro Needle Holder
		●	●							55-2540	Jacobson Micro Needle Holder
		●	●							55-2541	Jacobson Micro Needle Holder
		●	●							55-2727	Jacobson Micro Needle Holder
		●	●							55-2728	Jacobson Micro Needle Holder
				●	●					55-2424T	Jacobson Micro Titanium Needle Holder
				●	●					55-2524T	Jacobson Micro Titanium Needle Holder
				●	●					55-2530T	Jacobson Micro Titanium Needle Holder
				●	●					55-2423T-F	Jacobson Micro Titanium Needle Holder
				●	●					55-2523T-F	Jacobson Micro Titanium Needle Holder

Suture Chart

Suture Size (mm)

10	9.0	8.0	7.0	6.0	5.0	4.0	3.0	2.0	1.0	CODE	DESCRIPTION
●	●	●	●							80-1726	Rhoton® Needle Holder
●	●	●	●							80-1727	Rhoton® Needle Holder
●	●	●	●							80-1728	Rhoton® Needle Holder
●	●	●	●							80-1729	Rhoton® Needle Holder
			●	●	●					36-2024	Rubio Needle Holder
						●	●	●	●	36-2023	Rubio Wire Holding Clamp
		●	●	●						55-2660	Ryder Needle Holder
			●	●	●					32-465	Ryder Needle Holder
			●	●	●					32-466	Ryder Needle Holder
			●	●	●					32-467	Ryder Needle Holder
			●	●	●					32-468	Ryder Needle Holder
			●	●	●					32-468S	Ryder Needle Holder
			●	●	●					32-469	Ryder Needle Holder
			●	●	●					32-467L	Ryder Needle Holder
			●	●	●					32-467XL	Ryder Needle Holder
			●	●	●					32-472	Ryder Needle Holder
			●	●	●					55-2662	Ryder Needle Holder
			●	●	●					55-2664	Ryder Needle Holder
				●	●	●				36-3000	Ryder Needle Holder
				●	●	●				36-3001	Ryder Needle Holder
				●	●	●				36-3002	Ryder Needle Holder
				●	●	●				36-3003	Ryder Needle Holder
				●	●	●				36-3004	Ryder Needle Holder
				●	●	●				36-3005	Ryder Needle Holder
			●							36-3012	Ryder Needle Holder (1.0 mm Tip)
			●							36-3013	Ryder Needle Holder (1.0 mm Tip)
			●							36-3014	Ryder Needle Holder (1.0 mm Tip)
			●							36-3015	Ryder Needle Holder (1.0 mm Tip)
			●							36-3023	Ryder Needle Holder (1.0 mm Tip)
			●							36-3022	Ryder Needle Holder (1.0 mm Tip)
			●							36-3007	Ryder Needle Holder (1.0 mm Tip)
			●							36-3008	Ryder Needle Holder (1.0 mm Tip)
			●							36-3009	Ryder Needle Holder (1.0 mm Tip)
						●	●			32-340	Sarot Needle Holder
						●	●			32-342	Sarot Needle Holder
						●	●			32-344	Sarot Needle Holder
				●	●					36-2020	Sarot Needle Holder
				●	●					36-3021	Sarot Needle Holder
				●	●		●	●	●	36-2025	Sternal Needle Holder
			●	●	●					36-4015	Stratte Needle Holder
			●	●						32-460	Sweden Needle Holder
		●	●							55-2513	Ultra™ Micro Needle Holder
		●	●							55-2515	Ultra™ Micro Needle Holder
			●	●	●					55-2518	Ultra™ Micro Needle Holder
			●	●	●					55-2519	Ultra™ Micro Needle Holder
			●	●	●					55-2520	Ultra™ Micro Needle Holder
			●	●	●					55-2521	Ultra™ Micro Needle Holder
			●	●	●					55-2522	Ultra™ Micro Needle Holder
			●	●	●					36-4020	Wagensteen Needle Holder
				●	●	●				32-405	Webster Needle Holder
				●	●	●				32-405L	Webster Needle Holder



Scan the code above to learn more about our Cardiovascular/Thoracic portfolio.

Cardiovascular/ Thoracic Portfolio



symmetry surgical™

Cardiovascular/Thoracic



Approximators	CVT-2	Punches	CVT-136
Cannulas	CVT-3	Raspatory	CVT-137
Clamps	CVT-3	Retractors	CVT-138
Containers	CVT-55	Rib Spreader	CVT-186
Cords	CVT-63	Rongeurs	CVT-187
Cups	CVT-63	Saws	CVT-188
Dilators	CVT-64	Scissors	CVT-188
Dissectors	CVT-68	Shears	CVT-216
Elevators	CVT-70	Spatulas	CVT-218
Forceps	CVT-71	Spreaders	CVT-218
Hooks	CVT-121	Stringers	CVT-220
Knife Handles	CVT-121	Strippers	CVT-222
Knives	CVT-122	Suction Tubes	CVT-223
Loops	CVT-122	Sump Suction	CVT-225
Markers	CVT-122	Tourniquets	CVT-225
Needle Holders	CVT-123	Trocars	CVT-225
Needles	CVT-135	Tunnelers	CVT-226
Obturator	CVT-135	Valvulotomes	CVT-227
Pliers	CVT-135	Wire & Pin Cutters	CVT-227

Questions? Contact us at customerservice@symmetrysurgical.com or learn more at symmetrysurgical.com



The Surgical Instrument Desk Reference

How to Use Our Catalog

The Symmetry Surgical catalog is designed with you in mind, to be your trusted resource for surgical instrumentation. We took great care in creating an easy-to-use, robust catalog and we think you'll be pleased with the design as you become more familiar with our broad portfolio.

Layout

The catalog is organized by surgical specialty *and* product function.

And we know that it is difficult to pick up an instrument and know what specialty it's listed in. To make your job easier, we've sorted the instruments in our portfolio by surgical function, too, including Energy, Laparoscopic, Retractors and Sterilization Solutions.

U.S. Customer Service

Your Symmetry Surgical Customer Service team wants to make ordering surgical instruments the easiest part of your day. We accept orders via phone, fax, email, our website, Global Healthcare Exchange (GHX) and through the mail.

PHONE

1.800.251.3000

(Available Monday through Friday, 8:30 AM–6:30 PM EST)

FAX

1.800.342.3272

EMAIL

customerservice@symmetrysurgical.com

ONLINE

symmetrysurgical.com

MAILING ADDRESS

Symmetry Surgical
Attn: Customer Service
3034 Owen Drive
Antioch, TN 37013

The Surgical Instrument Desk Reference

International Customer Service

PHONE

Symmetry Surgical Switzerland GmbH
+41 (0) 52 557 59 00
(Available Monday through Friday, 7:00-16:00 GMT)

Symmetry Surgical, Inc., USA
1.615.964.5672
(Available Monday through Friday, 8:30 AM-6:30 PM EST)

FAX

Symmetry Surgical Switzerland GmbH
+41 (0) 52 557 59 99

EMAIL

customerservice@symmetrysurgical.com
internationalorders@symmetrysurgical.com

ONLINE

symmetrysurgical.com

MAILING ADDRESS

Symmetry Surgical Switzerland GmbH
Bühlstrasse 27
CH-8200 Schaffhausen
Switzerland

Symmetry Surgical, Inc.
3034 Owen Drive
Antioch, TN 37013

INTERNATIONAL PAYMENT TERMS/RETURN GOODS POLICY/INSTRUMENT REPAIR & RESTORE PROGRAM/LITERATURE REQUESTS

Please contact your local distributor. Locate a local distributor contact, International Customer Service at +41 (0) 52 557 59 00 or 1.615.964.5672 (US).

Cardiovascular/Thoracic

Energy

Ear, Nose & Throat

General

Laparoscopic

Neurology

Obesity

OB/GYN

Ophthalmology

Orthopedics & Arthroscopy

Pediatrics

Rectal

Retractors

Spine

Urology

Sterilization Solutions

Alphabetical & Numeric Indexes

Approximators (Rib)



Bailey Rib Approximator

Sharp Teeth

CODE	DESCRIPTION	LENGTH	CODE	DESCRIPTION	LENGTH
54-2530	Pediatric	5 $\frac{3}{4}$ in 146 mm	54-2540	Adult	6 $\frac{3}{4}$ in 171 mm



Bailey-Gibbon Rib Approximator

Sharp Teeth

CODE	DESCRIPTION	LENGTH
54-2550S	With Extended 3-Prong Blades	6 $\frac{3}{4}$ in 171 mm



Bailey-Gibbon Rib Approximator

Ratchet Action, Extended Blades, Blunt

CODE	BLADE LENGTH	TOTAL OPENING	LENGTH
50-8055	1 $\frac{3}{4}$ in 44 mm	4 $\frac{5}{8}$ in 117 mm	7 $\frac{1}{8}$ in 181 mm

Cannulas (I.M.A.)

Heparin I.M.A. Cannula

CODE	DESCRIPTION	LENGTH
54-5998	1.5 mm	2 1/8 in 54 mm



Clamps (Abdominal Aorta)

DeBakey Abdominal Aorta Clamp

DeBakey Teeth

CODE	TEETH	JAWS	LENGTH
55-6059	2x3	55 mm	10 1/2 in 267 mm
55-6060	1x2	50 mm	9 in 229 mm



Zanger Abdominal Aorta Clamp

DeBakey Teeth

CODE	DESCRIPTION	LENGTH
55-6114	Curved Shanks	9 in 229 mm
55-6115	Curved Shanks	9 1/2 in 241 mm
55-6116	Curved Shanks	12 1/4 in 311 mm
55-6129	Shanks Angled 90°	9 1/2 in 241 mm
55-6128	Shanks Angled 90°	12 1/4 in 311 mm

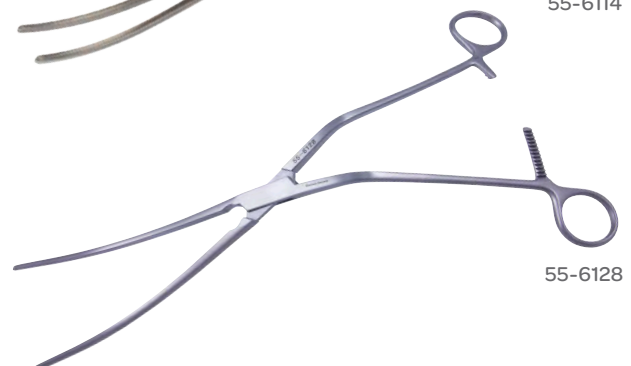
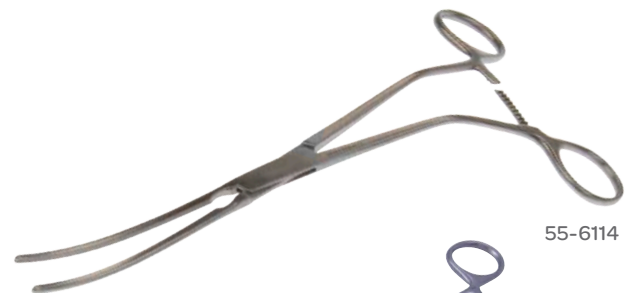

Clamps (Abdominal Aortic Aneurysm)

Grant Abdominal Aortic Aneurysm Clamp

2 x 3 DeBakey Jaws

CODE	JAW LENGTH	LENGTH
55-6139	45 mm	9½ in 241 mm
55-6124	65 mm	10½ in 267 mm

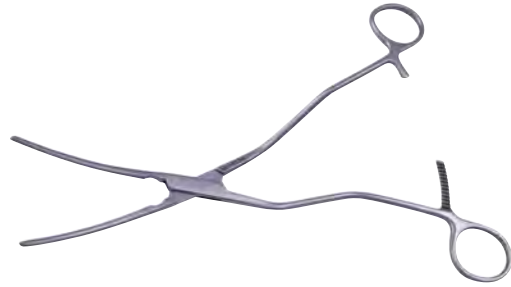

55-6139

Clamps (Acutely)

Cooley Classic® Acutely Curved Clamp

Curved Blades Calibrated at 5.0 mm Intervals, 2 x 2 Vascular Teeth

CODE	DESCRIPTION	JAW LENGTH	JAW DEPTH	LENGTH
37-1310	Medium	1¼ in 38 mm	⅝ in 15 mm	6½ in 165 mm
37-1311	Large	1¾ in 45 mm	¾ in 20 mm	6⅞ in 174 mm



37-1310

Clamps (Acutely Angled Aortic Aneurysm)

Howard Acutely Angled Aortic Aneurysm Clamp

Shanks Angled 90°, DeBakey Jaw

CODE	TEETH	JAW	LENGTH
55-6061	1 x 2 Teeth	105 mm	11¾ in 298 mm
55-6062	2 x 3 Teeth	105 mm	11¾ in 298 mm



55-6061

Clamps (Acutely Curved)

Cooley Acutely Curved Clamp

Angled Shanks, Jaws Calibrated at 5.0 mm Intervals

CODE	DESCRIPTION	LENGTH
55-5023	Small Jaws	6½ in 165 mm

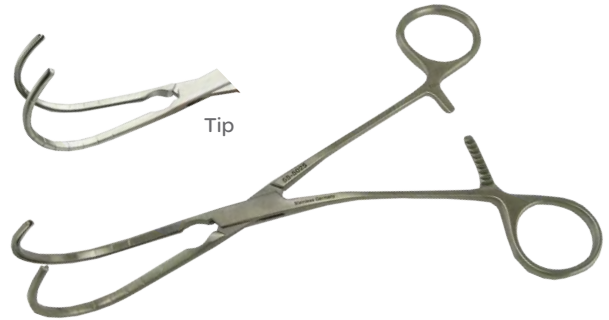

DeBakey Acutely Curved Clamp

CODE	DESCRIPTION	LENGTH
55-6031	Small Jaw	9⅝ in 244 mm
55-6032	Large Jaw	10 in 254 mm

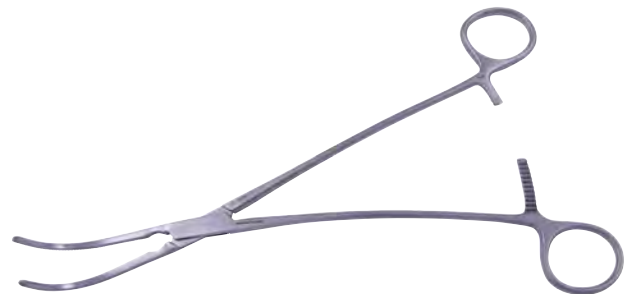

55-6031

Clamps (Anastomosis)

Anastomosis Clamp

Titanium, Angled Shanks

CODE	DESCRIPTION	LENGTH
55-5020T	Angled Jaws	6¼ in 159 mm



Clamps (Anastomosis)

Anastomosis Classic® Clamp

Blades Calibrated at 5.0 mm Intervals, 2 x 2 Vascular Teeth

CODE	JAW LENGTH	JAW DEPTH	LENGTH
37-1225	1 $\frac{5}{8}$ in 41 mm	$\frac{3}{4}$ in 19 mm	6 $\frac{1}{2}$ in 165 mm



Bartley Classic® Anastomosis Clamp

Blades Calibrated at 5.0 mm Intervals, 2 x 2 Vascular Teeth

CODE	JAW LENGTH	JAW DEPTH	LENGTH
37-1305	1 in 25 mm	$\frac{1}{2}$ in 13 mm	5 $\frac{1}{2}$ in 140 mm



Castaneda Anastomosis Clamp

CODE	JAW LENGTH	JAW DEPTH	LENGTH
30-9003	$\frac{5}{8}$ in 16 mm	$\frac{1}{5}$ in 5.0 mm	6 in 152 mm
30-9004	$\frac{3}{4}$ in 19 mm	$\frac{1}{4}$ in 6.0 mm	6 in 152 mm
30-9005	$\frac{7}{8}$ in 22 mm	$\frac{1}{3}$ in 8.0 mm	6 in 152 mm



30-9003

Clamps (Anastomosis)

Cooley Anastomosis Clamp

Jaws Calibrated at 5.0 mm Intervals

CODE	DESCRIPTION	LENGTH
55-6009	Standard Jaw	6 ½ in 165 mm
55-6011	Slender Jaw	6 ½ in 165 mm



55-6011

Cooley Classic® Anastomosis Clamp

Modified, 30° Side Angle, Blades Calibrated at 5.0 mm Intervals, 2 x 2 Vascular Teeth

CODE	JAW LENGTH	JAW DEPTH	LENGTH
37-1230	¾ in 19 mm	¼ in 6.0 mm	6 ½ in 165 mm

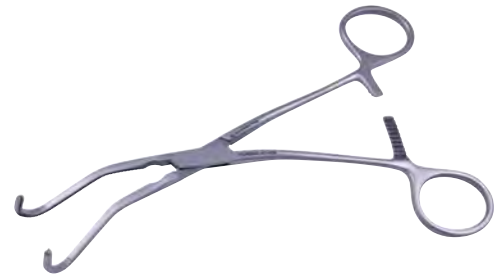

Cooley Opti-Length® Anastomosis Clamp

CODE	DESCRIPTION	LENGTH
67-7564	Anastomosis Clamp	12 in 305 mm

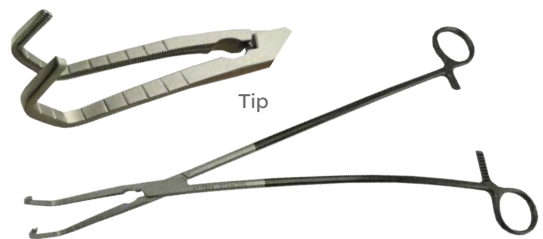

Cooley-Derra Anastomosis Clamp

CODE	DESCRIPTION	LENGTH
55-6001	Small Jaws	6 ½ in 165 mm
55-6002	Medium Jaws	6 ½ in 165 mm

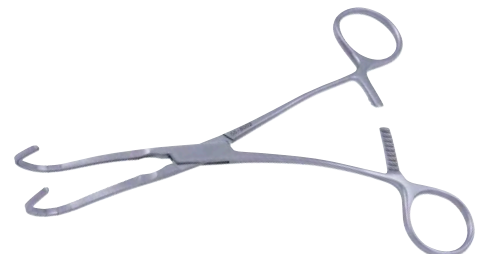

55-6002

Clamps (Vascular)

Cooley-Derra Classic® Anastomosis Clamp

Blades Calibrated at 5.0 mm Intervals, Slightly Curved Shafts, 2 x 2 Vascular Teeth

CODE	JAW LENGTH	JAW DEPTH	LENGTH
37-1302	1 ³ / ₄ in 44 mm	½ in 13 mm	7 in 178 mm



DeBakey-Derra Anastomosis Clamp

CODE	DESCRIPTION	LENGTH
55-6004	Small Jaws	6½ in 165 mm



Derra Anastomosis Clamp

1 x 2 Vascular Teeth

CODE	JAW LENGTH	JAW DEPTH	LENGTH
37-1221	1 in 25 mm	½ in 13 mm	6½ in 165 mm
37-1222	1 in 25 mm	½ in 13 mm	6¾ in 171 mm

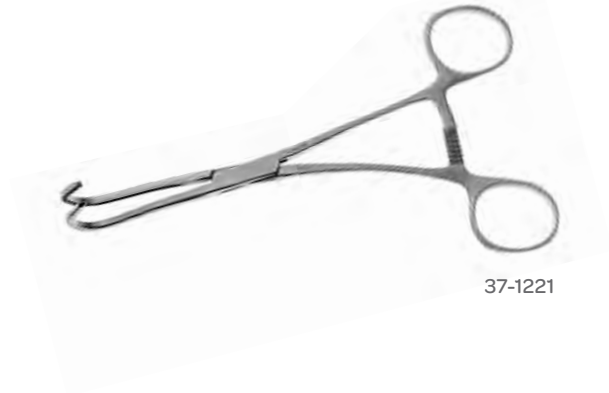

37-1221

DeBakey Aneurysm Clamp

1 x 2 Vascular Teeth

CODE	JAW LENGTH	LENGTH
37-1141	3 ³ / ₈ in 86 mm	10½ in 267 mm
37-1142	4 in 102 mm	12 in 305 mm
37-1143	4¾ in 121 mm	12½ in 318 mm



37-1141

Clamps (Aorta)

DeBakey-Bahnson Aorta Clamp

CODE	DESCRIPTION	LENGTH
55-6122	Slight Curve	10 in 254 mm



Beck Aorta Clamp

CODE	DESCRIPTION	JAW
55-5998	Aorta Clamp	1 1/8 in 29 mm



Cooley Aorta Clamp

CODE	DESCRIPTION	LENGTH
55-6064T	Titanium, Jaws 72 mm, 18 mm Deep	10 3/4 in 273 mm
37-1400	1 x 2 Vascular Teeth, Jaw Length 2 2/3 in (73 mm), Jaw Depth 1 1/16 in (27 mm)	10 1/2 in 267 mm

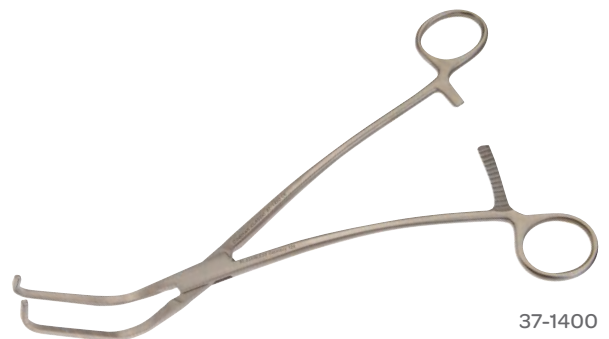

Cooley Aorta Aneurysm Clamp

CODE	DESCRIPTION	LENGTH
55-6008	Slightly Curved Jaws	10 3/4 in 273 mm

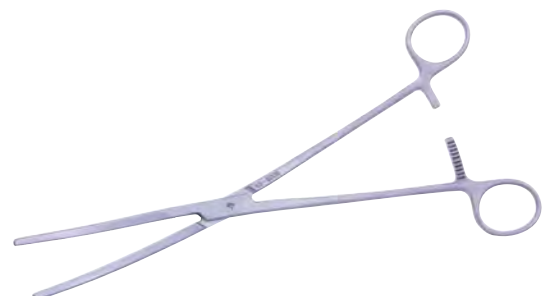

Clamps (Aorta)

DeBakey Aorta Exclusion Clamp

Acute S-Shape, 1 x 2 Vascular Teeth

CODE	JAW LENGTH		LENGTH	
37-1120	3 in	76 mm	7½ in	191 mm



DeBakey Aorta Aneurysm Clamp

CODE	TEETH	JAW LENGTH		LENGTH	
37-1140	1x2 Vascular Teeth	3 in	76 mm	9 in	229 mm
55-6055	2x3 DeBakey Teeth	4 in	102 mm	12 in	305 mm



37-1140

DeBakey-Bahnson Aorta Clamp

CODE	DESCRIPTION	LENGTH	
55-6121	Medium Curve	9½ in	241 mm



Diethrich Aorta Clamp

CODE	JAW LENGTH		JAW DEPTH	LENGTH
37-1015	1¾ in	44 mm	5⁄8 in 16 mm	8¾ in 213 mm



Clamps (Aorta)

Howard Aorta Aneurysm Clamp

Reverse Curve Shanks, 1 x 2 Teeth, DeBakey Jaw

CODE	TEETH	JAW	LENGTH
55-6057	1 x 2 Teeth	105 mm	11 ³ / ₄ in 298 mm



Kay Aorta Anastomosis Clamp

CODE	TEETH	JAW (W X D)	LENGTH
55-6065	DeBakey Teeth	45 x 32 mm	8 in 203 mm



Lambert-Kay Aorta Clamp

1 x 2 Vascular Teeth

CODE	JAW LENGTH	JAW DEPTH	LENGTH
37-1025	2 in 51 mm	³ / ₄ in 19 mm	7 ³ / ₄ in 197 mm



Mattox Aorta Clamp

1 x 2 Vascular Teeth, Angled Handles

CODE	JAW LENGTH	LENGTH
37-1021	3 in 76 mm	8 ³ / ₄ in 222 mm



Clamps (Aorta)

Mitchell Aorta Clamp

CODE	JAW	LENGTH
55-6113	25 mm	8 in 203 mm



Morris Aorta Clamp

2x3 Vascular Teeth

CODE	JAW LENGTH	LENGTH
37-1700	3 in 76 mm	7 ³ / ₄ in 197 mm
37-1701	3 in 76 mm	10 ³ / ₈ in 264 mm



Ochsner Aorta Clamp

1x2 Vascular Teeth

CODE	JAW LENGTH	JAW DEPTH	LENGTH
37-1026	2 ¹ / ₈ in 54 mm	³ / ₄ in 19 mm	10 ³ / ₈ in 264 mm



Parsonnet Aorta Clamp

CODE	JAW LENGTH	LENGTH
55-6145	1 ¹ / ₄ in 32 mm	10 ¹ / ₄ in 260 mm

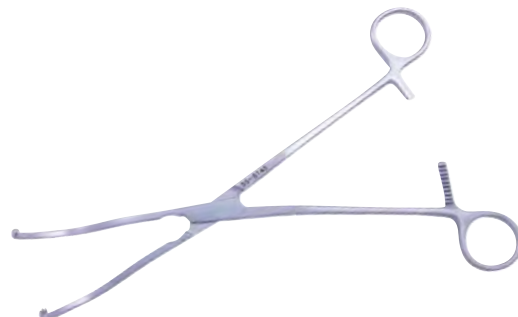

Clamps (Aorta)

Reul Aorta Clamp

2 x 3 Vascular Teeth

CODE	JAW LENGTH	JAW DEPTH	LENGTH
37-1024	2 1/8 in 54 mm	5/8 in 16 mm	10 in 254 mm



Strong Aortic Clamp

DeBakey Teeth

CODE	DESCRIPTION	JAWS (W X D)	LENGTH
55-6110	Angled	41 x 16 mm	8 in 203 mm
55-6108	Straight	41 x 16 mm	8 in 203 mm



55-6110

Beck Miniature Aorta Clamp

Straight Shanks

CODE	DESCRIPTION	LENGTH
55-5038	DeBakey Jaws	6 3/4 in 171 mm



Subramanian Mini Aorta Clamp

CODE	DESCRIPTION	LENGTH
55-5035	Mini Aorta Clamp	5 1/2 in 140 mm



Clamps (Approximator)



B-2AB

Approximator Clamp

For Thick Walled Arteries (Sold In Pairs Only)

CODE	DESCRIPTION	VESSEL DIAMETER	CODE	DESCRIPTION	VESSEL DIAMETER
B-1A	Single Clamp	0.4–1.0 mm	B-1AB	Black Single Clamp	0.4–1.0 mm
B-2A	Single Clamp	0.6–1.5 mm	B-2AB	Black Single Clamp	0.6–1.5 mm
B-3A	Single Clamp	1.0–2.25 mm	B-3AB	Black Single Clamp	1.0–2.25 mm



BB-1A

Approximator Clamp

With Frames, For Thick Walled Arteries

CODE	DESCRIPTION	VESSEL DIAMETER	CODE	DESCRIPTION	VESSEL DIAMETER
BB-1A	Double Clamp	0.4–1.0 mm	BB-1AB	Black Double Clamp	0.4–1.0 mm
BB-2A	Double Clamp	0.6–1.5 mm	BB-2AB	Black Double Clamp	0.6–1.5 mm
BB-3A	Double Clamp	1.0–2.25 mm	BB-3AB	Black Double Clamp	1.0–2.25 mm



ABB-11A

Approximator Clamp

Without Frames, for Thick Walled Arteries

CODE	DESCRIPTION	VESSEL DIAMETER	CODE	DESCRIPTION	VESSEL DIAMETER
ABB-11A	Double Clamp	0.4–1.0 mm	ABB-11AB	Black Double Clamp	0.4–1.0 mm
ABB-22A	Double Clamp	0.6–1.5 mm	ABB-22AB	Black Double Clamp	0.6–1.5 mm
ABB-33A	Double Clamp	1.0–2.25 mm	ABB-33AB	Black Double Clamp	1.0–2.25 mm

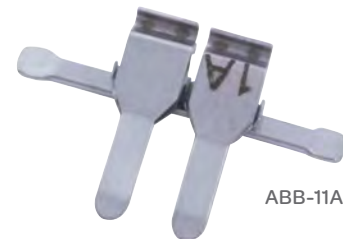
Clamps (Approximator)

Clamp Applying Forceps

Without Lock, 5 ½ in (140 mm)

CODE	DESCRIPTION	CODE	DESCRIPTION
78-0095	For Clamp Sizes B-1,B-2	78-0096	For Clamp Sizes B-3



Approximator Clamp

With Frames, for Thick Walled Arteries

CODE	DESCRIPTION	VESSEL DIAMETER	CODE	DESCRIPTION	VESSEL DIAMETER
ABB-1A	Double Clamp	0.4–1.0 mm	ABB-1AB	Black Double Clamp	0.4–1.0 mm
ABB-2A	Double Clamp	0.6–1.5 mm	ABB-2AB	Black Double Clamp	0.6–1.5 mm
ABB-3A	Double Clamp	1.0–2.25 mm	ABB-3AB	Black Double Clamp	1.0–2.25 mm

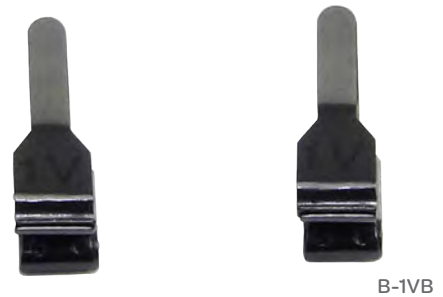

General Purpose Clamp, for Arteries & Veins

Sold In Pairs Only

Sold as Each

CODE	DESCRIPTION	VESSEL DIAMETER	CODE	DESCRIPTION	VESSEL DIAMETER
DC-1	Angled Clamps, Single Clamp	0.4–1.0 mm	BB-1V	Stationary, with Frame, Double Clamp	0.4–1.0 mm
DC-2	Angled Clamps, Single Clamp	0.6–1.5 mm	BB-2V	Stationary, with Frame, Double Clamp	0.6–1.5 mm
DC-3	Angled Clamps, Single Clamp	1.0–2.25 mm	BB-3V	Stationary, with Frame, Double Clamp	1.0–2.25 mm
B-1V	Single Clamps	0.4–1.0 mm			
B-2V	Single Clamps	0.6–1.5 mm			
B-3V	Single Clamps	1.0–2.25 mm			
B-1VB	Black Single Clamp	0.4–1.0 mm			
B-2VB	Black Single Clamp	0.6–1.5 mm			
B-3VB	Black Single Clamp	1.0–2.25 mm			

Clamps (Approximator)



ABB-3VB

Approximator Clamp

Stationary, with Frames

CODE	DESCRIPTION	VESSEL DIAMETER	CODE	DESCRIPTION	VESSEL DIAMETER
ABB-1V	Clamp	0.4–1.0 mm	ABB-1VB	Black Double Clamp	0.4–1.0 mm
ABB-2V	Clamp	0.6–1.5 mm	ABB-2VB	Black Double Clamp	0.6–1.5 mm
ABB-3V	Clamp	1.0–2.25 mm	ABB-3VB	Black Double Clamp	1.0–2.25 mm

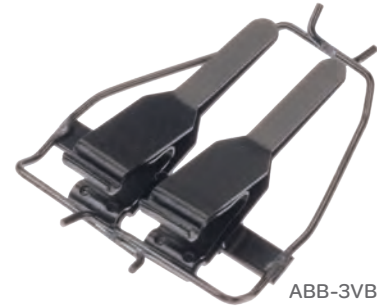

ABB-11VB

Approximator Clamp

Without Frames

CODE	DESCRIPTION	VESSEL DIAMETER	CODE	DESCRIPTION	VESSEL DIAMETER
ABB-11V	Double Clamp	0.4–1.0 mm	ABB-11VB	Black Double Clamp	0.4–1.0 mm
ABB-22V	Double Clamp	0.6–1.5 mm	ABB-22VB	Black Double Clamp	0.6–1.5 mm
ABB-33B	Double Clamp	1.0–2.25 mm	ABB-33VB	Black Double Clamp	1.0–2.25 mm



HD-S

Hand-Applied Approximator Clamp

With Flat Jaws

CODE	DESCRIPTION	VESSEL DIAMETER	CODE	DESCRIPTION	VESSEL DIAMETER
HD-S	Single	1.4–3.5 mm	HD-D	Double	1.4–3.5 mm
RD-S	Single	2.0–5.0 mm	RD-D	Double	2.0–5.0 mm
HD-SB	Black, Single	1.4–3.5 mm	HD-DB	Black, Double	1.4–3.5 mm
RD-SB	Black, Single	2.0–5.0 mm	RD-DB	Black, Double	2.0–5.0 mm

Clamps (Artery)

Dardick Artery Clamp

CODE	JAW LENGTH	LENGTH
55-8690	90°	5 ¼ in 133 mm



Clamps (Auricle)

Glover Classic® Auricle Appendage Clamp

1x2 Vascular Teeth

CODE	JAW LENGTH		JAW DEPTH		LENGTH
37-1105	2 in	51 mm	¼ in	6.0 mm	9 ¾ in 248 mm



Clamps (A-V Fistula)

Noon Classic® A-V Fistula Clamp

1x2 Vascular Teeth

CODE	JAW LENGTH		LENGTH
37-1335	1 in	25 mm	4 ½ in 114 mm



Clamps (Breast)

Adair Breast Clamp

CODE	DESCRIPTION	LENGTH
19-4004	Breast Clamp	7¾ in 197 mm



Clamps (Bronchus)

Lees Bronchus Clamp

CODE	DESCRIPTION	LENGTH
37-1035	1 x 2 Vascular Teeth, Jaw Length 1⅝ in (41 mm)	9½ in 241 mm
55-6600	Right Angle	8½ in 216 mm

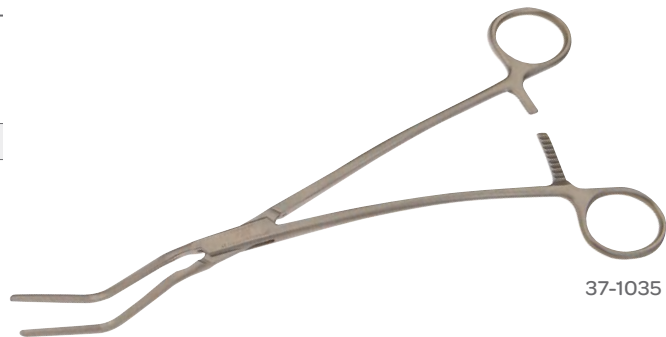

37-1035

Sarot Bronchus Clamp

Toothed Jaw, Left

CODE	JAW LENGTH	LENGTH
19-8167	1½ in 38 mm	9 in 229 mm



Clamps (Bulldog)

DeBakey Classic® Bulldog Clamp

1 x 2 Vascular Teeth, Ring Handle

CODE	ANGLE	JAW LENGTH		LENGTH	
37-1070	Straight	1 in	25 mm	5 3/8 in	137 mm
37-1071	Curved	1 1/2 in	38 mm	5 in	127 mm
37-1072	45°	1 5/8 in	41 mm	5 in	127 mm
37-1073	90°	1 5/8 in	41 mm	3 3/4 in	95 mm



37-1070

Glover Classic® Bulldog Clamp

Curved, 1 x 2 Vascular Teeth

CODE	JAW LENGTH		LENGTH	
37-1054	1 1/16 in	27 mm	2 1/2 in	64 mm
37-1055	1 in	25 mm	3 in	76 mm



37-1054

Gregory Classic® Bulldog Clamp

Straight, 1 x 2 Vascular Teeth, Tension 3.5 lbs, Short

CODE	JAW LENGTH		LENGTH	
37-1060	1 3/16 in	30 mm	3 1/2 in	89 mm



Cooley Bulldog Clamp

CODE	DESCRIPTION	JAW	LENGTH	
37-4024	Straight	20 mm	2 in	51 mm
55-4145	Straight	20 mm	2 in	51 mm
55-4146	Straight	30 mm	2 5/8 in	67 mm
55-4147	Straight	47 mm	3 3/8 in	86 mm
37-4025	Curved	18 mm	1 3/4 in	44 mm
55-4149	Curved	18 mm	1 3/4 in	44 mm
55-4150	Curved	24 mm	2 1/2 in	64 mm
55-4151	Curved	40 mm	3 1/8 in	79 mm



55-4145

Clamps (Bulldog)

DeBakey Bulldog Clamp

Cross-Action, 1 x 2 Vascular Teeth, Tension 6 lbs

CODE	DESCRIPTION	JAW LENGTH	LENGTH
37-1040	Straight	$\frac{3}{4}$ in 19 mm	$3\frac{1}{8}$ in 79 mm
37-1044	Curved	$\frac{3}{4}$ in 19 mm	3 in 76 mm
37-1045	Curved	$1\frac{3}{16}$ in 30 mm	$3\frac{3}{8}$ in 86 mm
37-1046	Curved	$1\frac{3}{4}$ in 44 mm	$4\frac{1}{8}$ in 105 mm



37-1044

Diethrich Bulldog Clamp, Angled

Tension 55 gms

CODE	JAW LENGTH	LENGTH
19-8090	$\frac{1}{2}$ in 13 mm	$1\frac{3}{4}$ in 44 mm
19-8091	$\frac{1}{2}$ in 13 mm	$1\frac{7}{8}$ in 48 mm
19-8095	$\frac{3}{4}$ in 19 mm	2 in 51 mm



19-8090

Diethrich Bulldog Clamp, Straight

Tension 55 gms

CODE	JAW LENGTH	LENGTH
19-8092	$\frac{5}{8}$ in 15 mm	2 in 51 mm
19-8093	$\frac{3}{4}$ in 20 mm	$2\frac{1}{16}$ in 52 mm
19-8094	$\frac{3}{4}$ in 20 mm	$2\frac{1}{16}$ in 52 mm



19-8092

Diethrich Micro-Coronary Bulldog Clamp

CODE	ANGLE	JAW
55-4038	Angled	8.0 mm
55-4039	Angled	12 mm
55-4040	Angled	20 mm



55-4038

Clamps (Bulldog)

Diethrich Modified Tension Bulldog Clamp

Tension 180 gms

CODE	ANGLE	JAW LENGTH	LENGTH
19-8097	Angled	½ in 13 mm	1 7⁄8 in 48 mm
19-8099	Straight	¾ in 19 mm	2 1⁄8 in 54 mm



19-8097

Glover Bulldog Clamp

CODE	DESCRIPTION	LENGTH
55-6082	Angled	
37-1053	Straight, 1 x 2 Vascular Teeth, Jaw Length 2 3⁄8 in (60 mm)	4 1⁄2 in 114 mm



55-6082

Glover Bulldog Clamp

CODE	DESCRIPTION	JAW	LENGTH
55-4011	Straight	20 mm	2 in 51 mm
55-4012	Straight	30 mm	2 1⁄2 in 64 mm
55-4013	Straight	40 mm	3 1⁄2 in 89 mm
55-4015	Curved	20 mm	2 in 51 mm
55-4017	Curved	40 mm	3 1⁄2 in 89 mm
55-4018	Curved	60 mm	4 3⁄4 in 121 mm



55-4015

Gregory Bulldog Clamp

CODE	DESCRIPTION	JAW	LENGTH
55-6191	Straight, Long	45 mm	4 1⁄4 in 108 mm
55-6149	Angled, Straight		4 5⁄8 in 117 mm
55-6192	Angled, Short	30 mm	3 1⁄2 in 89 mm
55-6149L	Curved Left		4 3⁄4 in 121 mm
55-6149R	Curved Right		4 5⁄8 in 117 mm



55-6149

Clamps (Bulldog)

Gregory Internal Carotid Bulldog Clamp

CODE	JAW	LENGTH
55-6148	Long, 2 $\frac{3}{4}$ in (70 mm)	4 $\frac{3}{4}$ in 121 mm



Jacobson Bulldog Clamp

CODE	DESCRIPTION	SERRATED JAW	LENGTH
37-4022	Straight	13 mm	1 $\frac{3}{8}$ in 35 mm
37-4023	Straight	21 mm	1 $\frac{3}{4}$ in 44 mm
37-4026	Curved	13 mm	1 $\frac{1}{4}$ in 32 mm
37-4021	Curved	21 mm	1 $\frac{3}{4}$ in 44 mm



37-4022

Johns Hopkins Bulldog Clamp

CODE	DESCRIPTION	JAW LENGTH	LENGTH
55-4026	Straight		2 $\frac{1}{4}$ in 57 mm
55-4029	Straight		3 in 76 mm
55-4030	Straight		3 $\frac{1}{2}$ in 89 mm
55-4031	Curved		1 $\frac{1}{2}$ in 38 mm
55-4033	Curved		2 $\frac{1}{4}$ in 57 mm
19-8071	Straight, Serrated, Closing Pressure 6 lbs	$\frac{3}{4}$ in 19 mm	2 $\frac{1}{4}$ in 57 mm
19-8080	Curved, Serrated, Closing Pressure 6 lbs	$\frac{3}{8}$ in 10 mm	1 $\frac{1}{2}$ in 38 mm



19-8071

Senning Bulldog Clamp

CODE	DESCRIPTION
55-4054	Very Light, Adjustable Tension Cooley Jaws



Clamps (Bulldog)

Ultra™ Titanium Bulldog Vein Clamp

Lightweight, Corrosion Resistant Atraumatic Teeth, Slight Closing Pressure for Veins

CODE	DESCRIPTION	JAW LENGTH
15-0430	Straight	30 mm
15-0435	Straight	35 mm
15-0440	Straight	40 mm
15-0450	Straight	50 mm
15-0530	Light Curve	30 mm
15-0535	Light Curve	35 mm
15-0540	Light Curve	40 mm
15-0550	Light Curve	50 mm
15-0730	Strong Curve	30 mm
15-0735	Strong Curve	35 mm
15-0740	Strong Curve	40 mm
15-0750	Strong Curve	50 mm



15-0435

Ultra™ Titanium Bulldog Artery Clamp

Lightweight, Corrosion Resistant Atraumatic Teeth, Strong Closing Pressure for Arteries

CODE	DESCRIPTION	JAW LENGTH
15-0431	Straight	30 mm
15-0436	Straight	35 mm
15-0441	Straight	40 mm
15-0451	Straight	50 mm
15-0531	Light Curve	30 mm
15-0536	Light Curve	35 mm
15-0541	Light Curve	40 mm
15-0551	Light Curve	50 mm
15-0731	Strong Curve	30 mm
15-0736	Strong Curve	35 mm
15-0741	Strong Curve	40 mm
15-0751	Strong Curve	50 mm



15-0436

Ultra™ Light Bulldog Clamp

CODE	DESCRIPTION	JAW
55-9510	Angled	10 mm
55-9511	Angled	14 mm



55-9510

Clamps (Carotid)

Kartchner Carotid Clamp

Curved Shanks

CODE	DESCRIPTION	LENGTH	
55-5064	Long Thin Jaw	6 in	152 mm



Thompson Carotid Clamp

CODE	DESCRIPTION	LENGTH	
55-5063	Curved Shanks	6 in	152 mm

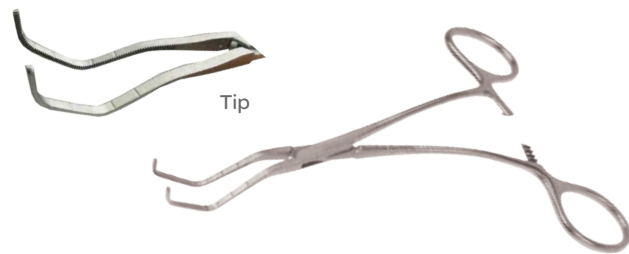

Clamps (Carotid Artery)

Javid Carotid Artery Clamp

CODE	DESCRIPTION	LENGTH	
55-7050	Large, Jaws Close to 6.0 mm Ring	7 1/8 in	181 mm
55-7051	Small, Jaws Close to a 4.0 mm Ring	6 3/4 in	171 mm



Clamps (Caval Occlusion)

Cooley Caval Occlusion Clamps

CODE	DESCRIPTION	LENGTH	
55-7028	24 French	8 1/4 in	210 mm
55-7029	26 French	8 1/4 in	210 mm
55-7033	34 French	8 1/4 in	210 mm

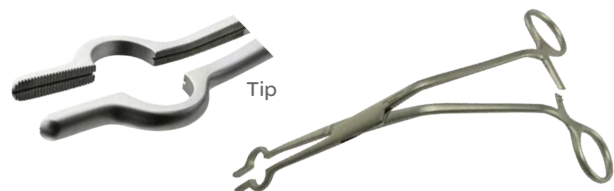

55-7033

Clamps (Chest Tube Puller/Passer)

Chest Tube Puller/Passer

CODE	DESCRIPTION	LENGTH
55-6926	With Ratchet	9 3/4 in 248 mm
55-6928	With Ratchet	14 in 356 mm
55-6925	Without Ratchet	9 3/4 in 248 mm
55-6927	Without Ratchet	14 in 356 mm



55-6925

Clamps (Coarctation)

Cooley Classic® Coarctation Clamp

2 x 2 Vascular Teeth, Calibrated

CODE	DESCRIPTION	SHAFT	JAW LENGTH	LENGTH
37-1260	Straight Jaw	Straight Shaft	1 5/8 in 41 mm	6 3/4 in 171 mm
37-1262	Curved Jaw	Straight Shaft	1 5/8 in 41 mm	6 3/4 in 171 mm
37-1261	Straight Jaw	Angled Shaft	1 5/8 in 41 mm	6 3/4 in 171 mm



37-1260

Cooley Coarctation Clamp

CODE	DESCRIPTION	JAW LENGTH	LENGTH
55-5011	Straight Shanks, Spoon Jaws	Jaws Calibrated at 5.0 mm Intervals	6 3/4 in 171 mm
55-6133	Straight	55 mm	8 3/4 in 222 mm
55-6134	Angled	55 mm	8 3/4 in 222 mm



Crafoord Coarctation Clamp

1 x 2 Vascular Teeth

CODE	JAW LENGTH	LENGTH
19-8104	2 1/2 in 64 mm	9 1/2 in 241 mm



Clamps (Coarctation)

DeBakey Classic® Coarctation & Peripheral Vascular Clamp

Straight, 1 x 2 Vascular Teeth

CODE	JAW LENGTH	LENGTH
37-1150	2 1/8 in 54 mm	8 1/2 in 216 mm



DeBakey Coarctation Clamp

CODE	ANGLE	JAWS	LENGTH
55-6021	Angled	55 mm	9 in 229 mm

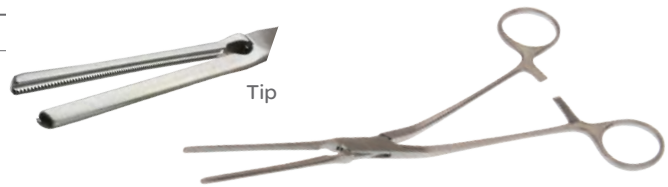

Glover Classic® Coarctation Clamp

Angular, 1 x 2 Vascular Teeth

CODE	JAW LENGTH	LENGTH
37-1091	2 1/8 in 54 mm	8 1/2 in 216 mm



Glover Coarctation Clamp

CODE	DESCRIPTION	LENGTH
55-6016	Straight, DeBakey Jaws	8 3/4 in 222 mm
55-6126	Straight	10 1/2 in 267 mm
55-6127	Angled, Straight Jaw	11 1/2 in 292 mm



55-6016

Clamps (Coarctation)

Glover Opti-Length® Coarctation Clamp

CODE	DESCRIPTION	LENGTH	
67-7525	Straight	10 in	254 mm
67-7526	Curved	10 in	254 mm



DeBakey Miniature Coarctation Clamp

CODE	DESCRIPTION	LENGTH	
55-5068	Straight Jaws	6 in	152 mm

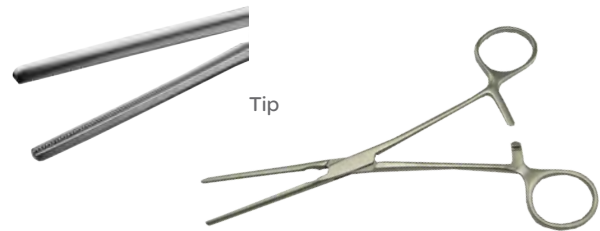

Clamps (Cross-Action Bulldog)

Cooley Cross-Action Bulldog Clamp

CODE	ANGLE	JAW	LENGTH	
55-4047	Straight	49 mm	4 ¼ in	108 mm
55-4048	Straight	68 mm	5 in	127 mm

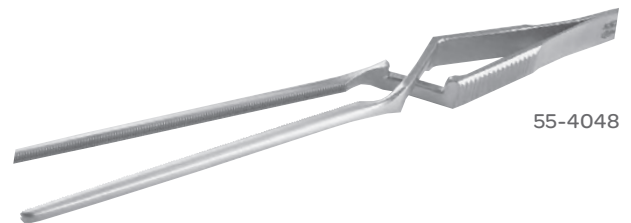

DeBakey Cross-Action Bulldog Clamp

CODE	ANGLE	JAW	LENGTH	
55-4002	Straight	30 mm	3 ½ in	89 mm
55-4004	Straight	45 mm	4 in	102 mm
55-4006	Straight	60 mm	4 ¾ in	121 mm
55-4010	Curved	60 mm	4 ½ in	114 mm

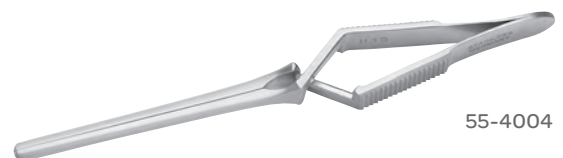

Clamps (Tangential)

DeBakey Tangential Clamp

CODE	JAW LENGTH	JAW DEPTH	LENGTH
37-1190	1 $\frac{5}{8}$ in 41mm	$\frac{1}{2}$ in 13mm	7 $\frac{1}{2}$ in 191mm



Clamps (Delicate)

Classic® Delicate Clamp

CODE	DESCRIPTION	LENGTH
30-4493	Right Angle	5 $\frac{1}{2}$ in 140 mm
30-4494	Right Angle	7 in 178 mm



Gemini Classic® Delicate Clamp

CODE	DESCRIPTION	LENGTH
19-5579	Curved	5 $\frac{1}{2}$ in 140 mm



Bozeman Dressing Forceps

CODE	DESCRIPTION	LENGTH
19-8026	Straight	10 $\frac{3}{4}$ in 273 mm



Clamps (Ductus)

Glover Ductus Clamp

CODE	DESCRIPTION	LENGTH	
37-1086	Angled	8 in	203 mm



Clamps (Femoral Popliteal)

Dale Femoral Popliteal Clamp

CODE	DESCRIPTION	LENGTH	
55-6099	Small	6 3/4 in	171 mm
55-6101	Large	7 1/4 in	184 mm



55-6099

Clamps (Hemagrip)

“Fogarty Type” Hemagrip Clamp

CODE	DESCRIPTION	JAW	LENGTH	
55-7525	Angled	33 mm	4 5/8 in	117 mm
55-7545	Angled	61 mm	8 1/2 in	216 mm
55-7540	Angled	61 mm	8 3/4 in	222 mm
55-7550	Angled	86 mm	9 1/4 in	235 mm



55-7525

Clamps (Hemagrip)

"Fogarty Type" Hemagrip Clamp

CODE	ANGLE	JAW	LENGTH
55-7520	Straight	33 mm	6½ in 165 mm
55-7530	Straight	61 mm	11½ in 292 mm
55-7555	Straight	86 mm	10¼ in 260 mm



55-7520

Clamps (Hemostatic)

Gemini Forceps

Delicate Jaws

CODE	ANGLE	LENGTH
54-7255	Full Curve	5½ in 140 mm
54-7256	Full Curve	7¼ in 184 mm
54-7257	Full Curve	8¼ in 210 mm
54-7258	Full Curve	9 in 229 mm
54-7259	Full Curve	11¼ in 286 mm



54-7255

Gemini Classic® Delicate Clamp

CODE	DESCRIPTION	LENGTH
30-4492	80° Angle	7¼ in 184 mm



Clamps (Hemostatic)

Gemini Hemostatic Clamp

CODE	DESCRIPTION	LENGTH	
19-5580	Curved	7 in	178 mm
19-5581	Curved	8 in	203 mm
19-5582	Curved	9 in	229 mm
19-5583	Curved	10 in	254 mm



19-5580

Wylie "J" Clamp

CODE	JAWS (W X D)	LENGTH	
55-6072	33 x 25 mm	8 ½ in	216 mm
55-6272	Acutely Curved	9 ⅝ in	244 mm



55-6072

Clamps (Hinge)

Malis® Hinge Clamp

CODE	DESCRIPTION
50-1453	Hinge Clamp



Clamps (Hypogastric)

Wylie Hypogastric Clamp

Angled Shanks

CODE	DESCRIPTION	LENGTH	
55-6102	Curved Jaws	9 ½ in	241 mm



Clamps (Iliac)

Cooley Classic® Iliac Clamp

Angled Shaft, 2 x 2 Vascular Teeth

CODE	JAW LENGTH	LENGTH
37-1402	2 ³ / ₈ in 60 mm	8 ¹ / ₂ in 216 mm



Cooley Iliac Clamp

CODE	JAW LENGTH	LENGTH
37-1401	2 ³ / ₈ in 60 mm	10 in 254 mm



Opti-Length® Iliac Clamp

Angle, 2 x 2 Vascular Teeth

CODE	JAW LENGTH	LENGTH
67-7533	2 ³ / ₈ in 60 mm	12 in 305 mm



Clamps (Femoral Popliteal Anastomosis)

Dale Femoral Popliteal Anastomosis Clamp

CODE	DESCRIPTION	LENGTH
55-6098	DeBakey Jaws	7 ¹ / ₄ in 184 mm



Clamps (Instrument Kit)



Castaneda Instrument Kit

Width 7 in (178 mm), Depth 2 in (51 mm)

CODE	DESCRIPTION	LENGTH	
30-9025	Kit Includes the Following:	11 in	279 mm
30-9000	Multi-Purpose Clamp, Angled 30°		
30-9001	Multi-Purpose Clamp, Angled 50°		
30-9002	Partial Occlusion Clamp, Spoon Shape		
30-9003	Anastomosis Clamp, Small		
30-9004	Anastomosis Clamp, Medium		
30-9005	Anastomosis Clamp, Large, Castaneda Retractors	4 5/16 in	110 mm
50-8060	Sternal Retractor, Small		
50-8061	Sternal Retractor, Large		
30-8500	Vascular Forceps, Titanium, 2/Each	6 in	152 mm
19-8150	Mixer Clamp, Smooth Jaw	5 1/4 in	133 mm

Clamps (Intestinal)

Doyen Vascular Intestinal Clamp

2 x 3 Vascular Teeth

CODE	TEETH	JAW LENGTH		LENGTH	
37-1600	Straight	3 3/4 in	95 mm	9 in	229 mm
37-1601	Curved	3 3/4 in	95 mm	9 in	229 mm



37-1600

Clamps (Ligature Carrier)

Favaloro-Semb Ligature Carrier

CODE	DESCRIPTION	LENGTH
55-6040FC	Full Curved	11 in 279 mm



DeBakey-Semb Classic® Ligature Carrying Forceps

Length of Serrations $\frac{5}{8}$ in (16 mm), 1 x 2 Vascular Teeth

CODE	JAW LENGTH	LENGTH
37-1132	2¼ in 57 mm	10 in 254 mm



DeBakey-Semb Opti-Length® Ligature Carrying Forceps

CODE	DESCRIPTION	LENGTH
67-7534	Carrying Forceps	11 in 279 mm
67-7535	Carrying Forceps	12 in 305 mm



65-7534

Clamps (Liver)

Masters-Schwartz Liver Clamp

CODE	JAW WIDTH	LENGTH
19-4063	½ in 13 mm	7½ in 191 mm



Clamps (Micro-Coronary Bulldog)

Jacobson Micro-Coronary Bulldog Clamp

Adjustable Tension

CODE	ANGLE	JAW	LENGTH
55-4060	Straight	21 mm	1 7/8 in 48 mm



Clamps (Vascular)

Gregory Miniature Vascular Clamp

CODE	DESCRIPTION	LENGTH
55-5047	Straight	4 1/2 in 114 mm
55-5048	Curved	4 1/2 in 114 mm



55-5047

Clamps (Thoracic)

Modified Collier Clamp

CODE	DESCRIPTION	LENGTH
30-8065	Curved	10 1/2 in 267 mm



Henly Classic® Modified Vascular Clamp

1x2 Vascular Teeth

CODE	JAW LENGTH	LENGTH
37-1275	3/4 in 19 mm	7 1/2 in 191 mm



Clamps (Neonatal)

Cooley Neonatal Clamp

1 x 2 Vascular Teeth

CODE	DESCRIPTION	LENGTH	
55-5065	Straight	5 in	127 mm
55-5066	Angled Shanks, Straight Jaw	5 in	127 mm
55-5067	Curved Shanks, Straight Jaw	5 in	127 mm
55-6140	Spoon Jaw	5 in	127 mm



55-6140

Cooley Neonatal Antastomosis Clamp

CODE	DESCRIPTION	LENGTH	
55-6142	Satinsky	5 in	127 mm



55-6142

Cooley Neonatal Carotid Clamp

CODE	LENGTH	
55-6143	5 in	127 mm

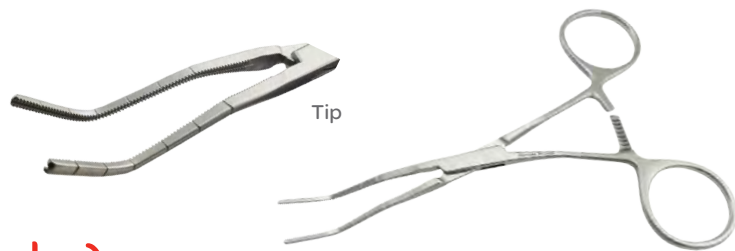

Clamps (Neonatal Vascular)

Neonatal Vascular Clamp

Calibrated Jaws 1.0 mm Wide, Horizontal Serrations

CODE	DESCRIPTION	LENGTH	
55-5040	Angled Jaws 30°	5 in	127 mm
55-5041	Angled Jaws 50°	5 in	127 mm
55-5042	Angled Jaws 90°	5 in	127 mm



55-5042

Clamps (Occluding)

Cooley Atraumatic Clamp

CODE	DESCRIPTION	LENGTH
55-3925	Clamp	4 ¾ in 121 mm



Cooley Occlusion Clamp

Right Angle Jaw

CODE	SIZE	JAW	LENGTH
55-5075	Small	17 mm	5 ½ in 140 mm
55-5077	Large	35 mm	6 ½ in 165 mm



55-5077

Cooley Occlusion Clamp

Jaws 36 mm Long

CODE	DESCRIPTION	LENGTH
55-6138	Curved	8 ¼ in 210 mm

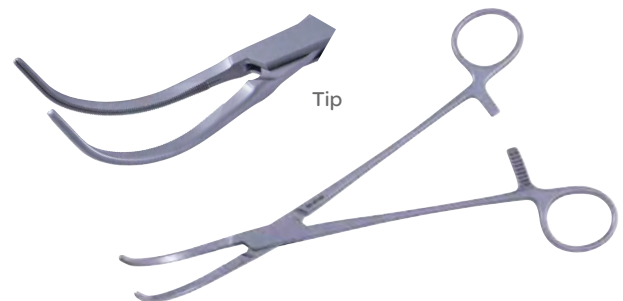

Clamps (Vascular)

Castaneda Partial Occlusion Clamp

Spoon Type

CODE	JAW LENGTH	JAW DEPTH	LENGTH
30-9002	1 ⁵ / ₁₆ in 33 mm	⁵ / ₁₆ in 8.0 mm	4 ³ / ₄ in 121 mm



Cooley Partial Occlusion Clamp

CODE	WIDTH	DEPTH	LENGTH
55-6135	7.0 mm	23 mm	7 ³ / ₄ in 197 mm
55-6136	8.0 mm	35 mm	8 ¹ / ₂ in 216 mm
55-6137	12 mm	52 mm	8 ¹ / ₂ in 216 mm
55-6155	12 mm	60 mm	8 ¹ / ₂ in 216 mm

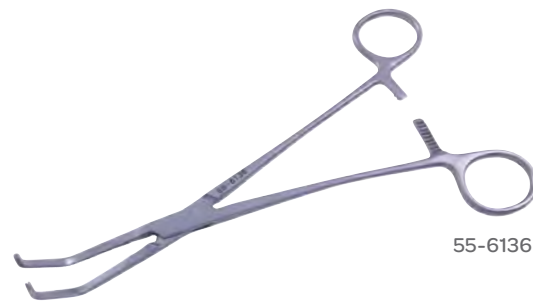

55-6136

Clamps (Patent Ductus)

Cooley Classic® Patent Ductus Clamp

2 x 2 Vascular Teeth

CODE	SHAFT	JAW LENGTH	LENGTH
37-1250	Straight Shaft	1 ³ / ₁₆ in 30 mm	6 ¹ / ₄ in 159 mm
37-1251	Angular Shaft	1 ³ / ₁₆ in 30 mm	6 ¹ / ₄ in 159 mm



37-1250

Clamps (Patent Ductus)

DeBakey Classic® Patent Ductus & Peripheral Vascular Clamp

1x2 Vascular Teeth

CODE	SHAFT	JAW LENGTH	LENGTH
37-1160	Straight Shaft	1 ³ / ₁₆ in 30 mm	7 ¹ / ₂ in 191 mm
37-1161	Angular Shaft	1 ³ / ₁₆ in 30 mm	7 ¹ / ₂ in 191 mm



37-1160

Cooley Patent Ductus Clamp

CODE	DESCRIPTION	JAW LENGTH	LENGTH
55-6132	Angled Shanks	30 mm	8 in 203 mm



Clamps (Pediatric)

Cooley Pediatric Clamp

CODE	DESCRIPTION	LENGTH
55-5002	Straight, Angled Jaw	5 ¹ / ₂ in 140 mm
55-5004	Straight, Spoon Jaw	5 ¹ / ₂ in 140 mm
55-5005	Angled, Straight Jaw	5 ¹ / ₂ in 140 mm



55-5002

DeBakey Pediatric Patent Ductus Clamp

CODE	DESCRIPTION	LENGTH
55-5051	Straight	6 ³ / ₄ in 171 mm
55-5052	Angled	6 ³ / ₄ in 171 mm
55-5053	Spoon Jaw	7 in 178 mm



55-5051

Clamps (Peripheral Blood Vessel)

Selman Peripheral Blood Vessel Clamp

CODE	DESCRIPTION	JAWS	LENGTH
55-6152	Straight	25 mm	5½ in 140 mm



Clamps (Peripheral Vascular)

DeBakey Classic® Peripheral Vascular Clamp

1 x 2 Vascular Teeth

CODE	DESCRIPTION	JAWS (L X D)	LENGTH
37-1110	Angled	2½ x 5/16 in	64 x 8.0 mm 7 in 178 mm
37-1125	Curved	1 5/8 x 5/16 in	41 x 8.0 mm 6½ in 165 mm
37-1115	S-Shaped	3 x 5/16 in	76 x 8.0 mm 8 in 203 mm



37-1110

Leland-Jones Classic® Peripheral Vascular Clamp

1 x 2 Vascular Teeth

CODE	ANGLE	JAW LENGTH	LENGTH
37-1080	15°	2 5/8 in 67 mm	7½ in 191 mm
37-1081	30°	2 5/8 in 67 mm	7½ in 191 mm



37-1080

Cooley Peripheral Vascular Clamp

CODE	JAWS	LENGTH
55-6580	Curved	6½ in 165 mm



55-6580

Clamps (Peripheral Vascular)

Cooley Peripheral Vascular Clamp

CODE	ANGLE	JAWS	LENGTH
55-6171	55°	35 mm	6½ in 165 mm
55-6172	55°	44 mm	6¾ in 171 mm
55-6174	55°	70 mm	7 in 178 mm
55-6173	55°	70 mm	7 in 178 mm

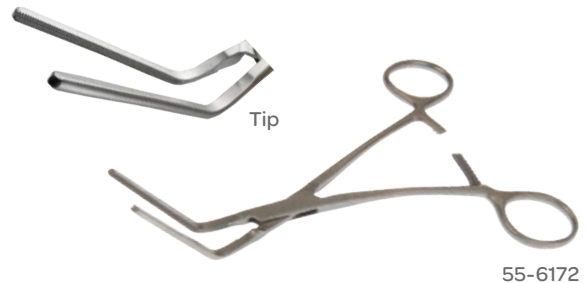

Leland-Jones Peripheral Vascular Clamp

Straight Shanks

CODE	DESCRIPTION	LENGTH
55-6025	Straight	7½ in 191 mm
55-6026	15° Angle	7½ in 191 mm
55-6027	30° Angle	7½ in 191 mm

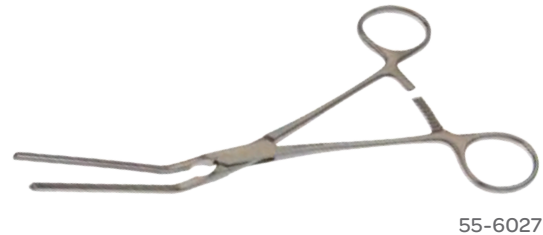

Selman-Cooley Peripheral Vascular Clamp

CODE	ANGLE	JAW	LENGTH
55-6170	Curved	15 x 8.5 mm	5 in 127 mm



Clamps (Profunda)

Gregory Profunda Clamp

CODE	DESCRIPTION	LENGTH
55-6090	Extra Small Jaws	4⅞ in 124 mm
55-6091	Medium Jaws	7¼ in 184 mm
55-6092	Large Jaws	7¾ in 197 mm



Clamps (Renal)

Cleveland Clinic Renal Clamp

CODE	DESCRIPTION	LENGTH	
55-3533	Small Jaw, Angled Left, Baby Clamp	5 ½ in	140 mm
55-3534	Small Jaw, Angled Right, Baby Clamp	6 ½ in	165 mm
55-3531	Large Jaw, Angled Left	9 ⅝ in	244 mm
55-3532	Large Jaw, Angled Right	9 ⅝ in	244 mm



Classic® Renal Artery Clamp

Blades Calibrated at 5.0 mm Intervals, Curved Shafts, 2 x 2 Vascular Teeth

CODE	JAW LENGTH		LENGTH	
37-1241	1 in	25 mm	7 ¼ in	195 mm



Cooley Renal Artery Clamp

CODE	LENGTH	
55-5057	7 ½ in	191 mm

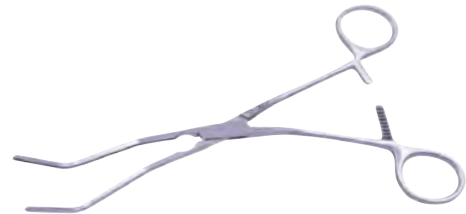

Renal Artery Clamp

2 x 2 Vascular Teeth

CODE	JAW LENGTH		LENGTH	
37-1242	1 in	25 mm	10 ⅝ in	270 mm



Clamps (Ring Handle Bulldog)

DeBakey Ring Handle Bulldog Clamp

CODE	DESCRIPTION	JAW	LENGTH
55-4022	Straight Shanks, 90° Jaw	40 mm	4 ¾ in 121 mm
55-4019	Straight Shanks, Straight Jaw	45 mm	5 ½ in 130 mm
55-4020	Straight Shanks, Curved Jaw	45 mm	5 in 127 mm
55-4021	"S" Curved	45 mm	5 in 127 mm
55-4023	Curved Shanks, 45° Jaw		4 ¾ in 121 mm



55-4023

Stoney Spleno-Reno Shunt Clamp

CODE	DESCRIPTION	LENGTH
55-6095	Small	8 ¼ in 210 mm
55-6096	Medium	9 in 249 mm
55-6097	Large	9 ⅝ in 244 mm

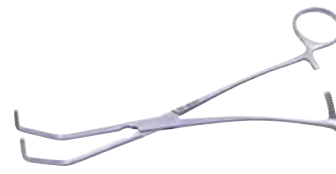

55-6097

Clamps (Spoon-Shaped)

Glover Classic® Spoon-Shaped Clamp

1 x 2 Vascular Teeth

CODE	DESCRIPTION	JAW (L X D)	LENGTH
37-1101	Extra Long	2 ⅜ x ⅝ in 60 x 7.0 mm	10 in 254 mm
37-1100	Standard	1 ¾ x ⅝ in 44 x 8.0 mm	8 ½ in 216 mm



37-1101

Clamps (Wire Holding)

Rubio Classic Plus® Wire Holding Clamp

CODE	DESCRIPTION	LENGTH
36-2023	Tungsten Carbide Jaw Inserts	5 in 127 mm



Clamps (Stay Suture)

Gregory Stay Suture Clamp

Gold Band

CODE	DESCRIPTION	LENGTH	
19-8027	Large #2, Smooth Jaws	$\frac{3}{4}$ in	19 mm
19-8029	Large #4	$1\frac{5}{8}$ in	41 mm



19-8027

Clamps (Supraceliac)

Cherry Supraceliac Clamp

Shanks Curved 60°

CODE	DESCRIPTION	LENGTH	
55-6117	Curved Jaws	$12\frac{1}{2}$ in	318 mm



Clamps (Tangential Occlusion)

DeBakey Classic® Tangential Occlusion Clamp

1 x 2 Vascular Teeth

CODE	JAW LENGTH		JAW DEPTH		LENGTH	
37-1192	$2\frac{3}{8}$ in	60 mm	$\frac{5}{8}$ in	16 mm	10 in	254 mm
37-1193	$2\frac{3}{8}$ in	60 mm	$\frac{5}{8}$ in	16 mm	$10\frac{1}{4}$ in	260 mm

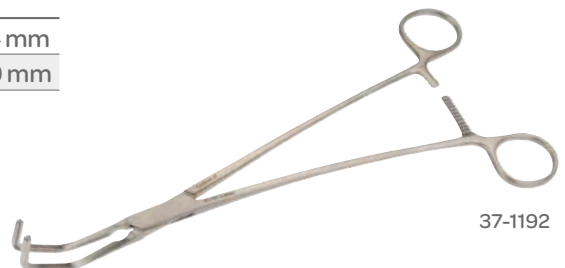

37-1192

Clamps (Tangential Occlusion)

Cooley Tangential Occlusion Clamp

Double Angled Jaws Calibrated at 5.0 mm Intervals

CODE	DEPTH	WIDTH	LENGTH
55-6570	6.0 mm	20 mm	7 ³ / ₄ in 197 mm
55-6572	7.0 mm	26 mm	8 ³ / ₄ in 222 mm
55-6574	10 mm	34 mm	9 ³ / ₄ in 248 mm

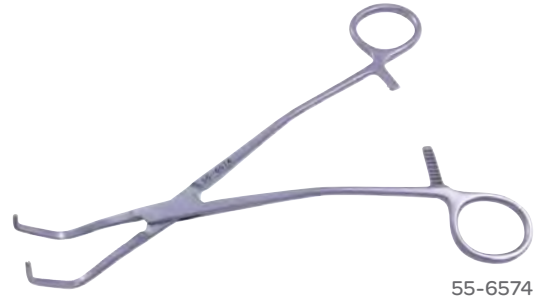

DeBakey Tangential Occlusion Clamp

CODE	LENGTH	DEPTH	LENGTH
55-6044	48 mm	16 mm	9 ³ / ₄ in 248 mm
55-6047	75 mm	17 mm	11 in 279 mm

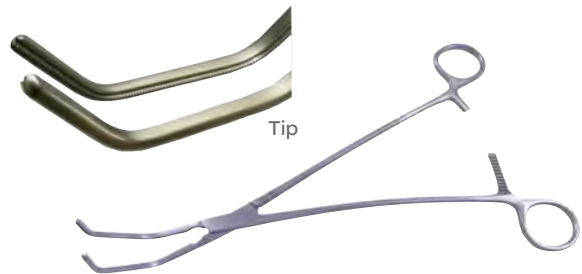

Clamps (Thoracic)

Castaneda-Mixer Thoracic Clamp

CODE	DESCRIPTION	LENGTH
19-8150	Smooth Jaws	5 ¹ / ₄ in 133 mm



Harrington-Mixer Thoracic Clamp

Longitudinal Serrations with Cross-Serrated Tips

CODE	DESCRIPTION	LENGTH
30-8051	Right Angled	12 ¹ / ₄ in 311 mm



Clamps (Thoracic)

Jones Thoracic Clamp

CODE	DESCRIPTION	LENGTH
19-8152	Curved	11¼ in 286 mm

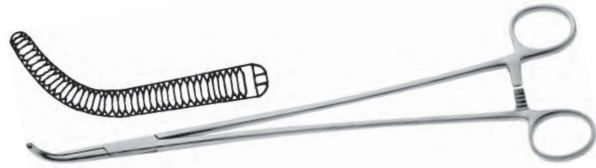

Mixer Thoracic Clamp

CODE	DESCRIPTION	LENGTH
19-8146	Angular, Soft Jaw, Cross-Serrated Tips	11 in 279 mm
19-8147	Angular, Standard Jaw	11 in 279 mm
19-8145	Curved, Cross-Serrations	9 in 229 mm



19-8145

DeBakey Thoracic Dissecting Forceps

CODE	DESCRIPTION	LENGTH
55-5070	"C" Curve	7½ in 191 mm
55-5072	"C" Curve	9 in 229 mm
55-5071	"D" Curve	7½ in 191 mm

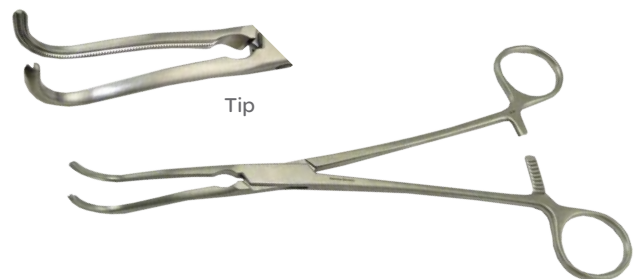

55-5070

Clamps (Tibial Artery)

Demos Tibial Artery Clamp

CODE	JAWS	LENGTH
55-6107	40 mm	8¼ in 210 mm

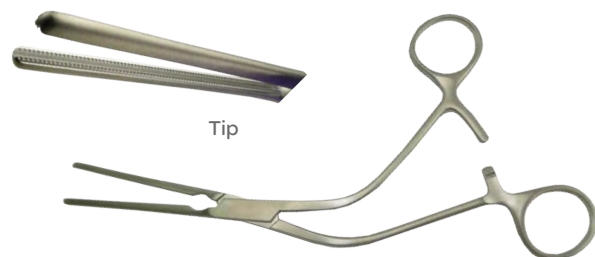

Clamps (Tubing)

Tube Clamp Forceps

Cross-Hatched Jaws, Tubing Jaw Opening with Closed Ratchets $\frac{1}{8}$ in (3.0 mm)

CODE	DESCRIPTION	JAW LENGTH		LENGTH	
32-3514	Clamp Forceps	1 in	25 mm	6 $\frac{1}{2}$ in	165 mm



Tubing Clamp

Should Be Used with Tubing No Larger Than $\frac{1}{4}$ in (6.0 mm) Diameter

CODE	DESCRIPTION	JAW LENGTH		LENGTH	
19-8010		1 $\frac{5}{16}$ in	33 mm	7 $\frac{1}{2}$ in	191 mm
32-3514	With Guard, Tubing 22 mm			8 in	203 mm



19-8010

Clamps (Vascular)

Beck-Cooley Vascular Clamp

Jaws Calibrated at 5.0 mm Intervals, Cooley Jaws

CODE	DESCRIPTION	LENGTH	
55-5037	Medium Curve	6 in	152 mm



Clamps (Vascular)

Cooley Classic® Vascular Clamp

Blades Calibrated at 5.0 mm Intervals, 2 x 2 Vascular Teeth

CODE	ANGLE	JAWS (L X D)	LENGTH
37-1282	60°	1 x $\frac{5}{16}$ in 25 x 8.0 mm	6 $\frac{3}{4}$ in 171 mm
37-1280	90°	1 x $\frac{5}{16}$ in 25 x 8.0 mm	6 $\frac{1}{2}$ in 165 mm



37-1280

Cooley Vascular Clamp

Angled Shanks, Blades Calibrated at 5.0 mm Intervals

CODE	DESCRIPTION	LENGTH
55-5030	60°	6 $\frac{1}{2}$ in 165 mm
55-5027T	90°, Titanium	6 in 152 mm
55-5028	90°	6 $\frac{1}{2}$ in 165 mm



55-5028

DeBakey Opti-Length® Vascular Clamp

CODE	DESCRIPTION	LENGTH
67-7523	Vascular Clamp	9 in 229 mm
67-7524	Vascular Clamp	10 in 254 mm



67-7523

DeBakey Vascular Clamp

1 x 2 Vascular Teeth

CODE	DESCRIPTION	JAW	LENGTH
37-1130	Acutely Curved	2 x $\frac{3}{8}$ in 51 x 10 mm	9 $\frac{1}{2}$ in 241 mm



Clamps (Vascular)

Reynolds Classic® Vascular Clamp

1 x 2 Vascular Teeth

CODE	SIZE	JAW (L X D)		LENGTH	
37-1323	50° Angle	1 x $\frac{3}{16}$ in	25 x 5.0 mm	7 in	178 mm
37-1324	50° Angle	1 $\frac{3}{16}$ x $\frac{3}{16}$ in	30 x 5.0 mm	7 in	178 mm
37-1326	85° Angle	1 $\frac{3}{16}$ x $\frac{3}{16}$ in	30 x 5.0 mm	6 $\frac{1}{2}$ in	165 mm

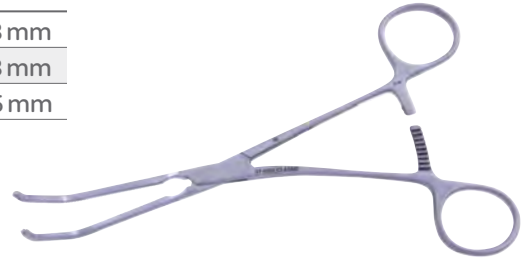

37-1323

Reynolds Vascular Clamp

CODE	DESCRIPTION	JAWS	LENGTH
55-5033	DeBakey Teeth	85° Small	6 $\frac{3}{4}$ in 171 mm

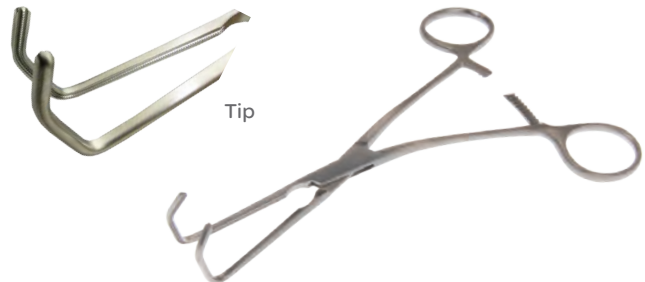

Clamps (Vena Cava)

Satinsky Classic® Vena Cava Clamp

1 x 2 Vascular Teeth

CODE	SIZE	JAW (L X D)		LENGTH	
37-1202	Small	2 $\frac{1}{4}$ x $\frac{1}{4}$ in	57 x 6.0 mm	9 $\frac{1}{2}$ in	241 mm
37-1201	Medium	2 $\frac{1}{2}$ x $\frac{3}{8}$ in	64 x 10 mm	9 $\frac{1}{2}$ in	241 mm
37-1200	Large	2 $\frac{3}{4}$ x $\frac{1}{2}$ in	70 x 13 mm	9 $\frac{1}{2}$ in	241 mm

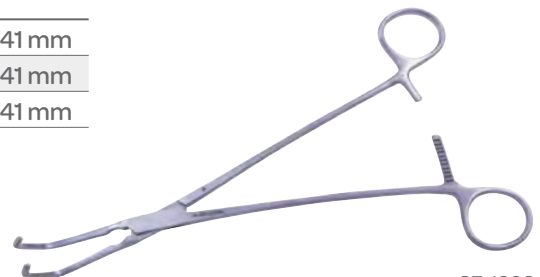

37-1202

Clamps (Vena Cava)

Satinsky Vena Cava Clamp

CODE	TEETH	JAWS (L X D)	LENGTH
55-6050	DeBakey Teeth	4.0 x 9.0 mm	10 in 254 mm



Clamps

Castaneda Clamp

CODE	DESCRIPTION	LENGTH
55-5841T	30° Angle, Titanium	4 ¼ in 108 mm
55-5842T	70° Angle, Titanium	4 ¼ in 108 mm
55-5843T	90° Angle, Titanium	4 ¼ in 108 mm
55-5085	Horizontal Serrations, Long Thin Calibrated, Spoon Jaw	5 in 127 mm



55-5841T

Castaneda Multi Purpose Clamp

CODE	ANGLE	JAW LENGTH	LENGTH
30-9000	30°	1 ¾ in 35 mm	5 in 127 mm
30-9001	50°	1 ¾ in 35 mm	5 in 127 mm
30-9006	90°	1 ¾ in 35 mm	5 in 127 mm

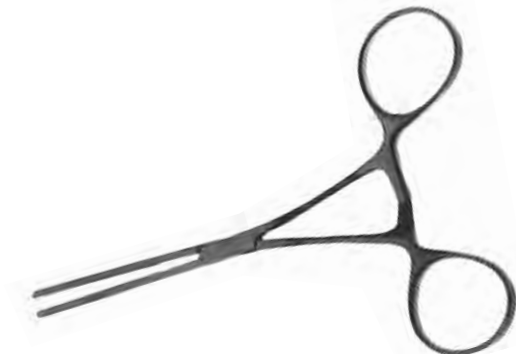

30-9000

Clamps

Cooley Miniature Multi-Purpose Clamp

Jaws Calibrated at 5.0 mm Intervals

CODE	DESCRIPTION	LENGTH
55-5019	30° Angle	6½ in 165 mm
55-5018	60° Angle	6 in 152 mm
55-5017	90° Angle	5½ in 140 mm



55-5019

Cooley Multi Purpose Clamp

CODE	ANGLE	JAW LENGTH	LENGTH
37-1290	30°, 2x2 Vascular Teeth, Calibrated Jaws	1⅜ in 30 mm	6½ in 165 mm
37-1291	60°, 2x2 Vascular Teeth, Calibrated Jaws	1⅜ in 30 mm	6 in 152 mm
37-1292	90°, 2x2 Vascular Teeth, Calibrated Jaws	1⅜ in 30 mm	5½ in 140 mm
55-6161	Angled 60°	2⅛ in 54 mm	9 in 229 mm
55-6162	Angled 60°	2¾ in 70 mm	9½ in 241 mm



37-1291

Crile-Type Clamp

CODE	DESCRIPTION	JAW	LENGTH
37-4037	Serrated Curved	1½ in 38 mm	7½ in 191 mm



Clamps (Multi-Purpose)



37-1321

DeBakey Multi Purpose Clamp

CODE	ANGLE	TEETH	JAW LENGTH		LENGTH	
37-1321	60°	1 x 2 Vascular Teeth	1 ³ / ₈ in	35 mm	6 in	152 mm
55-6038	60°	1 x 2 DeBakey Teeth	1 ¹ / ₂ in	38 mm	9 ¹ / ₄ in	235 mm
37-1171	60°	1 x 2 Vascular Teeth	2 in	51 mm	8 in	203 mm
37-1172	60°	1 x 2 Vascular Teeth	2 ³ / ₄ in	70 mm	9 ¹ / ₂ in	241 mm
55-6042	60°	1 x 2 DeBakey Teeth	4 in	102 mm	12 in	305 mm
37-1183	90°	1 x 2 Vascular Teeth	4 in	102 mm	10 ¹ / ₂ in	267 mm
55-6035	90°	1 x 2 DeBakey Teeth	2 in	51 mm	8 in	203 mm
55-6036	90°	1 x 2 DeBakey Teeth	3 in	76 mm	8 ¹ / ₂ in	216 mm
55-6034	90°	1 x 2 DeBakey Teeth	1 ¹ / ₂ in	38 mm	8 ³ / ₄ in	222 mm

DeBakey Castaneda Clamp

Long Serrated with Cross Serrated Tips

CODE	DESCRIPTION	LENGTH
55-4926	Anastomosis Jaws. #1	4 ¹ / ₄ in 108 mm
55-4929	Carotid Jaws	4 ¹ / ₄ in 108 mm
55-4932	"S" Curved	4 ¹ / ₄ in 108 mm



55-4929

DeBakey Multi-Purpose Peripheral Vascular Clamp

CODE	JAWS	LENGTH
55-6022	65 mm	7 in 178 mm



Clamps

DeBakey-Cooley Clamp

Long Serrated with Cross Serrated Tips

CODE	DESCRIPTION	LENGTH	
55-6189	Slightly Curved Jaws	10 in	254 mm



37-1096



55-6077

Glover Clamp

CODE	DESCRIPTION	JAW (L X D)		LENGTH	
55-6077	Curved Right Angle, Long, DeBakey Teeth			8 in	203 mm
37-1096	Extra Long, Curved, 1 x 2 Vascular Teeth	2½ x ¾ in	64 x 10 mm	9½ in	241 mm
37-1097	Right Angle, Curved, 1 x 2 Vascular Teeth	1¾ x 1¾ in	44 x 44 mm	7⅛ in	181 mm
37-1095	Standard, Curved, 1 x 2 Vascular Teeth	2 x ¾ in	51 x 10 mm	8⅛ in	206 mm

Harken Auricle Clamp

CODE	DESCRIPTION	LENGTH	
55-5107	#1 Curve, Cross-Serrated Jaws	9¼ in	235 mm
55-6069	#2 Curve, DeBakey Teeth	10 in	254 mm
55-5108	#2 Curve, Cross-Serrated Jaws	9¼ in	235 mm
55-6071	#4 Curve, DeBakey Teeth	10 in	254 mm



55-6071

Hendren Clamp

Jaws Calibrated at 5.0 mm Intervals, Very Delicate Cooley Teeth

CODE	DESCRIPTION	LENGTH	
55-6540	6.0 mm Jaw Base	8¼ in	210 mm
55-6546	24 mm Jaw Base	8¼ in	210 mm



55-6546

Clamps

Pennington Clamp

CODE	JAWS	TIP WIDTH	LENGTH
19-4000	Triangular Jaws	$\frac{7}{16}$ in 11 mm	6 in 152 mm
19-4001	Triangular Jaws	$\frac{7}{16}$ in 11 mm	8 in 203 mm



19-4001

Vanderbilt Clamp

CODE	DESCRIPTION	LENGTH
54-5001	Curved, Horizontal Serrations	8 $\frac{5}{8}$ in 219 mm



Containers

Bookwalter® I.M.A. Retractor Case

CODE	DESCRIPTION
50-4604	Storage



Bookwalter® Table Fixation & Ring Case

CODE	DESCRIPTION	LENGTH
50-4507	Table Fixation and Ring Case	2 3/4 in x 13 1/8 in x 22 1/8 in 95 x 333 x 562 mm



Cardiac Retractor Case

CODE	DESCRIPTION
87-0628	Retractor Case



Containers

Castaneda Instrument Case

CODE	WIDTH X DEPTH	LENGTH
21-8010	7x2in 178x51mm	11in 279mm



Diethrich Instrument Case

CODE	WIDTH X DEPTH	LENGTH
21-8000	6 ³ / ₄ x2in 171x51mm	10 ¹ / ₂ in 267mm



Dilator Case

CODE	DESCRIPTION	LENGTH
21-8005	Stainless Steel	9in 229mm



Containers

I.M.A. Instrument Case

CODE	DESCRIPTION
80-1865	Two Level Storage

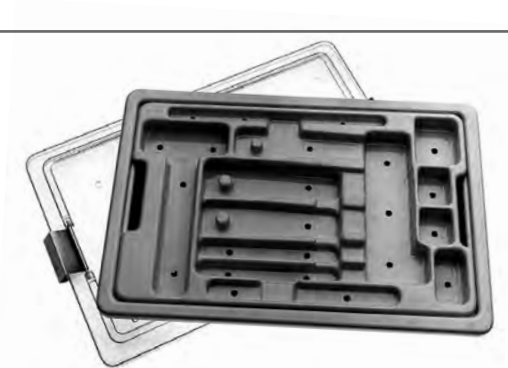

Instrument Case for Anterior Cervical Fusion Instruments

CODE	DESCRIPTION	LENGTH
21-1001	Instrument Case	9 in 229 mm



Microcare® Bayonet Case

Removable Lid

CODE	DESCRIPTION	LENGTH
80-1565	Large	15 in 381 mm
80-1564	Small	10 ½ in 267 mm



80-1565

Containers

Microcare® Case

CODE	DESCRIPTION	LENGTH	
80-1598	Small	11 in	279 mm
80-1599	Large	21 in	533 mm
80-1597	Medium	15½ in	394 mm



80-1597

Microcare® Combo Instrument Case

CODE	DESCRIPTION	LENGTH	
80-1567	Instrument Case	15 in	381 mm



Microcare® Flex Mat

CODE	DESCRIPTION	LENGTH	
80-1830	10 x 18 in 254 x 458 mm	18 in	458 mm

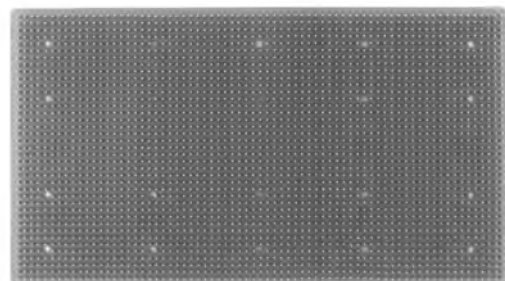

Containers

Microcare® Instrument Case

CODE	DESCRIPTION	LENGTH
80-1563	Small	10 ½ in 267 mm
80-1562	Large	15 in 381 mm



Micropak Classic Series II

CODE	DESCRIPTION
0217	Base, Lid, Insert Tray and Mat



80-1563

Noon A-V Fistula Case

CODE	WIDTH X DEPTH	LENGTH
21-8015	9 ¾ x 2 in 248 x 51 mm	12 in 305 mm



Containers

Sterilizing Tray

Depth 3 in

CODE	DESCRIPTION	LENGTH
21-3000	Small	11¼ in 286 mm
21-3001	Medium	16 in 406 mm
21-3002	Large, Depth 3 in (76 mm)	21¾ in 552 mm



21-3000

Open End Instrument Stringers

Instrument Stringer, Open End, Special Sizes Available Upon Request

CODE	WIDTH	LENGTH
52-0006	2½ in 64 mm	6 in 152 mm
52-0006-3	3 in 76 mm	6 in 152 mm
52-0006-4	4 in 102 mm	6 in 152 mm
52-0006-6	6 in 152 mm	6 in 152 mm
52-0007	2½ in 64 mm	7 in 178 mm
52-0007-3	3 in 76 mm	7 in 178 mm
52-0008	2½ in 64 mm	8 in 203 mm
52-0008-3	3 in 76 mm	8 in 203 mm
52-0008-4	4 in 102 mm	8 in 203 mm
52-0008-5	5 in 127 mm	8 in 203 mm
52-0010	2½ in 64 mm	10 in 254 mm
52-0010-4	4 in 102 mm	10 in 254 mm
52-0010-5	5 in 127 mm	10 in 254 mm
52-0010-6	6 in 152 mm	10 in 254 mm
52-0012	2½ in 64 mm	12 in 305 mm
52-0012-3	3 in 76 mm	12 in 305 mm
52-0012-4	4 in 102 mm	12 in 305 mm
52-0012-6	6 in 152 mm	12 in 305 mm
52-0014	2½ in 64 mm	14 in 356 mm
52-0014-4	4 in 102 mm	14 in 356 mm
52-0014-6	6 in 152 mm	14 in 356 mm
52-0016	2½ in 64 mm	16 in 406 mm
52-0016-5	5 in 127 mm	16 in 406 mm
52-0018	2½ in 64 mm	18 in 458 mm
52-0018-3	3 in 76 mm	18 in 458 mm
52-0018-4	4 in 102 mm	18 in 458 mm



52-0008

Containers

CVT

Weinstein Instrument Stringers

CODE	LENGTH	
51-0006W	6 in	152 mm
51-0008W	8 in	203 mm
51-0010W	10 in	254 mm
51-0012W	12 in	305 mm
51-0014W	14 in	356 mm



51-0006W

Instrument Stringers with Round Bar

CODE	DESCRIPTION	LENGTH	
51-0006	Stringers with Round Bar	6 in	152 mm
51-0008	Stringers with Round Bar	8 in	203 mm
51-0010	Stringers with Round Bar	10 in	254 mm
51-0012	Stringers with Round Bar	12 in	305 mm
51-0014	Stringers with Round Bar	14 in	356 mm
51-0016	Stringers with Round Bar	16 in	406 mm



51-0006

Instrument Stringer with Ball Closure

CODE	DESCRIPTION	LENGTH	
51-0006B	Stringer with Ball Closure	6 in	152 mm
51-0008B	Stringer with Ball Closure	8 in	203 mm
51-0010B	Stringer with Ball Closure	10 in	254 mm
51-0012B	Stringer with Ball Closure	12 in	305 mm



51-0006B

Mayo Bunt Instrument Holder

CODE	DESCRIPTION	LENGTH	
46-2810	Instrument Holder	5½ in	140 mm



Containers

Saunders Instrument Holder

CODE	DESCRIPTION
46-1780	Instrument Holder

*instrument not included



Instrument Stringer with Middle Lock

CODE	WIDTH	LENGTH
50-0006	2½ in 64 mm	6 in 152 mm
50-0008	2½ in 64 mm	8 in 203 mm
50-0010	2½ in 64 mm	10 in 254 mm
50-0012	2½ in 64 mm	12 in 305 mm
50-0014	2½ in 64 mm	14 in 356 mm
50-0016	2½ in 64 mm	16 in 406 mm
50-0018	2½ in 64 mm	18 in 458 mm

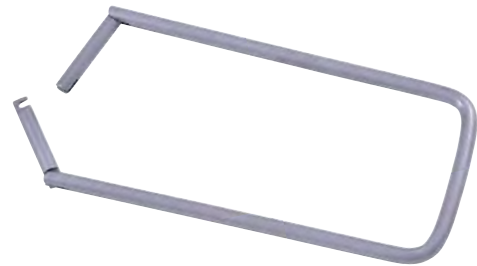

50-0006

Wire Instrument Rack

CODE	HEIGHT	LENGTH
21-4002	3¼ in 83 mm	4¼ in 108 mm



Wire Mesh Bur Holder

CODE	DESCRIPTION	LENGTH
79-0003	Small	1⅜ in 35 mm
79-0004	Large	2⅛ in 54 mm



79-0004

Containers

Clamp Box

Perforated with Sliding Lide

CODE	DESCRIPTION	
46-3746	2 x 1 x $\frac{3}{16}$ in	51 x 25 x 5.0 mm
46-3747	2 $\frac{1}{2}$ x 1 $\frac{5}{8}$ x $\frac{1}{4}$ in	64 x 41 x 6.0 mm
46-3748	3 x 1 x $\frac{3}{16}$ in	76 x 25 x 5.0 mm



46-3746

Cords

Air Hose

For use with 26-7006, 26-5000 and 26-5001.

CODE	DESCRIPTION	LENGTH
26-5007	Air Hose	10 ft 3 m



Cups

Iodine Cup

CODE	DESCRIPTION	LENGTH
32-3311	6 oz 177ml	3 x 2 in 76 x 51 mm



Cups

Medicine Cup

CODE	DESCRIPTION	LENGTH
32-3310	2 oz 59 ml	2 x 2 in 51 x 51 mm



Dilators (Myocardial)

Myocardial Dilator

CODE	DESCRIPTION	TIP WIDTH	LENGTH
25-8009	Graduated to 17.5 mm	2.0 mm	5 3/4 in 146 mm



25-8019

Dilators (Vascular)

Garrett Dilator

Malleable Shaft

CODE	DESCRIPTION	LENGTH
25-8015	Complete Set of All Sizes	
25-8016	1.0 mm	8 1/4 in 210 mm
25-8017	1.5 mm	8 1/4 in 210 mm
25-8018	2.0 mm	8 1/4 in 210 mm
25-8019	2.5 mm	8 1/4 in 210 mm
25-8020	3.0 mm	8 1/4 in 210 mm
25-8021	3.5 mm	8 1/4 in 210 mm
25-8022	4.0 mm	8 1/4 in 210 mm
25-8023	4.5 mm	8 1/4 in 210 mm
25-8024	5.0 mm	8 1/4 in 210 mm

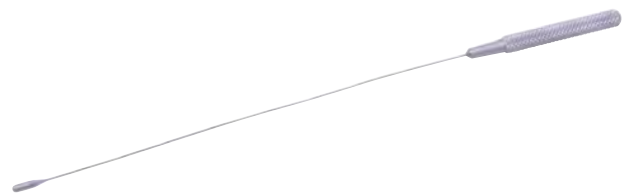

Dilators (Vascular)

Garrett Dilator Set

CODE	DESCRIPTION
55-7060	Dilator Set



DeBakey Vascular Dilator

Malleable Shaft

CODE	TIP SIZE	LENGTH
55-7200	Complete Set of All Sizes (includes the following)	
55-7205	0.5 mm	7½ in 191 mm
55-7015	2.0 mm	8¼ in 210 mm
55-7225	2.5 mm	7½ in 191 mm
55-7230	3.0 mm	7½ in 191 mm
55-7235	3.5 mm	7½ in 191 mm
55-7240	4.0 mm	7½ in 191 mm
55-7019	4.0 mm	8¼ in 210 mm
55-7245	4.5 mm	7½ in 191 mm
55-7020	4.5 mm	8¼ in 210 mm
55-7250	5.0 mm	7½ in 191 mm
55-7270	7.0 mm	7½ in 191 mm
55-7290	9.0 mm	7½ in 191 mm

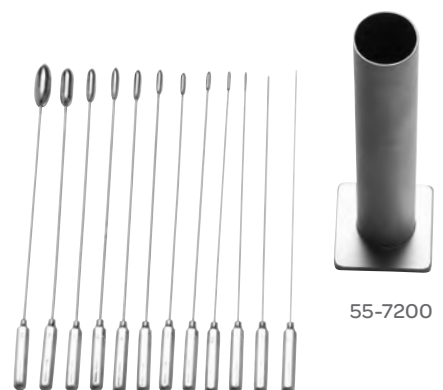

Dilators (Vascular)



Garrett Vascular Dilator

Malleable Shaft

25-8035

CODE	TIP SIZE	LENGTH
25-8035	Set of nine in 21-8005 case	
25-8036	1.0 mm	5½ in 140 mm
25-8037	1.0 mm	5½ in 140 mm
25-8038	2.0 mm	5½ in 140 mm
25-8039	2.0 mm	5½ in 140 mm
25-8040	3.0 mm	5½ in 140 mm
25-8041	3.5 mm	5½ in 140 mm
25-8042	4.0 mm	5½ in 140 mm
25-8043	4.5 mm	5½ in 140 mm
25-8044	5.0 mm	5½ in 140 mm



67-7390

67-7391

67-7392

67-7393

Vascular Dilator

Malleable Shaft

CODE	TIP SIZE	LENGTH
67-7390	1.0 mm	9½ in 241 mm
67-7391	1.5 mm	9½ in 241 mm
67-7392	2.0 mm	9½ in 241 mm
67-7393	2.5 mm	9½ in 241 mm
67-7394	3.0 mm	9½ in 241 mm
67-7395	3.5 mm	9½ in 241 mm
67-7396	4.0 mm	9½ in 241 mm
67-7397	4.5 mm	9½ in 241 mm
67-7398	5.0 mm	9½ in 241 mm

Dilators (Vascular)



Garrett Vascular Dilator

Malleable Shaft

CODE	TIP SIZE	LENGTH
55-7002	Set of nine sizes with holder	
55-7003	1.0 mm	5½ in 140 mm
55-7004	1.5 mm	5½ in 140 mm
55-7005	2.0 mm	5½ in 140 mm
55-7006	2.5 mm	5½ in 140 mm
55-7007	3.0 mm	5½ in 140 mm
55-7008	3.5 mm	5½ in 140 mm
55-7009	4.0 mm	5½ in 140 mm
55-7010	4.5 mm	5½ in 140 mm
55-7011	5.0 mm	5½ in 140 mm

Dilators (Vascular Dilator)



Garrett Vascular Dilator

Malleable Shaft

CODE	TIP SIZE	LENGTH
55-7012	Set of nine sizes with holder	
55-7013	1.0 mm	8¼ in 210 mm
55-7014	1.5 mm	8¼ in 210 mm
55-7015	2.0 mm	8¼ in 210 mm
55-7016	2.5 mm	8¼ in 210 mm
55-7017	3.0 mm	8¼ in 210 mm
55-7018	3.5 mm	8¼ in 210 mm
55-7019	4.0 mm	8¼ in 210 mm
55-7020	4.5 mm	8¼ in 210 mm
55-7020	5.0 mm	8¼ in 210 mm

Dilators (Vascular Dilator)

DeBakey Vascular Dilator

CODE	TIP SIZE	LENGTH
55-7210	1.0 mm	7½ in 191 mm
55-7215	1.5 mm	7½ in 191 mm
55-7220	2.0 mm	7½ in 191 mm

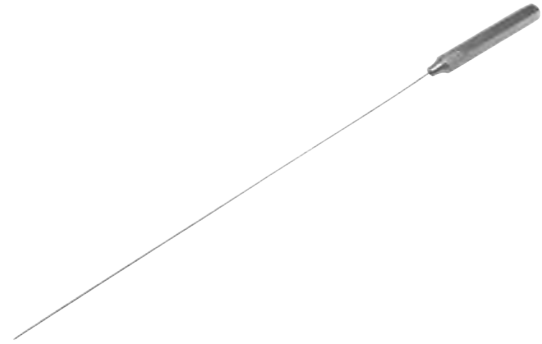

Cooley Coronary Dilator

Aluminum, Malleable Shaft, 5 in (127 mm)

CODE	DESCRIPTION
55-7001	Complete Set of Six Sizes
55-7105	0.5 mm Shaft
55-7110	1.0 mm Shaft
55-7115	1.5 mm Shaft
55-7120	2.0 mm Shaft
55-7125	2.5 mm Shaft
55-7130	3.0 mm Shaft



55-7125

Dissectors



63-8011

Lemmon Intima Dissector

CODE	DESCRIPTION	LENGTH
55-7042	Full Curve	6¾ in 162 mm
55-7041	Medium Curve	6¾ in 162 mm
63-8011	Slight Curve, Tip Width 4.0 mm	6½ in 165 mm
65-2405	Slightly Curved Dissector, Light Length	8¼ in 210 mm

Dissectors

MagnaFree® Penfield Dissector

Titanium



CODE	DESCRIPTION	LENGTH	65-2405
65-2402	Broad Curved Dissector and Sharp Round Spoon, Double-Ended	7 in	178 mm
65-2403	Slightly Curved Dissector and Wax Packer, Double-Ended	7¾ in	197 mm
65-2404	Fully Curved Dissector and Wax Packer, Double-Ended	7¾ in	197 mm
65-2405	Slightly Curved Dissector, Light Length	8¼ in	210 mm

Milligan Dissector

Double-Ended



CODE	TIP SIZE	LENGTH
65-1038	14 mm and 16 mm	8½ in 216 mm

Penfield Dissector



65-1015

CODE	DESCRIPTION	LENGTH
65-1015	Broad Curved Dissector and Sharp Round Spoon, Double-Ended	7 in 178 mm
65-1016	Slightly Curved Dissector and Wax Packer, Double-Ended	7¾ in 197 mm
65-1017	Full Curved Dissector and Wax Packer, Double-Ended	7¾ in 197 mm
65-1018	Slightly Curved Dissector, Light	8¼ in 210 mm
65-1019	Slightly Curved Blunt Dissector, Double-Ended	11½ in 272 mm

Dissectors

Smithwick Neck Hook-Dissector

Double-Ended-Blunt



CODE	HOOK LENGTH	TIP DIAMETER	LENGTH
38-1088	$\frac{7}{16}$ in 11 mm	0.2 mm	12 in 305 mm

Elevators

Cushing Elevator

Slightly Curved, Rounded Edge, Sharp

CODE	DESCRIPTION	LENGTH
26-6201	15 mm Wide	$7\frac{1}{8}$ in 181 mm

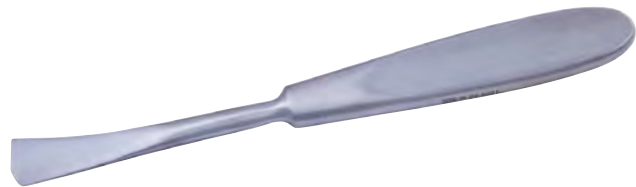

Elevators (Periosteal)

Freer Periosteal Elevator

One End Sharp and One End Blunt, Double-Ended

CODE	TIP	LENGTH
55-7026	6.5 mm	$7\frac{1}{2}$ in 181 mm
55-7027	4.5 mm	$7\frac{1}{2}$ in 181 mm



55-7026

Forceps (Alligator)

Hoehn Alligator Forceps

1x2

CODE	TIP WIDTH	LENGTH
30-1230	2.2 mm	5½ in 140 mm



Forceps (Artery)

Artery Forceps

CODE	DESCRIPTION	LENGTH
32-3548	Serrated, Curved	14 in 356 mm



Heiss Artery Forceps

CODE	DESCRIPTION	LENGTH
30-8016	Curved	7¼ in 184 mm



Forceps (Artery)

Nissen Artery Forceps

CODE	DESCRIPTION	LENGTH
16-4025	Curved	7¼ in 184 mm



Sarot Artery Forceps

Slightly Curved

CODE	JAW LENGTH	LENGTH
30-8059	2¼ in 57 mm	9 in 229 mm



Adson Artery Forceps

CODE	JAW LENGTH	LENGTH
16-4019	Straight, Standard Pattern	7⅞ in 181 mm
16-4021	Straight, Standard Pattern	8¼ in 210 mm
16-4118	Curved, Delicate Pattern	7⅞ in 181 mm
16-4119	Curved, Standard Pattern	7¼ in 184 mm
16-4121	Curved, Standard Pattern	8¼ in 210 mm



16-4019

Forceps (Artery)

Carmalt Artery Forceps

Jaws with Longitudinal Serrations and Cross-Serrated Tips

CODE	DESCRIPTION	LENGTH
16-3616	Straight	6 ½ in 165 mm
16-3716	Curved	8 7/8 in 225 mm
16-3720	Curved	9 in 229 mm
16-3723	Curved	6 ½ in 165 mm



16-3616

Coller-Crile Artery Forceps

CODE	DESCRIPTION	LENGTH
15-7384	Curved	5 ½ in 140 mm



Crafoord Coller Artery Forceps

CODE	DESCRIPTION	LENGTH
16-1524	Curved, Delicate Pattern	9 in 229 mm



Forceps (Artery)

Crile Artery Forceps

CODE	DESCRIPTION	LENGTH
15-7316	Curved	6¼ in 159 mm



Harrington Artery Forceps

CODE	DESCRIPTION	LENGTH
16-3727	Curved	10¾ in 273 mm

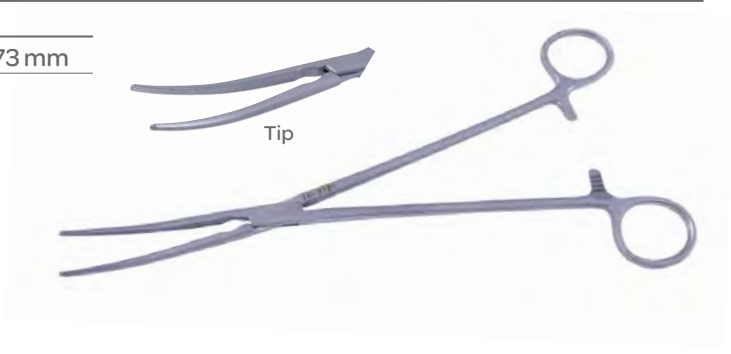

Heiss Artery Forceps

Delicate Pattern

CODE	DESCRIPTION	LENGTH
16-5024	Straight	9½ in 241 mm
16-5124	Curved	9¼ in 235 mm
16-5190	90°, Right Angle	8 in 203 mm
16-5194	90°, Right Angle	9½ in 241 mm



16-5190

Phaneuf Artery Forceps

CODE	DESCRIPTION	LENGTH
16-8021	Straight, 1 x 2 Teeth	8½ in 216 mm



Forceps (Artery)

Rochester-Mixer Artery Forceps

CODE	JAWS	LENGTH
17-0736	Angled 80°	6 ¼ in 159 mm
17-0740	Angled 80°	8 in 203 mm



17-0736

Sarot Artery Forceps

CODE	DESCRIPTION	LENGTH
54-5002	Horizontal Serrations	9 ½ in 241 mm
54-4900	Horizontal Serrations	11 in 279 mm
54-4905	Horizontal Serrations	13 in 330 mm



54-5002

Wikstroem Artery Forceps

CODE	DESCRIPTION	LENGTH
17-0770	Right Angled	8 ¼ in 210 mm



Forceps (Bariatric)

Bariatric Forceps

CODE	DESCRIPTION	LENGTH
32-3551	Right Angled	12 ¼ in 311 mm
32-3552	Right Angled	14 in 355 mm



32-3551

Rochester-Ochsner Bariatric Forceps

1 x 2 Teeth, Serrated

CODE	DESCRIPTION	LENGTH
32-3539	Straight	14 in 356 mm



Forceps (Clip Applier)

Spring Clip Applier

CODE	DESCRIPTION	LENGTH
37-4016	Used with Edward Parallel Jaw Spring Clips (Sold Separately)	7 ¼ in 184 mm

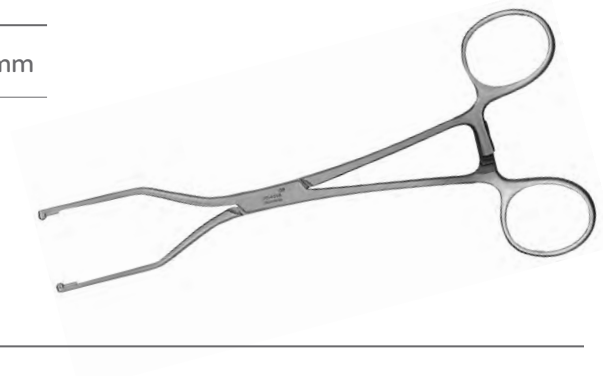

Forceps (Coarctation)

Crafoord Coarctation Forceps

CODE	DESCRIPTION	LENGTH
54-4709	Curved Jaw	9 ½ in 241 mm



Forceps (Cooley Caval Occlusion)

Cooley Caval Occlusion Forceps

CODE	DESCRIPTION	LENGTH
55-7034	36 French	8 ¼ in 210 mm
55-7035	40 French	8 ¼ in 210 mm



55-7035

Forceps (Coronary)

Reul Coronary Forceps

Fine Serrations, Tungsten Carbide Inserts

CODE	TIP WIDTH	LENGTH
30-8014	1.8 mm	7 ¾ in 197 mm



Forceps (Deep Surgical)

Bridge Deep Surgical Forceps

CODE	DESCRIPTION	LENGTH
30-4700	Curved	11 in 279 mm

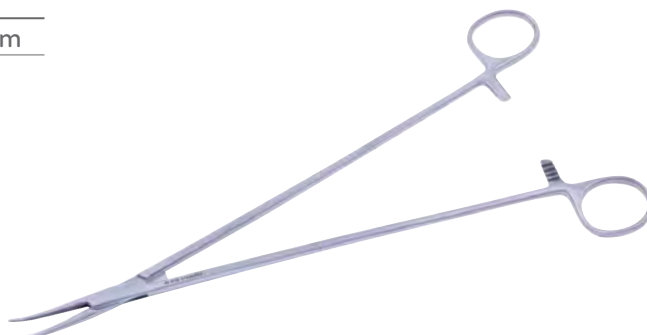

Forceps (Dissecting)

Meeker Deep Surgery Forceps

CODE	DESCRIPTION	LENGTH
30-4701	Right Angle	10 ³ / ₄ in 273 mm

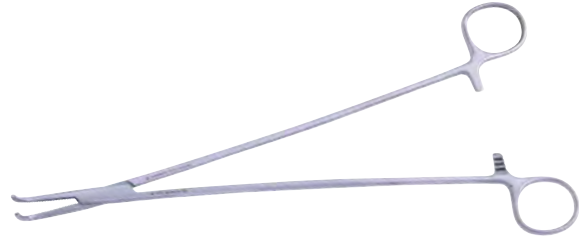

Thoracoscopy Meeker Dissecting Forceps

CODE	ANGLE	DIAMETER	LENGTH
54-0008	90° Curved	10 mm	8 ¹ / ₄ in 210 mm



Forceps (Dissecting Artery)

Rumel Dissecting Artery Forceps

CODE	DESCRIPTION	LENGTH
16-6761	Curved	9 in 229 mm



Forceps (Dressing)

Adson Bayonet Dressing Forceps

CODE	WORKING DISTANCE	LENGTH
30-1191	3 ⁵ / ₈ in 92 mm	7 ¹ / ₂ in 191 mm



Forceps (Dressing)

Adson Delicate Dressing Forceps

CODE	DESCRIPTION	TIP WIDTH	LENGTH
30-4214	Delicate	0.8 mm	5 in 127 mm

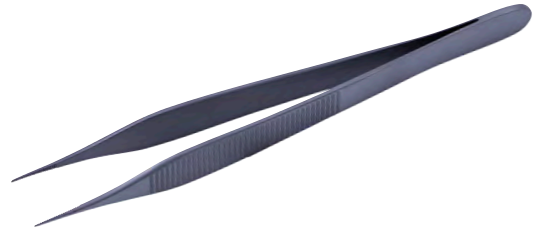

Adson Dressing Forceps

CODE	DESCRIPTION	TIP WIDTH	LENGTH
30-1185	Standard	1.2 mm	5 in 127 mm
30-1190	Standard	2.0 mm	7 in 178 mm

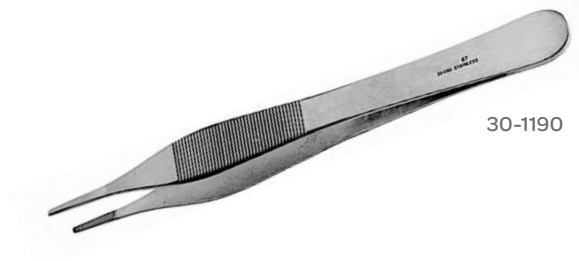

30-1190

Children's Hospital Classic® Delicate Dressing Forceps

CODE	DESCRIPTION	LENGTH
30-4208	Narrow Serrated Tips, Dissecting End	5¾ in 146 mm



Classic Plus® Dressing Forceps

Tungsten Carbide Tip

CODE	TIP WIDTH	LENGTH
36-6010	1.8 mm	6 in 152 mm



Forceps (Dressing)

Cushing Bayonet Dressing Forceps

Serrated, Bayonet Shape, Dissecting End

CODE	TIP WIDTH	LENGTH
30-1156	1.4 mm	7 ³ / ₄ in 197 mm
30-1155	1.8 mm	7 ¹ / ₄ in 184 mm



30-1155

Cushing Dressing Forceps

CODE	DESCRIPTION	TIP WIDTH	LENGTH
30-1152	Extra-Fine, Serrated Handle, Fine Tip	1.3 mm	7 in 178 mm
30-1150	Serrated Handle	1.5 mm	7 in 178 mm
30-1151	Gutsch Handle	1.7 mm	7 in 178 mm
30-1154	8, Serrated	1.8 mm	7 ³ / ₄ in 197 mm



30-1154

Dressing Forceps

Serrated

CODE	TIP WIDTH	LENGTH
30-4133	2.2 mm	5 in 127 mm
30-4134	2.2 mm	5 ¹ / ₂ in 140 mm
30-4135	2.3 mm	6 in 152 mm
30-4137	3.0 mm	8 in 203 mm
30-4138	3.0 mm	10 in 254 mm
30-4139	3.4 mm	12 in 305 mm



30-4138

Ewald-Hudson Dressing Forceps

CODE	TIP WIDTH	LENGTH
30-4215	1.7 mm	5 in 127 mm

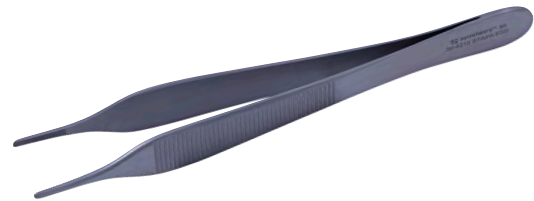

Forceps (Dressing)

Gerald Bayonet Dressing Forceps

Serrated, Bayonet Shape

CODE	WORKING DISTANCE	LENGTH
30-1216	3½ in 89 mm	7½ in 191 mm



Gerald Dressing Forceps

CODE	DESCRIPTION	TIP WIDTH	LENGTH
30-1214	Serrated, Straight	1.1 mm	7 in 178 mm



Hardy™ Dressing Forceps

Bayonet

CODE	WORKING DISTANCE	LENGTH
30-1205	4½ in 114 mm	8¼ in 210 mm

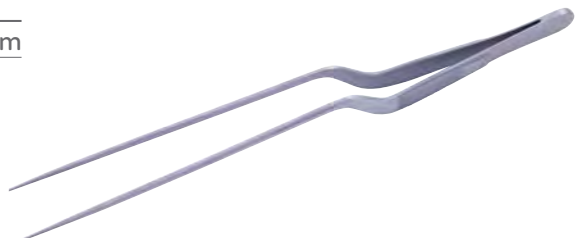

Hoen Bayonet Dressing Forceps

Serrated, Bayonet Shape, Gutsch Handle

CODE	WORKING DISTANCE	LENGTH
30-1165	3 in 76 mm	7¾ in 197 mm

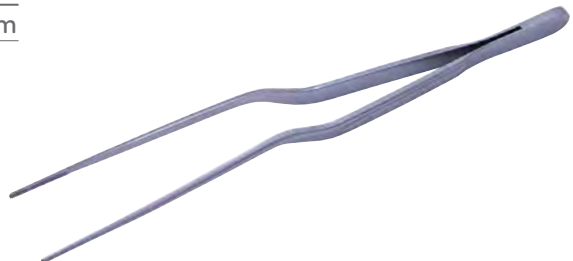

Forceps (Dressing)

Jansen Bayonet Dressing Forceps

Serrated, Bayonet Shape

CODE	WORKING DISTANCE	TIP WIDTH	LENGTH
30-6995	3 1/8 in 79 mm	2.0 mm	6 1/2 in 165 mm
30-1160	4 3/8 in 111 mm	1.8 mm	8 1/2 in 216 mm



MagnaFree® Dressing Forceps

CODE	DESCRIPTION	LENGTH
65-2407	Serrated, Non-Magnetic (Titanium) for Interventional MRI	10 in 254 mm



Potts-Smith Dressing Forceps

CODE	DESCRIPTION	TIP WIDTH	LENGTH
30-8020	Serrated	1.4 mm	7 1/4 in 184 mm
30-8022	Serrated	1.5 mm	9 3/4 in 248 mm
30-8122	Serrated	1.6 mm	12 in 305 mm



Rhoton® Dressing Forceps

CODE	DESCRIPTION	TIP WIDTH	LENGTH
80-1732	Titanium, Serrated Tips	1.8 mm	7 in 178 mm



Semkin Dressing Forceps

CODE	DESCRIPTION	TIP WIDTH	LENGTH
30-1180	Serrated	1.3 mm	5 in 127 mm



Forceps (Straight)

Forceps

Extra Fine Utility Forceps, Titanium

CODE	DESCRIPTION	TIP WIDTH	LENGTH
80-6631	Straight	0.3 mm	6 in 152 mm



80-6631

Forceps

Straight, Titanium, Closing Pressure (Appx) 50 gms

CODE	DESCRIPTION	TIP WIDTH	LENGTH
80-6001	Ring Tip	1.0 mm	6 in 152 mm
80-6002	Ring Tip, Serrated	1.0 mm	6 in 152 mm



80-6002

Forceps (Gallbladder)

Mixer Gallbladder Forceps

CODE	DESCRIPTION	LENGTH
30-4080	Curved	6¼ in 159 mm
30-4081	Curved	7¼ in 184 mm



30-4080

Forceps (Grasping)

Thoracoscopy DeBakey Grasping Forceps

CODE	DESCRIPTION	DIAMETER	LENGTH
54-0006	Straight	10 mm	8¼ in 210 mm

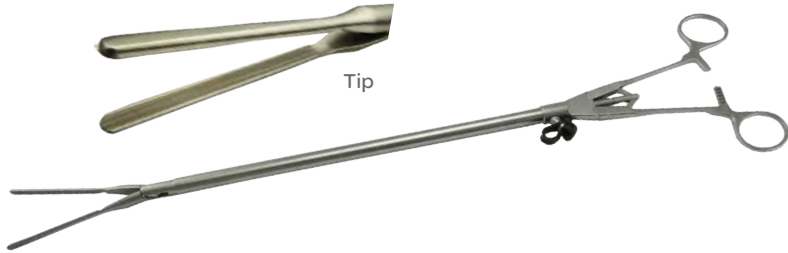

Thoracoscopy Masher Grasping Forceps

CODE	DESCRIPTION	DIAMETER	LENGTH
54-0003	Straight	10 mm	8¼ in 210 mm
54-0004	Curved	10 mm	8¼ in 210 mm
54-0005	Round	10 mm	8¼ in 210 mm



54-0004

Thoracoscopy Pennington Grasping Forceps

CODE	DIAMETER	LENGTH
54-0002	10 mm	5½ in 130 mm



Forceps (Hemostatic)

Adson Hemostatic Forceps

CODE	DESCRIPTION	LENGTH
16-4218	Straight, Delicate Pattern, 1x2 Teeth	7⅞ in 181 mm
16-4318	Curved, Delicate Pattern, 1x2 Teeth	7⅞ in 181 mm



16-4218

Forceps (Hemostatic)

Crile Classic® Delicate Hemostatic Forceps

CODE	DESCRIPTION	LENGTH
30-4467	Straight	5½ in 140 mm
30-4468	Curved	5½ in 140 mm



30-4467

Crile Classic® Hemostatic Forceps

CODE	DESCRIPTION	LENGTH
32-4030	Straight, Standard Line	5½ in 140 mm
32-4040	Straight, Standard Line	6¼ in 159 mm



32-4030

Crile Classic® Hemostatic Forceps

CODE	DESCRIPTION	LENGTH
33-4030	Straight, Bright Finish	5½ in 140 mm
33-4040	Straight, Bright Finish	6¼ in 159 mm
34-4030	Straight, Low-Glare Finish	5½ in 140 mm
34-4040	Straight, Low-Glare Finish	6¼ in 159 mm



34-4030

Crile Hemostatic Forceps

CODE	DESCRIPTION	LENGTH
32-4031	Curved, Standard Line	5½ in 140 mm
32-4041	Curved, Standard Line	6¼ in 159 mm

Forceps (Hemostatic)

Crile Classic® Hemostatic Forceps

CODE	DESCRIPTION	LENGTH
33-4031	Curved, Bright Finish	5½ in 140 mm
33-4041	Curved, Bright Finish	6¼ in 159 mm
34-4031	Curved, Low Glare Finish	5½ in 140 mm
34-4041	Curved, Low Glare Finish	6¼ in 159 mm



33-4031

Halsted Classic® Mosquito Forceps

CODE	DESCRIPTION	LENGTH
33-3900	Straight, Bright Finish	3½ in 89 mm
33-3901	Curved, Bright Finish	3½ in 89 mm
34-3900	Straight, Low-Glare Finish	3½ in 89 mm
34-4000	Straight, Low-Glare Finish	5 in 127 mm
34-3901	Curved, Low-Glare Finish	3½ in 89 mm
34-4001	Curved, Low-Glare Finish	5 in 127 mm



33-3900

Halsted Mosquito Forceps

CODE	DESCRIPTION	LENGTH
32-3900	Straight, Standard Line	3½ in 89 mm
32-3901	Curved, Standard Line	3½ in 89 mm



32-3900

Halsted Mosquito Forceps

CODE	DESCRIPTION	LENGTH
32-4000	Straight, Standard Line	5 in 127 mm
32-4001	Curved, Standard Line	5 in 127 mm



32-4001

Forceps (Hemostatic)

Halsted Classic® Mosquito Forceps

CODE	DESCRIPTION	LENGTH	
33-4000	Straight, Bright Finish	5 in	127 mm
33-4001	Curved, Bright Finish	5 in	127 mm



33-4000

Halsted Hemostatic Forceps

CODE	DESCRIPTION	LENGTH	
30-4039	Curved	7 in	178 mm

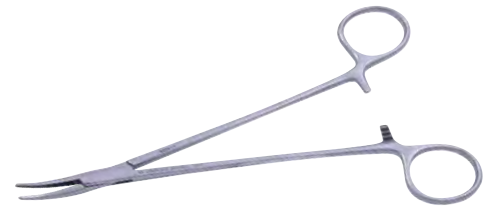

Hoehn Scalp Hemostat

CODE	DESCRIPTION	LENGTH	
30-1115	Serrated, Curved on Side	5 3/8 in	137 mm



Kelly Classic® Hemostatic Forceps

CODE	DESCRIPTION	LENGTH	
32-4020	Straight, Standard Line	5 1/2 in	140 mm
32-4021	Curved, Standard Line	5 1/2 in	140 mm



32-4020

Kelly Classic® Hemostatic Forceps

CODE	DESCRIPTION	LENGTH	
33-4020	Straight, Bright Finish	5 1/2 in	140 mm
33-4021	Curved, Bright Finish	5 1/2 in	140 mm
34-4020	Straight, Low-Glare	5 1/2 in	140 mm
34-4021	Curved, Low-Glare	5 1/2 in	140 mm



33-4020

Forceps (Hemostatic)

Kocher Hemostatic Forceps

CODE	DESCRIPTION	LENGTH
32-4100	Straight, Bright Finish, 1x2 Teeth	5½ in 140 mm



Mixter-Pediatric Hemostatic Forceps

CODE	DESCRIPTION	LENGTH
17-0614	Very Delicate	5¾ in 137 mm
17-0619	Very Delicate	7½ in 191 mm



17-0614

Providence Hospital Hemostatic Forceps

CODE	DESCRIPTION	LENGTH
32-4011	Curved, Bright Finish	5½ in 140 mm



Forceps (Hemostatic)

Rankin Hemostatic Forceps

CODE	DESCRIPTION	LENGTH
32-4050	Straight, Bright Finish	6¼ in 159 mm
32-4051	Curved, Bright Finish	6¼ in 159 mm



32-4050

Rochester-Pean Forceps Hemostatic

CODE	DESCRIPTION	LENGTH
32-3553	Curved	12 in 305 mm
32-3554	Curved	14 in 356 mm

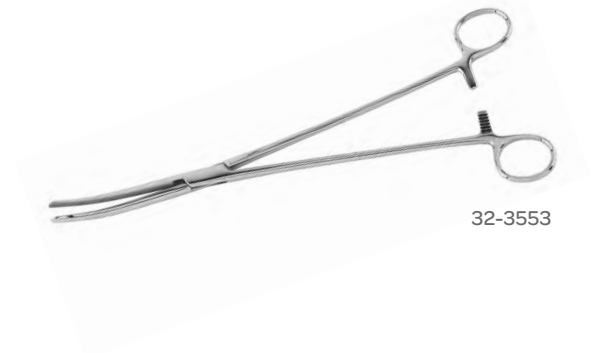

32-3553

Rochester-Ochsner Hemostatic Forceps

CODE	DESCRIPTION	LENGTH
30-4066	Straight	9 in 229 mm



Forceps (I.M.A.)

Jones I.M.A. Forceps

Titanium

CODE	DESCRIPTION	TOOTH SIZE		LENGTH	
80-1851	Straight	0.003 in	0.07 mm	7 in	178 mm
80-1853	Straight	0.004 in	0.01 mm	7 in	178 mm
80-1858	Straight	0.003 in	0.07 mm	8½ in	216 mm
80-1859	Straight	0.004 in	0.01 mm	8½ in	216 mm
80-1852	Bayonet	0.004 in	0.01 mm	8½ in	216 mm
80-1857	Bayonet	0.003 in	0.07 mm	8½ in	216 mm



80-1852

Forceps (Intestinal Forceps)

Single Intestinal Forceps

CODE	DESCRIPTION	LENGTH	
30-4517	Intestinal Forceps, Serrated Fenestrated Jaws	9 in	229 mm

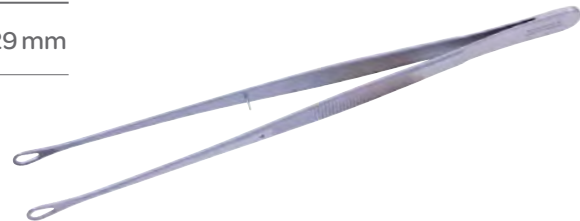

Forceps (Ligature Carrying)

Semb Ligature Carrying Forceps

CODE	DESCRIPTION	LENGTH	
30-8056	Acute Curve	9½ in	241 mm



Forceps (Lung)

Duval Lung Forceps

CODE	JAW WIDTH	LENGTH
30-8095	1 in 25 mm	7 ³ / ₄ in 197 mm



Lovelace Lung Grasping Forceps

CODE	ANGLE	JAW WIDTH	LENGTH
54-5019	One Side	1 in 25 mm	8 in 203 mm



Forceps (Micro)

DeBakey Micro Forceps

Tungsten Carbide Dusted Tip

CODE	DESCRIPTION	JAW WIDTH	LENGTH
55-9019	Counter Balanced Handle	1.0 mm	7 in 178 mm

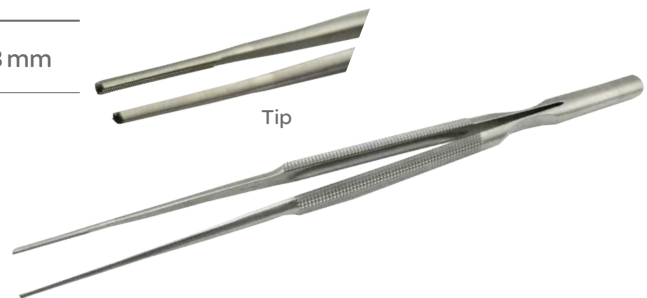

Dennis Micro Forceps

DeBakey Teeth, Counter Balanced Handle

CODE	DESCRIPTION	LENGTH
55-9088	Straight, 1.0 mm Tip	8 in 203 mm



Forceps (Micro)

Titanium Micro Forceps

CODE	DESCRIPTION	LENGTH
55-9086T	Straight, Round Handle	10 in 254 mm



Titanium Micro Ring Forceps

Fine Tungsten Carbide Dust Tips, with Platform, Lightweight Round Handle

CODE	TIP WIDTH	LENGTH
55-9066T	1.0 mm Ring Tip	6 in 152 mm
55-9055T	1.0 mm Ring Tip	7 in 178 mm
55-9056T	1.0 mm Ring Tip	8 ¼ in 210 mm



55-9055T

Titanium Micro Tissue Forceps

Fine Tungsten Carbide Dust Tips, Straight, without Platform

CODE	TIP WIDTH	LENGTH
55-9060T	1.0 mm	7 ½ in 191 mm
55-9062T	1.0 mm	9 in 229 mm



55-9060T

Titanium Ultra™ Micro Ring Tip Forceps

Fine Tungsten Carbide Dust Tips, Counter Balanced Handle

CODE	TIP WIDTH	LENGTH
55-9067T	1.0 mm	7 ¼ in 184 mm
55-9068T	1.0 mm	8 ¼ in 210 mm



55-9067T

Ultra™ Micro Ring Tip Forceps

Fine Tungsten Carbide Dust Tips, Counter Balanced Handle

CODE	DESCRIPTION	TIP WIDTH	LENGTH
55-9067	Straight	1.0 mm	6 in 152 mm
55-9068	Straight	1.0 mm	7 ¼ in 184 mm
55-9069	Straight	1.0 mm	8 ¼ in 210 mm
55-9071	Straight	1.0 mm	9 in 229 mm



55-9067

Forceps (Micro)

Jacobson Micro Artery Forceps

CODE	DESCRIPTION	LENGTH	
16-4088	Straight	7 in	178 mm
16-4189	Full Curve	7 in	178 mm
16-4188	Slight Curve	7 in	178 mm



16-4189

Forceps

Gemini Mixer Forceps

CODE	DESCRIPTION	LENGTH	
54-7262	Curved	14 in	356 mm



Forceps (Hemostatic)

Hemostatic Mosquito Classic®

CODE	DESCRIPTION	LENGTH	
30-4471	Straight, Delicate	4 in	102 mm
30-4473	Straight, Delicate	5 in	127 mm
30-4472	Curved, Delicate	4 in	102 mm
30-4474	Curved, Delicate	5 in	127 mm
30-4470	Curved, Delicate	6 in	152 mm



30-4470

Forceps (Multi-Purpose)

Castaneda Multi-Purpose Clamp

CODE	ANGLE	JAW LENGTH	LENGTH
30-9011	Straight	1 $\frac{3}{8}$ in 35 mm	5 in 127 mm



Forceps

DeBakey Opti-Length® Forceps

CODE	TIP WIDTH	LENGTH
67-7800	1.5 mm	12 in 305 mm
67-7802	1.5 mm	14 in 356 mm
67-7801	2.0 mm	12 in 305 mm
67-7803	2.0 mm	14 in 356 mm



57-7800

Satinsky Opti-Length® Forceps

General Surgery

CODE	TIP WIDTH	LENGTH
67-7584	2.0 mm	10 in 254 mm
67-7586	2.0 mm	12 in 305 mm
67-7585	3.0 mm	10 in 254 mm
67-7587	3.0 mm	12 in 305 mm



67-7584

Forceps (Plaque Forceps)

Plaque Remover

CODE	DESCRIPTION	LENGTH
55-9223	Gentle Curve, Mini	6 in 152 mm
55-9221	Right Angle, Long	7 $\frac{1}{4}$ in 184 mm



55-9223

Forceps (Plaque Forceps)

Wheeler Plaque Forceps

CODE	DESCRIPTION	LENGTH
55-8910	Forceps	5½ in 140 mm
55-8915	Forceps	7¾ in 197 mm



55-8910

Forceps (Right Angle)

Delicate Right Angle Forceps

CODE	DESCRIPTION	LENGTH
54-7275	Full Curved Jaws	5¼ in 133 mm
54-7277	Full Curved Jaws	7¼ in 184 mm



54-7277

Gemini Right Angle Forceps

CODE	DESCRIPTION	LENGTH
54-7266	Right Angle Forceps	16 in 406 mm

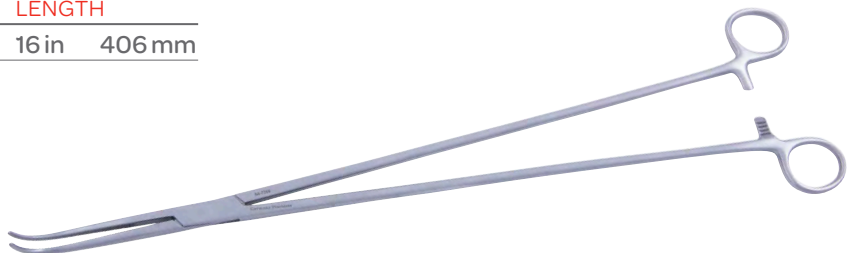

Heiss Right Angle Forceps

CODE	DESCRIPTION	LENGTH
54-7249	Right Angle Forceps	8 in 203 mm

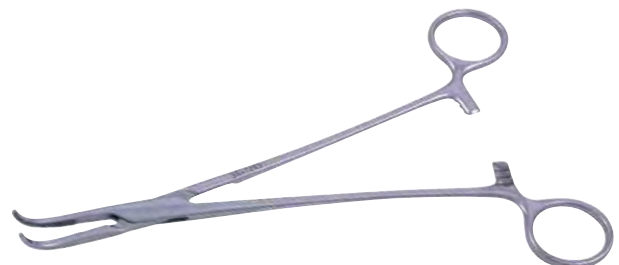

Forceps (Ring Tip Forceps)

Titanium Gerald Ring Tip Forceps

Fine Tungsten Carbide Dust Tips, Flat Handle

CODE	TIP WIDTH	LENGTH
55-9036T	1.0 mm	7 in 178 mm

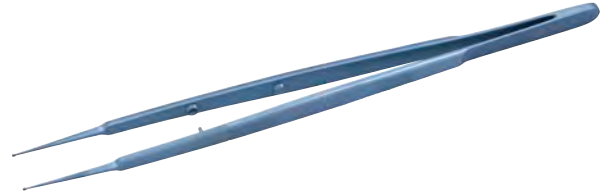

Ultra™ Micro Ring Tip Forceps

Fine Tungsten Carbide Dust Tips, Round Lightweight Handle, with Platform

CODE	DESCRIPTION	LENGTH
55-9041	1.0 mm Tips	7½ in 191 mm
55-9042	1.0 mm Tips	8¼ in 210 mm

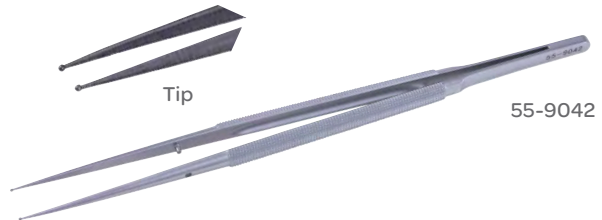

Ultra™ Micro Ring Tip Forceps

Fine Tungsten Carbide Dust Tips, Round Lightweight Handle, without Platform

CODE	DESCRIPTION	LENGTH
55-9055	1.0 mm Tips	7½ in 191 mm
55-9056	1.0 mm Tips	8¼ in 210 mm
55-9057	1.0 mm Tips	9 in 229 mm



Forceps (Sponge)

Bariatric Sponge Forceps

CODE	DESCRIPTION	LENGTH
32-3540	Serrated Jaw, Straight	14 in 356 mm



Forceps (Sponge)

Classic® Sponge Holding Forceps

Serrated Jaws, Bright Finish

CODE	DESCRIPTION	LENGTH
33-6030	Straight	9 in 229 mm
33-6031	Curved	9 in 229 mm



33-6030

Sponge Holding Forceps

Serrated Jaws, Bright Finish

CODE	DESCRIPTION	LENGTH
32-6010	Straight	7 in 178 mm
32-6030	Straight	9 in 229 mm
32-6011	Curved	7 in 178 mm
32-6031	Curved	9 in 229 mm
32-3542	1x2 Teeth	14 in 356 mm

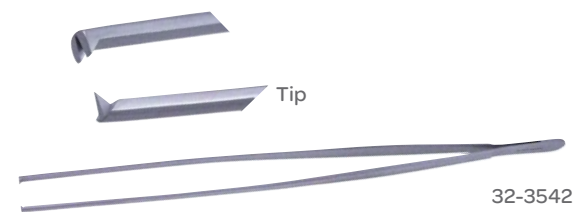

32-3542

Forceps (Stay Suture Clamp)

Gregory Stay Suture Clamp

CODE	DESCRIPTION	LENGTH
19-8026	#1, Gold Band	5/8 in 16 mm



Forceps (Suture Tag)

Castaneda Suture Tag Forceps

Smooth Jaws

CODE	DESCRIPTION	LENGTH
30-9007	#1	3 1/2 in 89 mm
30-9008	#2	3 1/2 in 89 mm
30-9009	#3	3 1/2 in 89 mm
30-9010	#4	3 1/2 in 89 mm



30-9007

Forceps (Thoracic)

Rochester-Pean Thoracic Forceps

CODE	DESCRIPTION	LENGTH
30-8093	Curved, Cross Serrations	12 in 305 mm



Rumel Thoracic Forceps

CODE	DESCRIPTION	LENGTH
30-8070	Slight Curve	9 in 229 mm
30-8072	Full Curve	9 in 229 mm
30-8073	Right Angle	9 in 229 mm



Thoracic Forceps

CODE	DESCRIPTION	LENGTH
30-8082	Delicately Curved	9½ in 241 mm



Julian Thoracic Artery Forceps

Slightly Curved

CODE	JAW LENGTH	LENGTH
37-4034	24 mm	9¼ in 235 mm



Forceps (Thoracic Clamp)

Harrington Thoracic Clamp

Longitudinal Serrations with Cross-Serrated Tips

CODE	DESCRIPTION	LENGTH
30-8049	Right Angled	12 in 305 mm

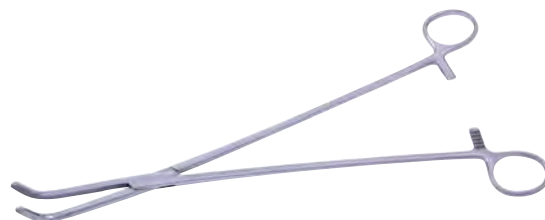

Forceps (Tissue)

Adson Hemostatic Forceps

CODE	DESCRIPTION	LENGTH
30-1010	Straight	7¼ in 184 mm
30-1011	Curved	7¼ in 184 mm



Adson Tissue Forceps

CODE	DESCRIPTION	TIP WIDTH	LENGTH
30-1186	1x2 Teeth	1.2 mm	5 in 127 mm
30-1187	2x3 Teeth	1.8 mm	5 in 127 mm
30-1188	2x3 Teeth	3.0 mm	7 in 178 mm

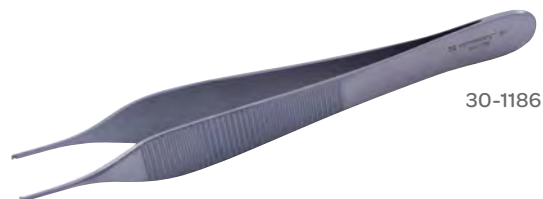

30-1186

Adson Classic Plus® Tissue Forceps

CODE	DESCRIPTION	TIP WIDTH	LENGTH
36-6000	Tungsten Carbide Tip Inserts	2.0 mm	4¾ in 121 mm



36-6000

Forceps (Tissue)

Adson-Brown Tissue Forceps

CODE	TIP WIDTH	LENGTH
30-1189	1.7 mm	5 in 127 mm



Allis Classic® Tissue Forceps

CODE	DESCRIPTION	TEETH	LENGTH
32-7000	Standard Line	4 x 5	6 in 152 mm
32-7001	Standard Line	5 x 6	6 in 152 mm
32-7010	Standard Line	5 x 6	7 ¼ in 184 mm



32-7001

Allis Classic® Tissue Forceps

CODE	DESCRIPTION	TEETH	LENGTH
33-7000	Bright Finish	4 x 5	6 in 152 mm
33-7001	Bright Finish	5 x 6	6 in 152 mm
33-7010	Bright Finish	5 x 6	7 ¼ in 184 mm
34-7000	Low-Glare Finish	4 x 5	6 in 152 mm
34-7001	Low-Glare Finish	5 x 6	6 in 152 mm
34-7010	Low-Glare Finish	5 x 6	7 ¼ in 184 mm



34-7001

Allis Classic® Delicate Tissue Forceps

CODE	DESCRIPTION	TEETH	LENGTH
30-4466	Tissue Forceps	5 x 6	5 in 127 mm



Allis-Adair Tissue Forceps

CODE	DESCRIPTION	LENGTH
30-4542	9 x 10 Teeth	6 in 152 mm



Forceps (Tissue)

Bonney Tissue Forceps

CODE	TEETH	TIP WIDTH	LENGTH
30-1129	1x2	3.0 mm	6¾in 171 mm



Brigham Tissue Forceps

Dissecting End

CODE	TEETH	TIP WIDTH	LENGTH
30-4239	1x2	2.2 mm	5½in 140 mm



Brown Tissue Forceps

Parallel Multiple Teeth

CODE	TIP WIDTH	LENGTH
30-4200	2.2 mm	6¼in 159 mm
30-4201	3.1 mm	8 in 203 mm
30-4202	3.4 mm	10 in 254 mm



Cushing Bayonet Tissue Forceps

Fine Tungsten Carbide Inserts, Bayonet Shape, Dissecting End

CODE	DESCRIPTION	TIP WIDTH	WORKING DISTANCE	LENGTH
30-1146	1x2 Teeth	1.6 mm	3⅜in	7¼in 184 mm
30-1147	1x2 Teeth	1.6 mm	3 in	7¾in 197 mm



Cushing Classic Plus® Bayonet Tissue Forceps

Bayonet Shape, Dissecting End, Fine Tungsten Carbide Inserts

CODE	DESCRIPTION	TIP WIDTH	WORKING DISTANCE	LENGTH
36-6007	7¾in	1.4 mm	3 in 76 mm	7¾in 197 mm



Forceps (Tissue)

Cushing Tissue Forceps

1 x 2 Teeth, Dissecting End

CODE	DESCRIPTION	TIP WIDTH	LENGTH
32-520	Straight		7 $\frac{1}{16}$ in 179 mm
30-1140	Serrated Handle	1.5 mm	7 in 178 mm
30-1142	Gutsch Handle	1.7 mm	7 in 178 mm
30-1143	Gutsch Handle, Fine Tip	1.3 mm	7 in 178 mm

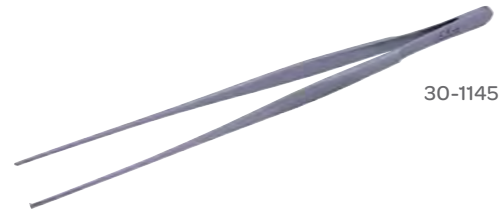

30-1145

Cushing Tissue Forceps

1 x 2 Teeth

CODE	DESCRIPTION	TIP WIDTH	LENGTH
30-1145		1.6 mm	7 $\frac{3}{4}$ in 197 mm

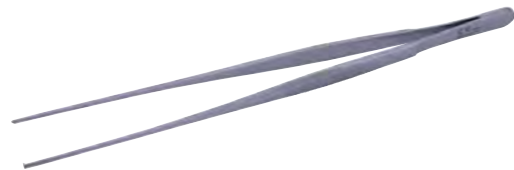

Classic Plus® Cushing Tissue Forceps

Tungsten Carbide Inserts

CODE	DESCRIPTION	TIP WIDTH	LENGTH
32-520	Straight		7 $\frac{1}{16}$ in 179 mm
36-6005	Straight	1.4 mm	7 in 178 mm



36-6005

DeBakey Classic® Vascular Forceps

Tips Taper from 1.5–1.3 mm for the Distal 20 mm

CODE	DESCRIPTION	LENGTH
37-1010	DeBakey Teeth	6 in 152 mm
37-1011	DeBakey Teeth	7 $\frac{3}{4}$ in 197 mm
37-1012	DeBakey Teeth	9 $\frac{1}{2}$ in 241 mm
37-1013	DeBakey Teeth	12 in 305 mm

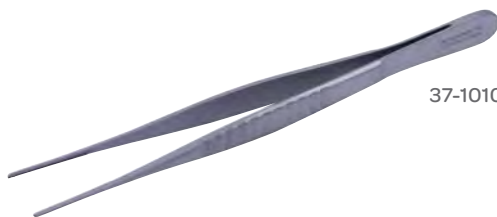

37-1010

DeBakey-Collier Tissue Forceps

CODE	DESCRIPTION	LENGTH
32-3549	Angled, Serrated	14 in 356 mm

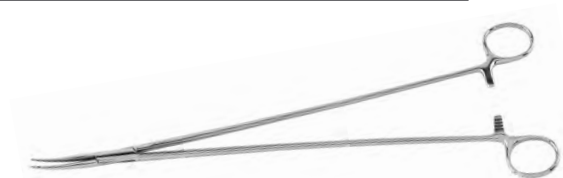

Forceps (Tissue)

DeBakey Needle Pulling Tissue Forceps

CODE	DESCRIPTION	LENGTH
32-559	1.5 mm Tips with	7 ³ / ₈ in 187 mm



DeBakey Thoracic Tissue Forceps

CODE	DESCRIPTION	LENGTH
32-3550	Tissue Forceps	14 in 356 mm



DeBakey Tissue Forceps

Fine Tungsten Carbide Inserts

CODE	DESCRIPTION	LENGTH
32-564	1.5 mm Tips	6 in 152 mm
32-565	1.5 mm Tips	8 ¹ / ₄ in 210 mm
32-566	1.5 mm Tips	9 ⁵ / ₈ in 244 mm
32-561	2.0 mm Tips	7 ⁷ / ₈ in 200 mm
32-562	2.0 mm Tips	9 ¹ / ₂ in 241 mm
32-563	2.0 mm Tips	12 in 305 mm



32-561

DeBakey Tissue Forceps

Tips Taper 2.5–2.0 mm for the Distal 20 mm

CODE	DESCRIPTION	LENGTH
37-1000	DeBakey Teeth	6 in 152 mm
37-1001	DeBakey Teeth	7 ³ / ₄ in 197 mm
37-1002	DeBakey Teeth	9 ¹ / ₂ in 241 mm
37-1003	DeBakey Teeth	12 in 305 mm



37-1001

Forceps (Tissue)

Delicate Adson Tissue Forceps

CODE	TEETH	TIP WIDTH	LENGTH
30-4218	1x2	0.7 mm	5 in 127 mm



D'Errico Bayonet Tissue Forceps

Bayonet Shape

CODE	TEETH	TIP WIDTH	WORKING DISTANCE	LENGTH
30-1201	1x2	2.4 mm	3 3/8 in 86 mm	8 3/4 in 222 mm
30-1203	1x2	2.1 mm	3 1/4 in 83 mm	8 3/4 in 222 mm

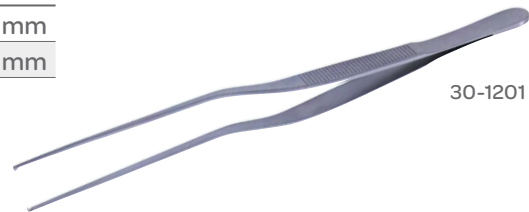

30-1201

Duval Tissue Forceps

Triangular Jaws, Tungsten Carbide Inserts

CODE	JAW WIDTH	LENGTH
36-6055	3/8 in 10 mm	8 1/4 in 210 mm

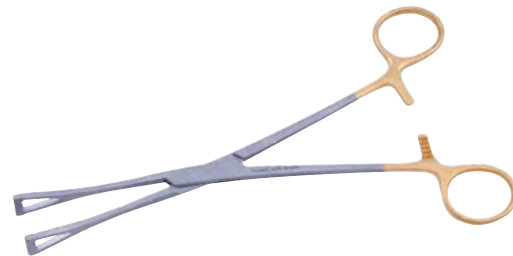

Ewald-Hudson Tissue Forceps

CODE	TEETH	TIP WIDTH	LENGTH
30-4216	1x2	1.6 mm	5 in 127 mm



Ferris Smith Tissue Forceps

CODE	TEETH	TIP WIDTH	LENGTH
30-1132	2x3	3.9 mm	6 3/4 in 171 mm



Forceps (Tissue)

Gemini Tissue Forceps

CODE	DESCRIPTION	LENGTH
32-3546	Serrated Tip	14 in 356 mm

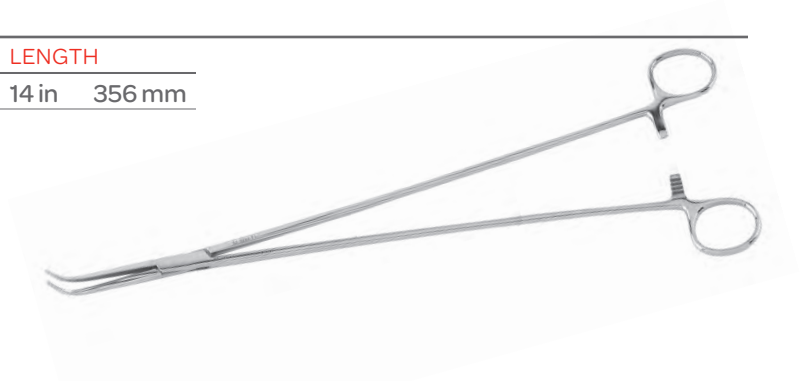

Gerald Tissue Forceps

Bayonet Shape

CODE	TEETH	WORKING DISTANCE	TIP WIDTH	LENGTH
30-1213	1x2	3 ½ in 89 mm	1.3 mm	7 ½ in 191 mm



Gerald Tissue Forceps

CODE	DESCRIPTION	LENGTH
55-9092	DeBakey Teeth	9 ½ in 241 mm



Gerald Tissue Forceps

CODE	TEETH	ANGLE	TIP WIDTH	LENGTH
30-1210	1x2	Straight	1.3 mm	7 in 178 mm



Gerald Tissue Forceps

CODE	DESCRIPTION	LENGTH
55-9002T	Titanium	8 in 203 mm



Forceps (Tissue)

Gerald Tissue Forceps

Tungsten Carbide Insert

CODE	TIP WIDTH	LENGTH
32-3531	1.0 mm	7 in 178 mm
32-3532	1.0 mm	10 in 254 mm



32-3531

Gerald Tissue Forceps

Titanium, with Platform

CODE	TIP WIDTH	LENGTH
55-9017T	1.0 mm	7 in 178 mm



Gerald Tissue Forceps

CODE	DESCRIPTION	LENGTH
55-9000	Serrated	7 in 178 mm
55-9004	Serrated	9½ in 241 mm
55-9005	Serrated	12 in 305 mm
55-9006	Serrated	14 in 356 mm



55-9000

Gerald Tissue Forceps

CODE	DESCRIPTION	LENGTH
55-9001	1x2 Teeth	7 in 178 mm
55-9012	1x2 Teeth	9¼ in 235 mm
55-9013	1x2 Teeth	14 in 356 mm



55-9001

Gerald Tissue Forceps

CODE	DESCRIPTION	LENGTH
55-9048	Cross Serrated Tips	7¾ in 197 mm
55-9044	Cross Serrated Tips	9⅝ in 244 mm



55-9048

Gerald Tissue Forceps

Fine Tungsten Carbide Dust Tips

CODE	DESCRIPTION	LENGTH
55-9043	1.0 mm Tip	8 in 203 mm
55-9049	1.0 mm Tip	7 in 178 mm
55-9017	1.0 mm Tip, with Platform	7 in 178 mm



55-9043

Forceps (Tissue)

Titanium Gerald Tissue Forceps

CODE	DESCRIPTION	LENGTH	
55-9000T	Titanium, Serrated	7 in	178 mm



Gerald-DeDakey Ring Tip Forceps

CODE	TIP SIZE	LENGTH	
55-9036	1.0 mm	7 in	178 mm
55-9037	1.0 mm	8 in	203 mm



55-9036

Gerald-DeBakey Tissue Forceps

DeBakey Teeth

CODE	TIP SIZE	LENGTH	
55-9046	1.0 mm	7 in	178 mm
55-9039	1.0 mm	8 in	203 mm
55-9038	Angled	7 in	178 mm



55-9046

Titanium DeBakey-Gerald Tissue Forceps

Lightweight Round Handle

CODE	TIP SIZE	LENGTH	
55-9046T	1.0 mm	7 ¼ in	184 mm

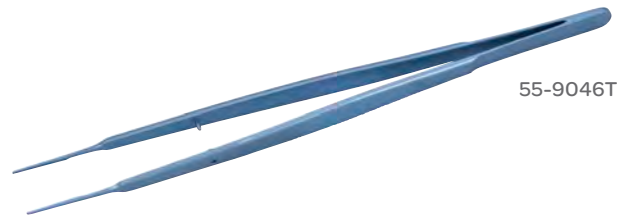

55-9046T

Gerald-DeBakey Tissue Forceps

With DeBakey Teeth, Light Weight Round Handle

CODE	TIP SIZE	LENGTH	
55-9045	1.0 mm	7 ¼ in	184 mm
55-9045T	1.0 mm, Titanium	7 ¼ in	184 mm
55-9035	1.0 mm	8 ¼ in	210 mm
55-9035T	1.0 mm, Titanium	8 ¼ in	210 mm



55-9045

Forceps (Tissue)

Hoen Bayonet Tissue Forceps

1 x 2 Teeth, Bayonet Shape, Gutsch Handle, Working Distance: 3 in (76 mm)

CODE	TIP WIDTH	LENGTH
30-1166	2.1 mm	7 ³ / ₄ in 197 mm

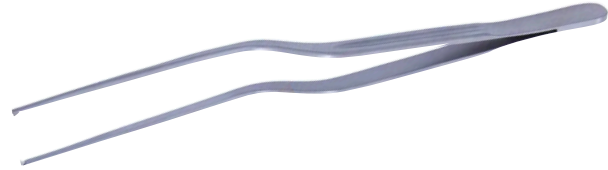

Lockwood-Allis Tissue Forceps

5 x 6 Teeth

CODE	TIP WIDTH	LENGTH
30-4535	³ / ₁₆ in 5.0 mm	6 in 152 mm



MagnaFree® Adson Tissue Forceps

Non-Magnetic, Titanium

CODE	DESCRIPTION	LENGTH
65-2413	1 x 2 Teeth	5 in 127 mm



MagnaFree® Tissue Forceps

Non-Magnetic, Titanium

CODE	TIP WIDTH	LENGTH
65-2420	3.9 mm	5 ¹ / ₂ in 140 mm



Martin Tissue Forceps

CODE	TIP WIDTH	LENGTH
30-4230	6.0 mm	6 in 152 mm
30-4231	6.0 mm	7 in 178 mm



30-4231

Forceps (Tissue)

Mayo-Russian Tissue Forceps

Fenestrated Jaws

CODE	TIP WIDTH	LENGTH
30-8112	6.0 mm	9 in 229 mm

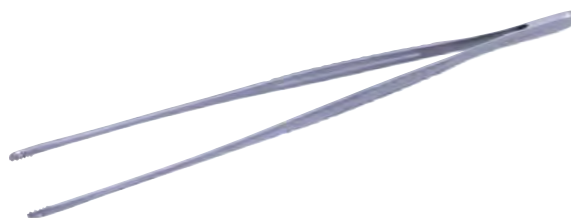

Micro Tissue Forceps, Straight

Fine Tungsten Carbine Dust Tips, 1.0 mm Tips

CODE	DESCRIPTION	LENGTH
55-9058	With Platform, Counter Balanced Handle	7 in 178 mm
55-9061	With Platform, Counter Balanced Handle	8 ¼ in 210 mm
55-9086	With Platform, Counter Balanced Handle	10 in 254 mm
55-9065	With Platform, Lightweight Pattern Round Handle	8 ⅝ in 213 mm
55-9082	With Platform, Lightweight Pattern Round Handle	9 in 229 mm
55-9060	Without Platform, Lightweight Pattern Round Handle	7 ⅞ in 181 mm
55-9062	Without Platform, Counter Balanced Handle	8 ½ in 216 mm



Micro Tissue Forceps, Curved

Fine Tungsten Carbine Dust Tips with Platform, 1.0 mm Tips

CODE	DESCRIPTION	LENGTH
55-9059	Counter Balanced Handle	7 in 178 mm
55-9083	Lightweight Pattern Round Handle	7 ⅞ in 181 mm



Potts-Smith Tissue Forceps

Fine Tungsten Carbide Inserts

CODE	DESCRIPTION	TIP WIDTH	LENGTH
36-6015	Tissue Forceps	1.5 mm	9 in 229 mm

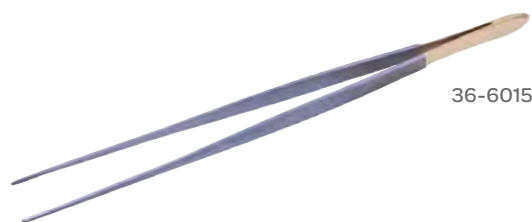

Forceps (Tissue)

Potts-Smith Tissue Forceps

CODE	DESCRIPTION	TIP WIDTH	LENGTH
30-8023	1x2 Teeth	1.7 mm	7¼ in 184 mm
30-8024	1x2 Teeth	1.7 mm	8¼ in 210 mm
30-8123	1x2 Teeth	1.8 mm	12 in 305 mm

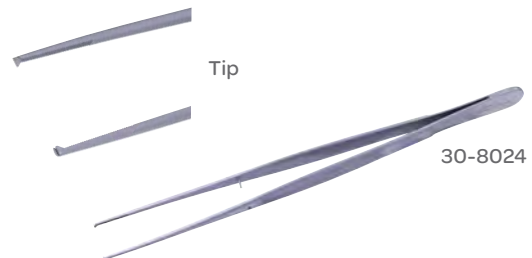

Russian Tissue Forceps

CODE	TIP WIDTH	LENGTH
30-4220	6.0 mm	6 in 152 mm
30-4221	7.0 mm	8 in 203 mm
30-4222	7.2 mm	10 in 254 mm



Bariatric Russian Tissue Forceps

CODE	DESCRIPTION	LENGTH
32-3542	1x2 Teeth	14 in 356 mm
32-3543		14 in 356 mm



Thoms-Allis Tissue Forceps

CODE	TIP WIDTH	LENGTH
30-4554	¼ in 6.0 mm	8½ in 216 mm



Thumb Tissue Forceps

Fine Tungsten Carbide Dust Tips

CODE	TIP WIDTH	LENGTH
55-9020	1.0 mm	6¼ in 159 mm
55-9028	1.0 mm	7½ in 191 mm
55-9026	2.0 mm	7½ in 191 mm
55-9034	2.0 mm	9¾ in 248 mm



Forceps (Tissue)

Bariatric Thumb Forceps

CODE	JAW WIDTH	LENGTH
32-3541	3.4 mm	14 in 356 mm



Tickner Forceps

Fine Tungsten Carbide Inserts

CODE	TIP WIDTH	LENGTH
36-6030	1.8 mm	6 in 152 mm



Tissue Forceps

CODE	DESCRIPTION	TIP WIDTH	LENGTH
30-4151	1x2 Teeth	2.3 mm	5 in 127 mm
30-4152	1x2 Teeth	2.3 mm	5½ in 140 mm
30-4153	1x2 Teeth	2.3 mm	6 in 152 mm
30-4155	1x2 Teeth	3.0 mm	8 in 203 mm
30-4156	1x2 Teeth	3.1 mm	10 in 254 mm
30-4157	1x2 Teeth	3.9 mm	12 in 305 mm
30-4161	2x3 Teeth	3.9 mm	5½ in 140 mm
32-3557	Non-Slip, Round Tip		10 in 254 mm



30-4161

Willauer-Allis Tissue Forceps

CODE	DESCRIPTION	LENGTH
30-8085	Curved	10 in 254 mm



Willauer-Allis Forceps

CODE	TEETH	LENGTH
32-3547	3x3	14 in 356 mm



Forceps (Tube Holding)

Lore Suction Tube Holding Forceps

CODE	DESCRIPTION	LENGTH
30-1280	Tube Holding Forceps	7 in 178 mm



Forceps (Vascular)

Castaneda Vascular Forceps

Titanium, Vascular 1 x 2 Teeth, Grooved with Cross Serrations

CODE	TIP WIDTH	LENGTH
30-8500	1.7 mm	6 in 152 mm



Cooley Vascular Tissue Forceps

CODE	DESCRIPTION	TIP WIDTH	LENGTH
55-2022			6 in 152 mm
55-2023			8 in 203 mm
55-2024			9½ in 241 mm
37-4028	Fine, Cross-Serrated Jaws	1.0 mm	8 in 203 mm
55-2026	Cross Serrated Tip	1.0 mm	8 in 203 mm
55-2027	Cross Serrated Tip	1.0 mm	12 in 305 mm

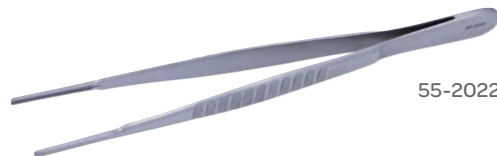

55-2022

DeBakey-Diethrich Vascular Forceps

Tips Taper from 1.5–1.3 mm for the Distal 20 mm

CODE	DESCRIPTION	LENGTH
30-8131	Vascular Forceps	6 in 152 mm
30-8132	Vascular Forceps	7¾ in 197 mm
30-8133	Vascular Forceps	9½ in 241 mm



30-8132

DeBakey-Diethrich Vascular Tissue Forceps

CODE	TIP WIDTH	LENGTH
55-2004	1.0 mm	6 in 152 mm
55-2005	1.0 mm	7¾ in 197 mm
55-2006	1.0 mm	9½ in 241 mm



55-2004

Forceps (Vascular)

DeBakey-Liddicoat Vascular Forceps

Straight, Titanium, 1 x 2 Vascular Teeth

CODE	DESCRIPTION	TIP WIDTH	LENGTH	
30-8400	Fine	1.8 mm	6 in	152 mm
30-8402	Fine	1.8 mm	7 ³ / ₄ in	197 mm
30-8404	Fine	1.8 mm	9 ¹ / ₂ in	241 mm



30-8400

DeBakey-Liddicoat Vascular Forceps

Straight, Titanium, 1 x 2 Vascular Teeth, Regular

CODE	TIP WIDTH	LENGTH	
30-8401	2.25 mm	6 in	152 mm
30-8403	2.25 mm	7 ³ / ₄ in	197 mm



DeBakey Vascular Tissue Forceps

Bayonet

CODE	DESCRIPTION	TIP WIDTH	LENGTH	
55-2000	Straight Tips	2.0 mm	7 in	178 mm

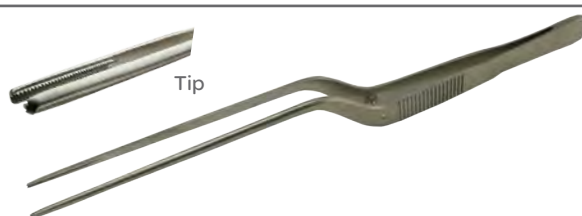

DeBakey Vascular Tissue Forceps

CODE	DESCRIPTION	TIP WIDTH	LENGTH	
55-2007	Straight Tips	2.0 mm	6 in	152 mm
55-2008	Straight Tips	2.0 mm	7 ³ / ₄ in	197 mm
55-2009	Straight Tips	2.0 mm	9 ¹ / ₂ in	241 mm
55-2010	Straight Tips	2.0 mm	12 in	305 mm
55-2030	Straight Tips	2.0 mm	14 in	356 mm
55-2040	Straight Tips	2.0 mm	16 in	406 mm
55-2018	Straight Tips	3.0 mm	6 in	152 mm
55-2019	Straight Tips	3.0 mm	7 ³ / ₄ in	197 mm
55-2020	Straight Tips	3.0 mm	9 ¹ / ₂ in	241 mm
55-2021	Straight Tips	3.0 mm	12 in	305 mm
55-2065	Straight Tips	3.0 mm	14 in	356 mm
55-2075	Straight Tips	3.0 mm	16 in	406 mm
55-2015	Angled Tips	2.0 mm	7 ³ / ₄ in	197 mm
55-2016	Angled Tips	2.0 mm	9 ¹ / ₂ in	241 mm
55-2017	Angled Tips	2.0 mm	11 ³ / ₄ in	298 mm



55-2007

Forceps (Vascular)

DeBakey Vascular Forceps

CODE	DESCRIPTION	TIP WIDTH	LENGTH
55-2008I	Insulated	2.0 mm	7 ³ / ₄ in 197 mm
55-2009E	Ebonized	2.0 mm	9 ¹ / ₂ in 241 mm

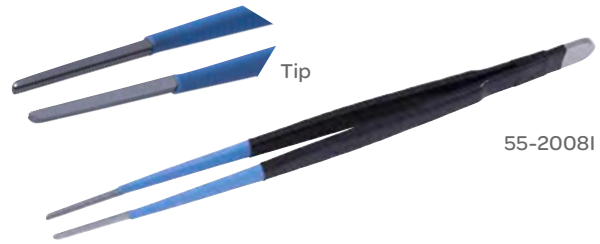

55-2008I

Titanium DeBakey Vascular Tissue Forceps

CODE	TIP WIDTH	LENGTH
55-2004T	1.0 mm	6 in 152 mm
55-2005T	1.0 mm	7 ³ / ₄ in 197 mm
55-2006T	1.0 mm	9 ¹ / ₂ in 241 mm
55-2007T	2.0 mm	6 in 152 mm
55-2008T	2.0 mm	7 ³ / ₄ in 197 mm
55-2009T	2.0 mm	9 ¹ / ₂ in 241 mm

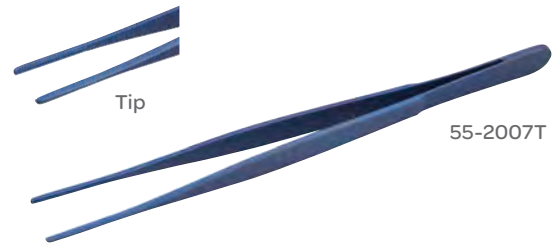

55-2007T

Forceps (Vessel)

Vanderbilt University Vessel Forceps

CODE	DESCRIPTION	LENGTH
30-8018		8 ¹ / ₂ in 216 mm



Forceps

Barnes-Crile Classic® Forceps

CODE	DESCRIPTION	LENGTH
32-4043	Curved, Bright Finish	6 ¹ / ₄ in 159 mm



Forceps

Bridge Forceps

CODE	DESCRIPTION	LENGTH
54-5010	Straight	11 in 279 mm
54-5009	Curved	7½ in 191 mm
54-5011	Curved	11 in 279 mm
54-5021	Curved	14 in 356 mm



54-5009

Coller Forceps

CODE	DESCRIPTION	LENGTH
30-4035	Curved	6¼ in 159 mm
16-5123	90°	9½ in 241 mm



30-4035

Cushing Forceps

Dissector End

CODE	DESCRIPTION	HANDLE	LENGTH
06-6017	Serrated	Flat Serrated	6¾ in 171 mm
06-6018	Serrated	Gutsch	7 in 178 mm
06-6087	1x2 Teeth	Flat Serrated	6¾ in 171 mm
06-6088	1x2 Teeth	Gutsch	7 in 178 mm



06-6087

Delicate Adson Classic® Hemostatic Forceps

CODE	DESCRIPTION	LENGTH
30-4464	Curved	7¼ in 184 mm

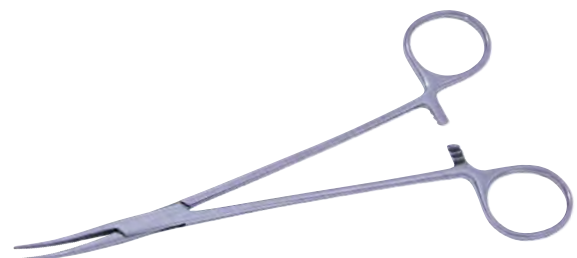

Forceps

Delicate Kocher Classic® Forceps

1x2 Teeth

CODE	DESCRIPTION	LENGTH
30-4490	Straight	5½ in 140 mm
30-4491	Curved	5½ in 140 mm



30-4490

Forceps

Extra Fine Tying Tip, Titanium, Straight

CODE	TIP WIDTH	LENGTH
80-6630	0.7 mm	6 in 152 mm



Forceps

CODE	DESCRIPTION	LENGTH
84-9067	Ceramic Coated, Ring Tip, Round Handle, Straight	7 in 178 mm



Gillies Forceps

Tips with Fine Tungsten Carbide Dust

CODE	TIP WIDTH	LENGTH
55-9016	2.0 mm	8 in 203 mm



Forceps

CVT

Harrington Forceps

CODE	DESCRIPTION	LENGTH
54-5014	Curved	12 in 305 mm



Kantrowitz Forceps

CODE	DESCRIPTION	LENGTH
54-5000	Delicate Right Angle	6½ in 165 mm
54-5003	Delicate Right Angle	7¼ in 184 mm
54-5004	Delicate Right Angle	9¾ in 248 mm
54-5012	Delicate Right Angle	10¾ in 273 mm

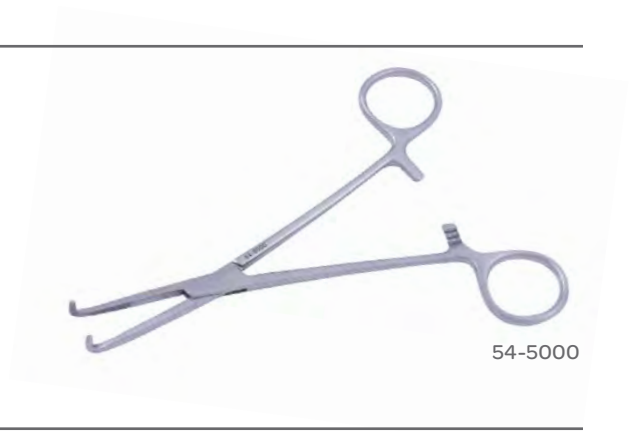

54-5000

Lahey Forceps

With Full Serrations

CODE	DESCRIPTION	LENGTH
30-4020	Straight	5½ in 140 mm
30-4021	Curved	5¾ in 146 mm



30-4020

Lawrence Forceps

CODE	DESCRIPTION	LENGTH
54-5006	Jaws Strongly Curved	7¼ in 184 mm
54-5007	Jaws Strongly Curved	11 in 279 mm



54-5006

Forceps

MagnaFree® Crile Forceps

Non-Magnetic, Titanium

CODE	DESCRIPTION	LENGTH
65-2418	Straight	5½ in 140 mm
65-2419	Curved	5½ in 140 mm



65-2418

MagnaFree® Sponge Forceps

Non Magnetic, Titanium

CODE	DESCRIPTION	LENGTH
65-2415	Straight, Serrated Jaws	9½ in 241 mm

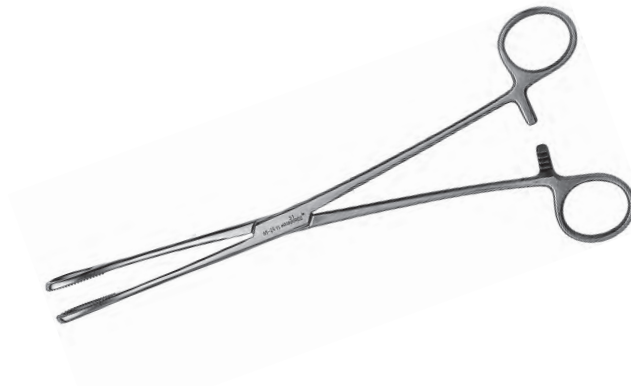

Meeker Forceps

CODE	DESCRIPTION	LENGTH
54-5005	Jaws Angled at 90°	7 in 178 mm
54-7260	Jaws Angled at 90°	10¾ in 273 mm



54-5005

Micro Forceps

Round Handle

CODE	DESCRIPTION	LENGTH
55-9040	1x2 Teeth	7¾ in 187 mm



Tip

Forceps

CVT

Mixer Forceps

CODE	DESCRIPTION	LENGTH
17-0723	Delicate	9½ in 241 mm



Pean Classic® Delicate Hemostatic Forceps

CODE	DESCRIPTION	LENGTH
30-4462	Curved	5½ in 140 mm



"Resano-Type" Forceps

CODE	DESCRIPTION	LENGTH
55-2050T	Titanium, Atraumatic Jaws	9 in 229 mm

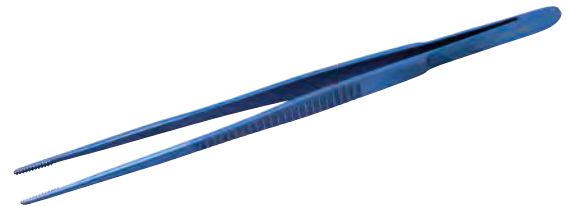

Rochester-Carmalt Forceps

CODE	DESCRIPTION	LENGTH
32-4141	Curved	6½ in 165 mm
32-4151	Curved	8 in 203 mm



Forceps

Rochester-Ochsner Forceps

CODE	DESCRIPTION	TEETH	LENGTH
32-4110	Straight	1x2	6¼ in 159 mm
32-4120	Straight	1x2	7¼ in 184 mm
32-4130	Straight	1x2	8 in 203 mm
30-8090	Straight	1x2	10 in 254 mm
32-4111	Curved	1x2	6¼ in 159 mm
32-4121	Curved	1x2	7¼ in 184 mm
32-4131	Curved	1x2	8 in 203 mm
30-8091	Curved	1x2	10 in 254 mm



Rochester-Ochsner Classic® Forceps

CODE	DESCRIPTION	TEETH	LENGTH
33-4110	Straight, Bright Finish	1x2	6¼ in 159 mm
33-4120	Straight, Bright Finish	1x2	7¼ in 184 mm
33-4130	Straight, Bright Finish	1x2	8 in 203 mm
34-4110	Straight, Low-Glare Finish	1x2	6¼ in 159 mm
34-4120	Straight, Low-Glare Finish	1x2	7¼ in 184 mm
34-4130	Straight, Low-Glare Finish	1x2	8 in 203 mm

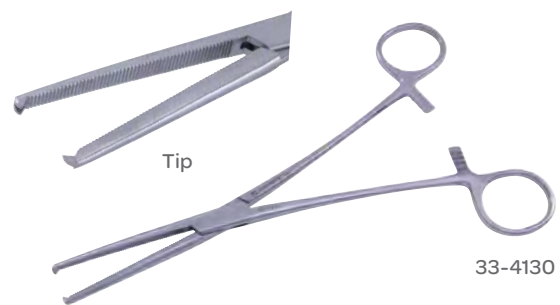

Rochester-Pean Forceps

Cross-Serrations

CODE	DESCRIPTION	LENGTH
30-4563	Straight	9 in 229 mm
30-4565	Curved	9 in 229 mm
30-4573	Curved	10 in 254 mm



Schmidt Forceps

CODE	DESCRIPTION	LENGTH
17-2150	One Open Ring	7½ in 191 mm



Hooks (In-Situ Bypass)

In-Situ Bypass Hook

Angled

CODE	TIP	LENGTH	
55-9072	2.0 mm Rounded	7 in	178 mm
55-9073	3.0 mm Ball	7 in	178 mm



55-9073

Hooks (Varicose Vein)

Varicose Vein Hook

CODE	DESCRIPTION	LENGTH	
13-0004	#4, 7.0 mm	5 in	127 mm



Knife Handles

Knife Handle

CODE	DESCRIPTION	LENGTH	
11-5530	No. 3	4 7/8 in	124 mm
11-5535	No. 3L	8 3/8 in	213 mm
11-5531	No. 4	5 1/4 in	133 mm
11-5534	No. 7	6 1/4 in	159 mm



11-5531

Knives (Sternum)

Lebsche Sternum Knife

CODE	BLADE LENGTH	LENGTH
40-8025	1¼ in 32 mm	9¾ in 248 mm



Loops (Endarterectomy)

Endarterectomy Loops

CODE	DESCRIPTION	LENGTH
55-9215	Set of 6 with Gauges Of: 20, 22, 24, 26, 28 and 30	5⅞ in 130 mm



Markers (Surgical Marker)

Surgical Marker

Gentian Violet Dye, Sterile, Disposable, Packaged with 6 inch Ruler

CODE	DESCRIPTION	QTY
43-1030	Regular Tip	36/Box
43-1032	Micro Tip	36/Box



43-1030

Needle Holders

Jacobson Needle Holders

Straight, Titanium, Smooth Jaws

CODE	DESCRIPTION	LENGTH
80-1866		7 in 178 mm
80-1868		8½ in 216 mm
80-1867	Without Catch	7 in 178 mm
80-1869	Without Catch	8½ in 216 mm



80-1867

Jacobson Needle Holders

CODE	DESCRIPTION	LENGTH
55-2300	Heavy, Round Handle	9 in 229 mm



Slim Line Jacobson Needle Holders

Fine Tungsten Carbide Jaw Inserts, Delicate, Round Handle with Short Knurling

CODE	DESCRIPTION	LENGTH
55-2727	Straight	8¼ in 210 mm
55-2728	Straight, without Lock	8¼ in 210 mm



55-2727

Needle Holders (Micro)

Castroviejo Needle Holders

Fine Tungsten Carbide Dust Tips, Use with 5-0 and 6-0 Suture, Round Handle

CODE	DESCRIPTION	LENGTH
55-2533	Straight, with Lock	5¾ in 146 mm
55-2534	Straight, without Lock	5¾ in 146 mm



55-2533

Needle Holders (Micro)

Jacobson Micro Needle Holders

CODE	DESCRIPTION	TIP WIDTH	LENGTH
80-2002	Straight	0.5 mm	5½ in 140 mm
80-2003	Curved	0.5 mm	5½ in 140 mm

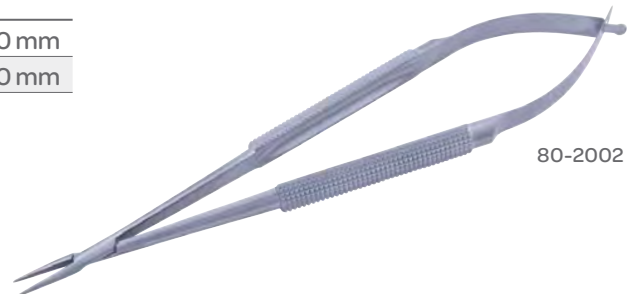

80-2002

Jacobson Micro Needle Holders

Fine Tungsten Carbide Dust Tips, Flat Knurled Handle

CODE	DESCRIPTION	LENGTH
55-2547	Straight	8 in 203 mm



Jacobson Micro Needle Holders

Fine Tungsten Carbide Dust Tips, Round Handle

CODE	DESCRIPTION	LENGTH
55-2549	Curved	9 in 229 mm



55-2549

Jacobson Micro Needle Holders

Fine Tungsten Carbide Dust Tips

CODE	DESCRIPTION	LENGTH
55-2550	Straight, Flat Handle	7 in 178 mm
55-2555	Straight, Flat Handle	7¼ in 184 mm
55-2560	Straight, Flat Handle	8¼ in 210 mm
55-2565	Straight, Flat Handle	9⅜ in 238 mm
55-2566	Straight, Flat Handle without Lock	9½ in 241 mm



Needle Holders (Micro)

Jacobson Micro Needle Holders

Smooth, Jaws, Use with 4-0, 5-0 and 6-0 Suture, with Lock

CODE	DESCRIPTION	LENGTH	
55-2500	Straight	7 in	178 mm
55-2510	Straight	9 in	229 mm



55-2500

Jacobson Micro Needle Holders

Fine Tungsten Carbide Dust Tips, Titanium, Flat Handle

CODE	DESCRIPTION	LENGTH	
55-2555T	Straight	7¼ in	184 mm
55-2556T	Straight, Without Lock	7¼ in	184 mm
55-2565T	Straight	9 in	229 mm
55-2557T	Curved	7¼ in	184 mm
55-2558T	Curved, Without Lock	7¼ in	184 mm
55-2560T	Curved	8½ in	216 mm



55-2560T

Jacobson Micro Needle Holders

Slim Line

CODE	DESCRIPTION	LENGTH	
55-2555T-F	Straight	7¼ in	184 mm
55-2560T-F	Curved	8½ in	216 mm

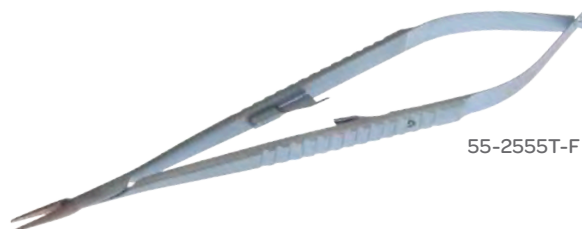

55-2555T-F

Jacobson Double-Action Micro Needle Holders

Fine Tungsten Carbide Dust Tips, Use with 5-0, 6-0 and 7-0 Suture, Round Handle

CODE	DESCRIPTION	LENGTH	
55-2610	Straight	9 in	229 mm
55-2604	Straight, without Lock	7¼ in	184 mm
55-2612	Straight, without Lock	9 in	229 mm
55-2608	Curved, without Lock	7¼ in	184 mm

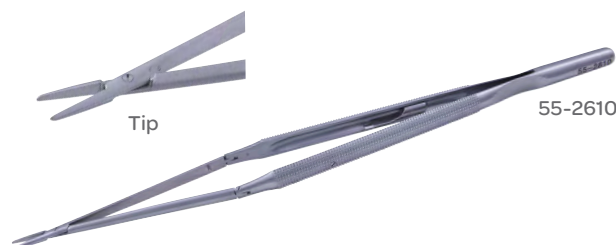

Tip

55-2610

Needle Holders (Micro)

Jacobson Micro Needle Holders

Fine Tungsten Carbide Dust Tips, Delicate, Round Handle with Short Knurling

CODE	DESCRIPTION	LENGTH
55-2527	Straight	8¼ in 210 mm
55-2531	Straight	9 in 229 mm
55-2528	Straight, without Lock	8¼ in 210 mm
55-2532	Straight, without Lock	9 in 229 mm



55-2531

Jacobson Micro Needle Holders

Titanium, Straight

CODE	DESCRIPTION	LENGTH
55-2531T	Delicate	9 in 229 mm
55-2531T-F	Slim Line	9 in 229 mm



55-2531T

Jacobson Micro Needle Holders

Fine Tungsten Carbide Dust Tips, Use with 5-0, 6-0, and 7-0 Suture, Round Handle

CODE	DESCRIPTION	LENGTH
55-2523	Straight, with Lock	7¼ in 184 mm
55-2525	Straight, with Lock	8 in 203 mm
55-2536	Straight, with Lock	9¼ in 235 mm



55-2523

Jacobson Micro Needle Holders

Fine Tungsten Carbide Dust Tips, Use with 5-0 and 6-0 Suture, Round Handle

CODE	DESCRIPTION	LENGTH
55-2524	Straight, without Lock	7¼ in 184 mm
55-2526	Straight, without Lock	8½ in 216 mm
55-2535	Straight, without Lock	9¼ in 235 mm
55-2530	Curved, without Lock	8¼ in 210 mm



55-2526

Jacobson Micro Needle Holders

Fine Tungsten Carbide Dust Tips, Use with 5-0, 6-0 and 7-0 Suture, Round Handle with Lock

CODE	DESCRIPTION	LENGTH
55-2423	Curved	7¼ in 184 mm



Needle Holders

Baumgartner Classic Plus® Needle Holders

CODE	DESCRIPTION	LENGTH
36-2010	Tungsten Carbide Jaw Inserts	5 in 127 mm



Castroviejo Classic Plus® Needle Holders

Fine Tungsten Carbide Jaw Inserts

CODE	DESCRIPTION	LENGTH
36-1000	With Catch	5½ in 140 mm
36-1002	With Catch	7 in 178 mm
36-1001	With Catch	8½ in 216 mm



Classic Plus® Microsurgical Needle Holders with Catch

Smooth Tungsten Carbide Jaw Inserts

CODE	DESCRIPTION	LENGTH
36-1007	With Lock	7 in 178 mm
36-1008	With Lock	8½ in 216 mm



Combination Needle Holders & Forceps

CODE	DESCRIPTION	LENGTH
30-8002	Needle Holders and Forceps	5½ in 140 mm



Needle Holders

Crile-Wood Needle Holders

CODE	DESCRIPTION	LENGTH	
64-2509		6 in	152 mm



Crile-Wood Classic Plus® Needle Holders

CODE	DESCRIPTION	LENGTH	
36-2000	Tungsten Carbide Jaw Inserts	6 in	152 mm
36-2001	Tungsten Carbide Jaw Inserts	7 in	178 mm
36-2002	Tungsten Carbide Jaw Inserts	8 in	203 mm
36-2003	Tungsten Carbide Jaw Inserts	9 in	229 mm
36-2004	Tungsten Carbide Jaw Inserts	10 in	254 mm
36-2005	Tungsten Carbide Jaw Inserts	12 in	305 mm
32-3685	Tungsten Carbide Jaw Inserts	14 in	356 mm



36-2000

Derf Classic Plus® Needle Holders

CODE	DESCRIPTION	LENGTH	
36-1010	Tungsten Carbide Jaw Inserts	5 in	127 mm



Derf Classic Plus® Needle Holders

CODE	DESCRIPTION	LENGTH	
64-2570	Stainless Steel	5 in	127 mm



64-2570

Diethrich Needle Holders

Fine Tungsten Carbide Dust, Ring Handle, Jaw Surfaces, Use with 6-0, 7-0 and 8-0 Suture

CODE	JAW	LENGTH	
55-2570	1.0 mm	5 ¾ in	146 mm



Needle Holders

Extra Fine Needle Holders

Curved, Titanium

CODE	DESCRIPTION	TIP WIDTH	LENGTH
80-6621	Extra Fine Tip	0.5 mm	6 in 152 mm
80-6006	Fine Tip	0.7 mm	6 in 152 mm
80-6007	Standard Tip	1.0 mm	6 in 152 mm



80-6621

Halsey Needle Holders

CODE	DESCRIPTION	LENGTH
64-6558	Smooth Jaws	5 in 127 mm



64-6558

Halsey Classic Plus® Needle Holders

Fine Tungsten Carbide Jaw Inserts

CODE	DESCRIPTION	LENGTH
36-1015	Serrated Jaws	5 in 127 mm
36-1016	Smooth Jaws	5 in 127 mm



36-1015

Heaney Classic Plus® Needle Holders

Fine Tungsten Carbide Jaw Inserts

CODE	DESCRIPTION	LENGTH
36-4010	Curved Tip	8 ¼ in 210 mm



Needle Holders

Heaney Needle Holders

CODE	DESCRIPTION	LENGTH
64-2595	Standard, Curved Tip	8¼ in 210 mm
32-3687	Serrated, Curved Tip	14 in 356 mm



32-3687

I.M.A. Classic Plus® Needle Holders

CODE	DESCRIPTION	LENGTH
36-3018	Straight	6 in 152 mm
36-3019	Straight	7 in 178 mm



36-3018

Julian Classic Plus® Needle Holders

Fine Tungsten Carbide Jaw Inserts

CODE	DESCRIPTION	LENGTH
36-3043	Curved	8¼ in 210 mm
36-3042	Straight	8¼ in 210 mm



36-3042

MagnaFree® MRI Mayo-Hegar Needle Holders

CODE	DESCRIPTION	LENGTH
65-2414	Non-Magnetic (Titanium) For Interventional MRI	7 in 178 mm



Needle Holders

Mayo-Hegar Classic Plus® Needle Holders

CODE	DESCRIPTION	LENGTH	
36-2015	Tungsten Carbide Jaw Inserts	5 in	127 mm
36-2016	Tungsten Carbide Jaw Inserts	6 in	152 mm
36-2017	Tungsten Carbide Jaw Inserts	7 in	178 mm
36-2018	Tungsten Carbide Jaw Inserts	8 in	203 mm
36-2019	Tungsten Carbide Jaw Inserts	10 in	254 mm
36-2020	Tungsten Carbide Jaw Inserts	12 in	305 mm
32-3686	Tungsten Carbide Jaw Inserts	14 in	356 mm



36-2015

Mayo-Hegar Needle Holders

CODE	DESCRIPTION	LENGTH	
64-2512	Stainless Steel Jaws	6 in	152 mm
64-2513	Stainless Steel Jaws	7 in	178 mm
64-2503	Stainless Steel Jaws	8 in	203 mm



64-2503

Microvascular Classic Plus® Needle Holders

CODE	DESCRIPTION	LENGTH	
36-3010	Tungsten Carbide Jaw Inserts	7 in	178 mm



Olsen-Hegar Classic Plus® Needle Holders & Scissors

CODE	DIAMETER	LENGTH	
36-4000	Tungsten Carbide Jaw Inserts	5½ in	140 mm



Needle Holders

Rogers Classic Plus® Needle Holders

Fine Tungsten Carbide Jaw Inserts

CODE	DESCRIPTION	LENGTH
36-4011	Curved Jaws	10 ½ in 267 mm



Rubio Classic Plus® Needle Holders

Fine Tungsten Carbide Jaw Inserts, Offset Handles

CODE	DESCRIPTION	TIP	LENGTH
36-2024	Serrated Jaw	1.14 mm	7 ⅝ in 194 mm



Ryder Needle Holders

Fine Tungsten Carbide Jaw Inserts, Use with 5-0, 6-0 and 7-0 Suture

CODE	DESCRIPTION	LENGTH
55-2660	Ring Handle	6 ½ in 165 mm
55-2662	Ring Handle	7 ¼ in 184 mm
55-2664	Ring Handle	8 ½ in 216 mm

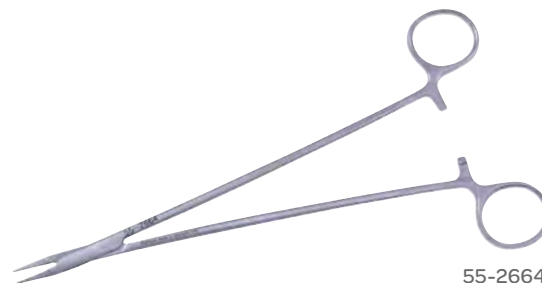

55-2664

Ryder Classic Plus® Needle Holders

Fine Tungsten Carbide Jaw Inserts, Smooth

CODE	JAW WIDTH	LENGTH
36-3022	1.0 mm	5 in 127 mm
36-3007	1.0 mm	6 in 152 mm
36-3008	1.0 mm	7 in 178 mm
36-3009	1.0 mm	9 in 229 mm



36-3007

Needle Holders

Ryder Classic Plus® Needle Holders

Fine Tungsten Carbide Inserts, Serrated Jaws

CODE	TIP SIZE	JAW SIZE	LENGTH
36-3023		1.0 mm	5 in 127 mm
36-3014		1.0 mm	6 in 152 mm
36-3012		1.0 mm	7 in 178 mm
36-3015		1.0 mm	8 in 203 mm
36-3013		1.0 mm	9 in 229 mm



36-3014

Ryder Classic Plus® Needle Holders

Fine Tungsten Carbide Inserts, Serrated Jaws

CODE	TIP SIZE	JAW SIZE	LENGTH
36-3000	1.5 mm	2.0 mm	5 in 127 mm
36-3001	1.5 mm	2.0 mm	6 in 152 mm
36-3002	1.5 mm	2.0 mm	7 in 178 mm
36-3003	1.5 mm	2.0 mm	8 in 203 mm
36-3004	1.5 mm	2.0 mm	9 in 229 mm
36-3005	1.5 mm	2.0 mm	10 in 254 mm



36-3000

Sarot Classic Plus® Needle Holders

CODE	DESCRIPTION	LENGTH
36-3020	Tungsten Carbide Jaw Inserts	7 in 178 mm
36-3021	Tungsten Carbide Jaw Inserts	10 in 254 mm



36-3020

Sternal Classic Plus® Needle Holders & Wire Twister

CODE	DESCRIPTION	LENGTH
36-2025	Tungsten Carbide Jaw Inserts	7 in 178 mm



Needle Holders

Stratte Classic Plus® Needle Holders

Fine Tungsten Carbide Jaw Inserts

CODE	DESCRIPTION	LENGTH
36-4015	Curved Jaw	9 in 229 mm



Thoracoscopy Needle Holders

Straight, Single Action

CODE	DIAMETER	LENGTH
54-0010	5.0 mm	8 ¼ in 210 mm

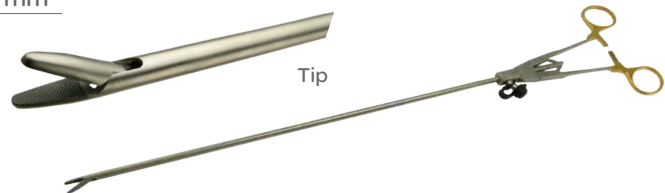

Total Occlusion Classic Plus® Needle Holders

Tungsten Carbide Inserts

CODE	DESCRIPTION	LENGTH
37-4029	Smooth Jaw	4 ¾ in 121 mm



Wangensteen Classic Plus® Needle Holders

CODE	DESCRIPTION	LENGTH
36-4020	Tungsten Carbide Jaw Inserts	10 ½ in 267 mm



Needles

Heparin Needle

CODE	DESCRIPTION
54-6000	2.9 mm Olive Tip
54-6016	3.7 mm Tip Medium



54-6000

Heparin Tip Needles

2/Each

CODE	DESCRIPTION	LENGTH
45-8002	Needle	1 7/8 in 48 mm

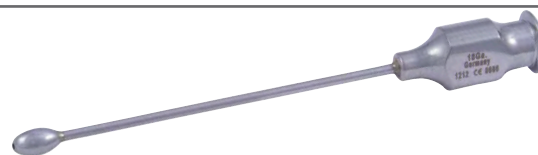

Obturator

Rumel Obturator

CODE	DESCRIPTION
55-5499	Child
55-5498	Adult

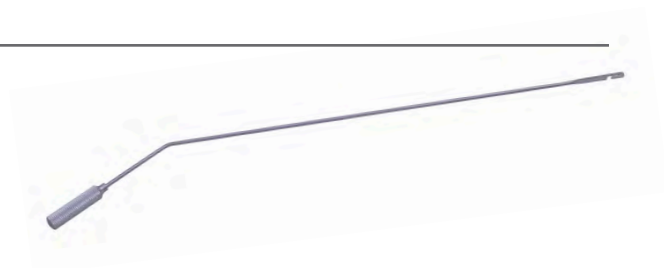

Pliers

Vice Grips

CODE	DESCRIPTION	LENGTH
37-4101	Vice Grips	7 in 178 mm



Pliers

Heavy Duty Lock Pliers

CODE	TIP WIDTH	LENGTH
32-3337	9.0 mm	8 in 203 mm



Needle Nose Pliers

CODE	DESCRIPTION	LENGTH
32-3339	Wire Notch	5½ in 140 mm
37-4100	Wire Notch	6¼ in 159 mm



32-3339

Pliers

CODE	DESCRIPTION	LENGTH
37-4102	Serrated Jaws	6½ in 165 mm



Punches (Sternal Punch)

Sweet Sternal Punch

CODE	DESCRIPTION	LENGTH
51-8006	Hook to Carry Suture Back Through Hole	9½ in 241 mm



Raspatory

Alexander-Farabeuf Rib Raspatory

CODE	DESCRIPTION	LENGTH	
54-3134	Pediatric	6 in	152 mm
54-3135	Adult	8 ¼ in	210 mm



54-3135

Davidson-Alexander Rib Raspatory

CODE	DESCRIPTION	LENGTH	
54-3140	Double-Ended	11 ¾ in	289 mm



Doyen Rib Raspatory

CODE	DESCRIPTION	BLADE LENGTH	LENGTH	
54-3002	Left, Pediatric		6 in	152 mm
54-3001	Right, Pediatric		6 in	152 mm
52-8000	Left, Sharp	1 ⅛ in 29 mm	7 in	178 mm
52-8001	Right, Sharp	1 ⅛ in 29 mm	7 in	178 mm
54-3012	Right, Adult		6 ¾ in	171 mm



52-8000

Matson Rib Raspatory

Double-Ended

CODE	ELEVATOR BLADE	LENGTH	
54-3130	15 mm Wide, Stripper End 22 mm Wide	8 ¾ in	222 mm



Semb Raspatory

CODE	DESCRIPTION	LENGTH	
54-4001	Angled, With Notch	8 in	203 mm
54-4002	Angled, With Notch	9 ¼ in	235 mm
54-4003	Angled, Straight Edge	8 in	203 mm
54-4006	Curved, Round Blade	8 ½ in	216 mm

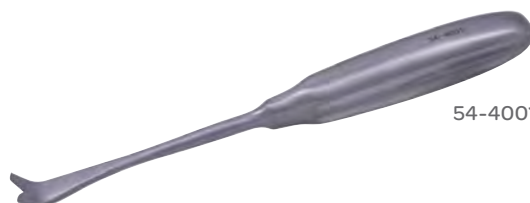

54-4001

Retractors (Aorta)

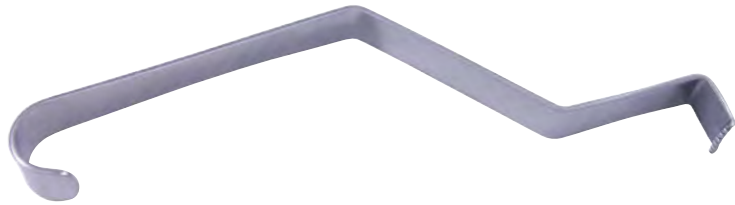

Crawford Aorta Retractor

CODE	DESCRIPTION	TIP WIDTH
55-8008	Small Blade	15 mm

Retractors (Aortic Valve)



50-8012

Liddicoat Aortic Valve Retractor

CODE	DESCRIPTION	BLADE (W X L)	LENGTH
50-8012	Large Aortic Valve Retractor	$\frac{3}{4}$ x $1\frac{1}{8}$ in 19 x 29 mm	$7\frac{3}{4}$ in 197 mm
50-8011	Small Aortic Valve Retractor	$\frac{3}{8}$ x $\frac{3}{4}$ in 10 x 19 mm	$7\frac{3}{4}$ in 197 mm

Retractors (Appendectomy)



50-4130C

Richardson Retractor

CODE	DESCRIPTION	LENGTH
50-4131	Ring-Grip Handle	$\frac{3}{4}$ in 19 mm
50-4130C	Standard Handle	$1\frac{3}{16}$ in 21 mm

Retractors (Atrial Valve)

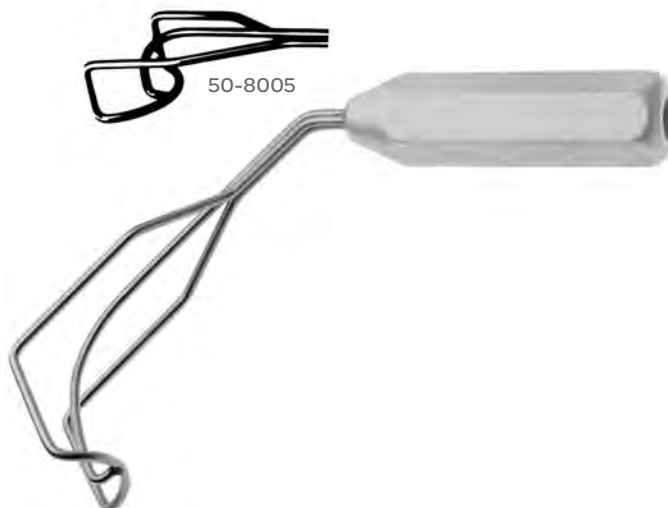
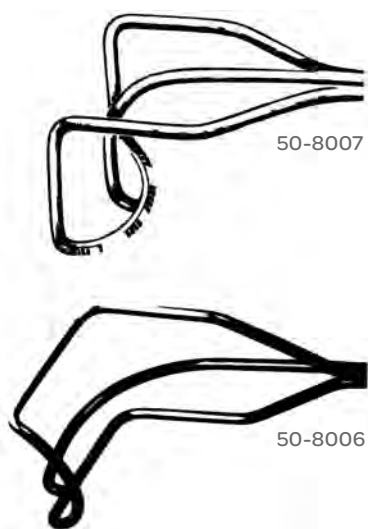

Cooley Atrial Retractor

CODE	DESCRIPTION	BLADE (W X D)		LENGTH	
50-8005	Left	1 ³ / ₄ x 1 in	44 x 25 mm	10 in	254 mm
50-8007	Modified with Teeth	1 ³ / ₄ x 1 ³ / ₄ in	44 x 44 mm	10 in	254 mm
50-8006	Right	1 ³ / ₄ x 1 in	44 x 25 mm	10 in	254 mm
55-8002	Right, Medium Blade	1 ⁵ / ₈ x 1 ³ / ₁₆ in	41 x 30 mm	10 in	254 mm

Retractors (Blades)



Turner-Doyen Retractor

CODE	DESCRIPTION	WIDTH		LENGTH	
32-3628	Blade Retractor	2 ³ / ₈ in	60 mm	5 ¹ / ₂ in	140 mm

Bookwalter® Horizontal Bars

Bookwalter® Lightweight Horizontal Bar

CODE	DESCRIPTION	LENGTH
50-4552	Horizontal Bar	14 ¼ in 362 mm



Bookwalter® Lightweight Horizontal Flex Bar

CODE	DESCRIPTION
50-4582	Horizontal Flex Bar, 360° rotation



Bookwalter® Lightweight Horizontal Flex Bar

CODE	DESCRIPTION
50-4618	Horizontal Bar, Lightweight Design that can be Back Feed into the Bookwalter® Coupler



Bookwalter® Lightweight Extension Bar

CODE	DESCRIPTION	DIMENSION
50-4553	Lightweight Extension Bar	12 in 305 mm
50-4797	Lightweight Extension Bar	18 in 458 mm



50-4553 and 50-4797 require the use of a second Bookwalter® Post Coupler 50-4554

50-4553

Bookwalter® Ironman

CODE	DESCRIPTION
50-4678	Horizontal Ring Holder



Bookwalter® Retractor Blades

Bookwalter® Balfour Blade

CODE	DESCRIPTION	DIMENSIONS (W X L)	
50-4576	Balfour Blade	2 5/8 x 3 in	67 x 76 mm
BW1271017	Balfour Blade	3 1/2 x 2 3/4 in	89 x 70 mm



50-4576

Bookwalter® Harrington Blade

CODE	DESCRIPTION	DIMENSIONS (W X L)	
50-4566	Harrington Blade	2 1/2 x 5 5/8 in	64 x 143 mm
BW1045176	Harrington Blade		



50-4566

Bookwalter® Kelly Blade

CODE	DIMENSIONS (W X L)		CODE	DESCRIPTION	DIMENSIONS (W X L)	
50-4568	2 x 3 in	51 x 76 mm	50-4574		1 x 1 1/2 in	25 x 38 mm
50-4569	2 x 4 in	51 x 102 mm	50-4575		1 x 2 1/2 in	25 x 63 mm
50-4570	2 x 5 in	51 x 127 mm	BW1045000		2 x 8 in	51 x 203 mm
50-4571	2 x 6 in	51 x 152 mm	50-4565	Modified	2 x 1 1/2 in	51 x 38 mm
50-4572	2 x 5 in	51 x 127 mm				



50-4568

Bookwalter® Richardson Blade

CODE	DESCRIPTION	DIMENSIONS (W X L)	
50-4597	Blade	3/4 x 1 in	19 x 25 mm
50-4598	Blade	3/4 x 2 in	19 x 51 mm
50-4599	Blade	1 x 1 1/4 in	25 x 32 mm

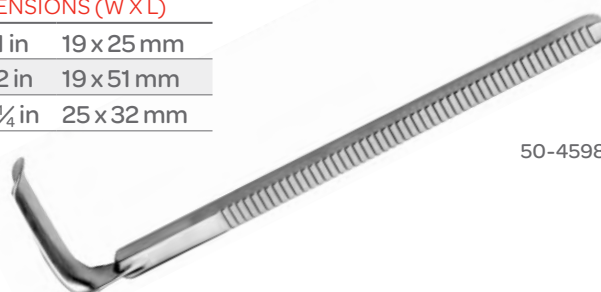

50-4598

Bookwalter® Retractor Blades

Bookwalter® Opti-Length® Malleable Blades

CODE	DESCRIPTION	DIMENSIONS (W X L)	
67-7499	Malleable with Lip, Ebonized	3 x 11 in	76 x 279 mm
67-7500	Malleable with Lip, Ebonized	4 x 11 in	102 x 279 mm
67-7502	Malleable with Lip, Ebonized	1½ x 11 in	38 x 279 mm
67-7504	Malleable with Lip, Ebonized	2 x 11 in	51 x 279 mm



67-7499

Bookwalter® Retractor Blade

Malleable

CODE	DIMENSIONS (W X L)		CODE	DIMENSIONS (W X L)	
50-4562	1½ x 6 in	38 x 152 mm	50-4567	3 x 6 in	76 x 152 mm
50-4561	2 x 6 in	51 x 152 mm	BW1043029	3 x 10 in	76 x 254 mm
BW1043016	2 x 10 in	51 x 254 mm			



50-4561

Bookwalter® Retractor Blade

CODE	DESCRIPTION	DIMENSIONS (W X L)	
50-4694	Bookwalter® Malleable Blade with Lip	1 x 4 in	25 x 102 mm
50-4672	Bookwalter® Malleable Blade with Lip	1½ x 6 in	38 x 152 mm
50-4673	Bookwalter® Malleable Blade with Lip	2 x 6 in	51 x 152 mm
50-4674	Bookwalter® Malleable Blade with Lip	3 x 6 in	76 x 152 mm



50-4672

Bookwalter® Super Malleable Blade With Lip

A malleable blade with a softer flex and tension

CODE	DESCRIPTION	DIMENSIONS (W X L)	
50-4691	Super Malleable with Lip	1 x 4 in	25 x 102 mm
50-4669	Super Malleable with Lip	1½ x 6 in	38 x 152 mm
50-4670	Super Malleable with Lip	2 x 6 in	51 x 152 mm
50-4671	Super Malleable with Lip	3 x 6 in	76 x 152 mm



50-4669

Bookwalter®

Bookwalter® Radiolucent Titanium Blade

Low Glare Gold Coating

CODE	DESCRIPTION	DIMENSIONS (W X L)		CODE	DESCRIPTION	DIMENSIONS (W X L)	
505580	Titanium Blade	1 x 4 in	25 x 102 mm	505585	Titanium Blade	2 x 4 in	51 x 102 mm
505581	Titanium Blade	1 x 5 in	25 x 127 mm	505586	Titanium Blade	2 x 5 in	51 x 127 mm
505582	Titanium Blade	1 x 6 in	25 x 152 mm	505587	Titanium Blade	2 x 6 in	51 x 152 mm
505583	Titanium Blade	1 x 7 in	25 x 178 mm	505588	Titanium Blade	2 x 7 in	51 x 178 mm
505584	Titanium Blade	1 x 8 in	25 x 203 mm	505589	Titanium Blade	2 x 8 in	51 x 203 mm



505580

Bookwalter® Gelpi Retractor

CODE	DESCRIPTION
50-4577	Bookwalter® Gelpi Point (Sharp)



Retractors (Bookwalter® Coupler)

Bookwalter® Lightweight Post Coupling

CODE	DESCRIPTION	LENGTH	
50-4554	Lightweight Post Coupling for Standard 1 in (25 mm) System	1 x 4 in	25 x 102 mm



Bookwalter® Retractor Sets

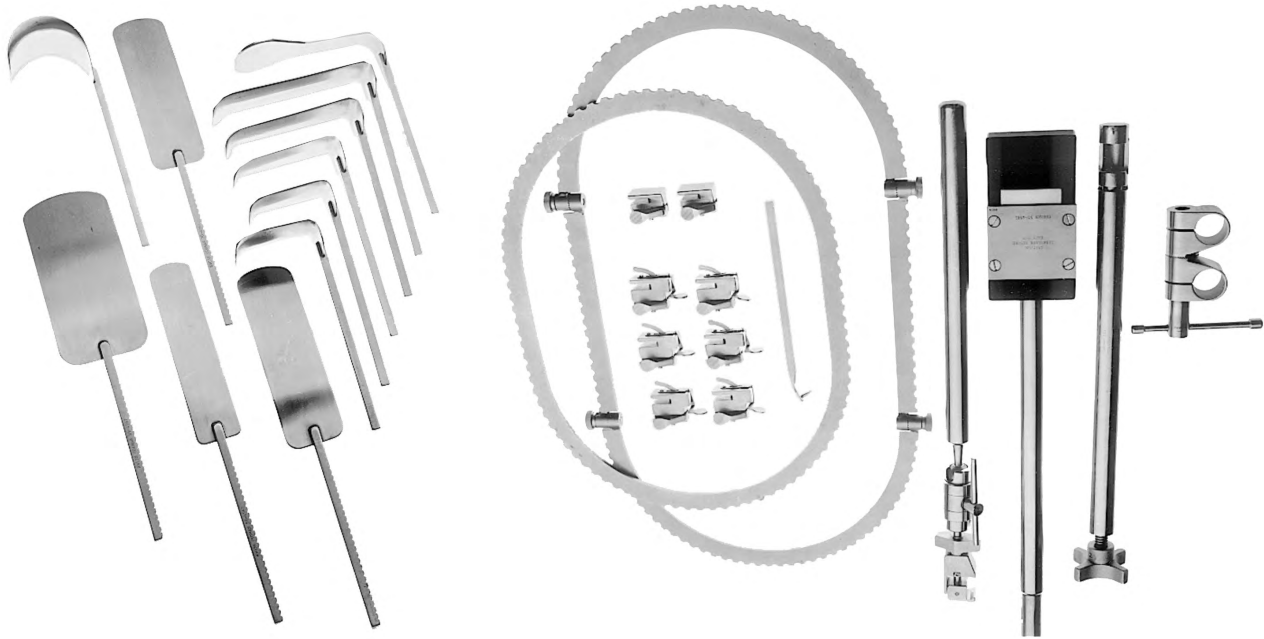

Bookwalter® Retractor Kit II

CODE	DESCRIPTION	QUANTITY
50-4542	Includes Part Numbers and Quantities Listed Below:	
50-4581	Table Post	1
50-4554	Post Coupling	1
50-4552	Horizontal Bar	1
50-4582	Horizontal Flex Bar	1
50-4557	Medium Oval Ring	1
50-4583	Segmented Ring	1
50-4579	Ratchet Mechanisms	2
50-4580	Tilt Ratchet Mechanisms	6
50-4579	Ratchet Mechanisms	2
50-4580	Tilt Ratchet Mechanisms	6
50-4566	Harrington Retractor	1
50-4576	Balfour Retractor	1
50-4568	Kelly Retractors, 2 x 3 in (51 x 76 mm)	2
50-4569	Kelly Retractor, 2 x 4 in (51 x 102 mm)	1
50-4570	Kelly Retractor 2 x 5 in (51 x 127 mm)	1
50-4571	Kelly Retractor 2 x 6 in (51 x 152 mm)	1
50-4562	Malleable Retractor 1½ x 6 in (38 x 152 mm)	1
50-4561	Malleable Retractors, 2 x 6 in (51 x 152 mm)	2
50-4567	Malleable Retractor 3 x 6 in (76 x 152 mm)	1
50-4577	Gelpi Retractor	1
ACCESSORIES		
50-4507	Table Fixation & Ring Case	1
50-4508	Blade & Accessories Case	1

Bookwalter® Retractor Sets

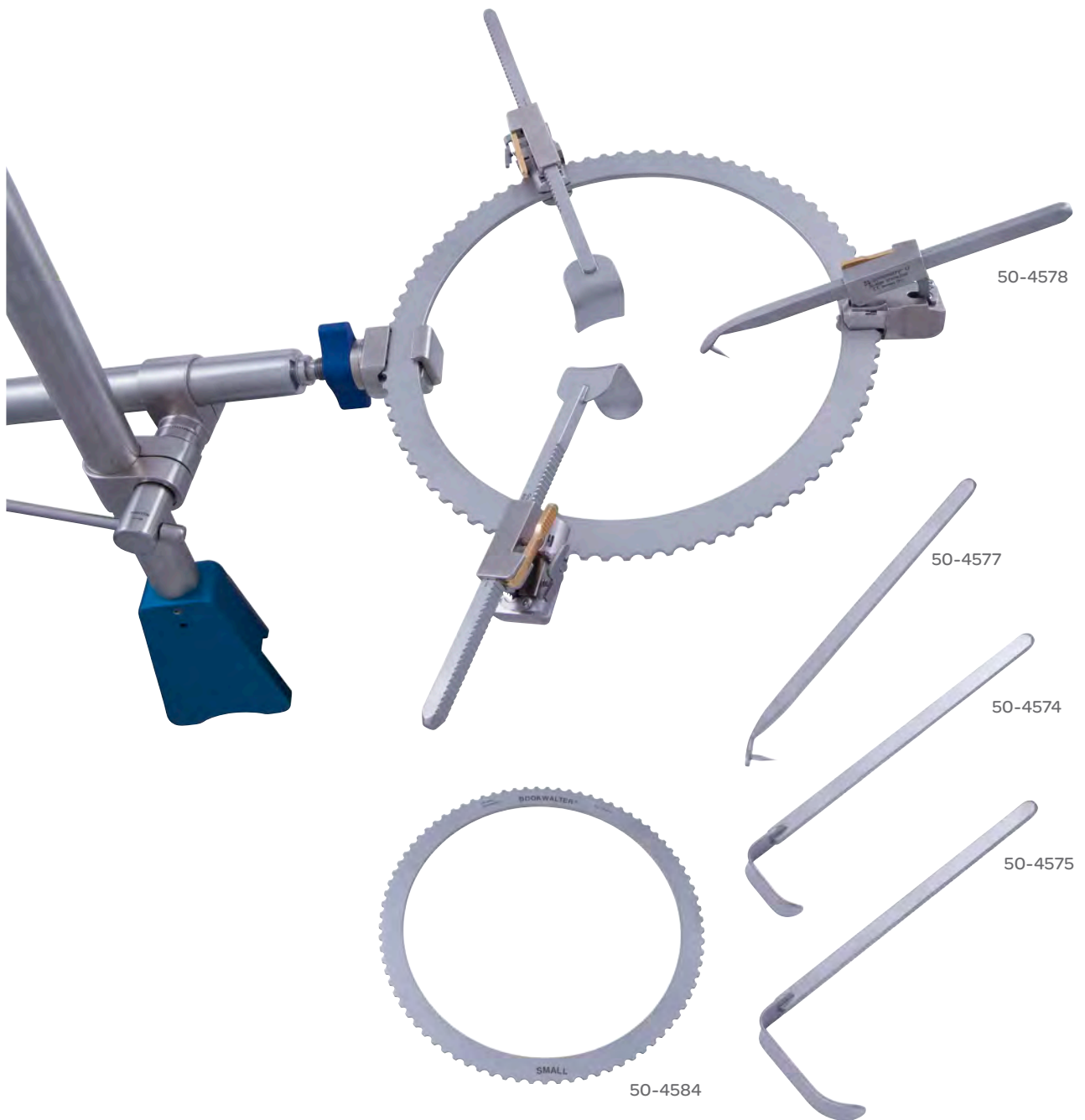

Bookwalter® Small Incision Kit

CODE	DESCRIPTION	LENGTH	
50-4578	Includes Part Numbers Listed Below:		
50-4584	Round Ring	8½ in	216 mm
50-4577	Retractor Gelpi Blade		
50-4574	Kelly Retractor Blades	1x1½ in	25 x 38 mm
50-4575	Kelly Blade	1x2½ in	25 x 64 mm

Bookwalter® Retractor Sets

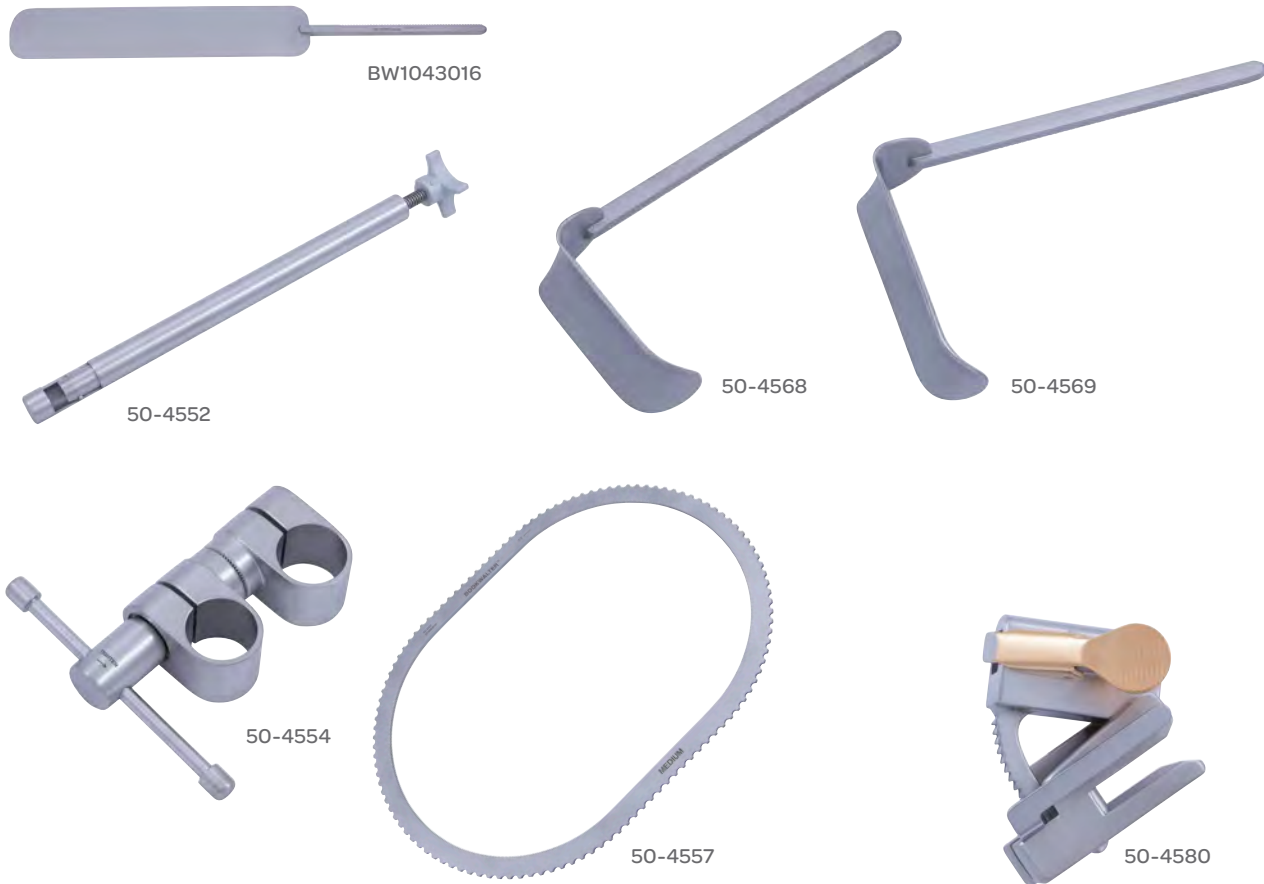

Bookwalter® Obese Patient Retractor System, 18 Inch (458 mm) Table Post

CODE	DESCRIPTION	LENGTH	QUANTITY
BW1046BKIT	Includes Part Numbers Listed Below:		
BW0144005	Table Post Obese Patients		1
BW1043016	Malleable Blade	2 x 10 in 51 x 254 mm	1
BW1043029	Malleable Blade	3 x 10 in 76 x 254 mm	1
BW1045069	Malleable Blade	4 x 8 in 102 x 203 mm	1
BW1045000	Kelly Blade	2 x 8 in 51 x 203 mm	1
BW1271017	Balfour Blade	3 ½ x 2 ¾ in 89 x 70 mm	1
BW1045176	Harrington Blade	3 ½ x 10 in 89 x 254 mm	1
BW0338014	Ratchet Extender		1
BW0338015	Twister Ratchet		1
50-4552	Retractor Horizontal Bar		1
50-4554	Post Coupling	1 x 1 in 25 x 25 mm	1
50-4557	Retractor, Oval Ring Medium		1
50-4568	Kelly Retractor Blades	2 x 3 in 51 x 76 mm	1
50-4569	Kelly Retractor Blades	2 x 4 in 51 x 102 mm	1
50-4580	Tilting Ratchets		6

Bookwalter® Retractor Sets



Bookwalter® Obese Patient Retractor System, 24 Inch (610 mm) Table Post

CODE	DESCRIPTION	LENGTH	QUANTITY
BW1045BKIT	Includes Part Numbers Listed Below:		
BW0144003	Table Post		1
BW1043016	Malleable Blade	2 x 10 in 51 x 254 mm	1
BW1043029	Malleable Blade	3 x 10 in 76 x 254 mm	1
BW1045069	Malleable Blade	4 x 8 in 102 x 203 mm	1
BW1045000	Kelly Blade	2 x 8 in 51 x 203 mm	1
BW1271017	Balfour Blade	3 ½ x 2 ¾ in 89 x 70 mm	1
BW1045176	Harrington Blade	3 ½ x 10 in 89 x 254 mm	1
BW0338014	Ratchet Extender		1
BW0338015	Twister Ratchet		1
50-4552	Horizontal Bar		1
50-4554	Post Coupling	1 x 1 in 25 x 25 mm	1
50-4557	Medium Oval Ring		1
50-4568	Kelly Blade	2 x 3 in 51 x 76 mm	1
50-4569	Kelly Blade	2 x 4 in 51 x 102 mm	1
50-4580	Tilt Ratchets		6

Bookwalter® Retractor Sets



Bookwalter® Obese Patient Accessory Kit, 18 Inch (458 mm) Table Post

CODE	DESCRIPTION	LENGTH		QUANTITY
BW1046BRT	Includes Part Numbers Listed Below:			
BW0144005	Table Post			1
BW1043016	Malleable Blade	2 x 10 in	51 x 254 mm	1
BW1043029	Malleable Blade	3 x 10 in	76 x 254 mm	1
BW1045069	Malleable Blade	4 x 8 in	102 x 203 mm	1
BW1045000	Kelly Blade	2 x 8 in	51 x 203 mm	1
BW1271017	Balfour Blade	3 ½ x 2 ¾ in	89 x 70 mm	1
BW1045176	Harrington Blade	3 ½ x 10 in	89 x 254 mm	1
BW0338014	Ratchet Extender			1
BW0338015	Twister Ratchet			1



Bookwalter® Obese Patient Accessory Kit, 24 Inch (610 mm) Table Post

CODE	DESCRIPTION	LENGTH		QUANTITY
BW1045BRT	Includes Part Numbers Listed Below:			
BW0144003	Table Post			1
BW1043016	Malleable Blade	2 x 10 in	51 x 254 mm	1
BW1043029	Malleable Blade	3 x 10 in	76 x 254 mm	1
BW1045069	Malleable Blade	4 x 8 in	102 x 203 mm	1
BW1045000	Kelly Blade	2 x 8 in	51 x 203 mm	1
BW1271017	Balfour Blade	3 ½ x 2 ¾ in	89 x 70 mm	1
BW1045176	Harrington Blade	3 ½ x 10 in	89 x 254 mm	1
BW0338014	Ratchet Extender			1
BW0338015	Twister Ratchet			1

Bookwalter® Retractor Sets

Bookwalter® Richardson Blade Kit

CODE	DESCRIPTION	LENGTH	
50-4596	Includes 1 each of the following three codes:		
50-4597	Blade	¾ x 1 in	19 x 25 mm
50-4598	Blade	¾ x 2 in	19 x 51 mm
50-4599	Blade	1 x 1¼ in	25 x 32 mm



Bookwalter® I.M.A. T Bar

For use with the Bookwalter® I.M.A. System

CODE	DESCRIPTION
50-4675	Bookwalter® I.M.A., T Bar



Bookwalter® I.M.A. Retractor System

Provides The Tools To Elevate And Retract The Sternum For Efficient Dissection Of The Internal Mammary Artery

CODE	DESCRIPTION	LENGTH		QUANTITY
50-4600	Includes Part Numbers Listed Below:			
50-4552	Horizontal Bar			1
50-4554	Coupler	1 x 1 in	25 x 25 mm	1
50-4581	Table Post	12 in	305 mm	1
50-4601	I.M.A. Cross Bar	12 in	305 mm	1
50-4602	I.M.A. Ratchet			2
50-4603	I.M.A. Rake Retractor, Sharp			2
50-4604	I.M.A. Retractor Case			1



50-6000

Bookwalter® Ratchets

Bookwalter® Ratchet Mechanism

CODE	DESCRIPTION	QTY
50-4579	Basic Ratchet provides simple retraction at 0° angle to the surgical site.	1/Each Sold Individually



Bookwalter® Tilt Ratchet Mechanism

CODE	DESCRIPTION	QTY
50-4580	Tilt ratchet articulates the blade into the surgical site.	1/Each Sold Individually



Bookwalter Rotilt® Ratchet

CODE	DESCRIPTION	QTY
50-4589	The RoTilt Ratchet twists the blade in 7 indexed positions along a 60° arch and has the ability to independently articulate the blade into the surgical site.	1/Each Sold Individually



Bookwalter® Self-Retaining Tilt Ratchet

CODE	DESCRIPTION	QTY
50-4686	Like the 50-4580 this ratchet articulates the blade into the surgical site, it also has an additional self retention latch that holds the ratchet onto the Bookwalter® Retractor Ring.	1/Each Sold Individually



Bookwalter® Ratchets

Bookwalter® Self-Retaining Low Profile Locking Rotilt

CODE	DESCRIPTION	QTY
50-4696	The Bookwalter® Self Retaining Low Profile Locking RoTilt Ratchet bring all of the best features of all other ratchets into one mechanism. The low profile design, inclusive of the capacity to tilt, rotate and self retention it is the one ratchet to build your Bookwalter® Set.	1/Each Sold Individually



Bookwalter® Twister Ratchet

CODE	DESCRIPTION	QTY
BW0338015	The Bookwalter® Twister Ratchet is compatible with all Bookwalter® Ratchets and Retractor Blades. It allows controlled fine tuning of blade position with the simple turn of the key.	1/Each Sold Individually



Bookwalter® Ratchet Extender

CODE	DESCRIPTION
BW0338014	A Bookwalter® Extender provides the surgeon with the extra length that is sometimes needed to get a blade positioned in 'just the right spot.' Can be used with any Bookwalter® Retractor.



Retractors (Bookwalter® Systems)

Bookwalter® Adaptable Ring System

Table Mounted

CODE	DESCRIPTION
504810	System includes the Horizontal Bar and dual ball joint hinge system as well as the Small Round, Medium Round and Medium Oval Ring Segments.
504811	Small Round Ring Segments
504812	Medium Round Ring Segments
504813	Medium Oval Ring Segments



Bookwalter® Adaptable Ring System Bridge

CODE	DESCRIPTION
504687	For use with 50-4810



Bookwalter® Rings

Bookwalter® Elliptical Ring

For Obese Patients

CODE	DESCRIPTION	LENGTH
50-4595	Segmented	14 ½ in x 15 in 368 w x 381 mm



Bookwalter® Rings

Bookwalter® Oval Ring

CODE	DESCRIPTION	LENGTH	
50-4558	Small, Table Mounted	8 x 12 ¼ in	203 x 311 mm
50-4557	Medium, Table Mounted	10 ½ in x 14 ½ in	267 x 368 mm
50-4556	Large, Table Mounted	12 x 18 ½ in	305 x 470 mm

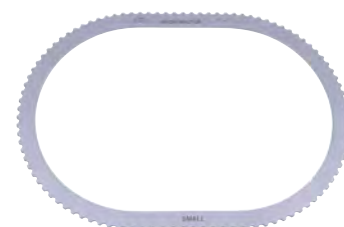

50-4558

Bookwalter® Round Ring Segmented

Table Mounted

CODE	DESCRIPTION	LENGTH	
50-4635	Small, 1 Pair	8 ½ in	216 mm
50-4634	Medium, 1 Pair	10 ½ in	267 mm
50-4633	Large, with Suture Slots	16 in	406 mm



Bookwalter® Round Ring

CODE	DESCRIPTION	LENGTH (INNER DIMENSION)	
50-4584	Small, Table Mounted	8 ½ in	216 mm
50-4559	Medium, Table Mounted	10 ½ in	267 mm
50-4560	Large, Table Mounted	12 ½ in	318 mm



50-4559

Bookwalter® Suture Ring

CODE	DESCRIPTION	LENGTH	
50-4684	Round, Small	9 ½ in	241 mm



50-4684

Bookwalter® Rings

Bookwalter® Segmented Retractor Ring

CODE	DESCRIPTION	DIMENSIONS	
50-4587	Small, Consists of One 8 ½ in Round Ring and Two 4 in Straight Segments	8 ½ x 14 in	216 x 356 mm
50-4583	Medium, Consists of One 10 ½ in Round Ring and Two 8 in Straight Segments	10 ½ x 19 ½ in	267 x 495 mm
50-4588	Large, Consists of One 12 ½ in Round Ring and Two 6 in Straight Segments	12 ½ x 19 ½ in	318 x 495 mm



Bookwalter® Segmented Ring (Straight Segments)

CODE	DESCRIPTION	LENGTH	
50-4636	Straight Ring Segment (Pair)	4 in	102 mm
50-4637	Straight Ring Segment (Pair)	6 in	152 mm
50-4638	Straight Ring Segment (Pair)	8 in	203 mm



Bookwalter® Universal Ring Segmented Ring Screw

CODE	DESCRIPTION	LENGTH	
58-0093X	Table Mounted	8 ½ x 14 in	216 x 356 mm

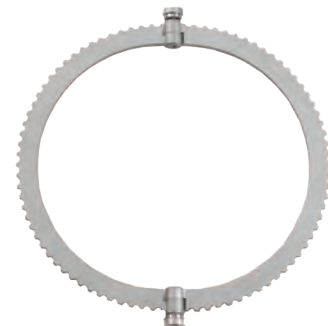

Bookwalter® Table Posts

Violi Gooseneck Table Post

CODE	DESCRIPTION
50-4681	For 1 in (25 mm) System



Bookwalter® Violi Post Holder

CODE	DESCRIPTION	LENGTH
50-4680	For Use with the Violi Gooseneck 50-4681	4 in 102 mm



Bookwalter® Table Post

CODE	DESCRIPTION	LENGTH
50-4683	For 1 in (25 mm) System	8 in 203 mm
50-4581	Table Post	12 in 305 mm
BW0144005	Table Post	18 in 458 mm
BW0144003	Table Post	24 in 610 mm



50-4581

Bookwalter® Lightweight Table Post

CODE	DESCRIPTION	LENGTH
504688	Lightweight Table Post	12 in 305 mm
504697	Lightweight Table Post	16 in 406 mm



50-4688

Retractors (Vision)

Ultra™ Swivel Blade

CODE	DESCRIPTION	LENGTH	
59-8816A	Table Mounted	1 in	25 mm



Ultra™ Blade Loading Locking Retractor Handle

CODE	DESCRIPTION	LENGTH	
59-0105	Table Mounted	8 in	203 mm



Retractors (Abdominal)

Universal Ring Big Boy Retractor Blade

CODE	DESCRIPTION	LENGTH	
58-0021	Fenestrated blade	18 in	458 mm
58-0020	Fenestrated blade	24 in	610 mm



58-0020

Retractors (Abdominal)

Universal Ring Harrington Retractor Blade

CODE	DESCRIPTION	DIMENSIONS	
58-0035	Solid	$\frac{2}{3}$ x 2 $\frac{1}{4}$ in	15 x 57 mm
58-0037	Solid	3 x 10 $\frac{1}{2}$ in	76 x 267 mm



58-0035

Universal Ring Kelly Retractor Blade

CODE	DESCRIPTION	LENGTH	
58-0025	Table Mounted	1 x 3 in	25 x 76 mm
58-0009	Table Mounted	2 $\frac{1}{2}$ x 5 x 3 $\frac{1}{2}$ in	64 x 127 x 89 mm
58-0017T	Titanium, Table Mounted	2 $\frac{1}{2}$ x 8 x 3 $\frac{1}{2}$ in	64 x 203 x 89 mm
58-0016T	Titanium, Table Mounted	3 x 10 $\frac{1}{2}$ in	76 x 267 mm

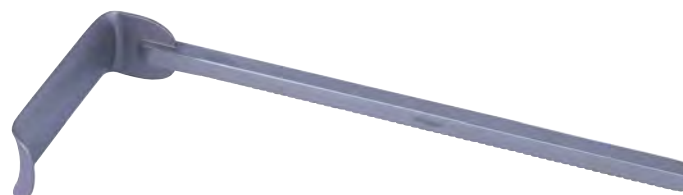

58-0009

Universal Ring Pediatric Harrington Retractor Blade

CODE	DESCRIPTION	LENGTH	
58-0036	Table Mounted	2 x 8 in	51 x 203 mm

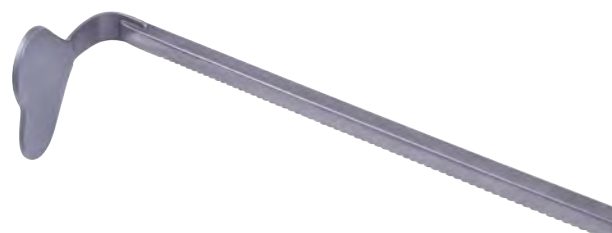

Retractors (Abdominal)

Universal Ring Retractor Blade

CODE	DESCRIPTION	LENGTH
58-0073	Table Mounted, Fence, Rigid	2 x 3 $\frac{3}{4}$ in 51 x 95 mm
58-0044T	Table Mounted, Titanium	3 $\frac{1}{2}$ x 3 $\frac{3}{4}$ in 89 x 95 mm



58-0073

Universal Ring Yu-Holtgrew Retractor Blade

CODE	DESCRIPTION	LENGTH
58-0022	Table Mounted	4 x 5 in 102 x 127 mm

Universal Ring Retractor Blade

CODE	DESCRIPTION	LENGTH
58-0040	Table Mounted, Malleable, with Protective Edge	$\frac{3}{4}$ x 4 in 19 x 102 mm
58-0045	Table Mounted, Malleable, with Protective Edge	2 x 8 in 50 x 203 mm
58-0049	Table Mounted, Malleable, with Protective Edge	3 x 8 in 76 x 203 mm
58-0054	Table Mounted, Malleable, with Protective Edge	6 x 9 in 152 x 279 mm
58-0056	Table Mounted, Malleable, with Protective Edge	4 x 10 in 102 x 254 mm



58-0040

Retractors (Abdominal)

Universal Ring Retractor Blade

CODE	DESCRIPTION	LENGTH
58-0057N	Table Mounted, Malleable	3 x 6 in 76 x 152 mm
58-0044N	Table Mounted, Malleable	2 x 6 in 50 x 152 mm



58-0057N

Universal Ring Elliptical

CODE	DESCRIPTION	LENGTH
58-0100	Table Mounted, Segmented	4 x 10 in 102 x 254 mm



Ultra™ Mayo Swivel Blade

CODE	DESCRIPTION	LENGTH
59-8807A	Table Mounted	2 x 6 in 51 x 152 mm



Retractors (Abdominal)

Ultra™ Side Loading Retractor

CODE	DESCRIPTION	LENGTH	
59-0101	Longitudinal, Table Mounted, with Double Hinge	14 x 15 in	356 x 381 mm
59-0100	Transverse 4 ³ / ₄ in (120 mm) Rack, Table Mounted, with Double Hinge	2 ³ / ₄ x 2 in	70 x 51 mm



59-0100

Retractors (Bookwalter® Internal Mammary Artery)

Bookwalter® I.M.A. Crossbar

CODE	DESCRIPTION	LENGTH	
50-4601	Table Mounted, Small	12 in	305 mm



Retractors (Bookwalter® Internal Mammary Artery)

Bookwalter® I.M.A. "T" Crossbar

CODE	DESCRIPTION
50-4675	

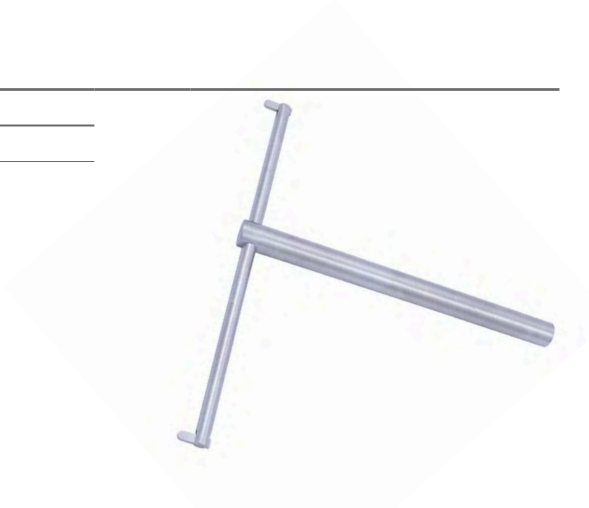

Bookwalter® I.M.A. Retractor Blade

CODE	DESCRIPTION	LENGTH
50-4603		12in 305mm



58-0091

Bookwalter® I.M.A. Retractor Storage Case

CODE	DESCRIPTION	LENGTH
50-4604		



Bookwalter® I.M.A. Ratchet Mechanism

CODE	DESCRIPTION
50-4602	I.M.A. Ratchet Mechanism, Table Mounted



Retractors (Bookwalter®)



Bookwalter® Blades & Accessories Case

CODE	DESCRIPTION	LENGTH	
50-4508	Blades and Accessories Case: Designed to Hold the Following Bookwalter® Components: Sterilization:	3 ¹¹ / ₁₆ x 13 ¹ / ₈ x 22 ¹ / ₈ in 94 x 333 x 562 mm	
50-4579	Case Holds Two-Each Retractor Ratchet Mechanisms		
50-4580	Case Holds Six-Each Tilting Ratchet Mechanisms		
50-4554	Post Coupling	1 x 1 in	25 x 25 mm
50-4566	Harrington Retractor Blades		
50-4571	Kelly Retractor Blades	2 x 6 in	51 x 152 mm
50-4570	Kelly Retractor Blades	2 x 5 in	51 x 127 mm
50-4568	Case Holds Two Each Kelly Retractor Blades	2 x 3 in	51 x 76 mm
50-4569	Kelly Retractor Blades	2 x 4 in	51 x 102 mm
50-4576	Balfour Retractor Blade	2 ⁵ / ₈ x 3 in	67 x 76 mm
50-4577	Retractor Gelpi Blade		
50-4562	Malleable Retractor Blades	1 ¹ / ₂ x 6 in	38 x 152 mm
50-4567	Malleable Retractor Blades	3 x 6 in	76 x 152 mm
50-4561	Case Holds Two Each Malleable Retractors	2 x 6 in	51 x 152 mm

Retractors (Bookwalter®)



50-4507

Bookwalter® Table Fix & Ring Case, 12 Inch (305 mm) Post

CODE	DESCRIPTION
50-4507	Bookwalter® Table Fix & Ring Case, Designed to Hold the Following Bookwalter® Components
50-4581	Table Post
50-4582	Horizontal Flex Bar
50-4552	Retractor Horizontal Bar
50-4583	Medium Segmented Ring
50-4557	Retractor, Oval Ring Medium

Retractors (Carotid)

Henly Carotid Retractor

CODE	DESCRIPTION	LENGTH
55-9050	Retractor Modified Weitlaner with Three Center Blades, Blunt Blades	6½ in 165 mm
55-9050B	Retractor Blades Only	
55-9051	Retractor Frame Only	



Retractors (Epicardial)

I.M.A. Epicardial Retractor

CODE	DESCRIPTION	LENGTH
80-1864	Mini, Gold Coated Retractor	1 in 25 mm
80-1861	Small, Gold Coated Retractor	1⅛ in 29 mm
80-1862	Medium, Gold Coated Retractor	1½ in 38 mm
80-1863	Large, Gold Coated Retractor,	2⅛ in 54 mm
37-4035	Self-Retaining, Light Spring Steel Parsonnet Epicardial Retractor, 3 x 3 Sharp Prongs	1⅞ in 48 mm



Retractors (Four Prong)

Murphy Four Prong Retractor

CODE	DESCRIPTION	BLADE WIDTH	BLADE DEPTH	LENGTH
50-8072	Sharp Four Prong Retractors	1 1/16 in 27 mm	5/16 in 8.0 mm	7 3/4 in 197 mm



Retractors (Sternal)

Castaneda Infant Sternal Retractor

CODE	DESCRIPTION	TOTAL OPENING	BLADE WIDTH	ARM LENGTH	LENGTH
50-8060	Castaneda Small	3 in 76 mm	1 1/16 in 37 mm	2 5/8 in 67 mm	3 in 76 mm
50-8061	Castaneda Large	3 1/2 in 89 mm	2 1/2 in 64 mm	3 in 76 mm	3 1/2 in 89 mm



50-8060

Cooley Infant Sternal Retractor

CODE	DESCRIPTION	SPREAD	BLADE LENGTH	ARM LENGTH	BLADE DEPTH
54-1009	Cooley Aluminum Arms and Blades	4 in 102 mm	3 1/8 in 79 mm	3 1/8 in 79 mm	1/2 in 13 mm



Retractors (Lung)

Allison Lung Retractor

CODE	DESCRIPTION	LENGTH
50-8153	Adult, Large	12½ in 318 mm
54-3505	Adult, 40 mm	10¾ in 273 mm



50-8153

Semb Lung Retractor

CODE	BLADE WIDTH	LENGTH
54-3520	¾ in 20 mm	10 in 254 mm
54-3524	½ in 14 mm	10 in 254 mm



54-3524

Zalkind Lung Retractor

CODE	BLADE DEPTH	LENGTH
55-7220.1	2 in 51 mm	12 in 305 mm
55-7230.1	3 in 76 mm	12 in 305 mm

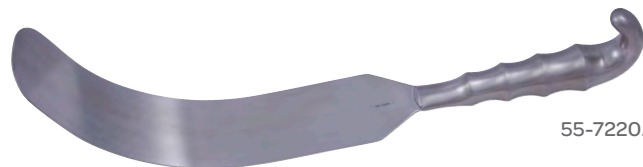

55-7220.1

Retractors (Mini Thoracotomy)

Heitmiller Mini Thoracotomy Retractor

CODE	DESCRIPTION
54-2340	Excellent for Video-Assisted Thoracoscopy



Retractors (Multi-Purpose Peripheral Vascular)

Garrett Multi Purpose Peripheral Vascular Retractor

CODE	DESCRIPTION	TOTAL OPENING		BLADE WIDTH		BLADE DEPTH		LENGTH	
50-8015	Self-Retaining, with Three Blades	3½ in	89 mm	1½ in	38 mm	1¼ in	32 mm	7¼ in	184 mm



Retractors (Popliteal)

Darling Popliteal Retractor

CODE	DESCRIPTION	BLADE WIDTH		BLADE DEPTH		LENGTH	
55-8998	Left, Spread 3¾ in (95 mm)	Small, 1¼ in	32 mm	Small, 2⅞ in	54 mm	6½ in	165 mm
		Large, 1½ in	38 mm	Large, 3 in	76 mm		
55-8997	Right, Direction of Widest Blade Upon Placement Determines Whether Left Or Right	Small, 1¼ in	32 mm	Small, 2⅞ in	54 mm	6½ in	165 mm
		Large, 1½ in	38 mm	Large, 3 in	76 mm		



55-8998

Retractors (Rib)

Burford Rib Retractor

CODE	DESCRIPTION	TOTAL OPENING		BLADE (W X D)	ARM LENGTH		LENGTH	
50-8133	Child Model, Self Retaining with Rack and Pinion Action, Aluminum	6 in	152 mm	Large: 1 ⁵ / ₈ x 1 ⁷ / ₈ in 41 x 48 mm Small: 1 ⁵ / ₈ x 1 ³ / ₈ in 41 x 35 mm	6 in	152 mm	6 in	152 mm
50-8033	Self-Retaining, Two Sets of Detachable Blades, Curved Arms	10 in	254 mm	Large: 2 ¹ / ₂ x 2 ⁵ / ₈ in 64 x 67 mm Small: 2 ¹ / ₂ x 1 ³ / ₄ in 64 x 44 mm	9 ¹ / ₂ in	241 mm	10 in	254 mm
50-8031	Self-Retaining, Two Sets of Detachable Blades, Curved Arms	10 in	254 mm	Large: 2 ¹ / ₂ x 2 ⁴ / ₅ in 64 x 71 mm Small: 2 ¹ / ₂ x 1 ³ / ₅ in 64 x 41 mm	9 ³ / ₄ in	248 mm	10 in	254 mm



50-8133

Cooley Rib Retractor

Aluminum Arms and Blades

CODE	DESCRIPTION	BLADE LENGTH		BLADE DEPTH		SPREAD		ARM LENGTH	
54-2100	Adult	1 ³ / ₈ in	35 mm	1 ³ / ₈ in	35 mm	7 in	178 mm	4 ¹ / ₄ in	108 mm
54-2101	Pediatric	1 in	25 mm	5/8 in	16 mm	4 ³ / ₄ in	121 mm	3 ¹ / ₈ in	79 mm

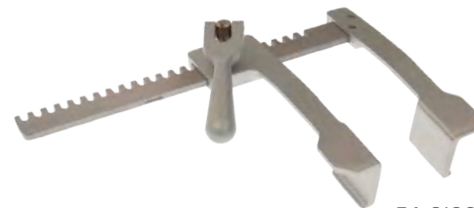

54-2100

Finochietto Rib Retractor

Self-Retaining with Rack and Pinion Action

CODE	DESCRIPTION	TOTAL OPENING		BLADE (W X D)	ARM LENGTH		LENGTH	
50-5625	Infant	2 ¹ / ₂ in	64 mm	3/4 x 1 ³ / ₁₆ in 19 x 30 mm	3 in	76 mm	2 ¹ / ₂ in	64 mm
50-8022		6 ¹ / ₂ in	165 mm	1 ³ / ₄ x 1 ³ / ₄ in 44 x 44 mm	6 in	152 mm	6 in	152 mm



50-5625

Retractors (Rib)

Haight-Finochietto Rib Retractor

Self-Retaining with Rack and Pinion Action

CODE	DESCRIPTION	TOTAL OPENING		BLADE (W X D)		ARM LENGTH		LENGTH	
50-8028	Rib Retractor	4 in	102 mm	1¼ x 1⅜ in	32 x 30 mm	3¼ in	83 mm	4 in	102 mm



Tuffier Rib Retractors

CODE	DESCRIPTION	TOTAL OPENING		BLADE (W X D)		ARM LENGTH		LENGTH	
50-8064	Self-Retaining, Serrated Blades	6½ in	165 mm	1¾ x 2 in	44 x 51 mm	3¼ in	83 mm	1¾ in	44 mm



Finochietto Rib Retractor-Contractor, Infant

Self Retaining with Rack and Pinion Action

CODE	BLADE WIDTH		ARM LENGTH	BLADE DEPTH	TOTAL OPENING		LENGTH	
50-8057	⅞ in	22 mm	3¼ in	83 mm	¾ in	19 mm	3½ in	89 mm



Retractors (Ribbon)

Ribbon Malleable Retractor

CODE	DESCRIPTION	WIDTH		LENGTH	
50-5637	Malleable Retractor	½ in	13 mm	8 in	203 mm
50-5638	Malleable Retractor	⅝ in	16 mm	8 in	203 mm
50-5639	Malleable Retractor	¾ in	19 mm	8 in	203 mm
50-4210	Malleable Retractor	1 in	25 mm	13 in	330 mm
50-4212	Malleable Retractor	1½ in	38 mm	13 in	330 mm
50-4214	Malleable Retractor	2 in	51 mm	13 in	330 mm



50-4210

Ribbon Retractor

Malleable

CODE	DESCRIPTION	WIDTH		LENGTH	
22-0006	Malleable, Stainless Steel	¼ in	6.0 mm	8 in	203 mm
22-0012	Malleable, Stainless Steel	½ in	13 mm	8 in	203 mm
22-0017	Malleable, Stainless Steel	⅝ in	16 mm	8 in	204 mm
22-0027	Malleable, Stainless Steel	1 in	25 mm	10 in	254 mm
22-0252	Malleable, Stainless Steel	1 in	25 mm	13 in	330 mm
22-0253	Malleable, Stainless Steel	1¼ in	32 mm	13 in	330 mm
22-0254	Malleable, Stainless Steel	1½ in	38 mm	13 in	330 mm
22-0255	Malleable, Stainless Steel	2 in	51 mm	13 in	330 mm
22-0256	Malleable, Stainless Steel	2½ in	64 mm	13 in	330 mm
22-0257	Malleable, Stainless Steel	3 in	76 mm	13 in	330 mm
22-0258	Malleable, Stainless Steel	4 in	102 mm	13 in	330 mm
22-0259	Malleable, Stainless Steel	5 in	127 mm	13 in	330 mm



22-0006

Retractors (Scapular)

Davidson Scapular Retractor

CODE	DESCRIPTION	HANDLE LENGTH	BLADE WIDTH	BLADE DEPTH	LENGTH
54-3550	Small		2 in 51 mm	3 in 76 mm	
50-8096		6 in 152 mm	3 ½ in 89 mm	3 in 76 mm	6 in 152 mm

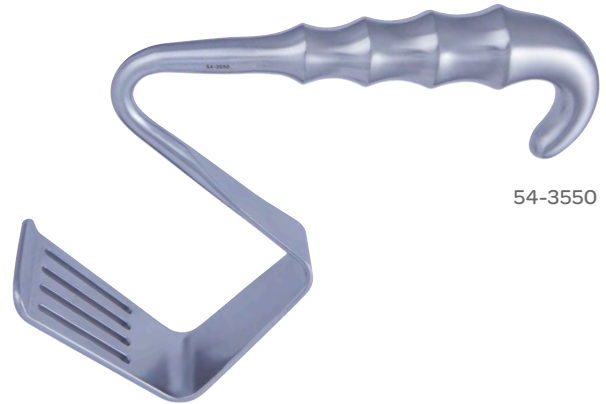

54-3550

Retractors (Self-Retaining)

Balfour Retractor

CODE	DESCRIPTION	LATERAL BLADE WIDTH	LENGTH
50-4503	Fenestrated Blades		1 ¾ in 44 mm
50-4510	Fenestrated Blades	2 ½ in 64 mm	1 ½ in 38 mm
50-4509	Fenestrated Blades	10 ½ in 267 mm	1 ¾ in 44 mm
50-4500	Fenestrated Blades	Self-Retaining with Fixed Lateral Fenestrated Blades and One Center Blade	
50-4514	Two Blades		7 in 178 mm

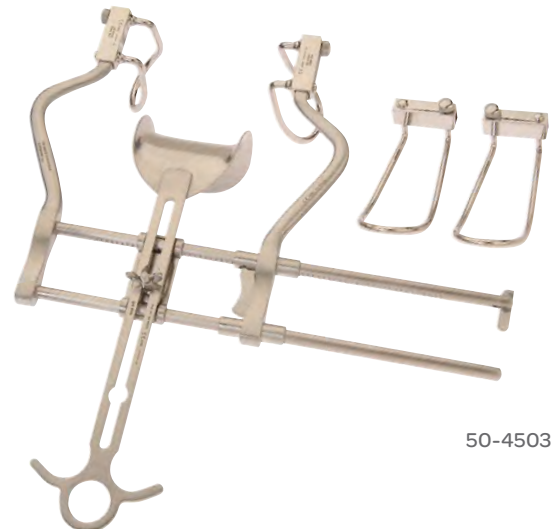

50-4503

Retractors (Self-Retaining)

Henly Self-Retaining Carotid Retractor

CODE	DESCRIPTION	LENGTH
55-8999	Complete Set, with Three Removable Side Blades and Three Removable Center Blades	
55-8999-1	Side Blade Only	1 x $\frac{7}{8}$ in 25 x 22 mm
55-8999-2	Side Blade Only	2 x $\frac{7}{8}$ in 51 x 22 mm
55-8999-3	Side Blade Only	3 x $\frac{7}{8}$ in 76 x 22 mm
55-8999-4	Center Blade Only	$\frac{3}{4}$ x $\frac{5}{8}$ in 19 x 16 mm
55-8999-5	Center Blade Only	1 x $\frac{5}{8}$ in 25 x 16 mm
55-8999-6	Center Blade Only	1 $\frac{1}{2}$ x $\frac{5}{8}$ in 38 x 16 mm
55-8999-7	Center Blade Only	$\frac{5}{8}$ x 3 in 16 x 76 mm
55-8999-8	Center Blade Only	$\frac{5}{8}$ x 2 in 16 x 51 mm



55-8999

Microvascular Modified Alm Retractor

CODE	DESCRIPTION	PRONGS	LENGTH
80-1812	Black Anodized	4 x 4 Prongs	3 in 76 mm
80-1813	Black Anodized	12 x 12 Prongs	3 $\frac{3}{4}$ in 95 mm



80-1813

Retractors (Self-Retaining)

Pediatric Balfour Retractor

CODE	DESCRIPTION	LATERAL BLADE WIDTH
50-5651	Pediatric Balfour Retractor	1 in 25 mm



Weitlaner Retractor

CODE	PRONGS	PRONGS	TOTAL OPENING	LENGTH
50-5647	Self-Retaining Prongs	2 x 3 Prongs, Blunt	2 ¼ in 57 mm	2 ¼ x 4 ½ in 57 x 114 mm
50-5646	Self-Retaining Prongs	2 x 3 Prongs, Sharp	4 ½ in 114 mm	2 ¼ x 4 ½ in 57 x 114 mm
50-1195	Self-Retaining Prongs	3 x 4 Prongs, Blunt	2 ¼ in 57 mm	5 ½ in 140 mm
50-1197	Self-Retaining Prongs	3 x 4 Prongs, Blunt	4 in 102 mm	6 ½ in 165 mm
50-1199	Self-Retaining Prongs	3 x 4 Prongs, Blunt	5 in 127 mm	7 ½ in 191 mm
50-1201	Self-Retaining Prongs	3 x 4 Prongs, Blunt	5 ¾ in 146 mm	9 in 229 mm
50-1194	Self-Retaining Prongs	3 x 4 Prongs, Sharp	2 ¼ in 57 mm	5 ½ in 140 mm
50-1196	Self-Retaining Prongs	3 x 4 Prongs, Sharp	4 in 102 mm	6 ½ in 165 mm
50-1198	Self-Retaining Prongs	3 x 4 Prongs, Sharp	5 in 127 mm	7 ½ in 191 mm
50-1200	Self-Retaining Prongs	3 x 4 Prongs, Sharp	5 ¾ in 146 mm	9 in 229 mm

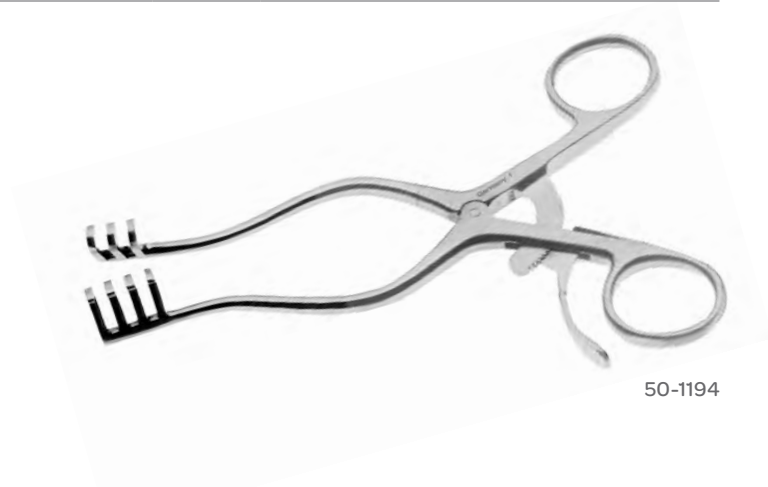

50-1194

Retractors (Splanchnic)

Harrington Splanchnic Retractor

CODE	DESCRIPTION	LENGTH
50-8100	Harrington Splanchnic Retractor	12½ x 1½ in 318 x 38 mm
50-8102	Harrington Splanchnic Retractor	12½ x 1½ in 318 x 38 mm

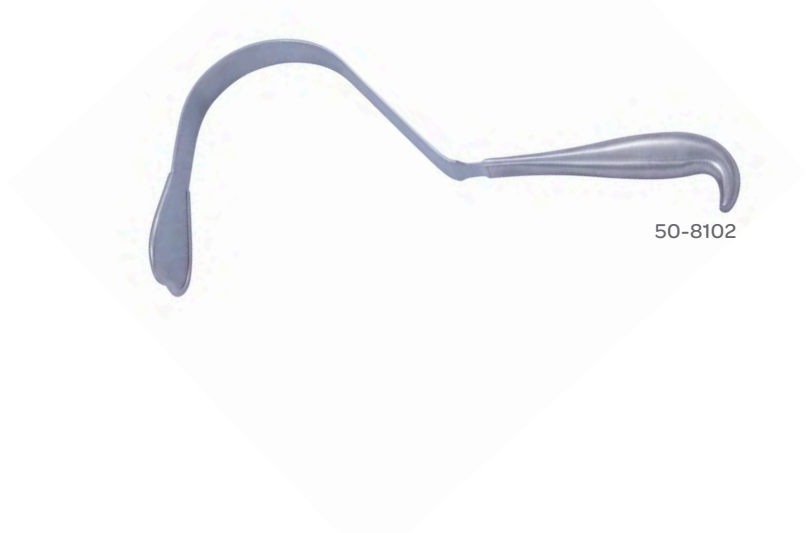

Retractors (Sternal)

Ankeney Sternal Retractor

CODE	PRONGS	TOTAL OPENING	BLADE (W X D)	ARM LENGTH	SPRING LENGTH	LENGTH
50-8068	Child, Aluminum, with Stainless Steel Rack	5 in 127 mm	¾ x 1 in 19 x 25 mm	4 ½ in 114 mm		5 in 127 mm
50-8069	Adult, Self-Retaining with Rack and Pinion Action	7 in 178 mm	1 ¾ x 1 ¼ in 35 x 32 mm	11 ½ in 292 mm	3 ¼ in 83 mm	11 ½ in 292 mm



Retractors (Sternal)

Ankeney Sternal Retractor Blades

for use with 50-8069 and 50-8068

CODE	QTY	BLADE WIDTH		BLADE DEPTH		LENGTH	
50-8070	Set of Six	1 3/8 in	35 mm	2 in	51 mm	8 in	203 mm



Collins Sternal Retractor

CODE	DESCRIPTION	TOTAL OPENING		ARM LENGTH		LENGTH	
50-8080	Self-Retaining w/Rack and Pinion Action, Body Only	8 in	203 mm	8 3/4 in	222 mm	8 1/8 in	206 mm



Cooley Sternal Retractor

CODE	DESCRIPTION	BLADE LENGTH		BLADE DEPTH		SPREAD	
54-1003	Adult Sternal Retractor	2 in	51 mm	1 3/8 in	35 mm	9 1/2 in	241 mm



Retractors (Sternal)

Favaloro-Morse Sternal Retractor

With Two Pair of Fixed Sternal Blades

CODE	TOTAL OPENING	BLADE WIDTH	BLADE DEPTH	ARM LENGTH	LENGTH
50-8090	8 in 203 mm	1 $\frac{1}{8}$ in 29 mm	1 $\frac{1}{2}$ in 38 mm	7 $\frac{5}{16}$ in 186 mm	8 in 203 mm



Himmelstein Sternal Retractor

Self-Retaining with Ratchet Action and Flexible Arms

CODE	TOTAL OPENING	BLADE WIDTH	BLADE DEPTH	ARM LENGTH	LENGTH
50-1133	5 in 127 mm	1 $\frac{3}{8}$ in 35 mm	1 $\frac{1}{4}$ in 32 mm	5 $\frac{1}{4}$ in 133 mm	5 in 127 mm



Morse Sternal Retractor

Adult and Child Self-Retaining with Rack and Pinion Action

CODE	TOTAL OPENING	BLADE WIDTH	BLADE DEPTH	ARM LENGTH	LENGTH
50-8067	8 in 203 mm	1 $\frac{1}{8}$ in 29 mm	1 in 25 mm	7 $\frac{1}{2}$ in 191 mm	8 in 203 mm
50-8066	6 $\frac{1}{4}$ in 159 mm	$\frac{3}{4}$ in 19 mm	$\frac{3}{4}$ in 19 mm	6 in 152 mm	6 $\frac{1}{4}$ in 159 mm



50-8066

Retractors (Sternal)

Pacifico Sternal Retractor

Self-Retaining

CODE	TOTAL OPENING	UPPER & LOWER BLADE WIDTH	LOWER BLADE DEPTH	ARM LENGTH	LENGTH
50-8085	8 in 203 mm	¾ in 19 mm	1½ in 38 mm	6 in 152 mm	8 in 203 mm



Retractors (Tissue)

Tissue Retractors

CODE	PRONGS	TOTAL OPENING	PRONG WIDTH	PRONG DEPTH	LENGTH
501223	3 x 3 Prongs, Blunt	2½ in 64 mm	½ in 13 mm	⅝ in 16 mm	5¼ in 133 mm



Retractors (Vascular)

Ochsner Vascular Retractor

With Swiveling Blades, Self-Retaining and Flexible Arms

CODE	TOTAL OPENING	BLADE WIDTH	BLADE DEPTH	ARM LENGTH	LENGTH
50-8016	5½ in 140 mm	1 in 25 mm	2 in 51 mm	¾ in 83 mm	8 in 203 mm



Retractors (Vascular Spring)

Vascular Spring Retractor

CODE	DESCRIPTION
55-9075	Small
55-9074	Large



55-9075

Retractors (Vein Holder)

Huang Vein Holder

CODE	DESCRIPTION	TIP WIDTH	MAXIMUM DIAMETER	LENGTH
21-8011	Tapering Tip	1.0 mm	$\frac{3}{8}$ in 10 mm	7 in 178 mm



Boley Retractor

CODE	DESCRIPTION	BLADE WIDTH
50-5608	No 1, Double-Ended	$6\frac{1}{4}$ in 159 mm



Children's Hospital Retractor

CODE	DESCRIPTION	BLADE WIDTH
50-4100	Small, Double-Ended	$\frac{7}{16}$ in 11 mm
50-5645	S-Shaped, Double-Ended	$\frac{1}{4}$ in 6.0 mm



50-4100

Retractors (Vein Holder)

Crile Retractor

CODE	DESCRIPTION	BLADE WIDTH	
50-4105	Double-Ended	¼ in	6.0 mm



Cushing Retractor

CODE	JAW LENGTH	LENGTH	
32-3633	10 mm	11 in	279 mm
32-3634	11 mm	14 in	356 mm



32-3633

Deaver Retractor

CODE	DESCRIPTION	HANDLE	LENGTH	
50-4303	No 1	Standard Handle	12 x 1 in	305 x 25 mm
50-4304	No 2	Standard Handle	13 x 1 in	330 x 25 mm
50-4306	No 3	Standard Handle	12 x 1½ in	305 x 38 mm
50-4307	No 4	Standard Handle	12 x 2 in	305 x 51 mm
50-4308	No 5	Standard Handle	12 x 3 in	305 x 76 mm
50-4316	No 1	Ring Grip Handle	1 in	25 mm
50-4317	No 2	Ring Grip Handle	1 in	25 mm
50-4319	No 3	Ring Grip Handle	1½ in	38 mm
50-4320	No 4	Ring Grip Handle	2 in	51 mm
50-4321	No 5	Ring Grip Handle	3 in	76 mm



50-4307

Retractors (Vein Holder)

Deaver Obese Retractor

CODE	DESCRIPTION	BLADE LENGTH	LENGTH
32-3635	Self-Retaining with Ratchet Action and Flexible Arms	2 ½ in 64 mm	14 ½ in 368 mm



Deaver Pediatric Retractor

CODE	DESCRIPTION	BLADE SIZE
50-5631	Standard Handle	8 x 2 ½ x 1 in 203 x 64 x 25 mm
50-5629	Standard Handle	8 x 2 ½ x 1 in 203 x 64 x 25 mm
50-5630	Standard Handle	8 x 2 ½ x 1 in 203 x 64 x 25 mm



50-5631

Goelet Retractor

CODE	DESCRIPTION	BLADE WIDTH
50-4095	Double-Ended	1 ¼ in 32 mm



Henley Retractor Set

CODE	DESCRIPTION
32-3652	Complete Set, 3 Pair Side Blades, 4 Center Blades



32-3652

Retractors (Vein Holder)

Kelly Retractor

CODE	DESCRIPTION	HANDLE	BLADE WIDTH	
50-4110	Small	Standard Handle	1½ in	38 mm
50-4111	Medium	Standard Handle	2 in	51 mm
50-4112	Large	Standard Handle	2½ in	64 mm
50-4115	Small	Ring Grip Handle	1½ in	38 mm
50-4116	Medium	Ring Grip Handle	2 in	51 mm
50-4117	Large	Ring Handle	2½ in	64 mm
50-4118	Extra Large	Ring Handle	3 in	76 mm



50-4110

Mathieu Retractor

CODE	DESCRIPTION	PRONG WIDTH
50-4291	Double-Ended, Three Prong Blade, Blunt	¾ in 10 mm
50-4290	Double-Ended, Three Prong Blade, Sharp	¾ in 10 mm



50-4291

Ollier Retractor

CODE	DESCRIPTION	BLADE WIDTH
50-4253	Four-Prong, Blunt	2¼ in 57 mm



Retractors (Vein Holder)

Parker Retractors

CODE	DESCRIPTION	HANDLE	BLADE WIDTH	
22-1418	Set of 2	Standard Handle	7 in	178 mm
50-4090	Small	Ring Grip Handle	$\frac{5}{8}$ in	16 mm
50-4091	Long	Standard Handle	1 in	25 mm



50-4091

Richardson-Eastman Retractor

CODE	DESCRIPTION	BLADE WIDTH	
50-4135C	Small, Double-Ended, Set of Two	10 in	254 mm



50-4135C

Richardson Retractor

CODE	DESCRIPTION	SIZE	BLADE WIDTH		LENGTH	
50-4120	Standard Handle	Small	$\frac{3}{4}$ in	19 mm	$9\frac{1}{4}$ in	235 mm
50-4121	Standard Handle	Medium	1 in	25 mm	$9\frac{1}{4}$ in	235 mm
50-4122	Standard Handle	Large	$1\frac{1}{2}$ in	38 mm	$9\frac{1}{2}$ in	241 mm
50-4123C	Ring-Grip Handle	Small	$\frac{3}{4}$ in	19 mm	$9\frac{1}{2}$ in	241 mm
50-4124C	Ring-Grip Handle	Medium	1 in	25 mm	$9\frac{1}{2}$ in	241 mm
50-4125C	Ring-Grip Handle	Large	$1\frac{1}{2}$ in	38 mm	$9\frac{1}{2}$ in	241 mm

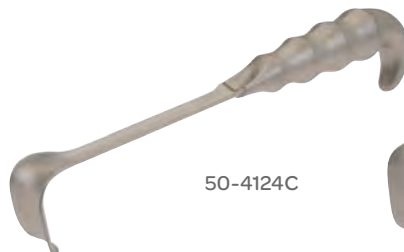

50-4124C



50-4122

Retractors (Vein Holder)

Senn Retractor

CODE	DESCRIPTION	PRONG WIDTH	LENGTH
20-0509	Blunt, Double-Ended, Three Prong		6¼ in 159 mm
20-0508	Sharp, Double-Ended, Three Prong		6¼ in 159 mm
50-4261	Blunt, Double-Ended, Three Prong	5/16 in 8.0 mm	67/8 in 175 mm
50-4260	Sharp, Double-Ended, Three Prong	5/16 in 8.0 mm	67/8 in 175 mm



20-0508

US Army Retractors

CODE	DESCRIPTION	WIDTH	SIZE
50-4071	Set of 2, Double-Ended	8 5/16 in 211 mm	1 3/4 in x 9/16 in 44 x 14 mm



Volkman Retractor

CODE	DESCRIPTION	PRONGS	BLADE LENGTH	BLADE WIDTH
50-4225CO	2-Prong Blunt	3 x 4 Prongs, Blunt	8 3/4 in 222 mm	7/16 in 11 mm
50-4220CO	2-Prong Sharp	3 x 4 Prongs, Blunt	8 3/4 in 222 mm	7/16 in 11 mm
50-4226CO	3-Prong Blunt	3 x 4 Prongs, Blunt	8 3/4 in 222 mm	1 1/16 in 27 mm
50-4221CO	3-Prong Sharp	3 x 4 Prongs, Blunt	8 3/4 in 222 mm	1 1/16 in 27 mm
504227CO	4-Prong Blunt	3 x 4 Prongs, Sharp	8 3/4 in 222 mm	1 5/16 in 33 mm
504222CO	4-Prong Sharp	3 x 4 Prongs, Sharp	8 3/4 in 222 mm	1 5/16 in 33 mm
50-4228CO	6-Prong Blunt	3 x 4 Prongs, Sharp	8 3/4 in 222 mm	1 1/2 in 38 mm
50-4223CO	6-Prong Sharp	3 x 4 Prongs, Sharp	8 3/4 in 222 mm	1 1/2 in 38 mm



50-4225CO

Retractors (Vision)

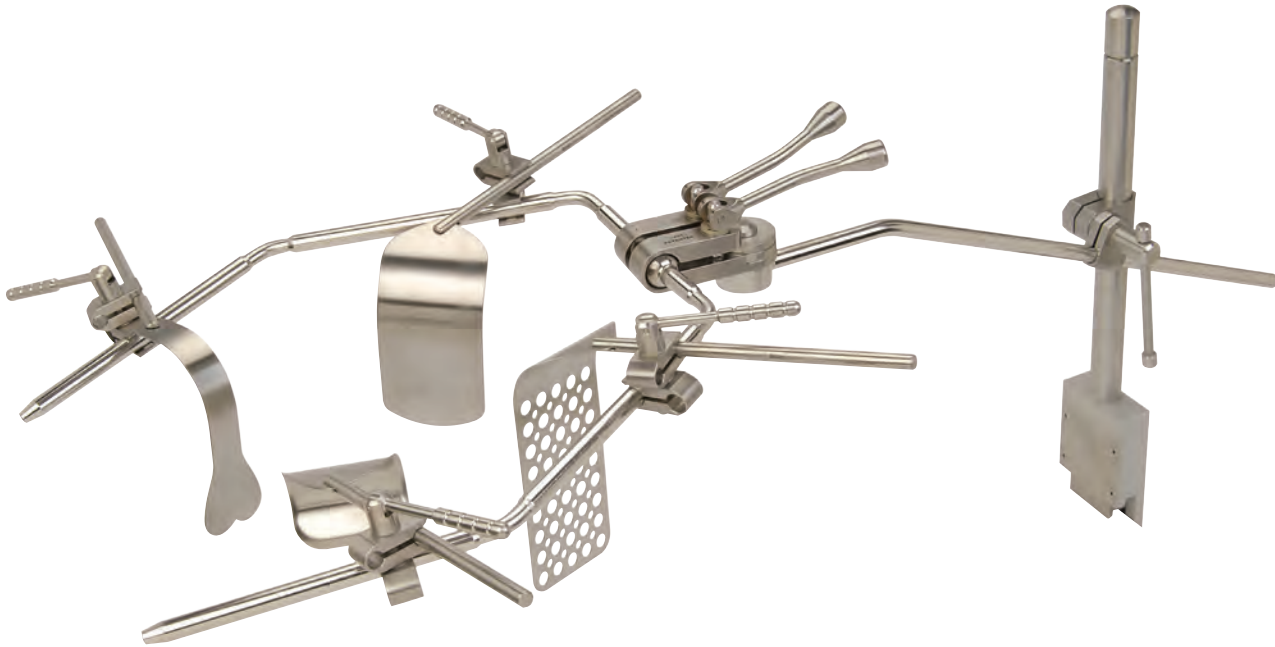

Vision Retractor System

CODE	DESCRIPTION	DIMENSIONS		QTY
59-8850	Vision General System, Include The Following Items:			
59-8802	Table Clamp with Vertical Post			1
59-8803	Retractor Clamp			6
59-8805	Vision Frame			1
59-8807	Mayo Swivel	2 3/4 x 2 in	70 x 51 mm	2
59-8809	Deaver Swivel	2 3/4 x 4 1/2 in	70 x 114 mm	1
59-8811	Harrington "Sweetheart"	2 x 5 in	50 x 127 mm	1
59-8813	Kelly Swivel "Modified"	3 x 2 1/2 in	76 x 64 mm	1
59-8814	Kelly Swivel "Modified"	3 x 4 in	76 x 102 mm	1
59-8815	Malleable Swivel, Perforated	3 x 6 in	76 x 152 mm	1
59-8816	Malleable Swivel, Perforated	3 x 6 1/2 in	76 x 165 mm	1
59-8818	Fence Swivel, Perforated	4 x 6 in	102 x 152 mm	1
59-8821	Splanchnic Swivel	2 x 6 in	51 x 152 mm	1
59-8828	Sterilization Case			1

Note: Individual components are available, in single quantities, by referencing their unique product code upon ordering.

Retractors (Vision)

Vision Retractor System

CODE	DESCRIPTION	DIMENSIONS		QTY
59-8855	Vision General Expanded System Include The Following Items:			
59-8802	Table Clamp with Vertical Post			1
59-8803	Retractor Clamp			8
59-8804	Extension Arm, Hinged			1
59-8805	Vision Frame			1
59-8807	Mayo Swivel	2 ¾ x 2 in	70 x 51 mm	2
59-8809	Deaver Swivel	2 ¾ x 4 ½ in	70 x 114 mm	1
59-8811	Harrington "Sweetheart"	2 x 5 in	51 x 127 mm	1
59-8813	Kelly Swivel "Modified"	3 x 2 ½ in	76 x 64 mm	1
59-8814	Kelly Swivel "Modified"	3 x 4 in	76 x 102 mm	1
59-8815	Malleable Swivel, Perforated	3 x 6 in	76 x 152 mm	1
59-8816	Malleable Swivel, Perforated	3 x 6 ½ in	76 x 165 mm	1
59-8818	Fence Swivel, Perforated	4 x 6 in	102 x 152 mm	1
59-8821	Splanchnic Swivel	2 x 6 in	51 x 152 mm	1
59-8828	Sterilization Case			1

Note: Individual components are available, in single quantities, by referencing their unique product code upon ordering.

Complete Vision Vascular System

CODE	DESCRIPTION	DIMENSIONS		QTY
59-8860	Complete Vision Vascular System, Include The Following Items:			
59-8802	Table Clamp w/ Vertical Post			1
59-8803	Retractor Clamp			8
59-8805	Vision Frame			1
59-8807	Mayo Swivel	2 ¾ x 2 in	70 x 51 mm	2
59-8808	Mayo Swivel	3 ½ x 2 in	89 x 51 mm	1
59-8809	Deaver Swivel	2 ¾ x 4 ½ in	70 x 114 mm	1
59-8811	Harrington "Sweetheart"	2 x 5 in	51 x 127 mm	1
59-8815	Malleable Swivel, Perforated	3 x 6 in	76 x 152 mm	1
59-8816	Malleable Swivel, Perforated	3 x 6 ½ in	76 x 165 mm	1
59-8818	Fence Swivel, Perforated	4 x 6 in	102 x 152 mm	1
59-8820	Splanchnic Swivel	2 x 6 in	51 x 152 mm	1
59-8821	Splanchnic Swivel	2 x 6 in	51 x 152 mm	1
59-8824	Renal Swivel			2
59-8828	Sterilization Case			1

Note: Individual components are available, in single quantities, by referencing their unique product code upon ordering.

Retractors (Vision)

Complete Expanded Vision Vascular System

CODE	DESCRIPTION	DIMENSIONS		QTY
59-8865	Vision Vascular Expanded System, Includes The Following Items			
59-8802	Table Clamp w/ Vertical Post			1
59-8803	Retractor Clamp			10
59-8804	Extension Arm, Hinged			1
59-8805	Vision Frame			1
59-8807	Mayo Swivel	2 ¾ x 2 in	70 x 51 mm	2
59-8808	Mayo Swivel	3 ½ x 2 in	89 x 51 mm	1
59-8809	Deaver Swivel	2 ¾ x 4 ½ in	70 x 114 mm	1
59-8811	Harrington "Sweetheart"	2 x 5 in	51 x 127 mm	1
59-8815	Malleable Swivel, Perforated	3 x 6 in	76 x 152 mm	1
59-8816	Malleable Swivel, Perforated	3 x 6 ½ in	76 x 165 mm	1
59-8818	Fence Swivel, Perforated	4 x 6 in	102 x 152 mm	1
59-8820	Splanchnic Swivel	2 x 6 in	51 x 152 mm	1
59-8821	Splanchnic Swivel	2 x 6 in	51 x 152 mm	1
59-8824	Renal Swivel			2
59-8828	Sterilization Case			1

Note: Individual components are available, in single quantities, by referencing their unique product code upon ordering.

Rib Spreaders

Neonatal Rib Spreader

CODE	DESCRIPTION	BLADE (W X L)		SPREAD	ARM LENGTH
54-1000	Neonatal Rib Spreader	¼ x ¼ in	6.0 x 6.0 mm	1 ⅝ in 41mm	1 in 25mm



Rongeurs (Aortic)

Bailey Aortic Rongeur

CODE	DESCRIPTION	BITE	LENGTH
55-8011	Straight	3.0 mm	4¼ in 108 mm



Rongeurs (Bone Cutting Forceps)

Liston Bone Cutting Rongeur

CODE	DESCRIPTION	LENGTH
30-1310	Straight	5½ in 140 mm



Ruskin Bone Rongeur

Double Action

CODE	DESCRIPTION	JAWS WIDTH	LENGTH
31-0605	Straight	5.0 mm	7⅛ in 181 mm
31-0625	Straight	5.0 mm	9½ in 241 mm
31-0705	Curved	5.0 mm	7⅛ in 181 mm
31-0725	Curved	5.0 mm	9½ in 241 mm



Stille-Luer Rongeur

CODE	DESCRIPTION	JAWS	LENGTH
31-3027	Straight, Double Action	17 mm	10½ in 267 mm
31-3023	Straight, Double Action	10 mm	9 in 229 mm
53-1133	Angular	5.0 mm Bite	9½ in 241 mm
53-1118	Angular, Flat Lower Jaw	5.0 mm Bite	9½ in 241 mm
31-3123	Curved, Double Action	10 mm	9 in 229 mm



Rongeurs (First Rib Rongeur)

Stille Duckbill Bone Rongeur

CODE	DESCRIPTION	JAWS WIDTH	LENGTH
31-3183	Double Action, Angled to Side	7.0 mm	9 in 229 mm



Rongeurs (Duckbill Bone Rongeur)

Dale First Rib Rongeur

CODE	DESCRIPTION	BITE	LENGTH
56-8040	Double Action	1/8 in 3.0 mm	14 1/2 in 368 mm



Saws

Sternum Saw

CODE	DESCRIPTION	
26-7006	Sternum Saw	Air Powered, Handpiece w/Footplate
26-7010	Sternum Saw Blades	Sterile Disposable, 5 Per Package
26-7004	Sternum Saw Footplate	
26-7005	Sternum Saw Set	Includes (Below) Air Powered
26-7003	Sternum Saw Set Sterilizing Case	



26-7010



26-7006

Scissors (Artery)

Church Artery Scissors

CODE	DESCRIPTION	LENGTH
04-7527	Curved	7 in 178 mm
04-7427	Straight	7 in 178 mm



04-7527

Scissors (Bandage)

Classic® Lister Bandage Scissors

CODE	DESCRIPTION	LENGTH
34-4013	Straight	7½ in 191 mm



Lister Bandage Scissors

CODE	DESCRIPTION	BLADE SIZE
54-4012	Equal sized rings	5¾ in 146 mm
54-4013	Equal sized rings	7½ in 191 mm
54-4192	One Large Ring	7¼ in 184 mm



54-4192

Scissors (Calcified Tissue)

Calcified Tissue Scissors

CODE	DESCRIPTION	BLADE SIZE
54-8024	Curved, Serrated Blades	9 in 229 mm



Scissors (Cardiovascular)

Cooley Cardiovascular Scissors "My Scissors"

CODE	DESCRIPTION	HANDLES	BLADE SIZE
55-1350	Curved on Flat		7½ in 191 mm
55-1350L	Curved on Flat	Left Handed	7½ in 191 mm
37-4036	Curved on Flat	Mayo Type Handles	7½ in 191 mm
55-1351	Curved on Flat		9 in 229 mm



37-4036

Scissors (Circumflex)

Beall Circumflex Scissors

CODE	DESCRIPTION	LENGTH
55-1108	Circumflex Scissors	6 in 152 mm

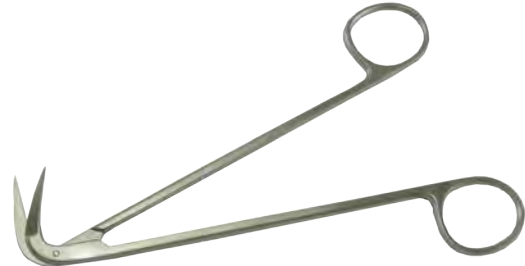

Scissors (Coronary)

Favaloro Coronary Scissors

CODE	DESCRIPTION	ANGLE	BLADE (W X L)	LENGTH
54-8010	Curved Shank	130°	1/8 x 7/16 in 3.0 x 11 mm	6 3/4 in 171 mm
55-8085		130°	1/8 x 7/16 in 3.0 x 11 mm	6 3/4 in 171 mm

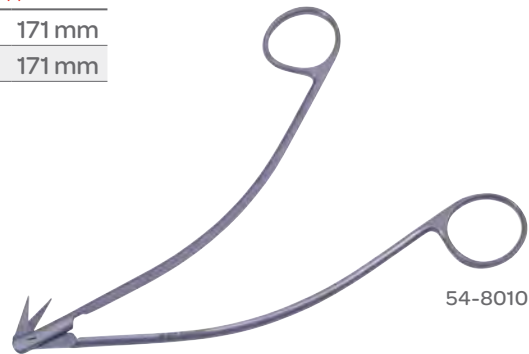

Scissors (Coronary Artery)

Diethrich Coronary Artery Scissors

CODE	ANGLE	LENGTH
54-8017	Angled 25°	7 in 178 mm
55-1001	Angled 25°	7 in 178 mm
54-8018	Angled 45°	7 in 178 mm
54-8019	Angled 60°	7 in 178 mm
54-8021	Angled 90°	7 in 178 mm
54-8020	Angled 125°, With Stabilizing Bar	7 in 178 mm
55-1002	Angled 45°	7 1/4 in 184 mm
55-1026	Angled 25°	8 1/2 in 216 mm
55-1027	Angled 45°	8 1/2 in 216 mm
55-1028	Angled 60°	8 1/2 in 216 mm
55-1029	Angled 90°	8 1/2 in 215 mm

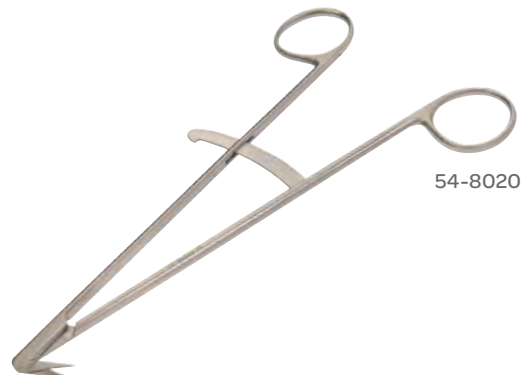

Scissors (Coronary Artery)

Coronary Artery Scissors

CODE	DESCRIPTION	LENGTH	
54-8070	Angled 25°	7 in	178 mm
55-8071	Angled 45°	7 in	178 mm
55-8072	Angled 60°	7 in	178 mm
54-8073	Angled 90°	7 in	178 mm
54-8074	Angled 105°	7 in	178 mm
54-8075	Angled 125°, with Stabilizer Bar	7 in	178 mm

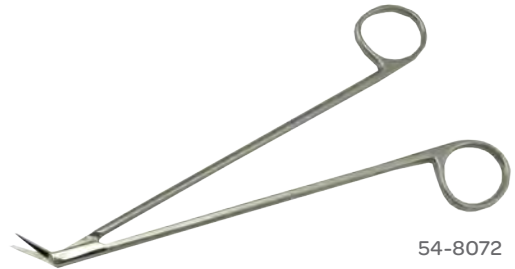

54-8072

Coronary Artery Scissors

Ball Tip

CODE	DESCRIPTION	LENGTH	
55-8501	Angled 25°	6 3/4 in	171 mm
55-8502	Angled 45°	6 3/4 in	171 mm
55-8503	Angled 60°	6 3/4 in	171 mm
55-8504	Angled 90°	6 3/4 in	171 mm
55-8505	Angled 120°	6 3/4 in	171 mm



55-8501

Coronary Artery Scissors

Flat Handle

CODE	DESCRIPTION	LENGTH	
55-8601	Angled 25°	6 3/4 in	171 mm
55-8602	Angled 45°	6 3/4 in	171 mm
55-8603	Angled 60°	6 3/4 in	171 mm
55-8604	Angled 90°	6 3/4 in	171 mm
55-8605	Angled 120°	6 3/4 in	171 mm



55-8601

Reul Coronary Artery Scissors

CODE	ANGLE	BLADE (W X L)	LENGTH	
54-8011	45°	1/4 x 1 3/16 in	6.0 x 30 mm	7 1/4 in 184 mm
54-8014	60°	1/8 x 7/8 in	3.0 x 22 mm	7 1/4 in 184 mm



54-8014

Scissors (Delicate)

Delicate Scissors

CODE	DESCRIPTION	LENGTH
54-2515	Blunt, Straight	4 ½ in 114 mm
54-2520	Blunt/Blunt, Curved	4 ½ in 114 mm
54-5567	Curved with Dissecting End	4 7/8 in 124 mm



54-2515

Scissors (Dissecting)

Classic® Mayo Scissors

CODE	DESCRIPTION	LENGTH
34-4098	Straight, Beveled Blades	5 ½ in 140 mm
34-4490	Straight, Beveled Blades	6 ¾ in 171 mm
34-4092	Straight, Rounded Blades	6 ¾ in 171 mm
34-4088	Straight, Rounded Blades	5 ½ in 140 mm
34-4095	Curved, Beveled Blades	6 ¾ in 171 mm
34-4097	Curved, Round Blades	6 ¾ in 171 mm



34-4095

Classic® Metzenbaum Scissors

CODE	DESCRIPTION	LENGTH
34-1020	Blunt/Blunt, Straight	5 ¾ in 146 mm
34-1021	Blunt/Blunt, Curved	5 ¾ in 146 mm
34-1027	Blunt/Blunt, Curved	7 in 178 mm



34-1027

Scissors (Dissecting)

DeBakey-Metzenbaum Scissors

Tungsten Carbide Edges

CODE	DESCRIPTION	LENGTH
32-3576	Straight	12¼ in 311 mm



Delicate Dissecting Scissors

CODE	DESCRIPTION	LENGTH
54-5566	Curved	5 in 127 mm



Delicate Lahey Scissors

CODE	DESCRIPTION	LENGTH
54-5571	Curved	5¾ in 146 mm



Delicate Metzenbaum Scissors

CODE	DESCRIPTION	LENGTH
54-5573	Curved	7 in 178 mm



Doyen Abdominal Scissors

CODE	DESCRIPTION	LENGTH
54-4080	Straight	7 in 178 mm



Scissors (Dissecting)

Fergusson Abdominal Scissors

CODE	DESCRIPTION	LENGTH
54-4085	Angled on Flat	7¼ in 184 mm



Jacobson Scissors

CODE	DESCRIPTION	LENGTH
55-8088	Angled, Sharp	6¾ in 171 mm



Jorgenson Dissecting Scissor

CODE	DESCRIPTION	LENGTH
54-4151	Strong Curve	8½ in 216 mm
54-4023	Strong Curve	9 in 229 mm
54-4080S	Strong Curve	14 in 356 mm



54-4151

Lincoln Scissors

Rounded Blades

CODE	DESCRIPTION	LENGTH
55-2270	Straight	7 in 178 mm
55-2280	Curved	7 in 178 mm

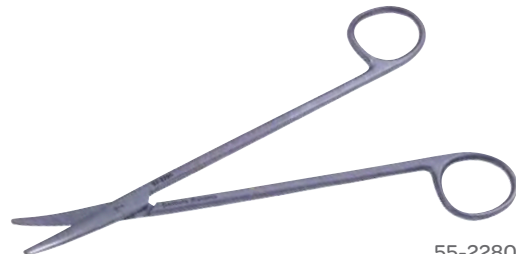

55-2280

Scissors (Dissecting)

Mayo Dissecting Scissors

CODE	DESCRIPTION	LENGTH	
54-4098	Straight, Beveled Blades	5½ in	140 mm
54-4090	Straight, Beveled Blades	6¾ in	171 mm
54-5535	Straight, Beveled Blades	9 in	229 mm
54-4088	Straight, Round Blades	5¾ in	146 mm
54-4099	Curved, Beveled Blades	5½ in	140 mm
54-4095	Curved, Beveled Blades	6¾ in	171 mm
54-4105	Curved, Beveled Blades	9 in	229 mm
54-4097	Curved, Round Blades	6¾ in	171 mm



54-4090

Mayo Dissecting Scissors

Dissecting Scissors, Stellite Edge Inserts

CODE	DESCRIPTION	LENGTH	
54-4092	Straight, Round Blades	6¾ in	171 mm
36-5060	Curved	5½ in	140 mm
36-5061	Curved	6¾ in	171 mm
36-5062	Curved	9 in	229 mm



54-4092

Mayo Scissors

Dissecting Scissors, Stellite Edge Inserts

CODE	DESCRIPTION	LENGTH	
36-5050	Straight	5½ in	140 mm
36-5051	Straight	6¾ in	171 mm
36-5052	Straight	9 in	229 mm



36-5050

Mayo-Harrington Dissecting Scissors

CODE	DESCRIPTION	LENGTH	
32-3592	Straight	14 in	356 mm
03-5323	Curved, Slender Pattern	9 in	229 mm
32-3593	Curved	14 in	356 mm
32-3585	Curved	14 in	356 mm



32-3592

Scissors (Dissecting)

Mayo-Noble Scissors

Dissecting Scissors, Beveled Blades

CODE	DESCRIPTION	LENGTH
54-4075	Straight	6 ¼ in 159 mm
54-4076	Curved	6 ¼ in 159 mm



54-4076

Metzenbaum Classic Plus® Dissecting Scissors

Straight, Delicate Stellite Edge Inserts

CODE	DESCRIPTION	LENGTH
36-5021	Blunt/Blunt	5 ¾ in 146 mm
36-5023	Blunt/Blunt	7 in 178 mm
36-5025	Blunt/Blunt	9 in 229 mm
36-5020	Sharp/Sharp	5 ¾ in 146 mm
36-5022	Sharp/Sharp	7 in 178 mm
36-5024	Sharp/Sharp	9 in 229 mm



36-5020

Metzenbaum Classic Plus® Dissecting Scissors

Curved, Delicate Stellite Edge Inserts

CODE	DESCRIPTION	LENGTH
36-5031	Blunt/Blunt	5 ¾ in 146 mm
36-5033	Blunt/Blunt	7 in 178 mm
36-5035	Blunt/Blunt	9 in 229 mm
36-5030	Sharp/Sharp	5 ¾ in 146 mm
36-5032	Sharp/Sharp	7 in 178 mm
36-5034	Sharp/Sharp	9 in 229 mm



36-5031

Metzenbaum Classic Plus® Dissecting Scissors

Standard, Stellite Edge Inserts

CODE	DESCRIPTION	LENGTH
36-5010	Straight	5 ¾ in 146 mm
36-5011	Straight	7 in 178 mm
36-5015	Curved	5 ¾ in 146 mm
36-5016	Curved	7 in 178 mm
36-5017	Curved	9 in 229 mm



36-5010

Scissors (Dissecting)

Metzenbaum Dissecting Scissors

CODE	DESCRIPTION	LENGTH
54-1023	Curved	5 in 127 mm
54-1021	Curved	5 ¾ in 146 mm
54-1027	Curved	7 in 178 mm
54-1030	Curved	8 in 203 mm
54-1034	Curved	9 in 229 mm
54-1037	Curved	10 in 254 mm
32-3594	Curved	12 ¼ in 311 mm
32-3595	Curved	13 ⅞ in 352 mm
32-3596	Curved, Super Cut	13 ⅞ in 352 mm



54-1021

Thoracoscopy Metzenbaum Dissecting Scissors

CODE	DESCRIPTION	LENGTH
54-1020	Straight	5 ¾ in 146 mm
54-1026	Straight	7 in 178 mm
54-0009	Non-Locking	8 ¼ in 210 mm



54-1020

Nelson Scissors

CODE	DESCRIPTION	LENGTH
54-8025	Straight	9 in 229 mm



Potts-Smith Dissecting Scissors

Rounded Tips, Saber Back Blades

CODE	DESCRIPTION	LENGTH
55-1317	Curved	5 ½ in 140 mm
55-1318	Curved	7 ¼ in 184 mm
55-1319	Curved	9 in 229 mm
55-1320	Curved	11 ¼ in 286 mm



55-1318

Scissors (Endarterectomy)

DeBakey Endarterectomy Scissors

CODE	LENGTH
54-8012	7 in 178 mm



Endarterectomy Scissors

CODE	DESCRIPTION	LENGTH
85-1355	Curved, Serrated	6 3/4 in 171 mm



Ultra™ Endarterectomy Scissors

CODE	DESCRIPTION	LENGTH
55-1374	Slightly Curved	7 in 178 mm



Scissors

Scissors

Titanium, Serrated Jaws

CODE	DESCRIPTION	LENGTH
80-6008	Straight, Fine Tip	6 in 152 mm
80-6009	Straight, Regular Tip	6 in 152 mm



80-6009

Scissors

Titanium, Extra Fine

CODE	DESCRIPTION	LENGTH
80-6640	Straight	6 in 152 mm
80-6641	Curved	6 in 152 mm
80-6642	60° Angle, Straight Blade	6 in 152 mm



80-6640

Scissors (Fine)

Fine Scissors

CODE	DESCRIPTION	LENGTH
54-1075	Straight, Sharp/Sharp	4½ in 114 mm
54-1076	Curved, Sharp/Sharp	4½ in 114 mm



54-1075

Scissors (Fine Vascular)

Fine Vascular Scissors

CODE	DESCRIPTION	WIDTH	LENGTH
54-8008	Angled 45°	3/16 x 1/2 in	5.0 x 13 mm 5¼ in 133 mm



Scissors (I.M.A.)

I.M.A. Scissors

Titanium

CODE	DESCRIPTION	LENGTH
80-1854	Straight, 45° Tip	6 in 152 mm
80-1855	Bayonet, 45° Tip	7½ in 191 mm
80-1856	Bayonet, Reverse Angle	7½ in 191 mm



80-1854

80-1855

80-1856

Scissors (Leaflet)

Valve Leaflet Scissors

CODE	DESCRIPTION	LENGTH
55-9089	Blades Angled on Flat 45°	5½ in 140 mm



Scissors (Lobectomy)

Crafoord Lobectomy Scissors

CODE	DESCRIPTION	LENGTH
55-8012	Curved, Blunt Tips	12 in 305 mm



Scissors (MagnaFree®)

MagnaFree® MRI Mayo Scissors

CODE	DESCRIPTION	LENGTH
65-2416	Non-Magnetic, Titanium, for Intraoperative MRI	6¾ in 171 mm



Scissors (Micro)

Double Action Micro Scissors

CODE	DESCRIPTION	LENGTH
55-8700	Straight Blades	7¼ in 184 mm
55-8705	Curved Blades	7¼ in 184 mm



55-8705

Scissors (Micro)

Jacobson Micro Scissors

Angled on Flat

CODE	DESCRIPTION	LENGTH	
55-8710	Angled 25°	7 in	178 mm
55-8711	Angled 45°	7 in	178 mm
55-8712	Angled 60°	7 in	178 mm



55-8710

Micro Scissors

CODE	DESCRIPTION	LENGTH	
80-2005	Straight Tip	5½ in	140 mm
80-2006	Curved Tip	5½ in	140 mm



80-2006

Scissors (Micro Vascular)

Feather Lite Micro Vascular Scissors

CODE	DESCRIPTION	LENGTH	
55-8059FL	45°	7 in	178 mm



Ceramic Coated Micro Vascular Scissors

CODE	DESCRIPTION	LENGTH	
84-8160	25°	7 in	178 mm
84-8059	45°	7 in	178 mm
84-8062	120°	7 in	178 mm



84-8160

Scissors (Microsurgical)

Decker Microsurgical Scissors

Alligator Action

CODE	DESCRIPTION	LENGTH
54-5604	Straight	5½ in 140 mm
54-5605	Curved Left	5½ in 140 mm
54-5606	Curved Right	5½ in 140 mm



Scissors (Mitral Valve)

Litwak Mitral Valve Scissors

CODE	DESCRIPTION	LENGTH
54-8023	Angled on Side	11 in 279 mm

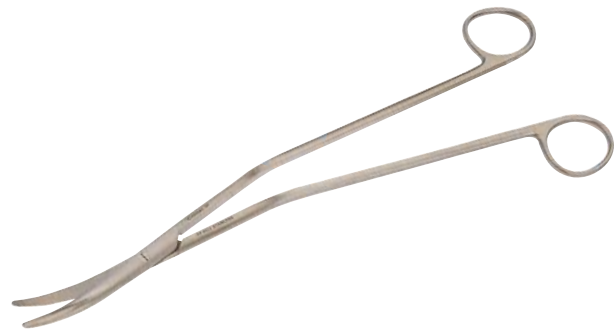

Scissors (Modified Circumflex)

Lawrie Modified Circumflex Scissors

Without Stabilizing Bar

CODE	DESCRIPTION	BLADE (W X L)	LENGTH
54-8016	130°	⅛ x ½ in 3.0 x 13 mm	7 in 178 mm

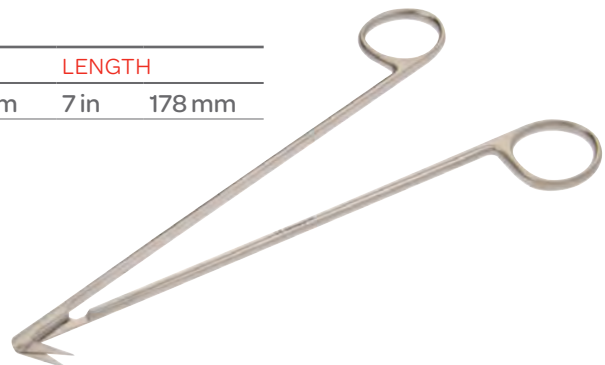

Scissors (Operating)

Classic Plus® Operating Scissors

Stellite Edge Inserts, Straight, Sharp

CODE	DESCRIPTION	LENGTH
36-5040	Sharp/Blunt	5½ in 140 mm
36-5041	Sharp/Sharp	5½ in 140 mm



Deaver Operating Scissors

CODE	DESCRIPTION	LENGTH
54-4066	Straight, Sharp/Blunt	5½ in 140 mm



Delicate Operating Scissors

Straight

CODE	DESCRIPTION	LENGTH
54-4301	Sharp/Sharp	5 in 127 mm
54-4300	Sharp/Blunt	5 in 127 mm
54-4306	Sharp/Blunt	5½ in 140 mm



Mixer Operating Scissors

CODE	DESCRIPTION	LENGTH
54-1010	Straight, Blunt/Blunt	6 in 152 mm



Scissors (Operating)

Operating Scissors

Straight

CODE	DESCRIPTION	LENGTH	
54-4027	Sharp/Sharp	5 in	127 mm
54-4030	Sharp/Sharp	5½ in	140 mm
54-4026	Sharp/Blunt	5 in	127 mm
54-4029	Sharp/Blunt	5½ in	140 mm
54-4032	Sharp/Blunt	6 in	152 mm
54-4035	Sharp/Blunt	6½ in	165 mm
54-4028	Blunt, Blunt	5½ in	140 mm
54-4034	Blunt, Blunt	6½ in	165 mm



54-4027

Scissors (Razor)

DeBakey Razor Scissors

Without Serrations, Razor Edge

CODE	DESCRIPTION	HANDLES	LENGTH	
80-1043	45°	Black	11 in	279 mm



Scissors (Razor Micro)

Diethrich Potts Razor Micro Scissors

Without Serrations, Razor Edge

CODE	DESCRIPTION	HANDLE	LENGTH	
80-1543F	45°	Black	7 in	178 mm

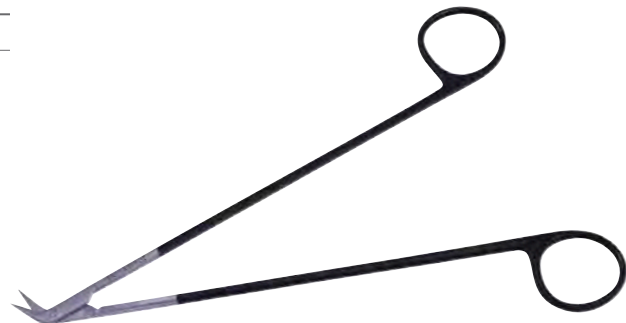

Scissors (Stitch)

Littauer Stitch Scissors

CODE	DESCRIPTION	LENGTH
54-4017	Stitch Scissors	5½ in 140 mm



Shortbent Stitch Scissors

CODE	DESCRIPTION	LENGTH
54-2555	Curved on Side Razor Edge	3½ in 89 mm



Spencer Stitch Scissors

CODE	DESCRIPTION	LENGTH
54-6624	Stitch Scissors	3½ in 89 mm
54-4205	Stitch Scissors	4½ in 114 mm



54-6624

Wescott Stitch Scissors

CODE	DESCRIPTION	LENGTH
54-6630	Sharp/Sharp	4¼ in 108 mm



Scissors (Stitch)

New Suture Scissors

CODE	DESCRIPTION	LENGTH
54-2550	Angled on Side	5½ in 140 mm



Scissors (Suture)

Wire Classic Plus® Suture Scissors

CODE	DESCRIPTION	LENGTH
36-5080	Stellite Edge Inserts, Angled	4¾ in 121 mm



Scissors (Thoracic Scissor)

Thorek Thoracic Scissors

CODE	DESCRIPTION	LENGTH
51-2519	Strong Curve, Rounded Blades	7½ in 191 mm
51-2523	Strong Curve, Rounded Blades	10 in 254 mm



51-2519

Scissors (Valve)

Diethrich Valve Scissors

Serrated Blades

CODE	DESCRIPTION	LENGTH	
54-8006	Full Curve	9 in	229 mm
54-8005	Slight Curve	9 in	229 mm
67-7665	Dissecting	12 in	305 mm



54-8005

Thompson Valve Scissors

CODE	DESCRIPTION	LENGTH	
55-8814	Full Curve	10 in	254 mm

Scissors (Vascular)

Classic® Fine Scissors

CODE	DESCRIPTION	LENGTH	
34-1076	Curved	4 ½ in	114 mm



Nelson Classic Plus® Scissors

Stellite Edge Inserts, Curved

CODE	DESCRIPTION	LENGTH	
36-5070	Standard	11 in	279 mm
36-5071	Delicate	11 in	279 mm



36-5070

Scissors (Vascular)

Arteriotomy Scissors

Flat Handle

CODE	DESCRIPTION	LENGTH
55-9090	Angled 45°	5 ¼ in 133 mm



Church Vascular Scissors

CODE	DESCRIPTION	LENGTH
04-7526	Curved	10 5/8 in 270 mm

DeBakey-Potts-Smith Vascular Scissors

Rounded Tips

CODE	DESCRIPTION	LENGTH
55-1512	Angled 25°	9 in 229 mm
55-1514	Angled 45°	9 in 229 mm
55-1526	Angled 60°	11 in 279 mm

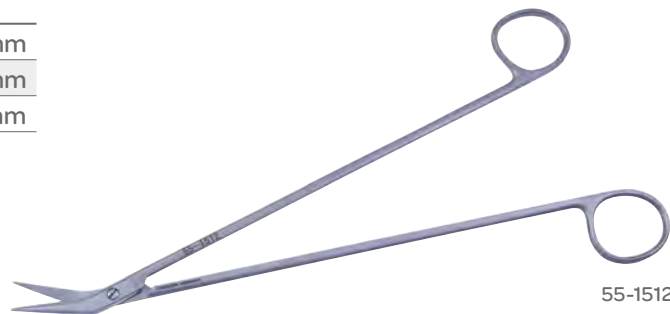

55-1512

DeBakey Scissors

CODE	ANGLE	BLADE (W X L)	LENGTH
54-8035	25°	3/16 x 7/8 in 5.0 x 22 mm	6 ½ in 165 mm
54-8036	45°	3/16 x 7/8 in 5.0 x 22 mm	6 ½ in 165 mm
54-8037	60°	3/16 x 7/8 in 5.0 x 22 mm	6 ½ in 165 mm



54-8035

Scissors (Vascular)

Demartel Scissors

CODE	DESCRIPTION	LENGTH	
04-7018	Straight, Sharp/Sharp	6 ³ / ₄ in	171 mm
04-7118	Curved, Sharp/Sharp	6 ³ / ₄ in	171 mm
04-7119	Curved, Blunt/Blunt	7 in	178 mm

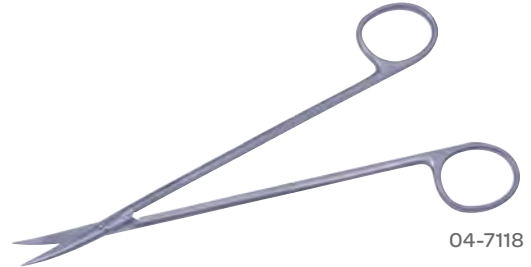

04-7118

Diethrich Potts Scissors

CODE	DESCRIPTION	LENGTH	
55-1540	25° Angled Blades	7 ¹ / ₂ in	191 mm
55-1540F	25° Fine Angled Blades	7 ¹ / ₂ in	191 mm

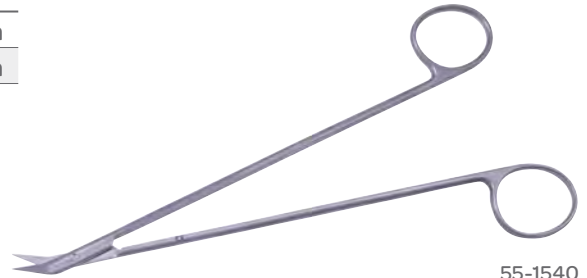

55-1540

Diethrich Scissors

Serrated Blades

CODE	DESCRIPTION	LENGTH	
85-2110	25°	7 in	178 mm
85-2113	90°	7 in	178 mm
85-2114	120°	7 in	178 mm

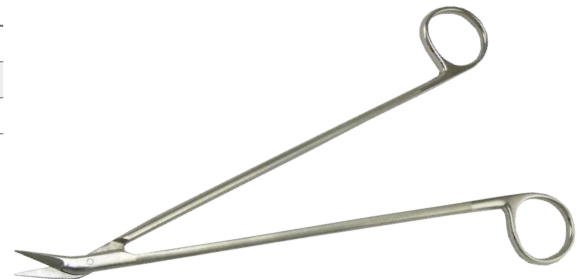

85-2110

Diethrich Scissors

Serrated Blades, Black Handles

CODE	DESCRIPTION	LENGTH	
86-1001	25°	7 in	178 mm
86-1002	45°	7 in	178 mm

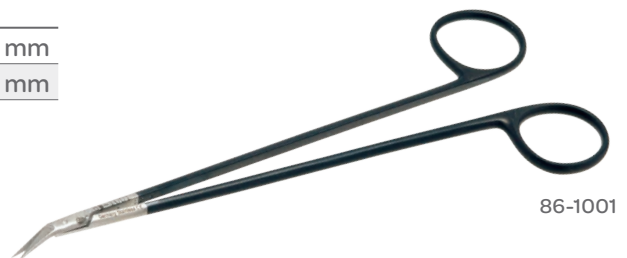

86-1001

Scissors (Vascular)

Diethrich Scissors

Angled, Serrated Lower Blade, Tungsten Carbide Cutting Edges

CODE	DESCRIPTION	LENGTH	
32-844	25°	7 in	178 mm
32-846	60°	7 in	178 mm
32-848	120°	7 in	178 mm

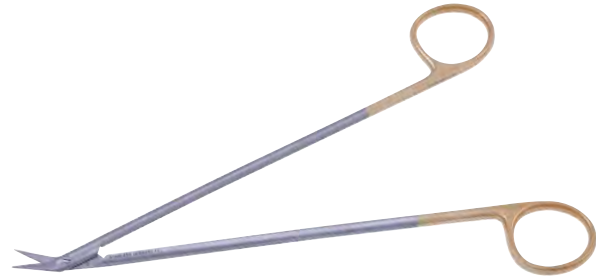

32-844

Duffield Vascular Scissors

CODE	DESCRIPTION	LENGTH	
04-7425	Straight	10 in	254 mm



Hagemann-Diethrich Vascular Scissors

CODE	DESCRIPTION	LENGTH	
55-1531	Angled 45°	5½ in	140 mm
55-1532	Angled 25°	7 in	178 mm
55-1534	Angled 45°	7 in	178 mm
55-1536	Angled 60°	7 in	178 mm
55-1539	Angled 90°	7 in	178 mm

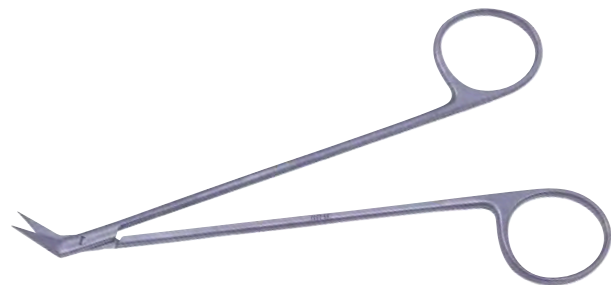

55-1531

Ceramic Coated Diethrich Vascular Scissors

Tungsten Carbide Edges, Ceramic Coating, Razor Edges and Micro Serrations

CODE	DESCRIPTION	LENGTH	
225.15.32	Angled 25°	7¼ in	184 mm
225.15.34	Angled 45°	7⅛ in	181 mm
225.15.36	Angled 60°	7 in	178 mm
225.15.39	Angled 90°	6¾ in	171 mm



225.15.36

Scissors (Vascular)

Ceramic Coated Potts-Smith Scissors

Tungsten Carbide Edges, Ceramic Coating, Razor Edges and Micro Serrations

CODE	DESCRIPTION	LENGTH
225.15.43	Angled 25°	7 ¼ in 184 mm
225.15.44	Angled 45°	7 ¼ in 184 mm
225.15.46	Angled 60°	7 ¼ in 184 mm

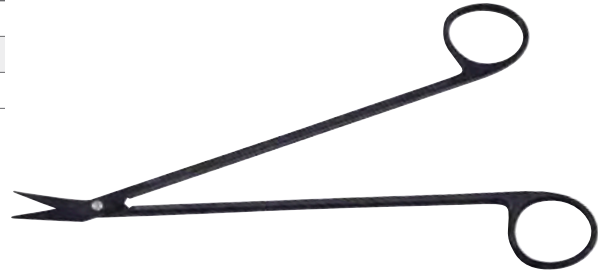

225.15.43

Diethrich Ceramic Coated Vascular Scissors

One Blade with Micro Serrations, Tungsten Carbide Cutting Edges, Black Ceramic Coating

CODE	DESCRIPTION	LENGTH
225.15.40	125°	7 ⅞ in 181 mm



Mattox-Potts Scissors

CODE	DESCRIPTION	BLADE (W X D)	LENGTH
54-8004	45°	¼ x 1 ⅜ in 6.0 x 30 mm	5 ½ in 140 mm



Potts-Smith Scissors

CODE	DESCRIPTION	BLADE (W X D)	LENGTH
54-8002	45°	¼ x 7/8 in 6.0 x 22 mm	7 ½ in 191 mm
54-8003	60°	¼ x 7/8 in 6.0 x 22 mm	7 ½ in 191 mm

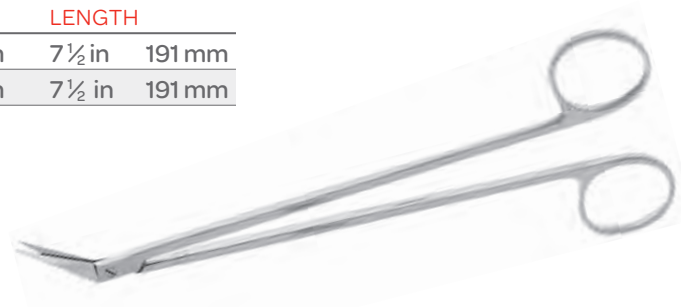

Scissors (Vascular)

Potts-Smith Scissors

Blunt Tips

CODE	DESCRIPTION	LENGTH
55-1032	Angled 25°	7½ in 191 mm
55-1033	Angled 45°	7½ in 191 mm

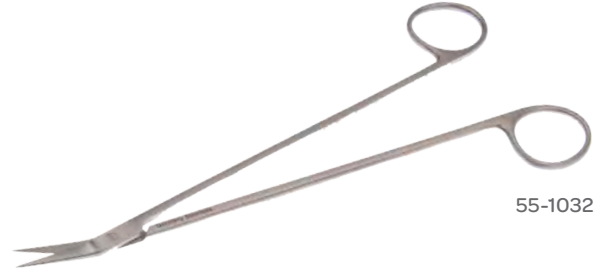

55-1032

Potts-Smith Scissors

Serrated Blades, Black Handles

CODE	DESCRIPTION	LENGTH
86-1032	25°	7 in 178 mm
86-1033	45°	7 in 178 mm
86-1034	60°	7 in 178 mm



86-1034

Potts-Smith Scissors

Serrated Lower Blade, Tungsten Carbide Cutting Edges

CODE	DESCRIPTION	LENGTH
32-685	Angled 45°	7 in 178 mm
32-686	Angled 90°	7 in 178 mm

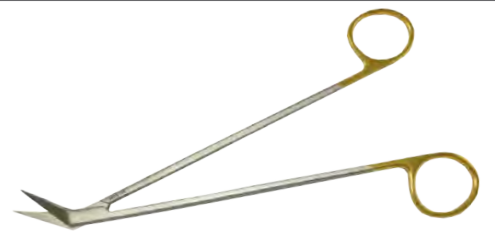

32-685

Potts-Smith Scissors

Serrated Lower Blade, Tungsten Carbide Cutting Edges, Regular Blade, Dissecting

CODE	DESCRIPTION	LENGTH
37-4030	Curved	7½ in 191 mm



Scissors (Vascular)

CVT

Peripheral Vascular Scissors

CODE	ANGLE	BLADES	LENGTH
55-1007	25°	Short Delicate Blades	5 in 127 mm
55-1009	60°	Short Delicate Blades	5 in 127 mm
55-1010	90°	Short Delicate Blades	5¼ in 133 mm
55-1207	25°	With One Serrated Blade	5 in 127 mm
55-1208	45°	With One Serrated Blade	5 in 127 mm
55-1209	60°	With One Serrated Blade	5 in 127 mm
55-1210	90°	With One Serrated Blade	5 in 127 mm



55-1007

Potts-Smith Scissors

Serrated Blades

CODE	ANGLE	DESCRIPTION	LENGTH
86-1032	25°	Black Handles	7 in 178 mm
86-1033	45°	Black Handles	7 in 178 mm
86-1034	60°	Black Handles	7 in 178 mm



86-1034

Potts-Smith Scissors

CODE	ANGLE	BLADE (W X D)	LENGTH
54-8002	45°	¼ x 7/8 in 6.0 x 22 mm	7½ in 191 mm
54-8003	60°	¼ x 7/8 in 6.0 x 22 mm	7½ in 191 mm

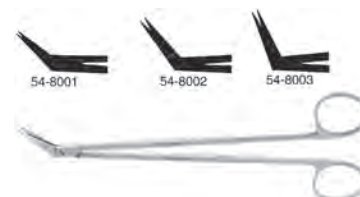

Potts-Smith Scissors

Standard Pattern, Blunt Tips

CODE	DESCRIPTION	LENGTH
55-1032	Angled 25°	7½ in 191 mm
55-1033	Angled 45°	7½ in 191 mm



55-1032

Potts-Smith Scissors

Regular Blade, Dissecting

CODE	DESCRIPTION	LENGTH
37-4030	Curved	7½ in 191 mm



Scissors (Vascular)

Potts-Smith Scissors

With Tungsten Carbide Inserts, Serrated Lower Blade

CODE	ANGLE	LENGTH
32-684	25°	7½ in 191 mm
32-685	45°	7½ in 191 mm
32-686	60°	7½ in 191 mm



32-686

Micro Vascular Scissors

CODE	DESCRIPTION	TIPS	HANDLE	LENGTH
55-8160	Angled 25°	Delicate Tips	Flat	6⅝ in 168 mm
55-8165	Angled 45°	Delicate Tips	Flat	6½ in 165 mm
55-8170	Angled 60°	Delicate Tips	Flat	6¾ in 171 mm
55-8178	Angled 120°	Delicate Tips	Flat	6¼ in 159 mm
55-8062	Angled 120°	Extra Delicate	Round	6¾ in 171 mm
55-8058	Angled 25°	Extra Delicate	Round	7 in 178 mm
55-8059	Angled 45°	Extra Delicate	Round	7 in 178 mm
55-8061	Angled 90°	Extra Delicate	Round	7 in 178 mm
55-8091	Angled 25°	Extra Delicate	Round	8¼ in 210 mm
55-8092	Angled 45°	Extra Delicate	Round	8¼ in 210 mm
55-8094	Angled 90°	Extra Delicate	Round	8¼ in 210 mm
55-8095	Angled 120°	Extra Delicate	Round	8¼ in 210 mm

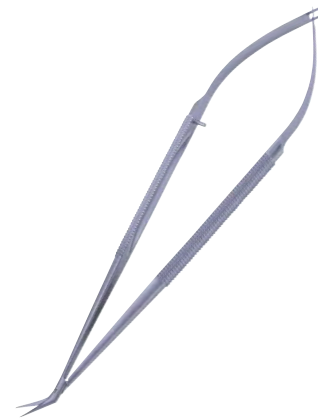

55-8059

“Razor Edge” Diethrich Scissors

Black Handles, Without Serrations, Razor Edge

CODE	DESCRIPTION	LENGTH
80-1001	Angled 25°	7¼ in 184 mm
80-1002	Angled 45°	7¼ in 184 mm
80-1003	Angled 60°	7¼ in 184 mm
80-1005	Angled 120°	7¼ in 184 mm



80-1005

“Razor Edge” Potts-Smith Scissors

Black Handles, Without Serrations, Razor Edge

CODE	DESCRIPTION	LENGTH
80-1032	Angled 25°	7½ in 191 mm
80-1033	Angled 45°	7¼ in 184 mm
80-1034	Angled 60°	7½ in 191 mm

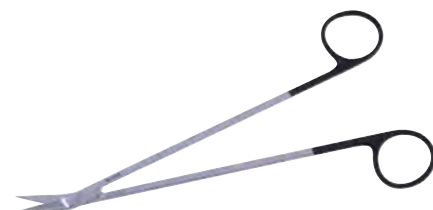

80-1032

Scissors (Vascular)

“Razor Edge” Diethrich Scissors with Gold Screw

One Blade with Micro Serrations, Black Handles, Gold Screw

CODE	DESCRIPTION	LENGTH
255.15.42	Angled 25°	7½ in 191 mm
255.15.44	Angled 45°	7½ in 191 mm
255.15.36	Angled 60°	7½ in 191 mm

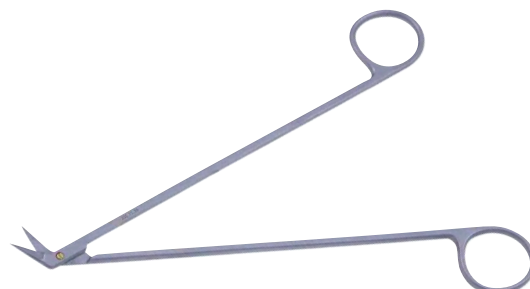

255.15.36

Satinsky Scissors

S-Shaped

CODE	DESCRIPTION	LENGTH
55-1355	Blunt Tips	9¾ in 248 mm

Ultra™ Vascular Scissors

Delicate Blades

CODE	DESCRIPTION	LENGTH
54-8055	Angled 125°	7 in 178 mm
54-8040	Angled 25°	7¼ in 184 mm

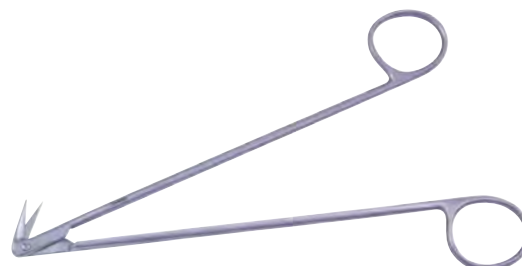

54-8055

Scissors (Wire)

Wire Cutting Suture Scissors

CODE	DESCRIPTION	LENGTH
54-4210	Serrated Blades	4½ in 114 mm



Scissors (Wire)

Wire Suture Scissors

CODE	DESCRIPTION	LENGTH
54-4110	Angled, One Serrated Jaw	4 ³ / ₄ in 121 mm



Shears (Rib Shears)

Bethune Rib Shears

CODE	DESCRIPTION	LENGTH
54-1234	Slightly S-Shaped	13 ³ / ₈ in 340 mm



Gluck Rib Shears

CODE	LENGTH
54-1019	7 ¹ / ₂ in 191 mm



Coryllos Rib Shears

CODE	DESCRIPTION	LENGTH
56-8055	Left	14 in 356 mm
56-8056	Right	14 in 356 mm



56-8055

Shears (Rib Shears)

Giertz Rib Shears

CODE	LENGTH
54-1525	10 in 254 mm



Sauerbruch Rib Shears

CODE	LENGTH
56-8051	10 1/2 in 267 mm



Stille Giertz Rib Shears

CODE	LENGTH
56-8044	10 in 254 mm



Spatulas (Endarterectomy Spatula)

Endarterectomy Spatula

CODE	DESCRIPTION	LENGTH	
55-9210	Spatula	7 in	178 mm



Jacobson Endarterectomy Spatula

Curved Blade, Semi-Sharp Blade

CODE	DESCRIPTION	LENGTH	
55-7056	1.0x10 mm	7 in	178 mm

Spreaders (Pediatric Rib Spreader)

Haight Pediatric Rib Spreader

CODE	DESCRIPTION	SPREAD	
54-2220	Fenestrated Blades	2½ in	64 mm



Spreaders (Rib Spreader)

Burford Finochietto Rib Spreader

CODE	DESCRIPTION	SPREAD		LENGTH	
54-2343	Stainless Steel	10 in	254 mm		
54-2343B	Small Replacement Blades For 54-2343			2½ x 1¾ in	64 x 44 mm

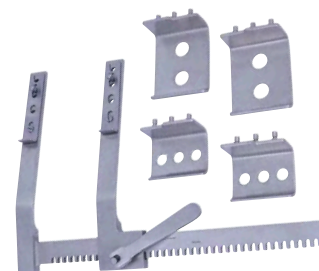

54-2343

Finochietto Rib Spreader

CODE	DESCRIPTION	BLADE (W X D)		SPREAD	
54-2301	Retractor Arms Angled Down	1½ x 1¼ in	38 x 32 mm	6 in	152 mm
54-2302	Retractor Arms Angled Down	2½ x 1¾ in	64 x 44 mm	8 in	203 mm
54-2303	Retractor Arms Angled Down	2½ x 2¾ in	64 x 70 mm	10 in	254 mm



54-2301

Haight-Finochietto Rib Spreader

CODE	DESCRIPTION	SPREAD		LENGTH	
50-8028	Child Size	4 in	102 mm	4 in	102 mm



50-8028

Reinhoff-Finochietto Rib Spreader

CODE	BLADES		SPREAD	
54-2402	1⅛ x 1¼ in	29 x 32 mm	6½ in	165 mm
54-2403	1⅛ x 1¾ in	27 x 44 mm	7½ in	191 mm
54-2404	1⅞ x 1¾ in	48 x 44 mm	8½ in	216 mm



54-2402

Spreaders (Rib Spreader)

Tuffier Rib Spreader

CODE	DESCRIPTION	BLADE (W X D)	SPREAD
54-2241	Scored Blades	1¾ x 2 in 44 x 51 mm	6¼ in 159 mm
54-2242	Serrated Blades	1¾ x 2 in 44 x 51 mm	6¼ in 159 mm



54-2241

Stringers (Instrument Holder)

Bunts Instrument Holder

CODE	DESCRIPTION	LENGTH
28-4008	One Dozen Per Package	3⅞ in 98 mm



Weisenbach Instrument Holder

CODE	DESCRIPTION	LENGTH
28-4010	Forceps Holder	6 in 152 mm



Stringers (Instrument Holder)

Weisenbach Instrument Holder

Instrument Stringer Open End

CODE	WIDTH	LENGTH	CODE	WIDTH	LENGTH
28-4011	2½ in 64 mm	12 in 305 mm	52-0010-6	6 in 152 mm	10 in 254 mm
52-0006	2½ in 64 mm	6 in 152 mm	52-0012	2½ in 64 mm	12 in 305 mm
52-0006-3	3 in 76 mm	6 in 152 mm	52-0012-3	3 in 76 mm	12 in 305 mm
52-0006-4	4 in 102 mm	6 in 152 mm	52-0012-4	4 in 102 mm	12 in 305 mm
52-0006-6	6 in 152 mm	6 in 152 mm	52-0012-6	6 in 152 mm	12 in 305 mm
52-0007	2½ in 64 mm	7 in 178 mm	52-0014	2½ in 64 mm	14 in 356 mm
52-0007-3	3 in 76 mm	7 in 178 mm	52-0014-4	4 in 102 mm	14 in 356 mm
52-0008	2½ in 64 mm	8 in 203 mm	52-0014-6	6 in 152 mm	14 in 356 mm
52-0008-3	3 in 76 mm	8 in 203 mm	52-0016	2½ in 64 mm	16 in 406 mm
52-0008-4	4 in 102 mm	8 in 203 mm	52-0016-5	5 in 127 mm	16 in 406 mm
52-0008-5	5 in 127 mm	8 in 203 mm	52-0018	2½ in 64 mm	18 in 458 mm
52-0010	2½ in 64 mm	10 in 254 mm	52-0018-3	3 in 76 mm	18 in 458 mm
52-0010-4	4 in 102 mm	10 in 254 mm	52-0018-4	4 in 102 mm	18 in 458 mm
52-0010-5	5 in 127 mm	10 in 254 mm			



28-4011

Stringers (Instrument Holder)

Rhode Island Hospital Instrument Holder

CODE	DESCRIPTION	LENGTH
21-4003	Instrument Holder	12 in 305 mm



Stringers (Instrument Holder)

Sterilization Rack

CODE	DESCRIPTION	LENGTH	
32-3345	For Ring Handle Forceps	12 x 3 in	305 x 76 mm
32-3346	For Ring Handle Forceps	5 ⁷ / ₈ x 3 ¹ / ₈	149 x 79 mm
32-3347	For Ring Handle Forceps	7 ⁷ / ₈ x 3 ¹ / ₈	200 x 79 mm
32-3348	For Ring Handle Forceps	9 ⁷ / ₈ x 3 ¹ / ₈	251 x 79 mm



32-3345

Strippers

Disposable Vein Stripper

Sterile, Each Package Includes Three Olives (S,M,L), One Handle and Two Stripper Cables

CODE	DESCRIPTION	LENGTH
63-4031	Disposable Vein Stripper	³ / ₈ in 10 mm



Endarterectomy Strippers



09-9619

Endarterectomy Stripper

CODE	DESCRIPTION	LENGTH	CODE	DESCRIPTION	LENGTH
09-9602	2.0 mm	21 ¹ / ₁₆ in 535 mm	09-9609	9.0 mm	21 ³ / ₄ in 552 mm
09-9603	3.0 mm	21 ¹ / ₁₆ in 535 mm	09-9610	10 mm	21 ³ / ₄ in 552 mm
09-9604	4.0 mm	21 ¹ / ₁₆ in 535 mm	09-9611	11 mm	21 ³ / ₄ in 552 mm
09-9605	5.0 mm	21 ¹ / ₁₆ in 535 mm	09-9612	12 mm	21 ³ / ₄ in 552 mm
09-9606	6.0 mm	21 ¹ / ₁₆ in 535 mm	09-9613	14 mm	21 ³ / ₄ in 552 mm
09-9607	7.0 mm	21 ¹ / ₁₆ in 535 mm	09-9619	Handle	21 ³ / ₄ in 552 mm
09-9608	8.0 mm	21 ¹ / ₁₆ in 535 mm			

Vein Strippers

Mayo Vein Stripper

CODE	DESCRIPTION	DIAMETER	LENGTH
09-9581	Angled Shaft	4.8 mm	15 ³ / ₈ in 391 mm



Suction Tubes (Sump)

Opti-Length® Left Ventricular Sump

CODE	DESCRIPTION	TIP WIDTH	LENGTH
67-7677	45°, Perforated	5/16 in 8.0 mm	19 3/4 in 502 mm

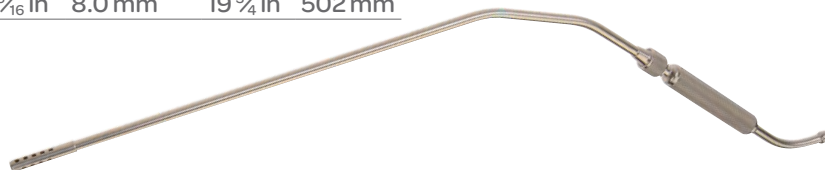

Suction Tubes

Andrews-Pynchon Suction Tube, Opti-Length® Suction

CODE	DESCRIPTION	LENGTH
70-6560	Suction Tube	9 1/2 in 241 mm
67-7675	Suction Tube	11 in 279 mm



70-6560

Pacifico Suction Tube

Diameter Tapers 11-8, French Width 5/8 in (22 mm)

CODE	DESCRIPTION	LENGTH
70-8048	Large	7 1/2 in 191 mm



Pool Suction Tube

CODE	DESCRIPTION	LENGTH
70-4000	Curved Tubing Connection	23 Fr x 9 1/4 in 23 Fr x 235 mm
70-4001	Straight Tubing Connection	30 Fr x 9 5/8 in 30 Fr x 244 mm
70-4002	Straight Tubing Connection, with Finger Cut-Off	30 Fr x 10 1/4 in 30 Fr x 260 mm



70-4000

Suction Tubes

Suction Tube

CODE	WORKING DISTANCE		LENGTH	
32-3360	9 ³ / ₄ in	248 mm	12 in	305 mm
32-3361	12 ³ / ₄ in	324 mm	15 in	381 mm



32-3360

Yankauer Suction Tubes

CODE	DESCRIPTION	WORKING DISTANCE		LENGTH	
70-4026	Removable Tip, Standard			10 ³ / ₈ in	264 mm
70-4024	With Thumb Control			11 ¹ / ₄ in	286 mm
32-3362	With Thumb Control	5 ⁷ / ₈ in	149 mm	12 ³ / ₄ in	324 mm

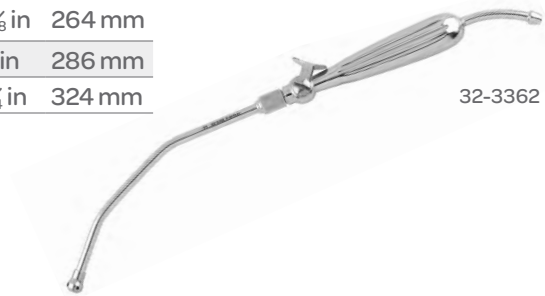

32-3362

Suction Tubes (Holders)

Green Suction Tube Holder

CODE	DESCRIPTION	LENGTH	
70-4142	Tube Holder	6 ¹ / ₂ in	165 mm



Suction Tubes (Vascular)

Methodist Vascular Suction Tube

CODE	DESCRIPTION	LENGTH	
70-8040	Diameter ³ / ₈ in (10 mm)	10 in	254 mm



Suction Tubes (Vascular)

Vascular Suction Tube

CODE	DESCRIPTION	DIAMETER	LENGTH
54-6038	Angled		11 in 279 mm
70-8036	Round Perforated End	¼ in 6.0 mm	11½ in 292 mm



Sump Suction

Cooley Right Angle Sump Suction Tube

CODE	DESCRIPTION
54-6013	Right Angle Sump Suction



Tourniquets

Rumel Cardiovascular Tourniquets

CODE	DESCRIPTION	LENGTH
67-8004	Child, Obturator Only	6 in 152 mm
67-8001	Adult, Obturator Only	9 in 229 mm
67-8000	Adult, with Ratchet and Tourniquet with Obturator	12 in 305 mm



Trocars

Hurwitz Thoracic Trocar

CODE	SIZE	GAUGE	LENGTH
54-7003	Large	36 French, Up to 26 French Foley	8 in 203 mm



Nelson (Patterson) Trocar

CODE	SIZE	GAUGE	LENGTH
54-7007	Small	18 French	¼ in 6.0 mm
54-7005	Medium-Large	32 French	¾ in 10 mm
54-7004	Large, for Intercostal Drainage	36 French	7/16 in 11 mm



Tunnelers (A-V Fistula)

Noon A-V Fistula Tuner

CODE	DESCRIPTION	LENGTH	
80-8006	Tuner	9 in	229 mm



Tunnelers (Cone Tip)

Bullet Cone Tip Tuner

With Removable Tip

CODE	DESCRIPTION	LENGTH	
55-6710	Slightly Curved	11 ³ / ₄ in	298 mm
55-6712	Slightly Curved	15 ³ / ₄ in	400 mm
55-6714	Slightly Curved	19 ³ / ₄ in	502 mm
55-6716	Slightly Curved	27 ¹ / ₂ in	699 mm



Tunnelers

Crawford-Cooley Tuner

CODE	DESCRIPTION	LENGTH	
55-6083	Tube Is 400 mm Long, 12 mm in Diameter	18 in	458 mm



Tunnelers (Tunneling Forceps)

Hallman Tunneling Forceps

CODE	DESCRIPTION	LENGTH	
55-6086	Tunneling Forceps	14 in	356 mm

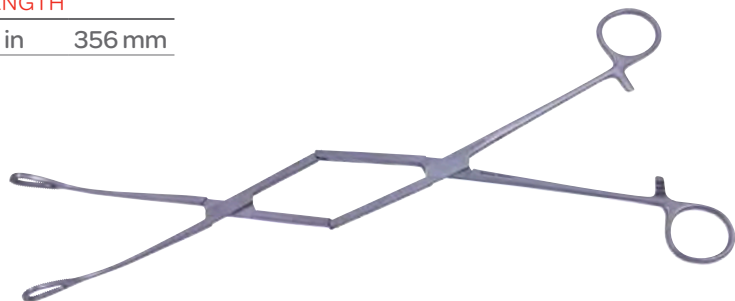

Valvulotomes

Valvulotome

CODE	DESCRIPTION	LENGTH
55-8681	Antegrade	6 ¼ in 159 mm
55-8683	Antegrade	12 in 305 mm
55-8685	Retrograde	6 ¼ in 159 mm
55-8680	Retrograde	9 ½ in 241 mm
55-8682	Retrograde	12 in 305 mm

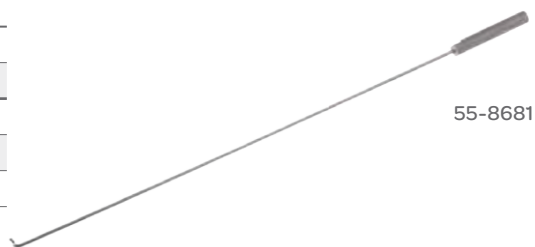

55-8681

Wire & Pin Cutters

Ochsner Wire Twister

CODE	DESCRIPTION	LENGTH
73-4005	Threaded Shaft for Rotation, Tungsten Carbide Jaw Inserts	10 ½ in 267 mm



Wire Cutter

CODE	DESCRIPTION	LENGTH
56-2510	Stainless Steel	7 in 178 mm



Wire Cutter, Double Action Side Cut

CODE	DESCRIPTION	LENGTH
32-3371	Straight Jaw	9 in 229 mm
32-3372	Angled Jaw	6 ½ in 165 mm
32-3373	Angled Jaw	9 in 229 mm



32-3372

Wire Cutters

CODE	DESCRIPTION	LENGTH
32-3341	Tungsten Carbide Inserts	7 in 178 mm





Scan the code above
to learn more about
our Energy portfolio.

Energy Portfolio



symmetry surgical™

Energy

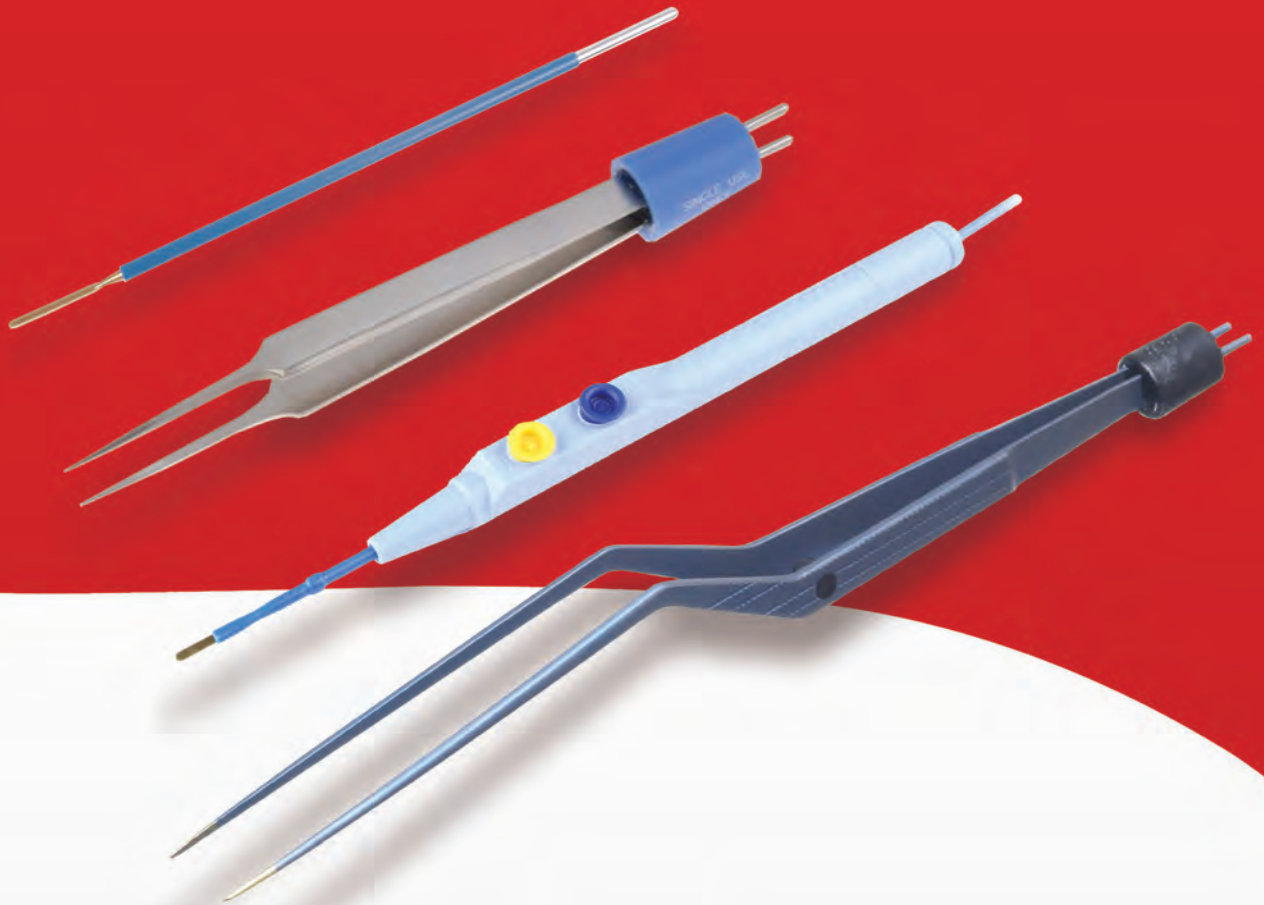

Electrosurgery Reference	ENG-2
Olsen® Single-Use Bayonet Bipolar Forceps	ENG-3
Olsen® Single-Use Bipolar Forceps	ENG-8
Olsen®/Ultra™ Reusable Bayonet Bipolar Forceps	ENG-12
Olsen®/Ultra™ Reusable Bipolar Forceps	ENG-22
Olsen® Single-Use Monopolar Forceps	ENG-26
Olsen® Reusable Bayonet Monopolar Forceps	ENG-27
Olsen® Reusable Monopolar Forceps	ENG-29
Olsen® Monopolar Electrodes	ENG-31
Monopolar Electrodes	ENG-34
Ultra™ Monopolar Laparoscopic Forceps	ENG-35

Olsen® Monopolar Blade Electrodes	ENG-50
Olsen® Electrode Extenders	ENG-51
Ultra™ Laparoscopic Electrodes	ENG-51
Olsen® Monopolar Loop Electrodes	ENG-52
Olsen® Monopolar Needle Electrodes	ENG-53
Olsen® Suction Coagulators	ENG-57
Olsen® Electrosurgical Cords	ENG-58
Olsen® Exposed Top Forceps	ENG-60
Olsen® Monopolar Adapters	ENG-61
Olsen® Monopolar Pencils	ENG-62
Olsen® Energy Accessories	ENG-64

Questions? Contact us at customerservice@symmetrysurgical.com or learn more at symmetrysurgical.com

The Surgical Instrument Desk Reference

How to Use Our Catalog

The Symmetry Surgical catalog is designed with you in mind, to be your trusted resource for surgical instrumentation. We took great care in creating an easy-to-use, robust catalog and we think you'll be pleased with the design as you become more familiar with our broad portfolio.

Layout

The catalog is organized by surgical specialty *and* product function.

And we know that it is difficult to pick up an instrument and know what specialty it's listed in. To make your job easier, we've sorted the instruments in our portfolio by surgical function, too, including Energy, Laparoscopic, Retractors and Sterilization Solutions.

U.S. Customer Service

Your Symmetry Surgical Customer Service team wants to make ordering surgical instruments the easiest part of your day. We accept orders via phone, fax, email, our website, Global Healthcare Exchange (GHX) and through the mail.

PHONE

800.251.3000

(Available Monday through Friday, 8:30 AM–6:30 PM EST)

FAX

800.342.3272

EMAIL

customerservice@symmetrysurgical.com

ONLINE

symmetrysurgical.com

MAILING ADDRESS

Symmetry Surgical
Attn: Customer Service
3034 Owen Drive
Antioch, TN 37013

The Surgical Instrument Desk Reference

International Customer Service

PHONE

Symmetry Surgical Switzerland GmbH
+41 (0) 52 557 59 00
(Available Monday through Friday, 7:00-16:00 GMT)

Symmetry Surgical, Inc., USA
615.964.5672
(Available Monday through Friday, 8:30 AM-6:30 PM EST)

FAX

Symmetry Surgical Switzerland GmbH
+41 (0) 52 557 59 99

EMAIL

customerservice@symmetrysurgical.com
internationalorders@symmetrysurgical.com

ONLINE

symmetrysurgical.com

MAILING ADDRESS

Symmetry Surgical Switzerland GmbH
Bühlstrasse 27
CH-8200 Schaffhausen
Switzerland

Symmetry Surgical, Inc.
3034 Owen Drive
Antioch, TN 37013

INTERNATIONAL PAYMENT TERMS/RETURN GOODS POLICY/INSTRUMENT REPAIR & RESTORE PROGRAM/LITERATURE REQUESTS

Please contact your local distributor. Locate a local distributor contact, International Customer Service at +41 (0) 52 557 59 00 or 615.964.5672 (US).

Cardiovascular/Thoracic

Energy

Ear, Nose & Throat

General

Laparoscopic

Neurology

Obesity

OB/GYN

Ophthalmology

Orthopedics & Arthroscopy

Pediatrics

Rectal

Retractors

Spine

Urology

Sterilization Solutions

Alphabetical & Numeric Indexes

Electrosurgery Reference

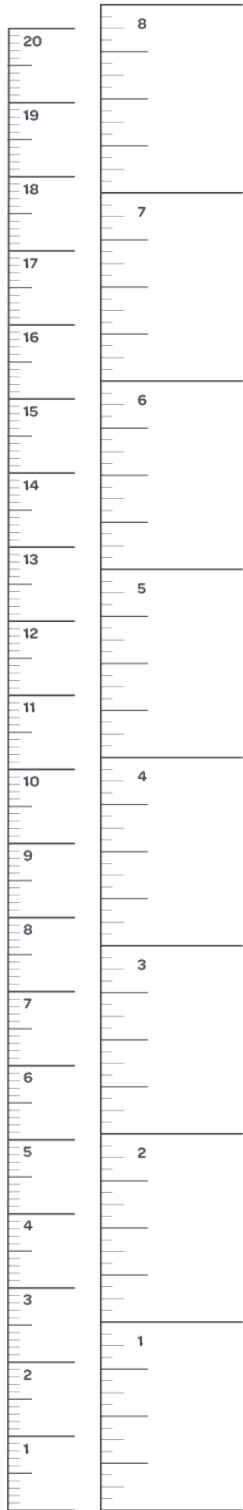

Abbreviation Key

- “L” Total Length
- “WL” Working Length

Forceps Measuring Key

To determine the correct length of desired forceps, measure per corresponding key as illustrated. Use the rulers to the left to help determine the forcep length.

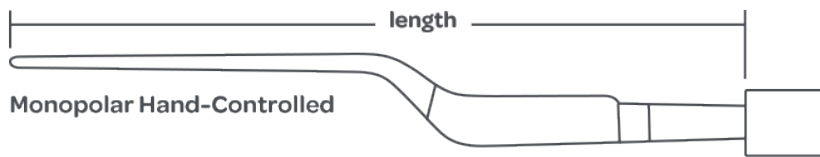
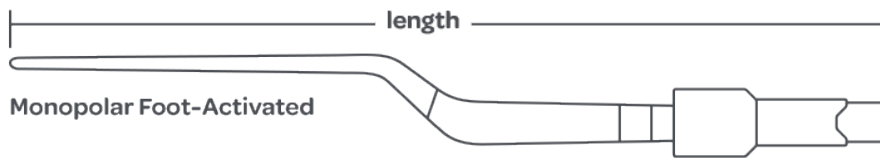
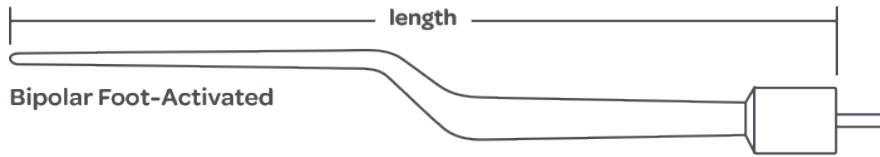

Forceps Tip Sizes

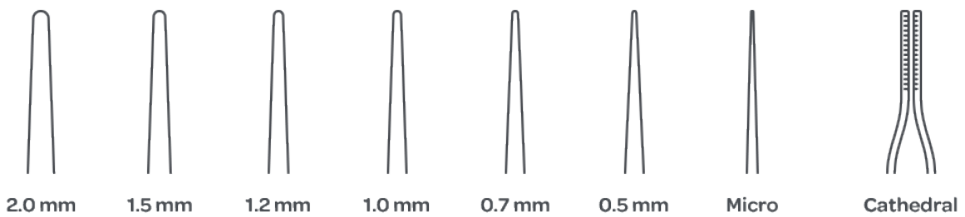

Single-use products are sold sterile.
Kits Include Forceps, 12 ft (3.6 m) Cord and Surgi-Wipe.

Olsen® Single-Use Bayonet Bipolar Forceps



20-1320

Single-Use Bayonet Bipolar Forceps

Smooth Tips, 10 per Box

Length (L)	6 ½ in 165 mm	6 ½ in 165 mm	6 ½ in 165 mm	6 ½ in 165 mm
Working (WL)	3 ¾ in 95 mm	3 ¾ in 95 mm	3 ¾ in 95 mm	3 ¾ in 95 mm
TIP SIZE	FORCEPS, NON-INSULATED	FORCEPS, INSULATED	KIT, NON-INSULATED	KIT, INSULATED
0.5 mm	20-1315	20-1315I	20-1315K	20-1315KI
0.75 mm	20-1320-OL	20-1320I	20-1320K	20-1320KI
1.0 mm	20-1325	20-1325I	20-1325K	20-1325KI
1.5 mm	20-1330	20-1330I	20-1330K	20-1330KI



20-1370

Single-Use Bayonet Bipolar Forceps

Smooth Tips, 10 per Box

Length (L)	7 ¼ in 184 mm	7 ¼ in 184 mm	7 ¼ in 184 mm	7 ¼ in 184 mm
Working (WL)	2 ¾ in 70 mm	2 ¾ in 70 mm	2 ¾ in 70 mm	2 ¾ in 70 mm
TIP SIZE	FORCEPS, NON-INSULATED	FORCEPS, INSULATED	KIT, NON-INSULATED	KIT, INSULATED
0.5 mm	20-1355	20-1355I	20-1355K	20-1355KI
0.75 mm	20-1360	20-1360I	20-1360K	20-1360KI
1.0 mm	20-1340	20-1340I	20-1340K	20-1340KI
1.5 mm	20-1370	20-1370I	20-1370K	20-1370KI
2.0 mm	20-1375	20-1375I	20-1375K	20-1375KI

Single-use products are sold sterile.
Kits Include Forceps, 12 ft (3.6 m) Cord and Surgi-Wipe.

Questions? Contact us at customerservice@symmetrysurgical.com
or learn more at symmetrysurgical.com

Olsen® Single-Use Bayonet Bipolar Forceps



Single-Use Bayonet Bipolar Forceps

Smooth Tips, 10 per Box

Length (L)	7¾ in 197 mm	7¾ in 197 mm	7¾ in 197 mm	7¾ in 197 mm
Working (WL)	3 in 76 mm	3 in 76 mm	3 in 76 mm	3 in 76 mm

TIP SIZE	FORCEPS, NON-INSULATED	FORCEPS, INSULATED	KIT, NON-INSULATED	KIT, INSULATED
0.5 mm	20-1386	20-1386I	20-1386K	20-1386KI
0.75 mm	20-1384	20-1384I	20-1384K	20-1384KI
1.0 mm	20-1382	20-1382I	20-1382K	20-1382KI
1.5 mm	20-1380	20-1380I	20-1380K	20-1380KI

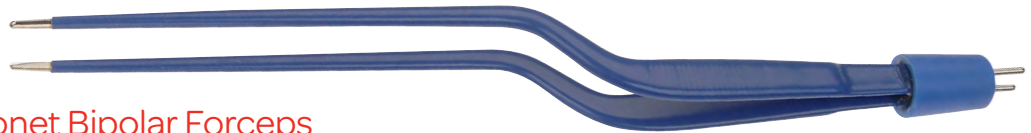

Single-Use Bayonet Bipolar Forceps

Smooth Tips, 10 per Box

Length (L)	8¼ in 210 mm	8¼ in 210 mm	8¼ in 210 mm	8¼ in 210 mm
Working (WL)	4⅛ in 105 mm	4⅛ in 105 mm	4⅛ in 105 mm	4⅛ in 105 mm

TIP SIZE	FORCEPS, NON-INSULATED	FORCEPS, INSULATED	KIT, NON-INSULATED	KIT, INSULATED
0.5 mm	20-1420	20-1420I	20-1420K	20-1420KI
0.75 mm	20-1400	20-1400I	20-1400K	20-1400KI
1.0 mm	20-1440	20-1440I	20-1440K	20-1440KI
1.5 mm	20-1410	20-1410I	20-1410K	20-1410KI
2.0 mm	20-1415	20-1415I	20-1415K	20-1415KI

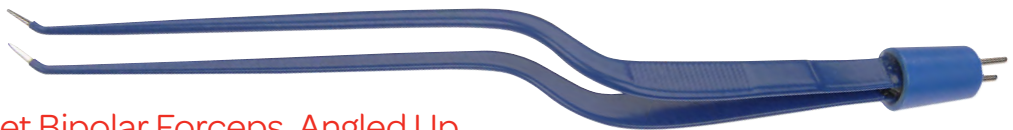

Single-Use Bayonet Bipolar Forceps, Angled Up

Smooth Tips, 10 per Box

Length (L)	8¼ in 210 mm	8¼ in 210 mm	8¼ in 210 mm	8¼ in 210 mm
Working (WL)	4⅛ in 105 mm	4⅛ in 105 mm	4⅛ in 105 mm	4⅛ in 105 mm

TIP SIZE	FORCEPS, NON-INSULATED	FORCEPS, INSULATED	KIT, NON-INSULATED	KIT, INSULATED
1.0 mm	20-1445	20-1445I	20-1445K	20-1445KI

Single-use products are sold sterile.
Kits Include Forceps, 12 ft (3.6 m) Cord and Surgi-Wipe.

Olsen® Single-Use Bayonet Bipolar Forceps



Single-Use Bayonet Bipolar Forceps

Smooth Tips, 10 per Box

Length (L)	10 ½ in 267 mm	10 ½ in 267 mm	10 ½ in 267 mm	10 ½ in 267 mm
Working (WL)	6 in 152 mm	6 in 152 mm	6 in 152 mm	6 in 152 mm

TIP SIZE	FORCEPS, NON-INSULATED	FORCEPS, INSULATED	KIT, NON-INSULATED	KIT, INSULATED
0.5 mm	20-1484	20-1484I	20-1484K	20-1484KI
0.75 mm	20-1486	20-1486I	20-1486K	20-1486KI
1.0 mm	20-1480	20-1480I	20-1480K	20-1480KI
1.5 mm	20-1481	20-1481I	20-1481K	20-1481KI



Single-Use Delashaw* Bayonet Bipolar Forceps

Smooth Tips, 10 per Box

CODE	DESCRIPTION	TIP SIZE	LENGTH
20-1350	Forceps, Non-Insulated	Micro	7 ¼ in 184 mm
20-1350I	Forceps, Insulated	Micro	7 ¼ in 184 mm
20-1350K	Kit, Non-Insulated	Micro	7 ¼ in 184 mm
20-1350KI	Kit, Insulated	Micro	7 ¼ in 184 mm

*Developed by Johnny Delashaw, Jr., M.D.

Single-Use Bayonet Bipolar Forceps, Acute Angle

Smooth Tips, 10 per Box

Length (L)	6 ¼ in 159 mm	6 ¼ in 159 mm	6 ¼ in 159 mm	6 ¼ in 159 mm
Working (WL)	3 ½ in 89 mm	3 ½ in 89 mm	3 ½ in 89 mm	3 ½ in 89 mm

TIP SIZE	FORCEPS, NON-INSULATED	FORCEPS, INSULATED	KIT, NON-INSULATED	KIT, INSULATED
0.75 mm	20-1500	20-1500I	20-1500K	20-1500KI
1.0 mm	20-1510	20-1510I	20-1510K	20-1510KI
1.5 mm	20-1520	20-1520I	20-1520K	20-1520KI

Single-use products are sold sterile.

Kits Include Forceps, 12 ft (3.6 m) Cord and Surgi-Wipe.

Questions? Contact us at customerservice@symmetrysurgical.com or learn more at symmetrysurgical.com

Olsen® Single-Use Bayonet Bipolar Forceps

Single-Use Bayonet Bipolar Forceps, Acute Angle

Smooth Tips, 10 per Box

Length (L)	7½ in 191 mm	7½ in 191 mm	7½ in 191 mm	7½ in 191 mm
Working (WL)	4⅛ in 105 mm	4⅛ in 105 mm	4⅛ in 105 mm	4⅛ in 105 mm

TIP SIZE	FORCEPS, NON-INSULATED	FORCEPS, INSULATED	KIT, NON-INSULATED	KIT, INSULATED
0.75 mm	20-1530	20-1530I	20-1530K	20-1530KI
1.0 mm	20-1540	20-1540I	20-1540K	20-1540KI
1.5 mm	20-1550	20-1550I	20-1550K	20-1550KI

Length (L)	8⅜ in 213 mm	8⅜ in 213 mm	8⅜ in 213 mm	8⅜ in 213 mm
Working (WL)	5⅞ in 130 mm	5⅞ in 130 mm	5⅞ in 130 mm	5⅞ in 130 mm

TIP SIZE	FORCEPS, NON-INSULATED	FORCEPS, INSULATED	KIT, NON-INSULATED	KIT, INSULATED
0.75 mm	20-1560	20-1560I	20-1560K	20-1560KI
1.0 mm	20-1570	20-1570I	20-1570K	20-1570KI
1.5 mm	20-1580	20-1580I	20-1580K	20-1580KI



Single-Use Bayonet Bipolar Forceps, Angled Up

Smooth Tips, 10 per Box

Length (L)	10½ in 267 mm	10½ in 267 mm	10½ in 267 mm	10½ in 267 mm
Working (WL)	6 in 152 mm	6 in 152 mm	6 in 152 mm	6 in 152 mm

TIP SIZE	FORCEPS, NON-INSULATED	FORCEPS, INSULATED	KIT, NON-INSULATED	KIT, INSULATED
1.0 mm		20-1682I		20-1682KI



Single-Use Bayonet Bipolar Forceps, with Midas Touch® Non-Stick Tips

Smooth Tips, 5 per Box

Length (L)	6½ in 165 mm	7½ in 191 mm	8¼ in 210 mm	10½ in 267 mm
Working (WL)	3¾ in 95 mm	3 in 76 mm	4⅞ in 105 mm	6 in 152 mm

TIP SIZE	INSULATED	INSULATED	INSULATED	INSULATED
0.5 mm	20-1315IMT	20-1386IMT	20-1420IMT	
0.75 mm	20-1320IMT	20-1384IMT	20-1400IMT	
1.0 mm	20-1325IMT	20-1382IMT	20-1440IMT	20-1480IMT
1.5 mm	20-1330IMT	20-1380IMT	20-1410IMT	
2.0 mm			20-1415IMT	

Single-use products are sold sterile.
Kits Include Forceps, 12 ft (3.6 m) Cord and Surgi-Wipe.

Olsen® Single-Use Bayonet Bipolar Forceps

Single-Use Bayonet Tonsil Bipolar Forceps

Smooth Tips, Angled Down, Insulated, 10 per Box

Length (L)	7½ in	191 mm	7½ in	191 mm
Working (WL)	3 in	76 mm	3 in	76 mm
TIP SIZE	FORCEPS, INSULATED		KIT, INSULATED	
1.5 mm	20-1381I		20-1381KI	



Single-Use Irrigating Bayonet Bipolar Forceps

Smooth Tips, 5 per Box

Length (L)	6¼ in	159 mm	7¼ in	184 mm	8¼ in	210 mm	10½ in	267 mm
Working (WL)	2¾ in	70 mm	2¾ in	70 mm	4¼ in	108 mm	6¼ in	159 mm
TIP SIZE	INSULATED		INSULATED		INSULATED		INSULATED	
0.5 mm	20-0311		20-0361		20-0411			
1.0 mm	20-0321		20-0371		20-0421		20-0481	
1.5 mm	20-0331		20-0381		20-0431		20-0491	
Micro			20-0351					

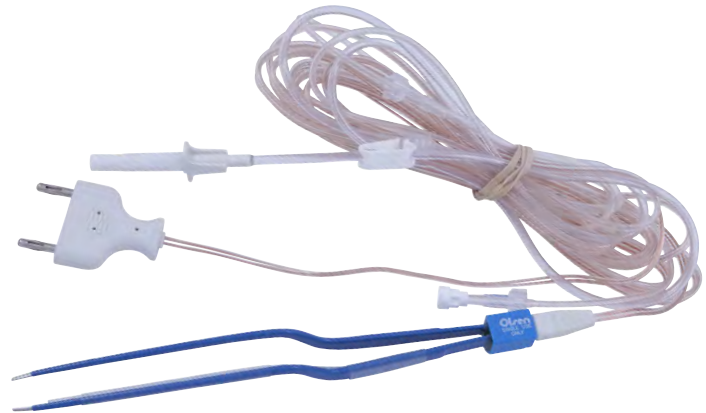

Single-Use Irrigating Bayonet Bipolar Forceps, Single-Use Kits for Rotary Pumps

Smooth Tips, 5 per Box, with 12 ft Integrated Tubing/Cord Set

Length (L)	6¼ in	159 mm	7¼ in	184 mm	8¼ in	210 mm	10½ in	267 mm
Working (WL)	2¾ in	70 mm	2¾ in	70 mm	4¼ in	108 mm	6¼ in	159 mm
TIP SIZE	INSULATED		INSULATED		INSULATED		INSULATED	
0.5 mm	20-0311R		20-0361R		20-0411R			
1.0 mm	20-0321R		20-0371R		20-0421R		20-0481R	
1.5 mm	20-0331R		20-0381R		20-0431R		20-0491R	

Single-use products are sold sterile.
Kits Include Forceps, 12 ft (3.6 m) Cord and Surgi-Wipe.

Questions? Contact us at customerservice@symmetrysurgical.com
or learn more at symmetrysurgical.com

Olsen® Single-Use Bipolar Forceps

Single-Use Adson Bipolar Forceps, Serrated Tip

10 per Box

CODE	DESCRIPTION	TIP SIZE	LENGTH
20-1080	Forceps, Non-Insulated	1.0 mm	5 in 127 mm
20-1080I	Forceps, Insulated	1.0 mm	5 in 127 mm
20-1080K	Kit, Non-Insulated	1.0 mm	5 in 127 mm
20-1080KI	Kit, Insulated	1.0 mm	5 in 127 mm



Single-Use Adson Bipolar Forceps, Smooth Tip

10 per Box

CODE	DESCRIPTION	TIP SIZE	LENGTH
20-1082	Forceps, Non-Insulated	1.0 mm	5 in 127 mm
20-1082I	Forceps, Insulated	1.0 mm	5 in 127 mm
20-1082K	Kit, Non-Insulated	1.0 mm	5 in 127 mm
20-1082KI	Kit, Insulated	1.0 mm	5 in 127 mm



Single-Use Adson Bipolar Forceps, with Midas Touch® Non-Stick Tips

5 per Box

CODE	DESCRIPTION	TIP SIZE	LENGTH
20-1082IMT	Forceps, Non-Stick	1.0 mm	5 in 127 mm



Single-Use Coaptation Bipolar Forceps

Smooth Tips, 10 per Box

CODE	DESCRIPTION	TIP SIZE	LENGTH
20-1010-OL	Forceps, Non-Insulated	Micro	4 ½ in 114 mm
20-1010I	Forceps, Insulated	Micro	4 ½ in 114 mm
20-1010K	Kit, Non-Insulated	Micro	4 ½ in 114 mm
20-1010KI	Kit, Insulated	Micro	4 ½ in 114 mm



Single-use products are sold sterile.
Kits Include Forceps, 12 ft (3.6 m) Cord and Surgi-Wipe.

Olsen® Single-Use Bipolar Forceps

Single-Use Cushing Bipolar Forceps

Smooth Tips, 10 per Box

CODE	DESCRIPTION	TIP SIZE	LENGTH
20-1160	Forceps, Non-Insulated	1.0 mm	7 in 178 mm
20-1160I	Forceps, Insulated	1.0 mm	7 in 178 mm
20-1160K	Kit, Non-Insulated	1.0 mm	7 in 178 mm
20-1160KI	Kit, Insulated	1.0 mm	7 in 178 mm
20-1162	Forceps, Non-Insulated	1.5 mm	7 in 178 mm
20-1162I	Forceps, Insulated	1.5 mm	7 in 178 mm
20-1162K	Kit, Non-Insulated	1.5 mm	7 in 178 mm
20-1162KI	Kit, Insulated	1.5 mm	7 in 178 mm



Single-Use Gerald Bipolar Forceps

Smooth Tips, 10 per Box

CODE	DESCRIPTION	TIP SIZE	LENGTH
20-1180	Forceps, Non-Insulated	1.0 mm	7 ¼ in 184 mm
20-1180I	Forceps, Insulated	1.0 mm	7 ¼ in 184 mm
20-1180K	Kit, Non-Insulated	1.0 mm	7 ¼ in 184 mm
20-1180KI	Kit, Insulated	1.0 mm	7 ¼ in 184 mm



Single-Use Iris Bipolar Forceps, Straight

Serrated Tips, 10 per Box

CODE	DESCRIPTION	TIP SIZE	LENGTH
20-1030	Forceps, Non-Insulated	1.0 mm	4 ½ in 114 mm
20-1030I	Forceps, Insulated	1.0 mm	4 ½ in 114 mm
20-1030K	Kit, Non-Insulated	1.0 mm	4 ½ in 114 mm
20-1030KI	Kit, Insulated	1.0 mm	4 ½ in 114 mm



Single-Use Iris Bipolar Forceps, Angled

Serrated Tips, 10 per Box

CODE	DESCRIPTION	TIP SIZE	LENGTH
20-1040	Forceps, Non-Insulated	1.0 mm	4 ½ in 114 mm
20-1040I	Forceps, Insulated	1.0 mm	4 ½ in 114 mm
20-1040K	Kit, Non-Insulated	1.0 mm	4 ½ in 114 mm
20-1040KI	Kit, Insulated	1.0 mm	4 ½ in 114 mm



Single-use products are sold sterile.

Kits Include Forceps, 12 ft (3.6 m) Cord and Surgi-Wipe.

Questions? Contact us at customerservice@symmetryurgical.com or learn more at symmetryurgical.com

Olsen® Single-Use Bipolar Forceps

Single-Use Jewelers Bipolar Forceps, Straight

Smooth Tips, 10 per Box

CODE	DESCRIPTION	TIP SIZE	LENGTH
20-1060	Forceps, Non-Insulated	Micro	4 ¾ in 121 mm
20-1060I	Forceps, Insulated	Micro	4 ¾ in 121 mm
20-1060K	Kit, Non-Insulated	Micro	4 ¾ in 121 mm
20-1060KI	Kit, Insulated	Micro	4 ¾ in 121 mm



Single-Use Jewelers Bipolar Forceps, Curved

Smooth Tips, 10 per Box

CODE	DESCRIPTION	TIP SIZE	LENGTH
20-1070	Forceps, Non-Insulated	Micro	4 ¾ in 121 mm
20-1070I	Forceps, Insulated	Micro	4 ¾ in 121 mm
20-1070K	Kit, Non-Insulated	Micro	4 ¾ in 121 mm
20-1070KI	Kit, Insulated	Micro	4 ¾ in 121 mm



Single-Use Jewelers Bipolar Forceps, Straight, Ridged Handle

Smooth Tips, 10 per Box

CODE	DESCRIPTION	TIP SIZE	LENGTH
20-1203	Forceps, Non-Insulated	Micro	3 ⅞ in 98 mm
20-1203I	Forceps, Insulated	Micro	3 ⅞ in 98 mm
20-1203K	Kit, Non-Insulated	Micro	3 ⅞ in 98 mm
20-1203KI	Kit, Insulated	Micro	3 ⅞ in 98 mm

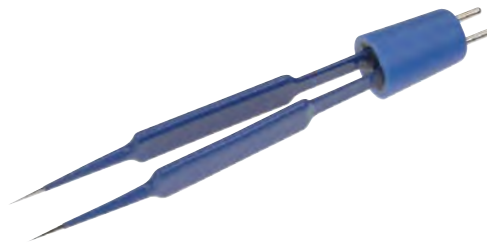

Single-Use Jewelers Bipolar Forceps, with Midas Touch® Non-Stick Tips

Insulated, Smooth Tips, 5 per Box

CODE	DESCRIPTION	TIP SIZE	LENGTH
20-1060IMT	Forceps, Non-Stick	Micro	4 ¾ in 121 mm



Single-use products are sold sterile.
Kits Include Forceps, 12 ft (3.6 m) Cord and Surgi-Wipe.

Olsen® Single-Use Bipolar Forceps

Single-Use McPherson Bipolar Forceps, Angled

Smooth Tips, 10 per Box

CODE	DESCRIPTION	TIP SIZE	LENGTH
20-1200	Forceps, Non-Insulated	0.5 mm	3 7/8 in 98 mm
20-1200I	Forceps, Insulated	0.5 mm	3 7/8 in 98 mm
20-1200K	Kit, Non-Insulated	0.5 mm	3 7/8 in 98 mm
20-1200KI	Kit, Insulated	0.5 mm	3 7/8 in 98 mm



Single-Use McPherson Bipolar Forceps, Straight

Smooth Tips, 10 per Box

CODE	DESCRIPTION	TIP SIZE	LENGTH
20-1201	Forceps, Non-Insulated	0.5 mm	3 7/8 in 98 mm
20-1201I	Forceps, Insulated	0.5 mm	3 7/8 in 98 mm
20-1201K	Kit, Non-Insulated	0.5 mm	3 7/8 in 98 mm
20-1201KI	Kit, Insulated	0.5 mm	3 7/8 in 98 mm
20-1020	Forceps, Non-Insulated	0.5 mm	4 1/4 in 108 mm
20-1020I	Forceps, Insulated	0.5 mm	4 1/4 in 108 mm
20-1020K	Kit, Non-Insulated	0.5 mm	4 1/4 in 108 mm
20-1020KI	Kit, Insulated	0.5 mm	4 1/4 in 108 mm



Single-Use Semkin Bipolar Forceps

Smooth Tips, 10 per Box

CODE	DESCRIPTION	TIP SIZE	LENGTH
20-1190	Forceps, Non-Insulated	1.0 mm	5 1/2 in 140 mm
20-1190I	Forceps, Insulated	1.0 mm	5 1/2 in 140 mm
20-1190K	Kit, Non-Insulated	1.0 mm	5 1/2 in 140 mm
20-1190KI	Kit, Insulated	1.0 mm	5 1/2 in 140 mm
20-1090	Forceps, Non-Insulated	0.75 mm	5 3/4 in 146 mm
20-1090I	Forceps, Insulated	0.75 mm	5 3/4 in 146 mm
20-1090K	Kit, Non-Insulated	0.75 mm	5 3/4 in 146 mm
20-1090KI	Kit, Insulated	0.75 mm	5 3/4 in 146 mm



Single-Use Semkin Bipolar Forceps, with Midas Touch® Non-Stick Tips

Insulated, Smooth Tips, 5 per Box

CODE	DESCRIPTION	TIP SIZE	LENGTH
20-1090IMT	Forceps, Non-Stick	0.75 mm	5 3/4 in 146 mm

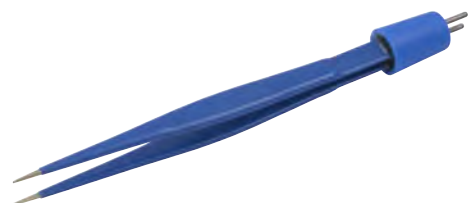

Single-use products are sold sterile.
Kits Include Forceps, 12 ft (3.6 m) Cord and Surgi-Wipe.

Questions? Contact us at customerservice@symmetrysurgical.com
or learn more at symmetrysurgical.com

Olsen®/Ultra™ Reusable Bayonet Bipolar Forceps



Bayonet Bipolar Forceps

Reusable, Smooth Tips, 1 Each

Length (L)	6½ in 165 mm	7¼ in 184 mm	8¼ in 210 mm	10½ in 267 mm
Working (WL)	2¾ in 70 mm	2¾ in 70 mm	4¼ in 108 mm	6¼ in 159 mm

TIP SIZE	NON-INSULATED	NON-INSULATED	NON-INSULATED	NON-INSULATED
0.5 mm	10-1311	10-1360	10-1421	10-1483
0.75 mm	10-1321	10-1361	10-1401	10-1485
1.0 mm	10-1322	10-1362	10-1431	10-1481
1.5 mm	10-1331	10-1371	10-1411	10-1484
2.0 mm		10-1372	10-1412	10-1487

Length (L)	6¼ in 159 mm	7⅞ in 181 mm	8¼ in 210 mm	10½ in 267 mm
Working (WL)	2¾ in 70 mm	2¾ in 70 mm	4¼ in 108 mm	6¼ in 159 mm

TIP SIZE	INSULATED	INSULATED	INSULATED	INSULATED
0.5 mm	10-1311I	10-1360I	10-1421I	10-1483I
0.75 mm	10-1321I	10-1361I	10-1401I	10-1485I
1.0 mm	10-1322I	10-1362I	10-1431I	10-1481I
1.5 mm	10-1331I	10-1371I	10-1411I	10-1484I
2.0 mm		10-1372I	10-1412I	10-1487I



Bayonet Bipolar Forceps

Reusable, Smooth Tips, 1 Each

Length (L)	6¾ in 171 mm	7¾ in 197 mm	7¾ in 197 mm	8⅝ in 219 mm	12 in 305 mm
Working (WL)	2¾ in 70 mm	3 in 76 mm	3⅝ in 92 mm	4½ in 114 mm	7⅞ in 200 mm

TIP SIZE	INSULATED	INSULATED	INSULATED	INSULATED	INSULATED
Micro	80205	80304			
0.5 mm	80204	80303	80434	80574	
0.75 mm			80433	80573	
1.0 mm	80202	80302			80582
1.2 mm			80432	80572	
1.5 mm	80201	80301	80431	80571	80581
2.0 mm	80200	80300	80430	80570	80580

Single-use products are sold sterile.
Kits Include Forceps, 12 ft (3.6 m) Cord and Surgi-Wipe.

Olsen®/Ultra™ Reusable Bayonet Bipolar Forceps



Bayonet Bipolar Forceps, Acute Angle

Reusable, Smooth Tips, 1 Each

Length (L)	6 1/8 in 156 mm	7 1/2 in 191 mm	8 3/8 in 213 mm	6 1/8 in 156 mm	7 1/2 in 191 mm	8 3/8 in 213 mm
Working (WL)	2 5/8 in 67 mm	2 3/4 in 70 mm	8 3/8 in 213 mm	2 5/8 in 67 mm	2 3/4 in 70 mm	8 3/8 in 213 mm

TIP SIZE	NON-INSULATED	NON-INSULATED	NON-INSULATED	INSULATED	INSULATED	INSULATED
1.0 mm	10-1501	10-1531	10-1561	10-1501I	10-1531I	10-1561I
1.5 mm	10-1511	10-1541	10-1571	10-1511I	10-1541I	10-1571I
2.0 mm	10-1521	10-1551	10-1581	10-1521I	10-1551I	10-1581I



Bayonet Bipolar Forceps, Angled Up

Reusable, Smooth Tips, 1 Each

Length (L)	8 1/4 in 210 mm	10 1/2 in 267 mm	8 1/4 in 210 mm	10 1/2 in 267 mm
Working (WL)	4 1/4 in 108 mm	6 1/4 in 159 mm	4 1/4 in 108 mm	6 1/4 in 159 mm

TIP SIZE	NON-INSULATED	NON-INSULATED	INSULATED	INSULATED
1.0 mm	10-1445	10-1482	10-1445I	10-1482I
1.5 mm	10-1447	10-1486	10-1447I	10-1486I
2.0 mm	10-1449	10-1488	10-1449I	10-1488I

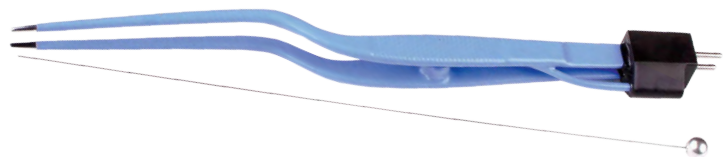

Bayonet Bipolar Forceps, Irrigating

Reusable, Smooth Tips, Insulated with Stylet, 1 Each

Length (L)	6 1/2 in 165 mm	7 3/4 in 197 mm	8 5/8 in 219 mm	10 1/2 in 267 mm
Working (WL)	2 3/4 in 70 mm	3 5/8 in 92 mm	4 3/8 in 111 mm	6 1/4 in 159 mm

TIP SIZE	INSULATED	INSULATED	INSULATED	INSULATED
0.5 mm		10-0351I	10-0401I	10-0461I
0.75 mm	10-0321I	10-0361I	10-0411I	10-0471I
1.0 mm	10-0331I	10-0371I	10-0421I	10-0481I
1.5 mm	10-0341I	10-0381I	10-0431I	10-0491I
2.0 mm		10-0391I	10-0441I	10-0493I

Single-use products are sold sterile.
Kits Include Forceps, 12 ft (3.6 m) Cord and Surgi-Wipe.

Questions? Contact us at customerservice@symmetrysurgical.com
or learn more at symmetrysurgical.com

Olsen®/Ultra™ Reusable Bayonet Bipolar Forceps

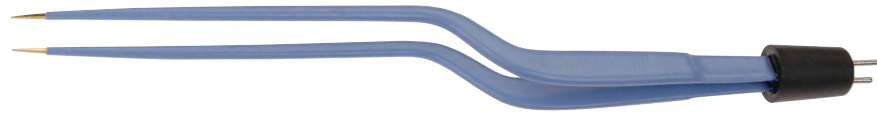

Bayonet Bipolar Forceps, with Midas Touch® Non-Stick Tips

Reusable, Smooth Tips, 1 Each

Length (L)	7¾ in 197 mm	8⅝ in 219 mm	10½ in 267 mm
Working (WL)	3⅝ in 92 mm	4⅜ in 111 mm	6¼ in 159 mm
TIP SIZE	INSULATED	INSULATED	INSULATED
0.5 mm	90-7004	90-8012	90-9008
0.75 mm	90-7000	90-8000	90-9007
1.2 mm	90-7005	90-8013	90-9006
1.5 mm	90-7001	90-8001	90-9005
2.0 mm	90-7006	90-8003	90-9009



Cushing Bayonet Bipolar Forceps

Reusable, Smooth Tips, 1 Each

CODE	DESCRIPTION	TIP SIZE	LENGTH
08-0000	Forceps, Non-Insulated	0.7 mm	7½ in 191 mm
08-0026	Forceps, Non-Insulated	1.0 mm	7½ in 191 mm
08-0027	Forceps, Non-Insulated	1.5 mm	7¾ in 197 mm
08-0000I	Forceps, Insulated	0.7 mm	7¾ in 197 mm
08-0026I	Forceps, Insulated	1.0 mm	7¾ in 197 mm
08-0027I	Forceps, Insulated	1.5 mm	7¾ in 197 mm

Cushing Bayonet Bipolar Forceps, Irrigating

Reusable, Smooth Tips, 1 Each

CODE	DESCRIPTION	TIP SIZE	LENGTH
08-0026IG	Irrigating, Insulated	1.0 mm	7½ in 191 mm



Gerald Bayonet Bipolar Forceps, Irrigating

Reusable, 1 Each

CODE	DESCRIPTION	TIP SIZE	LENGTH
08-0041	Non-Insulated	1.0 mm	7½ in 191 mm
08-0013IG	Insulated	1.0 mm	7¼ in 184 mm

Single-use products are sold sterile.
Kits Include Forceps, 12 ft (3.6 m) Cord and Surgi-Wipe.

Olsen®/Ultra™ Reusable Bayonet Bipolar Forceps



Hardy™ Bayonet Bipolar Forceps

Reusable, Smooth Tips, 1 Each

CODE	DESCRIPTION	TIP SIZE	LENGTH
08-0043	Forceps, Non-Insulated	0.5 mm	8 ½ in 216 mm
08-0043I	Forceps, Insulated	0.5 mm	8 ½ in 216 mm

K-Style Standard Acute Angle Bayonet Bipolar Forceps, Straight

Reusable, Smooth Tip, Midas Touch® Non-Stick Tips, 1 Each

Length (L)	8 ⅝ in 219 mm	9 ½ in 241 mm
Working (WL)	4 ½ in 114 mm	5 ⅛ in 130 mm
TIP SIZE	INSULATED	INSULATED
1.0 mm	90-8008	90-9504



K-Style Standard Angle Bayonet Bipolar Forceps, Straight

Reusable, Smooth Tip, Midas Touch® Non-Stick Tips, 1 Each

Length (L)	8 ⅝ in 219 mm	9 ½ in 241 mm	10 ½ in 267 mm
Working (WL)	4 ½ in 114 mm	5 ⅛ in 130 mm	6 ¼ in 159 mm
TIP SIZE	INSULATED	INSULATED	INSULATED
0.5 mm	90-8015	90-9507	
0.75 mm	90-8016	90-9508	
1.0 mm	90-8006	90-9501	90-9001
1.5 mm		90-9500	90-9000

Single-use products are sold sterile.
Kits Include Forceps, 12 ft (3.6 m) Cord and Surgi-Wipe.

Questions? Contact us at customerservice@symmetrysurgical.com
or learn more at symmetrysurgical.com

Olsen®/Ultra™ Reusable Bayonet Bipolar Forceps



K-Style Standard Angle Bayonet Bipolar Forceps, Curved Up

Reusable, Smooth Tip, Midas Touch® Non-Stick Tips, 1 Each

Length (L)	8 ⁵ / ₈ in 219 mm	9 ¹ / ₂ in 241 mm
Working (WL)	4 ¹ / ₂ in 114 mm	5 ¹ / ₈ in 130 mm
TIP SIZE	INSULATED	INSULATED
0.5 mm	90-8017	90-9509
0.75 mm	90-8018	90-9510
1.0 mm	90-8007	90-9502



K-Style Standard Angle Bayonet Bipolar Forceps, Curved Down

Reusable, Smooth Tip, Midas Touch® Non-Stick Tips, 1 Each

Length (L)	8 ⁵ / ₈ in 219 mm	9 ¹ / ₂ in 241 mm
Working (WL)	4 ¹ / ₂ in 114 mm	5 ¹ / ₈ in 130 mm
TIP SIZE	INSULATED	INSULATED
1.0 mm	90-9503	90-9506

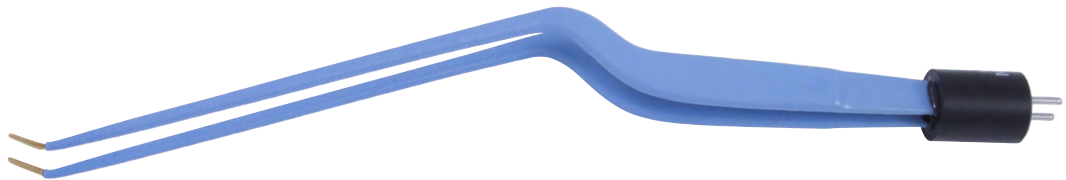

K-Style Standard Angle Bayonet Bipolar Forceps, Curved Up

Reusable, Smooth Tip, Midas Touch® Non-Stick Tips, 1 Each

Length (L)	8 ⁵ / ₈ in 219 mm	9 ¹ / ₂ in 241 mm
Working (WL)	4 ¹ / ₂ in 114 mm	5 ¹ / ₈ in 130 mm
TIP SIZE	INSULATED	INSULATED
1.0 mm	90-8009	90-9505

Single-use products are sold sterile.
Kits Include Forceps, 12 ft (3.6 m) Cord and Surgi-Wipe.

Olsen®/Ultra™ Reusable Bayonet Bipolar Forceps



Malis® Bayonet Bipolar Forceps

Reusable, 1 Each

CODE	DESCRIPTION	TIP SIZE	LENGTH
08-0090	Forceps, Non-Insulated	0.5 mm	5½ in 140 mm
08-0091	Forceps, Non-Insulated	1.5 mm	7 in 178 mm
08-0089	Forceps, Non-Insulated	1.5 mm	7½ in 191 mm

Malis® Bayonet Bipolar Forceps, Irrigating

Reusable, 1 Each

CODE	DESCRIPTION	TIP SIZE	LENGTH
08-0223	Forceps, Irrigating	0.25 mm	7½ in 191 mm
08-0143	Forceps, Irrigating	0.5 mm	7¾ in 197 mm
08-0149	Forceps, Irrigating	1.5 mm	8¾ in 222 mm



Rhoton® Bayonet Bipolar Forceps

Reusable, Round Handle, 1 Each

Length (L)	7½ in	181 mm	7⅞ in	200 mm	8⅝ in	219 mm	10 in	254 mm	7⅞ in	200 mm	8⅝ in	219 mm
TIP SIZE	NON-INSULATED	NON-INSULATED	NON-INSULATED	NON-INSULATED	INSULATED	INSULATED						
0.3 mm				08-0308								
0.5 mm			08-0303	08-0309								
0.7 mm				08-0310	08-0319	08-0304I	08-0310I					
1.0 mm	08-0300			08-0311			08-0311I					
1.5 mm			08-0306	08-0312		08-0306I	08-0312I					
2.0 mm	08-0301	08-0307	08-0313			08-0301I	08-0313I					

Rhoton® Bayonet Bipolar Forceps, Irrigating

Reusable, Round Handle, 1 Each

CODE	DESCRIPTION	TIP SIZE	LENGTH
08-0313IG	Irrigating Forceps, Insulated	2.0 mm	8⅝ in 219 mm

Single-use products are sold sterile.

Kits Include Forceps, 12 ft (3.6 m) Cord and Surgi-Wipe.

Questions? Contact us at customerservice@symmetrysurgical.com or learn more at symmetrysurgical.com

Olsen®/Ultra™ Reusable Bayonet Bipolar Forceps



Scoville-Greenwood Bayonet Bipolar Forceps

Reusable, 1 Each

CODE	DESCRIPTION	TIP SIZE	LENGTH	
08-0030	Forceps, Non-Insulated	1.5 mm	7 ½ in	191 mm
08-0092	Forceps, Non-Insulated	1.5 mm	7 in	178 mm
08-0028I	Forceps, Insulated	0.25 mm	7 ¾ in	197 mm
08-0030I	Forceps, Insulated	1.5 mm	7 ½ in	191 mm

Scoville-Greenwood Bayonet Bipolar Forceps, Irrigating

Reusable, 1 Each

CODE	DESCRIPTION	TIP SIZE	LENGTH	
08-0030IG	Irrigating, Insulated	1.5 mm	7 ¾ in	197 mm

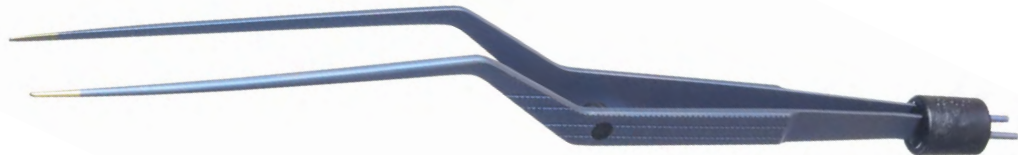

Titanium Bayonet Bipolar Forceps, Straight Tips

Reusable, Malis® Type, Flat Handle, 1 Each

CODE	DESCRIPTION	TIP SIZE	LENGTH	
08-0020	Forceps, Insulated	1.0 mm	8 ½ in	216 mm

Titanium Bayonet Bipolar Forceps, Tips Angled Down, Straight Tips

Reusable, Malis® Type, Flat Handle, 1 Each

CODE	DESCRIPTION	TIP SIZE	LENGTH	
08-0104	Forceps, Non-Insulated	0.5 mm	8 ¾ in	222 mm
08-0105I	Forceps, Insulated	0.5 mm	8 ¾ in	222 mm

Titanium Bayonet Bipolar Forceps, Irrigating

Reusable, Malis® Type, Flat Handle, 1 Each

CODE	DESCRIPTION	TIP SIZE	LENGTH	
08-0075	Forceps, Insulated	0.25 mm	8 ¾ in	222 mm
08-0100IG	Forceps, Insulated	0.5 mm	8 ¾ in	222 mm
08-0101IG	Forceps, Insulated	1.5 mm	8 ¾ in	222 mm

Single-use products are sold sterile.
Kits Include Forceps, 12 ft (3.6 m) Cord and Surgi-Wipe.

Olsen®/Ultra™ Reusable Bayonet Bipolar Forceps

Titanium Bayonet Bipolar Forceps, Straight Tips

Reusable, 1 Each

CODE	DESCRIPTION	TIP SIZE	LENGTH	
08-0100	Forceps, Non-Insulated	0.5 mm	8 ¾ in	222 mm
08-0101	Forceps, Non-Insulated	1.5 mm	8 ¾ in	222 mm
08-0100I	Forceps, Insulated	0.5 mm	8 ¾ in	222 mm
08-0101I	Forceps, Insulated	1.5 mm	8 ¾ in	222 mm

Titanium Bayonet Bipolar Forceps, with Midas Touch® Non-Stick Tips

Reusable, Straight, 1 Each

CODE	DESCRIPTION	TIP SIZE	LENGTH	
08-0062NS	Forceps, Non-Insulated	0.25 mm	8 ¾ in	222 mm



Titanium Rhoton® Bayonet Bipolar Forceps

Reusable, Round Handle, 1 Each

CODE	DESCRIPTION	TIP SIZE	LENGTH	
08-0122	Forceps, Non-Insulated	0.5 mm	9 ½ in	241 mm
08-0123	Forceps, Non-Insulated	1.0 mm	9 ½ in	241 mm
08-0122I	Forceps, Insulated	0.5 mm	9 ½ in	241 mm
08-0120I	Forceps, Insulated	1.5 mm	8 ½ in	216 mm

Titanium Rhoton® Bayonet Bipolar Forceps, Straight

Reusable, Round Handle, 1 Each

CODE	DESCRIPTION	TIP SIZE	LENGTH	
08-0058	Titanium Forceps	0.5 mm	6 in	152 mm
08-0130	Titanium Forceps	0.5 mm	7 in	178 mm
08-0509	Titanium Forceps	1.5 mm	8 ⅞ in	225 mm

Titanium Rhoton® Bayonet Bipolar Forceps, Curved

Reusable, Round Handle, 1 Each

CODE	DESCRIPTION	TIP SIZE	LENGTH	
08-0061	Titanium Forceps	0.5 mm	7 ⅞ in	181 mm

Single-use products are sold sterile.

Kits Include Forceps, 12 ft (3.6 m) Cord and Surgi-Wipe.

Questions? Contact us at customerservice@symmetrysurgical.com or learn more at symmetrysurgical.com

Olsen®/Ultra™ Reusable Bayonet Bipolar Forceps



Yasargil Bayonet Bipolar Forceps

Reusable, Flat Handle, 1 Each

CODE	DESCRIPTION	TIP SIZE	LENGTH
08-0015	Forceps, Non-Insulated	0.7 mm	6¼ in 159 mm
08-0016	Forceps, Non-Insulated	0.7 mm	6¼ in 159 mm
08-0017	Forceps, Non-Insulated	0.5 mm	7⅛ in 181 mm
08-0018	Forceps, Non-Insulated	0.7 mm	7⅛ in 181 mm
08-0019	Forceps, Non-Insulated	1.0 mm	7⅛ in 181 mm
08-0024	Forceps, Non-Insulated	1.3 mm	7⅛ in 181 mm
08-0022	Forceps, Non-Insulated	0.7 mm	7⅛ in 200 mm
08-0025	Forceps, Non-Insulated	1.3 mm	7⅛ in 200 mm
08-0023I	Forceps, Insulated	0.7 mm	7⅛ in 200 mm
08-0025I	Forceps, Insulated	1.3 mm	7⅛ in 200 mm



Yasargil Bayonet Bipolar Forceps, Irrigating

Reusable, Flat Handle, 1 Each

CODE	DESCRIPTION	TIP SIZE	LENGTH
08-0022IG	Forceps, Insulated	0.7 mm	7⅛ in 181 mm
08-0023IG	Forceps, Insulated	1.0 mm	7⅛ in 200 mm

Single-use products are sold sterile.
Kits Include Forceps, 12 ft (3.6 m) Cord and Surgi-Wipe.

Olsen®/Ultra™ Reusable Bayonet Bipolar Forceps

Adson Bipolar Forceps, Smooth Tip

Reusable, Smooth Tips, 1 Each

CODE	DESCRIPTION	TIP SIZE	LENGTH
08-0004	Forceps, Non-Insulated	1.0 mm	4 ¾ in 121 mm
10-1082	Forceps, Non-Insulated	1.0 mm	5 in 127 mm
08-0004I	Forceps, Insulated	1.0 mm	4 ¾ in 121 mm
10-1082I	Forceps, Insulated	1.0 mm	5 in 127 mm



Adson Bipolar Forceps, Smooth Tip, with Midas Touch® Non-Stick Tips

Reusable, 1 Each

CODE	DESCRIPTION	TIP SIZE	LENGTH
90-2001	Forceps, Insulated	0.5 mm	5 in 127 mm
90-2000	Forceps, Insulated	1.0 mm	5 in 127 mm



Adson Bipolar Forceps, Serrated Tip

Reusable, 1 Each

CODE	DESCRIPTION	TIP SIZE	LENGTH
10-1081	Forceps, Non-Insulated	1.0 mm	5 in 127 mm
10-1081I	Forceps, Insulated	1.0 mm	5 in 127 mm

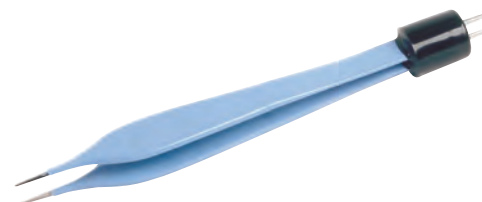

Adson Bipolar Forceps, Irrigating

Reusable, 1 Each

CODE	DESCRIPTION	TIP SIZE	LENGTH
10-0201I	Insulated, with Stylet	0.5 mm	5 in 127 mm
10-0200I	Insulated, with Stylet	1.0 mm	5 in 127 mm



Single-use products are sold sterile.
Kits Include Forceps, 12 ft (3.6 m) Cord and Surgi-Wipe.

Questions? Contact us at customerservice@symmetrysurgical.com
or learn more at symmetrysurgical.com

Olsen®/Ultra™ Reusable Bipolar Forceps

Coaption Bipolar Forceps

Reusable, 1 Each

CODE	DESCRIPTION	TIP SIZE	LENGTH
08-0008	Forceps, Non-Insulated	Micro	4¼ in 108 mm
08-0048	Forceps, Non-Insulated	0.4 mm	4¼ in 108 mm
10-1011	Forceps, Non-Insulated	Micro	4½ in 114 mm
10-1011I	Forceps, Insulated	Micro	4½ in 114 mm



Cushing Bipolar Forceps

Reusable, Smooth Tips, 1 Each

CODE	DESCRIPTION	TIP SIZE	LENGTH
10-1160	Forceps, Non-Insulated	1.0 mm	7¼ in 184 mm
10-1162	Forceps, Non-Insulated	1.5 mm	7¼ in 184 mm
08-0010	Forceps, Non-Insulated	1.5 mm	7⅛ in 181 mm
10-1160I	Forceps, Insulated	1.0 mm	7¼ in 184 mm
10-1162I	Forceps, Insulated	1.5 mm	7¼ in 184 mm

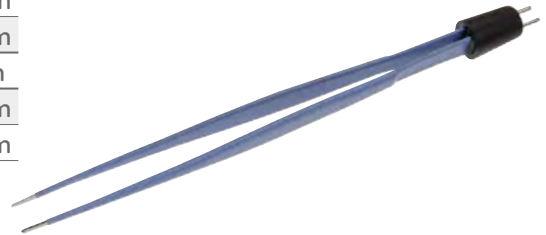

Gerald Bipolar Forceps

Reusable, Smooth Tips, 1 Each

CODE	DESCRIPTION	TIP SIZE	LENGTH
08-0012	Forceps, Non-Insulated	1.0 mm	7 in 178 mm
10-1180	Forceps, Non-Insulated	1.0 mm	7¼ in 184 mm
08-0013	Forceps, Non-Insulated	1.0 mm	7¼ in 184 mm
10-1180I	Forceps, Insulated	1.0 mm	7¼ in 184 mm

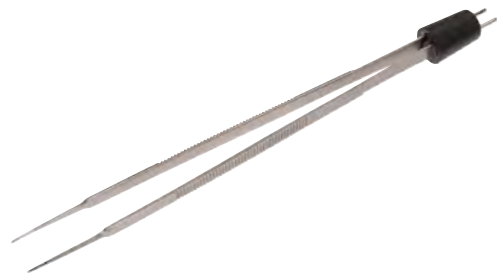

Replacement Stylets for Irrigating Bipolar Forceps

CODE	DESCRIPTION	LENGTH	QTY
08-1130	Accessory		12/Box
60-0300	Accessory	10¼ in 260 mm	5/Box

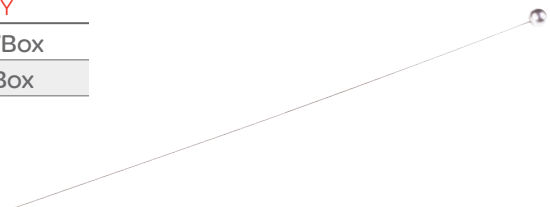

Single-use products are sold sterile.
Kits Include Forceps, 12 ft (3.6 m) Cord and Surgi-Wipe.

Questions? Contact us at customerservice@symmetrysurgical.com
or learn more at symmetrysurgical.com

Olsen®/Ultra™ Reusable Bipolar Forceps

Jewelers Bipolar Forceps

Reusable, Insulated, Smooth Tips, 1 Each

CODE	DESCRIPTION	TIP SIZE	LENGTH
80004	Forceps, Straight	Micro	4 ¼ in 108 mm
80003	Forceps, Straight	0.5 mm	4 ¼ in 108 mm
80002	Forceps, Straight	1.0 mm	4 ¼ in 108 mm
80001	Forceps, Straight	1.5 mm	4 ¼ in 108 mm
80000	Forceps, Straight	2.0 mm	4 ¼ in 108 mm
80104	Forceps, Curved	Micro	5 in 127 mm
80103	Forceps, Curved	0.5 mm	5 in 127 mm
80102	Forceps, Curved	1.0 mm	5 in 127 mm
80101	Forceps, Curved	1.5 mm	5 in 127 mm
80100	Forceps, Curved	2.0 mm	5 in 127 mm



Jewelers Bipolar Forceps

Reusable, Non-Insulated, Smooth Tips, 1 Each

CODE	DESCRIPTION	TIP SIZE	LENGTH
10-1061	Forceps, Straight	Micro	4 ½ in 114 mm
10-1062	Forceps, Straight	Blunt	4 ½ in 114 mm
08-0002	Forceps, Curved	0.4 mm	4 in 102 mm
08-0005	Forceps, Curved	0.4 mm	4 in 102 mm



Jewelers Bipolar Forceps

Reusable, Insulated, Smooth Tips, 1 Each

CODE	DESCRIPTION	TIP SIZE	LENGTH
10-1061I	Forceps, Straight	Micro	4 ½ in 114 mm
10-1062I	Forceps, Straight	Blunt	4 ½ in 114 mm
08-0001I	Forceps, Straight	0.4 mm	4 ½ in 114 mm



Jewelers Bipolar Forceps, with Midas Touch® Non-Stick Tips

Reusable, Smooth Tips, 1 Each

CODE	DESCRIPTION	TIP SIZE	LENGTH
90-1000	Forceps, Insulated	Micro	4 ⅝ in 117 mm

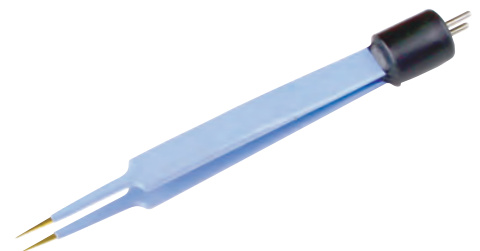

Single-use products are sold sterile.
Kits Include Forceps, 12 ft (3.6 m) Cord and Surgi-Wipe.

Questions? Contact us at customerservice@symmetrysurgical.com
or learn more at symmetrysurgical.com

Olsen®/Ultra™ Reusable Bipolar Forceps

Jewelers Bipolar Forceps, Ridged Handle, Angled

Reusable, Smooth Tips, 1 Each

CODE	DESCRIPTION	TIP SIZE	LENGTH
10-1202	Forceps, Non-Insulated	0.75 mm	4 ½ in 114 mm
10-1202I	Forceps, Insulated	0.75 mm	4 ½ in 114 mm

Jewelers Bipolar Forceps, Ridged Handle, Straight

Reusable, Smooth Tips, 1 Each

CODE	DESCRIPTION	TIP SIZE	LENGTH
10-1203	Forceps, Non-Insulated	Micro	3 ⅞ in 99 mm
10-1203I	Forceps, Insulated	Micro	3 ⅞ in 99 mm



McPherson Bipolar Forceps, Angled

Reusable, Smooth Tips, 1 Each

CODE	DESCRIPTION	TIP SIZE	LENGTH
08-0007	Forceps, Non-Insulated	0.5 mm	3 ¾ in 95 mm
10-1200	Forceps, Non-Insulated	0.5 mm	3 ⅞ in 99 mm
10-1021	Forceps, Non-Insulated	0.5 mm	4 in 102 mm
08-0007I	Forceps, Insulated	0.5 mm	3 ¾ in 95 mm
10-1200I	Forceps, Insulated	0.5 mm	3 ⅞ in 99 mm
10-1021I	Forceps, Insulated	0.5 mm	4 in 102 mm



McPherson Bipolar Forceps, Straight

Reusable, Smooth Tips, 1 Each

CODE	DESCRIPTION	TIP SIZE	LENGTH
10-1201	Forceps, Non-Insulated	0.5 mm	3 ⅞ in 99 mm
10-1201I	Forceps, Insulated	0.5 mm	3 ⅞ in 99 mm



Potts-Smith Bipolar Forceps

Reusable, Smooth Tips, 1 Each

CODE	DESCRIPTION	TIP SIZE	LENGTH
80404	Forceps, Insulated	Micro	7 ½ in 191 mm
80403	Forceps, Insulated	0.5 mm	7 ½ in 191 mm
80402	Forceps, Insulated	1.0 mm	7 ½ in 191 mm
80401	Forceps, Insulated	1.5 mm	7 ½ in 191 mm
80400	Forceps, Insulated	2.0 mm	7 ½ in 191 mm

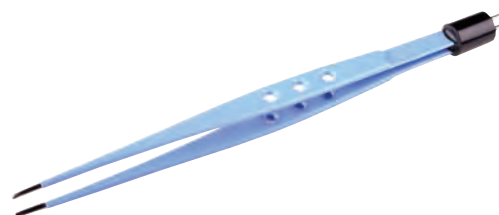

Single-use products are sold sterile.
Kits Include Forceps, 12 ft (3.6 m) Cord and Surgi-Wipe.

Olsen®/Ultra™ Reusable Bipolar Forceps

Semkin Bipolar Forceps

Reusable, Smooth Tips, 1 Each

CODE	DESCRIPTION	TIP SIZE	LENGTH
10-1091	Forceps, Non-Insulated	0.75 mm	5 ¾ in 146 mm
10-1191	Forceps, Non-Insulated	1.0 mm	5 ¾ in 146 mm
10-1091I	Forceps, Insulated	0.75 mm	5 ¾ in 146 mm
10-1191I	Forceps, Insulated	1.0 mm	5 ¾ in 146 mm



Semkin Bipolar Forceps, with Midas Touch® Non-Stick Tips

Reusable, Smooth Tips, 1 Each

CODE	DESCRIPTION	TIP SIZE	LENGTH
90-3000	Forceps, Insulated	0.75 mm	5 ¾ in 146 mm

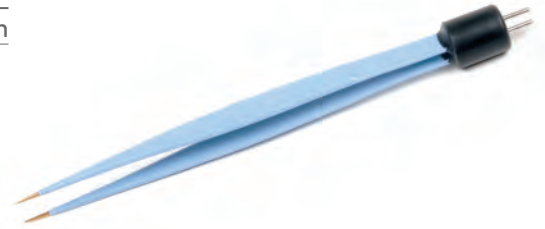

Titanium Jewelers Bipolar Forceps

Reusable, 1 Each

CODE	DESCRIPTION	TIP SIZE	LENGTH
08-0052	30° Tip	0.4 mm	3 ½ in 89 mm
08-0056	90° Tip	0.4 mm	4 ¼ in 108 mm

Titanium Jewelers Bipolar Forceps, Curved

Reusable, 1 Each

CODE	DESCRIPTION	TIP SIZE	LENGTH
08-0053	Titanium Forceps	0.4 mm	3 ½ in 89 mm

Titanium Jewelers Bipolar Forceps, Straight

Reusable, 1 Each

CODE	DESCRIPTION	TIP SIZE	LENGTH
08-0054	Titanium Forceps	0.4 mm	3 ½ in 89 mm
08-0057	Titanium Forceps	0.4 mm	4 ¼ in 108 mm

Single-use products are sold sterile.

Kits Include Forceps, 12 ft (3.6 m) Cord and Surgi-Wipe.

Questions? Contact us at customerservice@symmetrysurgical.com or learn more at symmetrysurgical.com

Olsen® Single-Use Monopolar Forceps



20-2650K



20-2920HK/20-2960HK

Monopolar Forceps

Single-Use, Insulated, Serrated Tips, Uses 960 Series Adapter, 10 per Box

Length (L)	8 in 203 mm	8 ½ in 216 mm	8 ¼ in 210 mm	7 ½ in 191 mm
Working (WL)		4 ⅛ in 105 mm	4 ¼ in 108 mm	3 in 76 mm
Tip Style	Straight	Straight	Straight	Cathedral
Forceps Style	Potts-Smith	Bayonet	Bayonet	Bayonet

TIP SIZE	FOOT-ACTIVATED ¹	FOOT-ACTIVATED ¹	HAND-CONTROLLED ²	HAND-CONTROLLED ²
1.5 mm	20-2650K	20-2920K	20-2920HK	20-2960HK

¹Foot-activated forceps include a 10 ft (3.0m) attached cord with crimped wire generator end.
²Hand-controlled forceps include 10 ft (3.0m) attached cord with molded generator plug.

Single-use products are sold sterile.
 Kits Include Forceps, 12 ft (3.6 m) Cord and Surgi-Wipe.

Olsen® Reusable Bayonet Monopolar Forceps

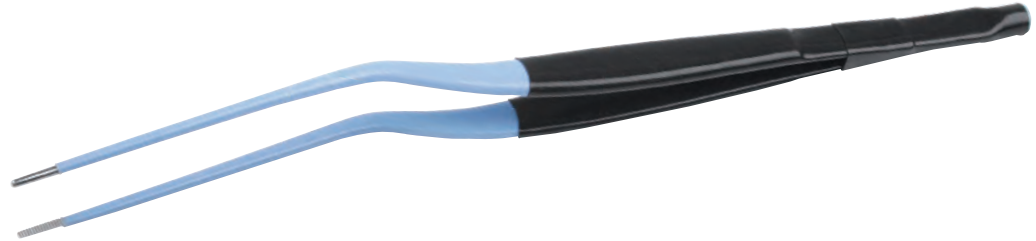

Bayonet Monopolar Forceps, Foot-Activated, Straight

Reusable, Threaded Connector, Serrated Tips, 1 Each

Length (L)	6¾ in 171 mm	7¾ in 197 mm	8 in 203 mm	8½ in 216 mm
Working (WL)	3⅛ in 79 mm	3⅞ in 99 mm	3 in 76 mm	4¾ in 121 mm
TIP SIZE	INSULATED	INSULATED	INSULATED	INSULATED
0.5 mm	41103	41203	41403	41605
1.0 mm	41102	41202	41402	41604
1.5 mm	41101	41201	41401	41602
2.0 mm	41100	41200	41400	41601

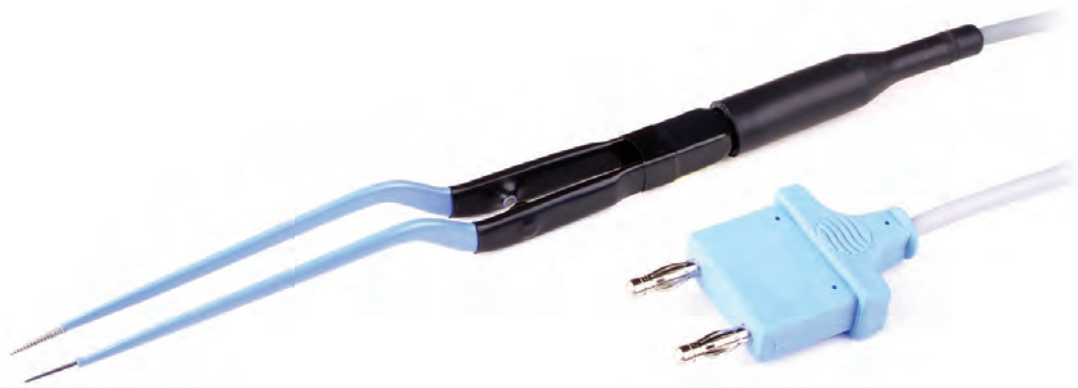

Bayonet Monopolar Forceps, Hand-Controlled

Reusable, Serrated Tips, Insulated with 10 ft (3.0 m) Attached Cord, 1 Each

Length (L)	6½ in 165 mm	8¼ in 210 mm	7½ in 191 mm	7½ in 191 mm
Working (WL)	3¼ in 83 mm	3½ in 89 mm	3¾ in 95 mm	3¾ in 95 mm
TIP SIZE	SERRATED TIP	SERRATED TIP	STRAIGHT	CATHEDRAL
0.5 mm	11104	11605	11206	11213
1.0 mm	11102	11604	11205	11212
1.5 mm	11101	11602	11204	11210
2.0 mm	11100	11600	11200	11208

Single-use products are sold sterile.

Kits Include Forceps, 12 ft (3.6 m) Cord and Surgi-Wipe.

Questions? Contact us at customerservice@symmetrysurgical.com or learn more at symmetrysurgical.com

Olsen® Reusable Bayonet Monopolar Forceps

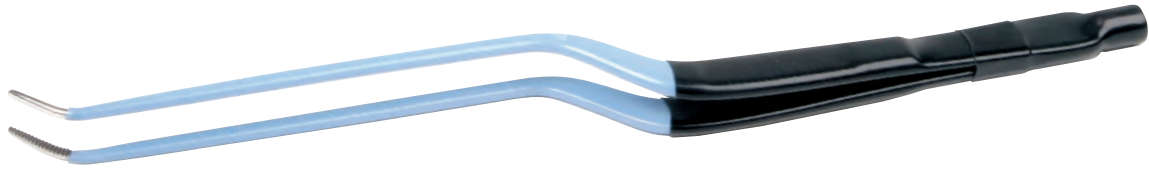

Bayonet Monopolar Forceps, Foot-Activated, Curved Up

Reusable, Threaded Connector, Serrated Tips, 1 Each

Length (L)	7¾ in 197 mm	8½ in 216 mm
Working (WL)	3⅞ in 99 mm	4¾ in 121 mm

TIP SIZE	INSULATED	INSULATED
0.5 mm	41302	41703
1.0 mm	41304	41702
1.5 mm	41301	41701
2.0 mm	41300	41700

Product Complaint? Call 800-251-3000

Patient safety is our #1 priority. We are committed to delivering exceptional quality and service. Compliance with domestic and international medical device regulations is strictly maintained at all times.

Product complaints are addressed promptly by our Complaint Handling Team. Contact Customer Service and request a Return Material Authorization (RMA) to begin the investigation process. Please return the instrument (with the original package and label – if available) along with the RMA form.

A representative will contact you within 48 hours of receiving the returned instrument with details regarding the steps we will take to ensure you and your patients are satisfied with the instruments you purchase from us.



Single-use products are sold sterile.
Kits Include Forceps, 12 ft (3.6 m) Cord and Surgi-Wipe.

Questions? Contact us at customerservice@symmetrysurgical.com
or learn more at symmetrysurgical.com

Olsen® Reusable Monopolar Forceps

Adson Monopolar Forceps, Hand-Controlled

Reusable, Serrated Tips, Insulated, 1 Each

CODE	DESCRIPTION	TIP SIZE	LENGTH
12204	10 ft (3.0 m) Attached Cord	Micro	4 ¾ in 121 mm
12203	10 ft (3.0 m) Attached Cord	0.5 mm	4 ¾ in 121 mm
12202	10 ft (3.0 m) Attached Cord	1.0 mm	4 ¾ in 121 mm
12200	10 ft (3.0 m) Attached Cord	2.0 mm	4 ¾ in 121 mm



Adson Monopolar Forceps, Foot-Controlled

Reusable, Threaded Connector, Serrated Tips, Insulated, 1 Each

CODE	DESCRIPTION	TIP SIZE	LENGTH
42505	Monopolar Forceps, Insulated	0.5 mm	5 ¼ in 133 mm
42503	Monopolar Forceps, Insulated	1.0 mm	5 ¼ in 133 mm
42502	Monopolar Forceps, Insulated	1.5 mm	5 ¼ in 133 mm
42500	Monopolar Forceps, Insulated	2.0 mm	5 ¼ in 133 mm



Cushing Monopolar Forceps, Hand-Controlled

Reusable, Serrated Tips, Insulated, 1 Each

CODE	DESCRIPTION	TIP SIZE	LENGTH
12103	10 ft (3.0 m) Attached Cord	0.5 mm	7 in 178 mm
12102	10 ft (3.0 m) Attached Cord	1.0 mm	7 in 178 mm
12101	10 ft (3.0 m) Attached Cord	1.5 mm	7 in 178 mm
12100	10 ft (3.0 m) Attached Cord	2.0 mm	7 in 178 mm

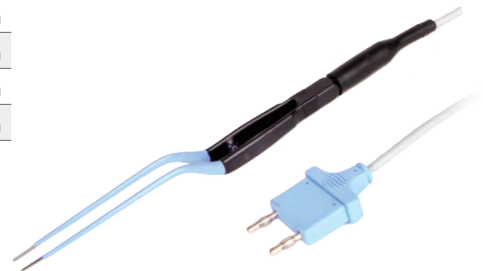

Jewelers Monopolar Forceps, Foot-Activated

Reusable, Threaded Connector, Serrated Tips, Insulated, 1 Each

CODE	DESCRIPTION	TIP SIZE	LENGTH
43104	Insulated, Straight	Micro	4 ¾ in 121 mm
43110	Insulated, Straight	Micro	4 ¾ in 121 mm
43103	Insulated, Straight	0.5 mm	4 ¾ in 121 mm
43109	Insulated, Straight	0.5 mm	4 ¾ in 121 mm
43204	Insulated, Curved	Micro	4 ¾ in 121 mm
43203	Insulated, Curved	0.5 mm	4 ¾ in 121 mm



Single-use products are sold sterile.
Kits Include Forceps, 12 ft (3.6 m) Cord and Surgi-Wipe.

Questions? Contact us at customerservice@symmetrysurgical.com
or learn more at symmetrysurgical.com

Olsen® Reusable Monopolar Forceps

Potts-Smith Monopolar Forceps, Hand-Controlled

Reusable, Serrated Tips, Insulated, 1 Each

CODE	DESCRIPTION	TIP SIZE	LENGTH
11804	10 ft (3.0 m) Attached Cord	0.5 mm	7 in 178 mm
11803	10 ft (3.0 m) Attached Cord	1.0 mm	7 in 178 mm
11802	10 ft (3.0 m) Attached Cord	1.5 mm	7 in 178 mm
11800	10 ft (3.0 m) Attached Cord	2.0 mm	7 in 178 mm
11906	10 ft (3.0 m) Attached Cord	0.5 mm	8¼ in 210 mm
11904	10 ft (3.0 m) Attached Cord	1.0 mm	8¼ in 210 mm
11903	10 ft (3.0 m) Attached Cord	1.5 mm	8¼ in 210 mm
11901	10 ft (3.0 m) Attached Cord	2.0 mm	8¼ in 210 mm
12000	10 ft (3.0 m) Attached Cord	2.0 mm	9½ in 241 mm
12003	10 ft (3.0 m) Attached Cord	1.5 mm	9½ in 241 mm
12004	10 ft (3.0 m) Attached Cord	1.0 mm	9½ in 241 mm
12005	10 ft (3.0 m) Attached Cord	0.5 mm	9½ in 241 mm



Potts-Smith Monopolar Forceps, Foot-Controlled

Reusable, Serrated Tips, Insulated, 1 Each

CODE	TIP SIZE	LENGTH
42203	0.5 mm	7½ in 191 mm
42202	1.0 mm	7½ in 191 mm
42201	1.5 mm	7½ in 191 mm
42200	2.0 mm	7½ in 191 mm
42304	0.5 mm	8½ in 216 mm
42302	1.0 mm	8½ in 216 mm
42301	1.5 mm	8½ in 216 mm
42300	2.0 mm	8½ in 216 mm
42405	0.5 mm	9¾ in 248 mm
42404	1.0 mm	9¾ in 248 mm
42402	1.5 mm	9¾ in 248 mm
42400	2.0 mm	9¾ in 248 mm



Single-use products are sold sterile.
Kits Include Forceps, 12 ft (3.6 m) Cord and Surgi-Wipe.

Olsen® Monopolar Electrodes



1/8 in (3.2 mm) Ball



3/16 in (4.8 mm) Ball

Ball Electrodes, 1/8 in (3.2 mm) Ball

Reusable, Straight, 1 Each

CODE	DESCRIPTION	LENGTH
66200	Straight Ball Electrode	2 in 51 mm
66214	Straight Ball Electrode	3 in 76 mm
66202	Straight Ball Electrode	4 in 102 mm
66204	Straight Ball Electrode	5 in 127 mm
66212	Straight Ball Electrode	5 ½ in 140 mm
66206	Straight Ball Electrode	6 in 152 mm
66208	Straight Ball Electrode	7 in 178 mm
66210	Straight Ball Electrode	8 in 203 mm

Ball Electrodes, 3/16 in (4.8 mm) Ball

Reusable, Straight, 1 Each

CODE	DESCRIPTION	LENGTH
66201	Straight Ball Electrode	2 in 51 mm
66215	Straight Ball Electrode	3 in 76 mm
66203	Straight Ball Electrode	4 in 102 mm
66205	Straight Ball Electrode	5 in 127 mm
66213	Straight Ball Electrode	5 ½ in 140 mm
66207	Straight Ball Electrode	6 in 152 mm
66209	Straight Ball Electrode	7 in 178 mm
66211	Straight Ball Electrode	8 in 203 mm

Ball Electrodes

Single-Use, Straight

CODE	DESCRIPTION	LENGTH	QTY
97200	Straight Ball Electrode	2 ¾ in 70 mm	50
97201	Straight Ball Electrode	5 in 127 mm	25



Ball Electrodes, with Midas Touch® Non-Stick

Single-Use, Straight

CODE	DESCRIPTION	LENGTH	QTY
30-2001	Straight Ball Electrode	2 ¾ in 70 mm	10
30-2003	Straight Ball Electrode	5 in 127 mm	10

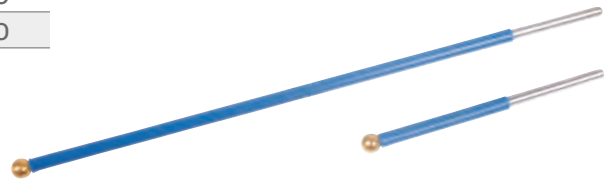

Blade Electrodes, Straight

Reusable, Standard 10 mm Exposure, 1 Each

CODE	DESCRIPTION	LENGTH
66000	Straight Electrode	2 ¾ in 70 mm
66001	Straight Electrode	4 in 102 mm
66002	Straight Electrode	5 in 127 mm
66003	Straight Electrode	6 in 152 mm
66004	Straight Electrode	7 in 178 mm
66005	Straight Electrode	8 in 203 mm



Single-use products are sold sterile.

Kits Include Forceps, 12 ft (3.6 m) Cord and Surgi-Wipe.

Questions? Contact us at customerservice@symmetrysurgical.com or learn more at symmetrysurgical.com

Olsen® Monopolar Electrodes

Blade Electrodes, Angled

Reusable, Standard 10 mm Exposure, 1 Each

CODE	DESCRIPTION	LENGTH	
66006	Angled Electrode	2¾ in	70 mm
66007	Angled Electrode	4 in	102 mm
66008	Angled Electrode	5 in	127 mm
66009	Angled Electrode	6 in	152 mm
66010	Angled Electrode	7 in	178 mm
66011	Angled Electrode	8 in	203 mm
66014	Angled Electrode	11 in	279 mm



Blade Electrodes, Short/Close-Up

Reusable, Standard 10 mm Exposure, 1 Each

CODE	DESCRIPTION	LENGTH	
66700	Stainless Steel Standard Blade	2 in	51 mm
66704	Stainless Steel Blunt Blade	2 in	51 mm
66703	Stainless Steel Modified Blade	2½ in	64 mm
66705	Titanium Standard Blade	2½ in	64 mm



Blade Electrodes, Straight

Reusable, 1 Each

CODE	DESCRIPTION	LENGTH		EXPOSURE
68000	Straight Electrode	2¾ in	70 mm	2.0 mm
68001	Straight Electrode	2¾ in	70 mm	3.0 mm
68003	Straight Electrode	2¾ in	70 mm	5.0 mm
68002	Straight Electrode	4 in	102 mm	2.0 mm
68004	Straight Electrode	4 in	102 mm	6.0 mm
68006	Straight Electrode	4½ in	114 mm	2.0 mm
68005	Straight Electrode	6 in	152 mm	2.0 mm



Single-use products are sold sterile.
Kits Include Forceps, 12 ft (3.6 m) Cord and Surgi-Wipe.

Olsen® Monopolar Electrodes

Nasal Needle Electrode

Reusable, 1 Each

CODE	DESCRIPTION	LENGTH
68603	6.0 mm Exposure	8 in 203 mm
68601	15 mm Exposure	8 in 203 mm
68602	50 mm Exposure	8 in 203 mm
68600	102 mm Exposure	8 in 203 mm



Laparoscopic Monopolar Electrode

Reusable

CODE	DESCRIPTION	LENGTH
90-9522	L-Hook	12½in 320 mm
90-9523	Spatula	12½in 320 mm
90-9525	J-Hook	12½in 320 mm
90-9526	Needle	12½in 320 mm
90-9527	Button Tip	12½in 320 mm



Laparoscopic Monopolar Suction/Irrigation Electrode

Reusable, 5.0 mm Shaft, with Valve, Fully Insulated

CODE	DESCRIPTION	LENGTH
90-4005	J-Hook	12½in 320 mm
90-4010	Button Tip	12½in 320 mm
90-4012	L-Hook	12½in 320 mm
90-4015	Spatula	12½in 320 mm

Single-use products are sold sterile.
Kits Include Forceps, 12 ft (3.6 m) Cord and Surgi-Wipe.

Questions? Contact us at customerservice@symmetrysurgical.com
or learn more at symmetrysurgical.com

Monopolar Electrodes

Rectal Snare

Insulated

CODE	DESCRIPTION	LENGTH
50-9731	Monopolar Instrument, Bayonet Shape	11 ³ / ₄ in 298 mm



Wire Loop for Rectal Snare

CODE	DESCRIPTION	LENGTH
50-9749	Loop Electrode	11 ³ / ₄ in 298 mm



Claw Grasper

Direct Drive, Monopolar Laparoscopy Forceps, 5.0 mm , Insulated

CODE	DESCRIPTION	LENGTH
94-1005L-26	Locking Handle	10 ¹ / ₄ in 26 cm
94-1005L	Locking Handle	13 in 33 cm
94-1005L-45	Locking Handle	17 ³ / ₄ in 45 cm

Dolphin Nose Dissector

Direct Drive, Monopolar Laparoscopy Forceps, 5.0 mm, Insulated

CODE	DESCRIPTION	LENGTH
94-1030-26	Non-Locking Handle	10 ¹ / ₄ in 26 cm
94-1030	Non-Locking Handle	13 in 33 cm
94-1030-45	Non-Locking Handle	17 ³ / ₄ in 45 cm

Single-use products are sold sterile.
Kits Include Forceps, 12 ft (3.6 m) Cord and Surgi-Wipe.

Ultra™ Monopolar Laparoscopic Forceps

Grasper

Direct Drive, Monopolar Laparoscopy Forceps, 5.0 mm, Insulated

CODE	DESCRIPTION	LENGTH
94-1032L-26	Locking Handle	10 ¼ in 26 cm
94-1032L	Locking Handle	13 in 33 cm
94-1032L-45	Locking Handle	17 ¾ in 45 cm
94-1032-26	Non-Locking Handle	10 ¼ in 26 cm
94-1032	Non-Locking Handle	13 in 33 cm
94-1032-45	Non-Locking Handle	17 ¾ in 45 cm



Bullet Nose Dissector

Monopolar Laparoscopy Forceps, 5.0 mm, Insulated

CODE	DESCRIPTION	LENGTH
94-1033L-26	Locking Handle	10 ¼ in 26 cm
94-1033L	Locking Handle	13 in 33 cm
94-1033L-45	Locking Handle	17 ¾ in 45 cm
94-1033-26	Non-Locking Handle	10 ¼ in 26 cm
94-1033	Non-Locking Handle	13 in 33 cm
94-1033-45	Non-Locking Handle	17 ¾ in 45 cm



Dolphin Nose Grasper

Monopolar Laparoscopy Forceps, 5.0 mm, Insulated

CODE	DESCRIPTION	LENGTH
94-1034-26	Non-Locking Handle	10 ¼ in 26 cm
94-1034	Non-Locking Handle	13 in 33 cm
94-1034-45	Non-Locking Handle	17 ¾ in 45 cm



Single-use products are sold sterile.
Kits Include Forceps, 12 ft (3.6 m) Cord and Surgi-Wipe.

Questions? Contact us at customerservice@symmetrysurgical.com
or learn more at symmetrysurgical.com

Ultra™ Monopolar Laparoscopic Forceps

Cup Tooth Grasper

Direct Drive, Monopolar Laparoscopy Forceps, 5.0 mm, Insulated

CODE	DESCRIPTION	LENGTH
94-1035L-26	Locking Handle	10 ¼ in 26 cm
94-1035L	Locking Handle	13 in 33 cm
94-1035L-45	Locking Handle	17 ¾ in 45 cm
94-1035-26	Non-Locking Handle	10 ¼ in 26 cm
94-1035	Non-Locking Handle	13 in 33 cm
94-1035-45	Non-Locking Handle	17 ¾ in 45 cm
94-1035SL-26	Slidelock Handle	10 ¼ in 26 cm
94-1035SL	Slidelock Handle	13 in 33 cm
94-1035SL-45	Slidelock Handle	17 ¾ in 45 cm



Micro Fenestrated Grasper

Direct Drive, Monopolar Laparoscopy Forceps, 5.0 mm, Insulated

CODE	DESCRIPTION	LENGTH
94-1044-26	Non-Locking Handle	10 ¼ in 26 cm
94-1044	Non-Locking Handle	13 in 33 cm
94-1044-45	Non-Locking Handle	17 ¾ in 45 cm



Needle Nose Dissector

Direct Drive, Monopolar Laparoscopy Forceps, 5.0 mm, Insulated

CODE	DESCRIPTION	LENGTH
94-1045-26	Non-Locking Handle	10 ¼ in 26 cm
94-1045	Non-Locking Handle	13 in 33 cm
94-1045-45	Non-Locking Handle	17 ¾ in 45 cm

Ultra™ Monopolar Laparoscopic Forceps

Fundus Tri-Max Grasper

Monopolar Laparoscopy Forceps, 5.0 mm, Insulated

CODE	DESCRIPTION	LENGTH
94-1050L-26	Locking Handle	10 ¼ in 26 cm
94-1050L	Locking Handle	13 in 33 cm
94-1050L-45	Locking Handle	17 ¾ in 45 cm

Wave Grasper

Direct Drive, Monopolar Laparoscopy Forceps, 5.0 mm, Insulated

CODE	DESCRIPTION	LENGTH
94-1051L-26	Locking Handle	10 ¼ in 26 cm
94-1051L	Locking Handle	13 in 33 cm
94-1051L-45	Locking Handle	17 ¾ in 45 cm
94-1051-26	Non-Locking Handle	10 ¼ in 26 cm
94-1051	Non-Locking Handle	13 in 33 cm
94-1051-45	Non-Locking Handle	17 ¾ in 45 cm



Alligator Grasper

Direct Drive, Monopolar Laparoscopy Forceps, 5.0 mm, Insulated

CODE	DESCRIPTION	LENGTH
94-1052L-26	Locking Handle	10 ¼ in 26 cm
94-1052L	Locking Handle	13 in 33 cm
94-1052L-45	Locking Handle	17 ¾ in 45 cm

Single-use products are sold sterile.
Kits Include Forceps, 12 ft (3.6 m) Cord and Surgi-Wipe.

Questions? Contact us at customerservice@symmetrysurgical.com
or learn more at symmetrysurgical.com

Ultra™ Monopolar Laparoscopic Forceps

Atraumatic Grasper

Direct Drive, Monopolar Laparoscopy Forceps, 5.0 mm, Insulated

CODE	DESCRIPTION	LENGTH
94-1053L-26	Locking Handle	10 ¼ in 26 cm
94-1053L	Locking Handle	13 in 33 cm
94-1053L-45	Locking Handle	17 ¾ in 45 cm
94-1053SL-26	Slidelock Handle	10 ¼ in 26 cm
94-1053SL	Slidelock Handle	13 in 33 cm
94-1053SL-45	Slidelock Handle	17 ¾ in 45 cm



Retraction Grasper

Monopolar Laparoscopy Forceps, 5.0 mm, Insulated

CODE	DESCRIPTION	LENGTH
94-1056L-26	Locking Handle	10 ¼ in 26 cm
94-1056L	Locking Handle	13 in 33 cm
94-1056L-45	Locking Handle	17 ¾ in 45 cm
94-1056-26	Non-Locking Handle	10 ¼ in 26 cm
94-1056	Non-Locking Handle	13 in 33 cm
94-1056-45	Non-Locking Handle	17 ¾ in 45 cm



Right Angle Dissector

Direct Drive, Monopolar Laparoscopy Forceps, 5.0 mm, Insulated

CODE	DESCRIPTION	LENGTH
94-1063-26	Non-Locking Handle	10 ¼ in 26 cm
94-1063	Non-Locking Handle	13 in 33 cm
94-1063-45	Non-Locking Handle	17 ¾ in 45 cm



Single-use products are sold sterile.
Kits Include Forceps, 12 ft (3.6 m) Cord and Surgi-Wipe.

Ultra™ Monopolar Laparoscopic Forceps

Soft Curve Dissector

Direct Drive, Monopolar Laparoscopy Forceps, 5.0 mm, Insulated

CODE	DESCRIPTION	LENGTH
94-1064-26	Non-Locking Handle	10 ¼ in 26 cm
94-1064	Non-Locking Handle	13 in 33 cm
94-1064-45	Non-Locking Handle	17 ¾ in 45 cm



Mixer Right Angle Dissector

Direct Drive, Monopolar Laparoscopy Forceps, 5.0 mm, Insulated

CODE	DESCRIPTION	LENGTH
94-1066-26	Non-Locking Handle	10 ¼ in 26 cm
94-1066	Non-Locking Handle	13 in 33 cm
94-1066-45	Non-Locking Handle	17 ¾ in 45 cm



Maryland Dissector

Direct Drive, Monopolar Laparoscopy Forceps, 5.0 mm, Insulated

CODE	DESCRIPTION	LENGTH
94-1067L-26	Locking Handle	10 ¼ in 26 cm
94-1067L	Locking Handle	13 in 33 cm
94-1067L-45	Locking Handle	17 ¾ in 45 cm
94-1067-26	Non-Locking Handle	10 ¼ in 26 cm
94-1067	Non-Locking Handle	13 in 33 cm
94-1067-45	Non-Locking Handle	17 ¾ in 45 cm

Single-use products are sold sterile.
Kits Include Forceps, 12 ft (3.6 m) Cord and Surgi-Wipe.

Questions? Contact us at customerservice@symmetrysurgical.com
or learn more at symmetrysurgical.com

Ultra™ Monopolar Laparoscopic Forceps

Cobra Tooth Grasper

Direct Drive, Monopolar Laparoscopy Forceps, 5.0 mm, Insulated

CODE	DESCRIPTION	LENGTH
94-1069L-26	Locking Handle	10 ¼ in 26 cm
94-1069L	Locking Handle	13 in 33 cm
94-1069L-45	Locking Handle	17 ¾ in 45 cm



Allis Grasper

Direct Drive, Monopolar Laparoscopy Forceps, 5.0 mm, Insulated

CODE	DESCRIPTION	LENGTH
94-1078L-26	Locking Handle	10 ¼ in 26 cm
94-1078L	Locking Handle	13 in 33 cm
94-1078L-45	Locking Handle	17 ¾ in 45 cm
94-1078SL-26	Slidelock Handle	10 ¼ in 26 cm
94-1078SL	Slidelock Handle	13 in 33 cm
94-1078SL-45	Slidelock Handle	17 ¾ in 45 cm



Allis Single Grasper

Direct Drive, Monopolar Laparoscopy Forceps, 5.0 mm, Insulated

CODE	DESCRIPTION	LENGTH
94-1088L-26	Locking Handle	10 ¼ in 26 cm
94-1088L	Locking Handle	13 in 33 cm
94-1088L-45	Locking Handle	17 ¾ in 45 cm

Babcock Grasper

Direct Drive, Monopolar Laparoscopy Forceps, 5.0 mm, Insulated

CODE	DESCRIPTION	LENGTH
94-1089L-26	Locking Handle	10 ¼ in 26 cm
94-1089L	Locking Handle	13 in 33 cm
94-1089L-45	Locking Handle	17 ¾ in 45 cm
94-1089SL-26	Slidelock Handle	10 ¼ in 26 cm
94-1089SL	Slidelock Handle	13 in 33 cm
94-1089SL-45	Slidelock Handle	17 ¾ in 45 cm



Single-use products are sold sterile.
Kits Include Forceps, 12 ft (3.6 m) Cord and Surgi-Wipe.

Ultra™ Monopolar Laparoscopic Forceps

DeBakey Grasper

Direct Drive, Monopolar Laparoscopy Forceps, 5.0 mm, Insulated

CODE	DESCRIPTION	LENGTH
94-1091-26	Locking Handle	10 ¼ in 26 cm
94-1091	Locking Handle	13 in 33 cm
94-1091-45	Locking Handle	17 ¾ in 45 cm



DeBakey Grasper

Direct Drive, Monopolar Laparoscopy Forceps, 5.0 mm, Insulated

CODE	DESCRIPTION	LENGTH
94-1091L-26	Locking Handle	10 ¼ in 26 cm
94-1091L	Locking Handle	13 in 33 cm
94-1091L-45	Locking Handle	17 ¾ in 45 cm
94-1091SL-26	Slidelock Handle	10 ¼ in 26 cm
94-1091SL	Slidelock Handle	13 in 33 cm
94-1091SL-45	Slidelock Handle	17 ¾ in 45 cm



DeBakey Long Grasper

Direct Drive, Monopolar Laparoscopy Forceps, 5.0 mm, Insulated

CODE	DESCRIPTION	LENGTH
94-1092L-26	Locking Handle	10 ¼ in 26 cm
94-1092L	Locking Handle	13 in 33 cm
94-1092L-45	Locking Handle	17 ¾ in 45 cm
94-1092SL-26	Slidelock Handle	10 ¼ in 26 cm
94-1092SL	Slidelock Handle	13 in 33 cm
94-1092SL-45	Slidelock Handle	17 ¾ in 45 cm



Single-use products are sold sterile.
Kits Include Forceps, 12 ft (3.6 m) Cord and Surgi-Wipe.

Questions? Contact us at customerservice@symmetrysurgical.com
or learn more at symmetrysurgical.com

Ultra™ Monopolar Laparoscopic Forceps

“Hunter Type” Bowel Grasper

Direct Drive, Monopolar Laparoscopy Forceps, 5.0 mm, Insulated

CODE	DESCRIPTION	LENGTH
94-1093L-26	Locking Handle	10 ¼ in 26 cm
94-1093L	Locking Handle	13 in 33 cm
94-1093L-45	Locking Handle	17 ¾ in 45 cm
94-1093-26	Non-Locking Handle	10 ¼ in 26 cm
94-1093	Non-Locking Handle	13 in 33 cm
94-1093-45	Non-Locking Handle	17 ¾ in 45 cm



Metzenbaum Scissors

Direct Drive, Monopolar Laparoscopy Scissors, 5.0 mm, Insulated

CODE	DESCRIPTION	LENGTH
94-2006-26	Non-Locking Handle	10 ¼ in 26 cm
94-2006	Non-Locking Handle	13 in 33 cm
94-2006-45	Non-Locking Handle	17 ¾ in 45 cm



Straight Scissors

Direct Drive, Monopolar Laparoscopy Scissors, 5.0 mm, Insulated

CODE	DESCRIPTION	LENGTH
94-2009-26	Non-Locking Handle	10 ¼ in 26 cm
94-2009	Non-Locking Handle	13 in 33 cm
94-2009-45	Non-Locking Handle	17 ¾ in 45 cm

Hook Scissors

Direct Drive, Monopolar Laparoscopy Scissors, 5.0 mm, Insulated

CODE	DESCRIPTION	LENGTH
94-2020-26	Non-Locking Handle	10 ¼ in 26 cm
94-2020	Non-Locking Handle	13 in 33 cm
94-2020-45	Non-Locking Handle	17 ¾ in 45 cm

Single-use products are sold sterile.
Kits Include Forceps, 12 ft (3.6 m) Cord and Surgi-Wipe.

Ultra™ Monopolar Laparoscopic Forceps

Accu-SPIN™ Bottle Nose Dissecting Forcep

Monopolar Laparoscopy Forceps, 5.0 mm, Insulated

CODE	DESCRIPTION	LENGTH
97-1030RC	Non-Locking Handle	12½ in 32 cm



Accu-SPIN™ Cup Tooth Dissecting Forceps

Monopolar Laparoscopy Forceps, 5.0 mm, Insulated

CODE	DESCRIPTION	LENGTH
97-1035RC	Non-Locking Handle	12½ in 32 cm

Accu-SPIN™ Micro Fenestrated Forceps

Monopolar Laparoscopy Forceps, 5.0 mm, Insulated

CODE	DESCRIPTION	LENGTH
97-1042RC	Non-Locking Handle	12½ in 32 cm



Accu-SPIN™ Maryland Dissecting Forceps

Monopolar Laparoscopy Forceps, 5.0 mm, Insulated

CODE	DESCRIPTION	LENGTH
97-1067RC	Non-Locking Handle	12½ in 32 cm
97-1067RCL	Non-Locking Handle	17¾ in 45 cm

Single-use products are sold sterile.
Kits Include Forceps, 12 ft (3.6 m) Cord and Surgi-Wipe.

Questions? Contact us at customerservice@symmetrysurgical.com
or learn more at symmetrysurgical.com

Ultra™ Monopolar Laparoscopic Forceps

Accu-CUT™ Endo Scissors

Monopolar Laparoscopy Scissors, 5.0 mm, Insulated

CODE	DESCRIPTION	LENGTH
97-2006RC	Non-Locking Handle	12½ in 32 cm
97-2006RCL	Non-Locking Handle	17¾ in 45 cm



Accu-CUT™ Hook Scissors

Monopolar Laparoscopy Scissors, 5.0 mm, Insulated

CODE	DESCRIPTION	LENGTH
97-2020RC	Non-Locking Handle	12½ in 32 cm

Insulated Lap Handle

CODE	DESCRIPTION	LENGTH
90-0030	Take Apart	12½ in 32 cm



Bottle Nose Dissecting Forceps

Replacement Jaw Assembly, 5.0 mm, Insulated

CODE	DESCRIPTION	LENGTH
90-1030B	Take Apart	12½ in 32 cm



Single-use products are sold sterile.
Kits Include Forceps, 12 ft (3.6 m) Cord and Surgi-Wipe.

Ultra™ Monopolar Laparoscopic Forceps

Bottle Nose Dissecting Forceps

Monopolar Laparoscopy Forceps, with Insulated Handle, 5.0 mm

CODE	DESCRIPTION	LENGTH
90-1030I	Take Apart	12½ in 32 cm
90-1030IL	Take Apart	17¾ in 45 cm



Duckbill Grasping Forceps

Replacement Jaw Assembly, 5.0 mm, Insulated

CODE	DESCRIPTION	LENGTH
90-1040I	Take Apart	12½ in 32 cm
90-1040BL	Take Apart	17¾ in 45 cm



Fenestrated Dissecting Forceps

Replacement Jaw Assembly, 5.0 mm, Insulated

CODE	DESCRIPTION	LENGTH
90-1042BL	Take Apart	12½ in 32 cm
90-1042B	Take Apart	17¾ in 45 cm



Fenestrated Dissecting Forceps

Monopolar Laparoscopy Forceps, with Insulated Handle, 5.0 mm

CODE	DESCRIPTION	LENGTH
90-1042I	Take Apart	12½ in 32 cm
90-1042IL	Take Apart	17¾ in 45 cm



Single-use products are sold sterile.
Kits Include Forceps, 12 ft (3.6 m) Cord and Surgi-Wipe.

Questions? Contact us at customerservice@symmetrysurgical.com
or learn more at symmetrysurgical.com

Ultra™ Monopolar Laparoscopic Forceps

Maryland Dissecting Forceps

Replacement Jaw Assembly, 5.0 mm, Insulated

CODE	DESCRIPTION	LENGTH
90-1065B	Take Apart	12½ in 32 cm
90-1065I	Take Apart	12½ in 32 cm



Mixer Right Angle Dissector

Replacement Jaw Assembly, 5.0 mm, Insulated

CODE	DESCRIPTION	LENGTH
90-1066B	Take Apart	12½ in 32 cm
90-1066I	Take Apart	12½ in 32 cm



Maryland Dissector

Replacement Jaw Assembly, 5.0 mm, Insulated

CODE	DESCRIPTION	LENGTH
90-1067B	Take Apart	12½ in 32 cm
90-1067BL	Take Apart	12½ in 32 cm



Maryland Dissecting Forceps

Monopolar Laparoscopy Forceps, with Insulated Handle, 5.0 mm

CODE	DESCRIPTION	LENGTH
90-1067I	Take Apart	12½ in 32 cm
90-1067IL	Take Apart	17¾ in 45 cm



Single-use products are sold sterile.
Kits Include Forceps, 12 ft (3.6 m) Cord and Surgi-Wipe.

Questions? Contact us at customerservice@symmetrysurgical.com
or learn more at symmetrysurgical.com

Ultra™ Monopolar Laparoscopic Forceps

Mixer Right Angle Dissector

Monopolar Laparoscopy Forceps, with Insulated Handle, 10 mm

CODE	DESCRIPTION	LENGTH
90-1068I	Take Apart	12½ in 32 cm



Insulated Outer Sheath

Take Apart, Insulated

CODE	DESCRIPTION	LENGTH
90-1115	5.0 mm, With Flush Port	12½ in 32 cm
90-1115L	5.0 mm, With Flush Port	17¾ in 45 cm
90-1116	5.0 mm, With Flush Port	12½ in 32 cm
90-1116L	5.0 mm, With Flush Port	17¾ in 45 cm
90-1117	10 mm, Without Flush Port	12½ in 32 cm



Bottle Nose Dissecting Forceps

Monopolar Laparoscopy Forceps, 5.0 mm, Insulated

CODE	DESCRIPTION	LENGTH
90-1030	One-Piece	12½ in 32 cm



Bullet Nose Dissecting Forceps

Monopolar Laparoscopy Forceps, 5.0 mm, Insulated

CODE	DESCRIPTION	LENGTH
90-1033	One-Piece	12½ in 32 cm



Single-use products are sold sterile.
Kits Include Forceps, 12 ft (3.6 m) Cord and Surgi-Wipe.

Questions? Contact us at customerservice@symmetrysurgical.com
or learn more at symmetrysurgical.com

Ultra™ Monopolar Laparoscopic Forceps

Cup Tooth Dissecting Forceps

Monopolar Laparoscopy Forceps, 5.0 mm, Insulated

CODE	DESCRIPTION	LENGTH
90-1035	One-Piece	12½ in 32 cm



Duckbill Grasping Forceps

Monopolar Laparoscopy Forceps, 5.0 mm, Insulated

CODE	DESCRIPTION	LENGTH
90-1040	One-Piece	12½ in 32 cm



Micro Fenestrated Dissecting Forceps

Monopolar Laparoscopy Forceps, 5.0 mm, Insulated

CODE	DESCRIPTION	LENGTH
90-1044	One-Piece	12½ in 32 cm



Maryland Dissecting Forceps

One-Piece, Monopolar Laparoscopy Forceps, 5.0 mm, Insulated

CODE	DESCRIPTION	LENGTH
90-1067	5.0 mm	12½ in 32 cm
90-1065	10 mm	12½ in 32 cm

Ultra™ Monopolar Laparoscopic Forceps

Hook Biopsy Forceps

Monopolar Laparoscopy Forceps, 5.0 mm, Insulated

CODE	DESCRIPTION	LENGTH
90-1073	One-Piece	12½ in 32 cm



Biopsy Forceps

Monopolar Laparoscopy Forceps, 5.0 mm, Insulated

CODE	DESCRIPTION	LENGTH
90-1075	One-Piece	12½ in 32 cm



Hook Scissors

Monopolar Laparoscopy Forceps, 5.0 mm, Insulated

CODE	DESCRIPTION	LENGTH
90-2020	One-Piece	12½ in 32 cm



Single-use products are sold sterile.
Kits Include Forceps, 12 ft (3.6 m) Cord and Surgi-Wipe.

Questions? Contact us at customerservice@symmetrysurgical.com
or learn more at symmetrysurgical.com

Olsen® Monopolar Blade Electrodes

Blade Electrodes

Single-Use, Straight

CODE	DESCRIPTION	LENGTH	QTY
97000	Straight Electrode	2¾ in 70 mm	50
97001	Straight Electrode	6 in 152 mm	25
97002	Straight Electrode	8 in 203 mm	25



Blade Electrodes, with Midas Touch® Non-Stick, Straight

Single-Use, Standard Exposure, 10 per Box

CODE	DESCRIPTION	LENGTH
30-0001	Straight Blade Electrode	2¾ in 70 mm
30-0002	Straight Blade Electrode	4 in 102 mm
30-0003	Straight Blade Electrode	5 in 127 mm
30-0004	Straight Blade Electrode	6 in 152 mm

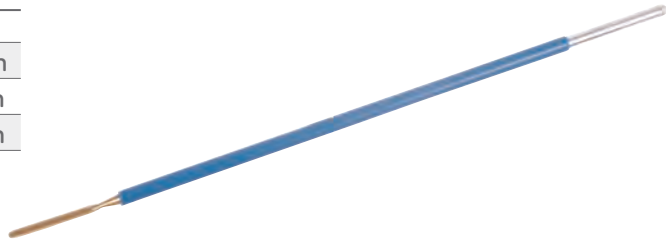

Blade Electrodes, with Midas Touch® Non-Stick, Straight

Single-Use, Modified 2.0 mm Exposure, 10 per Box

CODE	DESCRIPTION	LENGTH
30-1011	Straight Blade Electrode	2¾ in 70 mm
30-1012	Straight Blade Electrode	4 in 102 mm
30-1013	Straight Blade Electrode	5 in 127 mm
30-1014	Straight Blade Electrode	6 in 152 mm

Olsen® Electrode Extenders

Electrode Extenders

Reusable, 1 Each

CODE	DESCRIPTION	LENGTH
67510	Electrode Extender	3 in 76 mm
67511	Electrode Extender	4 in 102 mm
67512	Electrode Extender	5 in 127 mm
67513	Electrode Extender	6 in 152 mm
67516	Electrode Extender	7 in 178 mm
67514	Electrode Extender	8 in 203 mm
67515	Electrode Extender	10 in 254 mm



ENERGY

Ultra™ Laparoscopic Electrodes

Laparoscopic Monopolar Electrodes

Single-Use, 10 per Box

CODE	DESCRIPTION	LENGTH
90-9525-S	J-Hook	13in 33 cm
90-9525-45S	J-Hook	17¾ 45 cm
90-9522-S	L-Hook	13in 33 cm
90-9522-45S	L-Hook	17¾ 45 cm
90-9523-S	Spatula	13in 33 cm
90-9523-45S	Spatula	17¾ 45 cm



Single-use products are sold sterile.
Kits Include Forceps, 12 ft (3.6 m) Cord and Surgi-Wipe.

Questions? Contact us at customerservice@symmetrysurgical.com
or learn more at symmetrysurgical.com

Olsen® Monopolar Loop Electrodes

LLETZ Loop Electrodes, 2.2 in (5.6 cm) Length

Reusable, 1 Each

CODE	LOOP SIZE
69504	15 x 10 mm
69503	20 x 10 mm
69507	20 x 15 mm

LLETZ Loop Electrodes, 5 in (12.7 cm) Length

Reusable, 1 Each

CODE	LOOP SIZE
69100	15 x 8.0 mm
69300	20 x 8.0 mm
69000	10 x 10 mm
69505	10 x 12 mm
69500	15 x 12 mm
69400	20 x 12 mm
69200	15 x 15 mm
69506	20 x 15 mm
69502	20 x 20 mm



LLETZ Square Loop Electrodes, 5 in (12.7 cm) Length

Reusable, 1 Each

CODE	LOOP SIZE
69501	10 x 7.0 mm
69001	10 x 10 mm



Loop Electrodes

Reusable, 1 Each

CODE	LOOP SIZE		LENGTH	
66300	1/8 in	3.2 mm	1 5/8 in	41 mm
66301	1/4 in	6.4 mm	1 3/4 in	44 mm
66302	5/16 in	7.9 mm	1 13/16 in	59 mm
66306	5/16 in	7.9 mm	4 5/16 in	110 mm
66303	3/8 in	9.5 mm	1 7/8 in	48 mm
66307	3/8 in	9.5 mm	4 3/8 in	111 mm
66304	1/2 in	12.7 mm	2.0 in	51 mm
66308	1/2 in	12.7 mm	4 1/2 in	114 mm
66305	3/4 in	19.1 mm	2 1/4 in	57 mm



Single-use products are sold sterile.
Kits Include Forceps, 12 ft (3.6 m) Cord and Surgi-Wipe.

Questions? Contact us at customerservice@symmetrysurgical.com
or learn more at symmetrysurgical.com

Olsen® Monopolar Needle Electrodes

Needle Electrodes, Blunt

Reusable, Straight, Standard 10 mm Exposure, 1 Each

CODE	DESCRIPTION	LENGTH
66114	Blunt Needle-Tip Electrode	2¾ in 70 mm
66115	Blunt Needle-Tip Electrode	4 in 102 mm
66116	Blunt Needle-Tip Electrode	5 in 127 mm
66117	Blunt Needle-Tip Electrode	6 in 152 mm
66118	Blunt Needle-Tip Electrode	7 in 178 mm
66119	Blunt Needle-Tip Electrode	8 in 203 mm



Needle Electrodes, Standard

Reusable, Straight, Standard 10 mm Exposure, 1 Each

CODE	DESCRIPTION	LENGTH
66101	Standard Needle-Tip Electrode	2¾ in 70 mm
66102	Standard Needle-Tip Electrode	4 in 102 mm
66103	Standard Needle-Tip Electrode	5 in 127 mm
66104	Standard Needle-Tip Electrode	6 in 152 mm
66105	Standard Needle-Tip Electrode	7 in 178 mm
66106	Standard Needle-Tip Electrode	8 in 203 mm



Needle Electrodes, Sharp

Reusable, Straight, 1 Each

CODE	DESCRIPTION	LENGTH
66107	Sharp Needle-Tip Electrode	2¾ in 70 mm
66108	Sharp Needle-Tip Electrode	4 in 10.2 cm
66109	Sharp Needle-Tip Electrode	5 in 127 mm
66110	Sharp Needle-Tip Electrode	6 in 152 mm
66111	Sharp Needle-Tip Electrode	7 in 178 mm
66112	Sharp Needle-Tip Electrode	8 in 203 mm

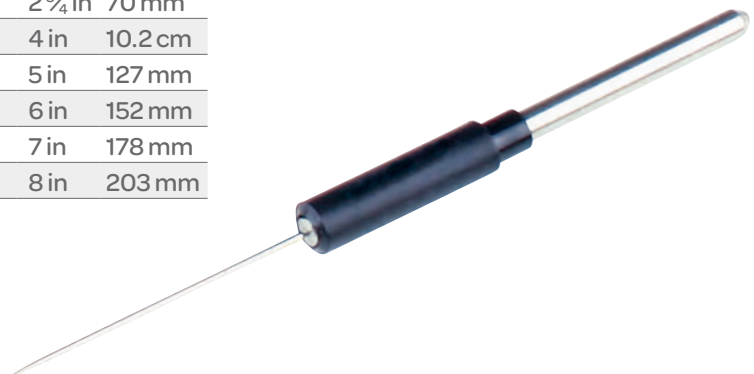

Single-use products are sold sterile.
Kits Include Forceps, 12 ft (3.6 m) Cord and Surgi-Wipe.

Questions? Contact us at customerservice@symmetrysurgical.com
or learn more at symmetrysurgical.com

Olsen® Monopolar Needle Electrodes

Needle Electrode, Short/Close-Up

Reusable, Straight, Standard 10 mm Exposure, 1 Each

CODE	DESCRIPTION	LENGTH
66800	Needle-Tip Electrode	2 in 51 mm



Needle Electrodes, Blunt

Reusable, Straight, Modified 2.0 mm Exposure, 1 Each

CODE	DESCRIPTION	LENGTH
67003	Blunt Needle-Tip Electrode	2¾ in 70 mm
67004	Blunt Needle-Tip Electrode	6 in 152 mm



Needle Electrodes, Standard

Reusable, Straight, Modified 2.0 mm Exposure, 1 Each

CODE	DESCRIPTION	LENGTH
67000	Standard Needle-Tip Electrode	2¾ in 70 mm
67001	Standard Needle-Tip Electrode	4 in 102 mm
67002	Standard Needle-Tip Electrode	6 in 152 mm
67008	Standard Needle-Tip Electrode	8¾ in 222 mm



Needle Electrodes, Standard

Reusable, Straight, Modified 2.0 mm Exposure, 1 Each

CODE	DESCRIPTION	LENGTH
67008	Standard Needle-Tip Electrode, Bayonet	8¾ in 222 mm

Olsen® Monopolar Needle Electrodes

Needle Electrodes

Single-Use, Straight

CODE	DESCRIPTION	LENGTH	QTY
97100	Needle Electrode	2¾ in 70 mm	50
97101	Needle Electrode	6 in 152 mm	10



Needle Electrodes, Straight

Single-Use, Tungsten Wire Micro Dissection, 1 Each

CODE	DESCRIPTION	LENGTH
97110	Standard Sharp Needle Electrode	1½ in 38 mm
97111	Standard Sharp Needle Electrode	2 in 51 mm
97112	Standard Sharp Needle Electrode	2⅜ in 60 mm
97116	Standard Sharp Needle Electrode	3½ in 89 mm
97117	Standard Sharp Needle Electrode	4½ in 114 mm
97114	Standard Sharp Needle Electrode	6 in 152 mm



Needle Electrodes, 45° Angled Shaft

Single-Use, Tungsten Wire Micro Dissection, 10 mm from Tips, 1 Each

CODE	DESCRIPTION	LENGTH
97115	Standard Sharp Needle Electrode	2⅜ in 60 mm

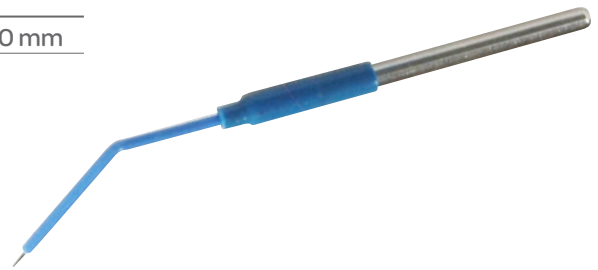

Needle Electrode, Bayonet Shaft

Single-Use, Tungsten Wire Micro Dissection, 1 Each

CODE	DESCRIPTION	LENGTH
97125	Ultra Sharp Needle Electrode	6 in 152 mm

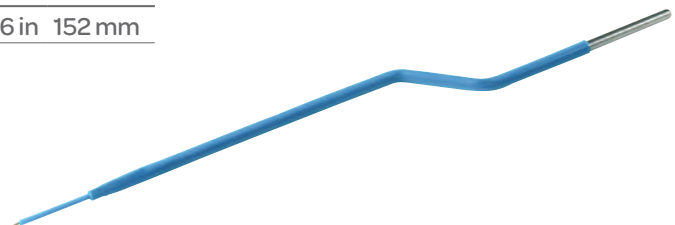

Single-use products are sold sterile.
Kits Include Forceps, 12 ft (3.6 m) Cord and Surgi-Wipe.

Questions? Contact us at customerservice@symmetrysurgical.com
or learn more at symmetrysurgical.com

Olsen® Monopolar Needle Electrodes

Needle Electrodes, Straight

Single-Use, Ultra Sharp, Tungsten Wire Micro Dissection, 1 Each

CODE	DESCRIPTION	LENGTH
97130	Ultra Sharp Needle Electrode	1¼ in 32 mm
97131	Ultra Sharp Needle Electrode	1⅝ in 41 mm
97132	Ultra Sharp Needle Electrode	2 in 51 mm
97133	Ultra Sharp Needle Electrode	2½ in 64 mm
97134	Ultra Sharp Needle Electrode	4⅝ in 118 mm
97135	Ultra Sharp Needle Electrode	5½ in 140 mm
97136	Ultra Sharp Needle Electrode	6⅝ in 168 mm

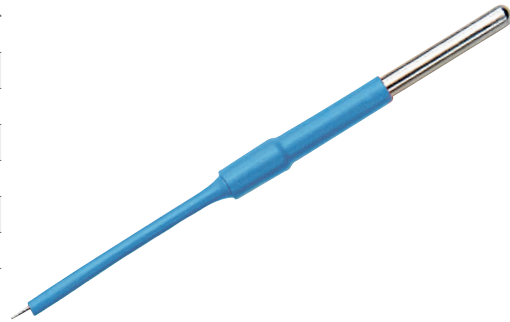

Needle Electrodes, Angled Tip, 3.0 mm

Single-Use, Ultra Sharp, Tungsten Wire Micro Dissection, 1 Each

CODE	DESCRIPTION	LENGTH
97141	Ultra Sharp Needle Electrode	1⅝ in 41 mm
97143	Ultra Sharp Needle Electrode	2 in 51 mm
97144	Ultra Sharp Needle Electrode	4 in 102 mm
97145	Ultra Sharp Needle Electrode	4⅝ in 118 mm
97147	Ultra Sharp Needle Electrode	6⅝ in 168 mm
97148	Ultra Sharp Needle Electrode	7 in 178 mm

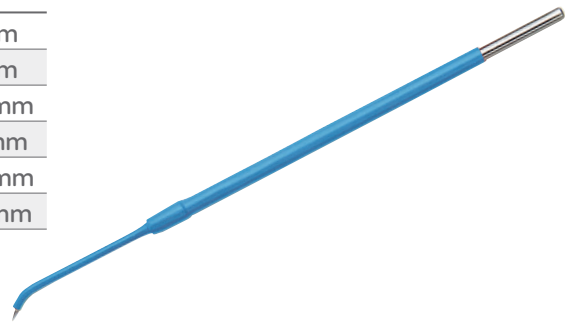

Needle Electrodes, Angled Shaft, 10 mm

Single-Use, Ultra Sharp, Tungsten Wire Micro Dissection, 1 Each

CODE	DESCRIPTION	LENGTH
97150	Ultra Sharp Needle Electrode	2 in 51 mm
97152	Ultra Sharp Needle Electrode	4⅞ in 124 mm
97154	Ultra Sharp Needle Electrode	6⅞ in 175 mm

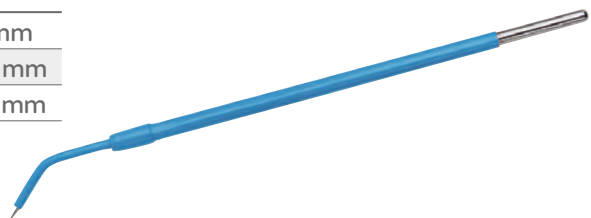

Needle Electrodes, Curved Shaft

Single-Use, Ultra Sharp, Tungsten Wire Micro Dissection, 1 Each

CODE	DESCRIPTION	LENGTH
97170	Ultra Sharp Needle Electrode	4 in 102 mm
97171	Ultra Sharp Needle Electrode	5⅞ in 149 mm

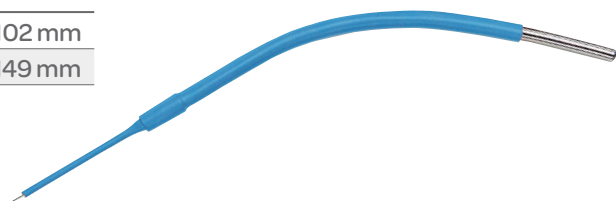

Single-use products are sold sterile.
Kits Include Forceps, 12 ft (3.6 m) Cord and Surgi-Wipe.

Olsen® Monopolar Needle Electrodes

Needle Electrodes, with Midas Touch® Non-Stick

Single-Use, Standard Exposure, Straight, 10 per Box

CODE	DESCRIPTION	LENGTH
30-1001	Needle Electrode	2¾ in 70 mm
30-1002	Needle Electrode	4 in 102 mm
30-1003	Needle Electrode	5 in 127 mm
30-1004	Needle Electrode	6 in 152 mm

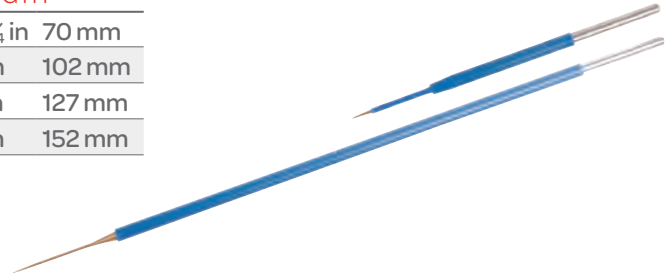

Needle Electrode, with Midas Touch® Non-Stick

Single-Use, Modified 2.0 mm Exposure, Bayonet, 10 per Box

CODE	DESCRIPTION	LENGTH
30-1015	Needle Electrode	5¾ in 146 mm

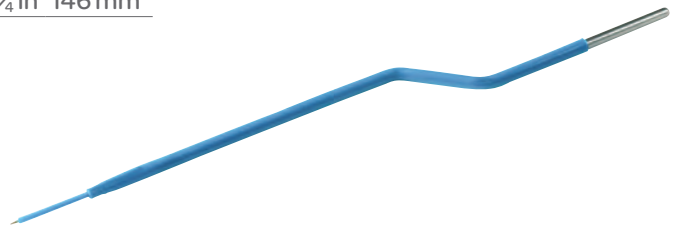

Olsen® Suction Coagulators

Suction Coagulators

Single-Use, 6 in (152 mm), 10 French, 10 per Box

CODE	DESCRIPTION
20-8020	Foot-Controlled, Requires 960xx Series Adapter
20-8040	Hand-Controlled



Single-use products are sold sterile.
Kits Include Forceps, 12 ft (3.6 m) Cord and Surgi-Wipe.

Questions? Contact us at customerservice@symmetrysurgical.com
or learn more at symmetrysurgical.com

Olsen® Electrosurgical Cords

Bipolar Cords

Reusable, 1 Each

CODE	DESCRIPTION	PLUG	LENGTH
87006	Shrouded Instrument Connector	Fixed-Pin Generator	12 ft 3.6 m
87110	European Flat Instrument Connector	Fixed-Pin Generator	12 ft 3.6 m
50-1106	45° Angled Instrument Connector	Fixed-Pin Generator	12 ft 3.6 m
87600	Instrument Connector	Wolf-Style Generator	12 ft 3.6 m



Bipolar Cords

Single-Use, 1 Each

CODE	DESCRIPTION	PLUG	LENGTH
40-1105	Straight Instrument Connector	Fixed-Pin Generator	12 ft 3.6 m
40-1106	45° Angled Instrument Connector	Fixed-Pin Generator	12 ft 3.6 m
40-1107	Straight Instrument Connector	Fixed-Pin Generator	12 ft 3.6 m
40-1114	Instrument Connector	Wolf-Style Generator	12 ft 3.6 m
40-1115	Wolf-Style Instrument Connector	Valleylab-Style Generator	12 ft 3.6 m



Integrated Irrigation Tubing and Bipolar Cord Set for Rotary Pumps

Integrated Irrigation Tubing and Bipolar Cord Set for Rotary Pumps, 10 per Box

CODE	DESCRIPTION	PLUG	LENGTH
40-3003R	On/Off Clamp	Fixed-Pin Generator	12 ft 3.6 m

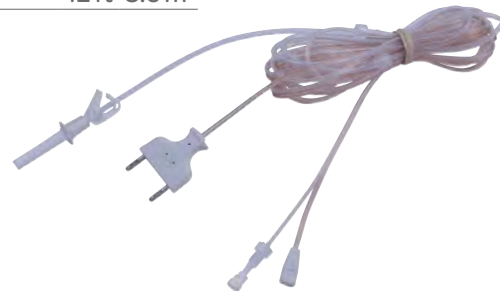

Monopolar Cords

Reusable, 1 Each

CODE	DESCRIPTION	PLUG	LENGTH
20002	2.0 mm European-Style Recessed Pin Female	5/32 in (4.0 mm) Male Generator	10 ft 3.0 m
20003	TUR/Resectoscope Female	Valleylab-Style Male Generator	10 ft 3.0 m
20006	2.0 mm European-Style Recessed Pin Female	Valleylab-Style Male Generator	10 ft 3.0 m

Single-use products are sold sterile.
Kits Include Forceps, 12 ft (3.6 m) Cord and Surgi-Wipe.

Olsen® Electrosurgical Cords



Monopolar Cords

Reusable, 1 Each

CODE	DESCRIPTION	PLUG	LENGTH
90018	Olsen® Threaded Instrument Connector	$\frac{5}{32}$ in (4.0 mm) Male Generator	10 ft 3.0 m
90020	Olsen® Threaded Instrument Connector	Valleylab-Style Male Generator	10 ft 3.0 m
90054	Laparoscopic Instrument Connector	$\frac{5}{32}$ in (4.0 mm) Male Generator	10 ft 3.0 m
90056	Laparoscopic Instrument Connector	Valleylab-Style Male Generator	10 ft 3.0 m
90065	3.0 mm Olympus-Style Snare Connector	$\frac{5}{32}$ in (4.0 mm) Male Generator	10 ft 3.0 m
90067	3.0 mm Olympus-Style Snare Connector	Valleylab-Style Male Generator	10 ft 3.0 m
50-2107	Endoscopic Instrument Connector, Straight	Valleylab-Style Male Generator	10 ft 3.0 m
50-2111	Endoscopic Instrument Connector, Angled 90°	Valleylab-Style Male Generator	10 ft 3.0 m



Monopolar Cords

Single-Use, 10 per Box

CODE	DESCRIPTION	PLUG	LENGTH
40-2110	Endoscopic Instrument Connector, Straight	Valleylab-Style Generator	10 ft 3.0 m
40-2106	Endoscopic Instrument Connector, Angled 90°	Valleylab-Style Generator	10 ft 3.0 m



Monopolar Cords

Single-Use, 50 per Box

CODE	DESCRIPTION	PLUG	LENGTH
92002	Resectoscope Instrument Connector, Angled 90°	Crimped Wire Generator	10 ft 3.0 m

Single-use products are sold sterile.
Kits Include Forceps, 12 ft (3.6 m) Cord and Surgi-Wipe.

Questions? Contact us at customerservice@symmetrysurgical.com
or learn more at symmetrysurgical.com

Olsen® Exposed Top Forceps

Adson Forceps

Reusable, Serrated Tips, Straight, 1 Each



CODE	DESCRIPTION	TIP SIZE	LENGTH
42509	Insulated, Exposed Top	1.0 mm	5 in 127 mm

Bayonet Forceps

Reusable, Insulated, Smooth Tips, 1 Each



CODE	DESCRIPTION	TIP SIZE	LENGTH
41207	Insulated, Exposed Top	1.0 mm	7¾ in 197 mm
41206	Insulated, Exposed Top	1.5 mm	7¾ in 197 mm
41406	Insulated, Exposed Top	1.0 mm	8 in 203 mm
41405	Insulated, Exposed Top	2.0 mm	8 in 203 mm
41607	Insulated, Exposed Top	2.0 mm	8½ in 216 mm

DeBakey Forceps

Reusable, 1 Each



CODE	DESCRIPTION	TIP SIZE	LENGTH
44012	Insulated, Exposed Top	1.0 mm	6 in 127 mm
44006	Insulated, Exposed Top	1.5 mm	7¾ in 197 mm
44004	Insulated, Exposed Top	1.5 mm	9½ in 241 mm

Potts-Smith Forceps

Reusable, Exposed Top, Serrated Tips, 1 Each



Length (L)	7½ in 191 mm	8½ in 216 mm	9¾ in 248 mm	10 in 254 mm	12 in 305 mm
TIP SIZE	INSULATED	INSULATED	INSULATED	INSULATED	INSULATED
0.5 mm	42211		42411		
1.0 mm	42209	42309	42410		44005
1.5 mm	42208	42308	42409	44013	44000
2.0 mm	42207	42307	42408		

Single-use products are sold sterile.
Kits Include Forceps, 12 ft (3.6 m) Cord and Surgi-Wipe.

Olsen® Monopolar Adapters

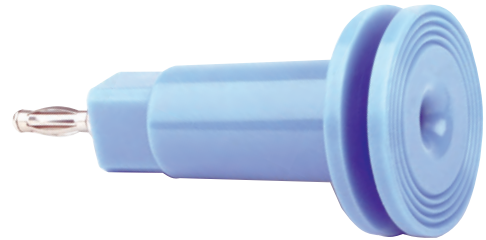

Monopolar Generator Adapter

Electrosurgical Accessory, 1 Each

CODE	DESCRIPTION	PLUG
96000	Crimped Wire $\frac{1}{8}$ in (3.2 mm) Cord Female	$\frac{5}{32}$ in (4.0 mm) Male Generator Plug
96001	Crimped Wire $\frac{1}{8}$ in (3.2 mm) Cord Female	Valleylab-Style Male Generator Plug
96002	European/Wolf-Style Female	Valleylab-Style Male Generator Plug

History of Symmetry Surgical's Energy Portfolio

In 1973, Olsen® Medical introduced the first line of single-use monopolar electrosurgical handles for use as electrosurgical pens and pencils.

Now part of Symmetry Surgical, Olsen®'s innovative energy portfolio has expanded to include our Extendable Electrosurgical Pencil as well as a wide array of electrodes and monopolar forceps, cords and adapters to satisfy your needs.



Symmetry Surgical's Olsen® Bipolar Forceps

In 1988, Olsen® Medical introduced the first line of cost-effective, single-use bipolar forceps, and ten years later we introduced our innovative Midas Touch® non-stick bipolar forceps.

Today, as part of Symmetry Surgical, Olsen® continues to focus on innovative and cost-effective ways to improve patient outcomes.



Single-use products are sold sterile.
Kits Include Forceps, 12 ft (3.6 m) Cord and Surgi-Wipe.

Questions? Contact us at customerservice@symmetrysurgical.com or learn more at symmetrysurgical.com

Olsen® Monopolar Pencils

Electrosurgical Pencils

Reusable, Blade Electrode, Foot-Activated, 1 Each



CODE	DESCRIPTION	PLUG
65000	Attached 10 ft (3.0m) Cord	Valleylab-Style Generator
65006	Attached 10 ft (3.0m) Cord	European/Wolf-Style Generator

Electrosurgical Pencil

Reusable, Blade Electrode, Hand-Activated, Button Switch, 1 Each



CODE	DESCRIPTION	PLUG
75000	Attached 10 ft (3.0m) Cord	3-Prong Generator

Electrosurgical Pencils

Single-Use, Blade Electrode, Hand-Activated, Button Switch, 50 per Box

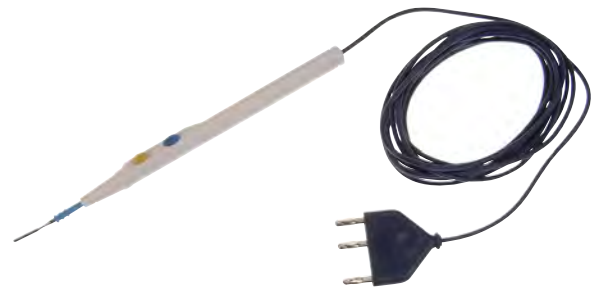

CODE	DESCRIPTION	PLUG
75530	Attached 10 ft (3.0 m) Cord	3-Prong Generator
75540	Attached 10 ft (3.0 m) Cord, Holster, Tip Cleaner	3-Prong Generator
75541	Attached 10 ft (3.0 m) Cord, Holster	3-Prong Generator

Single-use products are sold sterile.
Kits Include Forceps, 12 ft (3.6 m) Cord and Surgi-Wipe.

Olsen® Monopolar Pencils



Electrosurgical Pencils

Single-Use, Blade Electrode, Hand-Activated, Rocker Switch, 50 per Box

CODE	DESCRIPTION	PLUG
75610	Attached 10 ft (3.0 m) Cord	3-Prong Generator
75620	Attached 10 ft (3.0 m) Cord, Holster, Tip Cleaner	3-Prong Generator
75621	Attached 10 ft (3.0 m) Cord, Holster	3-Prong Generator

Electrosurgical Pencils

Single-Use, Blade Electrode, Foot-Activated

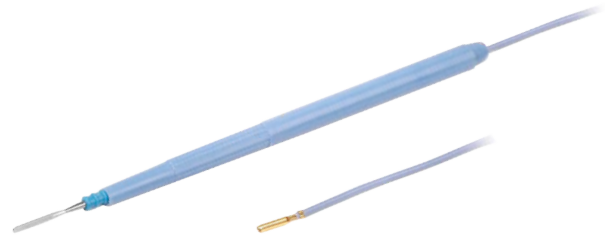

CODE	DESCRIPTION	PLUG	QTY
95012	Attached 10 ft (3.0 m) Cord	Crimped Wire Connector (uses 960 Series Adapter)	100/Box
95017	Attached 10 ft (3.0 m) Cord, Packaged with Holster and Tip Cleaner	Crimped Wire Connector (uses 960 Series Adapter)	50/Box



Extendable Electrosurgical Pencils, with Midas Touch® Non-Stick

Single-Use, Midas Touch Non-Stick Blade Electrode, Hand-Activated, Button Switch, 25 per Box

CODE	DESCRIPTION	ADJUSTMENT
75800	Attached 10 ft (3.0 m) Cord with 3-Prong Generator Plug, Standard Blade	Easily Adjusts from 2 ½ to 5 ½ in
75802	Attached 10 ft (3.0 m) Cord with 3-Prong Generator Plug, Holster, Standard Blade	Easily Adjusts from 2 ½ to 5 ½ in
75810	Attached 10 ft (3.0 m) Cord with 3-Prong Generator Plug, Modified Blade	Easily Adjusts from 2 ½ to 5 ½ in
75820	Attached 10 ft (3.0 m) Cord with 3-Prong Generator Plug, Modified Needle	Easily Adjusts from 2 ½ to 5 ½ in

Single-use products are sold sterile.

Kits Include Forceps, 12 ft (3.6 m) Cord and Surgi-Wipe.

Questions? Contact us at customerservice@symmetrysurgical.com or learn more at symmetrysurgical.com

Olsen® Energy Accessories

Anesthesia Circuit Shield

Laser Safety Product, 6 per Box

CODE	DESCRIPTION	SIZE
60-7100	Laser Safety Product	12 x 48 in 305 mm x 1.2 m

Holsters

Single-Use, Sterile, 50 per Box

CODE	DESCRIPTION
77000	Holster Packaged with Tip Cleaner
77001	Holster Only
77005	Holster with Self-Retaining Metal Clip
77006	Holster with Self-Retaining Metal Clip, Packaged with Tip Cleaner



77005

Graves Vaginal Speculums, with Smoke Tube

CODE	DESCRIPTION	SIZE
50001	Insulated, with Smoke Tube	3 x ¾ in 76 x 20 mm
50101	Insulated, with Smoke Tube	4 x 1 ⅜ in 102 x 35 mm
50201	Insulated, with Smoke Tube	4 ½ x 1 ½ in 114 x 35 mm
50002	Non-Insulated, Non-Reflective	3 x ¾ in 76 x 20 mm
50102	Non-Insulated, Non-Reflective	4 x 1 ⅜ in 102 x 35 mm
50202	Non-Insulated, Non-Reflective	4 ½ x 1 ½ in 114 x 35 mm



Open-Sided Vaginal Speculum

CODE	DESCRIPTION	SIZE
50301	Insulated, with Smoke Tube	4 ½ x 1 ⅜ in 114 x 35 mm



Single-use products are sold sterile.
Kits Include Forceps, 12 ft (3.6 m) Cord and Surgi-Wipe.

Questions? Contact us at customerservice@symmetrysurgical.com
or learn more at symmetrysurgical.com

Olsen® Energy Accessories

Binocular Eye Shield

Single-Use, Laser Safety Product

CODE	DESCRIPTION	QTY
60-7000-OL	Eye Shield	12/Box



Personnel Shield

Single-Use, Drapes Between Sterile Field & Anesthesiologist, 6 per Box

CODE	DESCRIPTION	SIZE
60-7200	Sterile Safety Drape	30 x 60 in 762 mm x 1.5 m

ProClean™ Tip Cleaning Pads with Adhesive Back

Single-Use, Sterile

CODE	DESCRIPTION	QTY
97500	Electrosurgical Accessory	50/Box
97501	Electrosurgical Accessory	144/Box



Replacement Stylets for Irrigating Bipolar Forceps

CODE	DESCRIPTION	LENGTH	QTY
08-1130	For Irrigating Bipolar Forceps		12/Box
60-0300	For Irrigating Bipolar Forceps	10 ¼ in 260 mm	5/Box

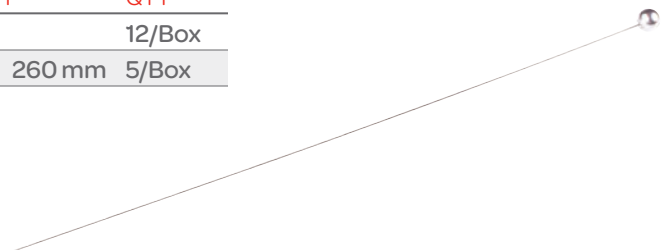

Single-use products are sold sterile.
Kits Include Forceps, 12 ft (3.6 m) Cord and Surgi-Wipe.

Questions? Contact us at customerservice@symmetrysurgical.com
or learn more at symmetrysurgical.com



Scan the code above
to learn more about our
Ear, Nose & Throat portfolio.

Ear, Nose & Throat Portfolio



symmetry surgical™

Ear, Nose & Throat



Adenotomes	ENT-2	Foot Plate Hooks	ENT-43	Presses	ENT-93
Arch Bars	ENT-3	Forceps	ENT-44	Probes	ENT-94
Awls	ENT-3	Handles	ENT-64	Punches	ENT-95
Brushes	ENT-3	Hooks	ENT-64	Rasps	ENT-100
Calipers	ENT-4	Inserters	ENT-71	Retractors	ENT-106
Cannulas	ENT-4	Instrument Covers	ENT-71	Rongeurs	ENT-118
Chisels	ENT-5	Knives	ENT-72	Saws	ENT-123
Clamps	ENT-7	Laryngoscope	ENT-79	Scissors	ENT-123
Connectors	ENT-7	Loops	ENT-79	Snares	ENT-138
Containers	ENT-8	Mallets	ENT-79	Speculums	ENT-139
Crushers	ENT-8	Mirrors	ENT-80	Spreaders	ENT-145
Curettes	ENT-9	Mobilizers	ENT-80	Suction Tubes	ENT-145
Cutting Blocks	ENT-18	Mouth Gags	ENT-81	Syringes	ENT-148
Dilators	ENT-18	Needles	ENT-83	Tracheal Tubes	ENT-148
Dissectors	ENT-19	Nippers	ENT-85	Trocars	ENT-148
Elevators	ENT-20	Sponges	ENT-86	Tuning Forks	ENT-149
Energy	ENT-30	Osteotomes	ENT-86	Wire Guides	ENT-149
Excavators	ENT-43	Picks	ENT-89		

Questions? Contact us at customerservice@symmetrysurgical.com or learn more at symmetrysurgical.com



The Surgical Instrument Desk Reference

How to Use Our Catalog

The Symmetry Surgical catalog is designed with you in mind, to be your trusted resource for surgical instrumentation. We took great care in creating an easy-to-use, robust catalog and we think you'll be pleased with the design as you become more familiar with our broad portfolio.

Layout

The catalog is organized by surgical specialty *and* product function.

And we know that it is difficult to pick up an instrument and know what specialty it's listed in. To make your job easier, we've sorted the instruments in our portfolio by surgical function, too, including Energy, Laparoscopic, Retractors and Sterilization Solutions.

U.S. Customer Service

Your Symmetry Surgical Customer Service team wants to make ordering surgical instruments the easiest part of your day. We accept orders via phone, fax, email, our website, Global Healthcare Exchange (GHX) and through the mail.

PHONE

800.251.3000

(Available Monday through Friday, 8:30 AM–6:30 PM EST)

FAX

800.342.3272

EMAIL

customerservice@symmetrysurgical.com

ONLINE

symmetrysurgical.com

MAILING ADDRESS

Symmetry Surgical
Attn: Customer Service
3034 Owen Drive
Antioch, TN 37013

The Surgical Instrument Desk Reference

International Customer Service

PHONE

Symmetry Surgical Switzerland GmbH
+41 (0) 52 557 59 00
(Available Monday through Friday, 7:00-16:00 GMT)

Symmetry Surgical, Inc., USA
615.964.5672
(Available Monday through Friday, 8:30 AM-6:30 PM EST)

FAX

Symmetry Surgical Switzerland GmbH
+41 (0) 52 557 59 99

EMAIL

customerservice@symmetrysurgical.com
internationalorders@symmetrysurgical.com

ONLINE

symmetrysurgical.com

MAILING ADDRESS

Symmetry Surgical Switzerland GmbH
Bühlstrasse 27
CH-8200 Schaffhausen
Switzerland

Symmetry Surgical, Inc.
3034 Owen Drive
Antioch, TN 37013

INTERNATIONAL PAYMENT TERMS/RETURN GOODS POLICY/INSTRUMENT REPAIR & RESTORE PROGRAM/LITERATURE REQUESTS

Please contact your local distributor. Locate a local distributor contact, International Customer Service at +41 (0) 52 557 59 00 or 615.964.5672 (US).

Cardiovascular/Thoracic

Energy

Ear, Nose & Throat

General

Laparoscopic

Neurology

Obesity

OB/GYN

Ophthalmology

Orthopedics & Arthroscopy

Pediatrics

Rectal

Retractors

Spine

Urology

Sterilization Solutions

Alphabetical & Numeric Indexes

EAR, NOSE & THROAT

Adenotomes (Tonsil & Laryngeal)



71-1010

Laforce Adenotome

CODE	DESCRIPTION	WIDTH
71-1000	Infant	8.0 mm
71-1010	#0 Child	11 mm
71-1011	#1 Small	12 mm
71-1012	#2 Medium	16 mm
71-1013	#3 Large	18 mm

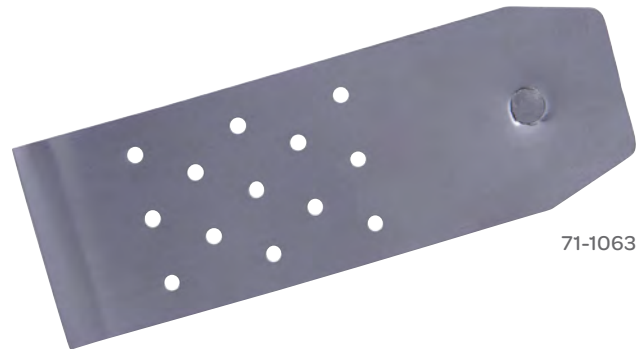

71-1063

Adenotome Blades

CODE	DESCRIPTION	WIDTH
71-1050	Blade, Infant	8.0 mm
71-1060	Blade #0, Child	11 mm
71-1061	Blade #1, Small	12 mm
71-1062	Blade #2, Medium	16 mm
71-1063	Blade #3 Large	18 mm

Arch Bars

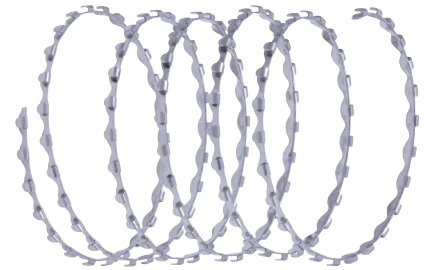

68-1505

Erich Arch Bar

CODE	DESCRIPTION
68-1505	1 Meter Roll
68-1510	Pack of 12, 5½ in (140 mm) Long

Awls (Sinus & Nasal)



Obwegeser Zygomatic Arch Awl

CODE	DESCRIPTION	LENGTH
68-0410	Curved	9½ in 241 mm

Brushes (Laryngoscope Cleaning)



74-6973

Laryngoscope Cleaning Brush

CODE	LENGTH
74-6971	10 in 270 mm
74-6972	11 in 280 mm
74-6973	11 in 280 mm

Calipers (Middle Ear)



Austin Strut Calipers

CODE	DESCRIPTION	LENGTH
61-0310	Markers at 3.5 mm, 4.0 mm and 4.5 mm From Tip	6 in 150 mm

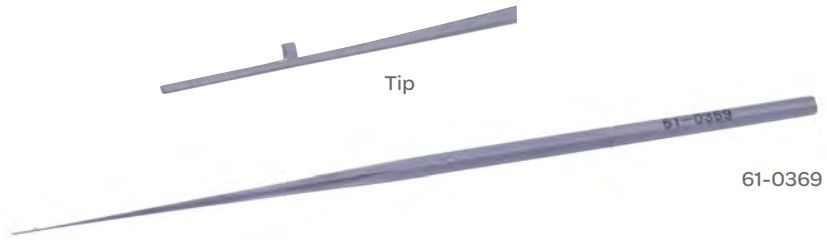

House Strut Calipers

CODE	DESCRIPTION	LENGTH
61-0367	Marker 3.5 mm From Tip	6 ½ in 165 mm
61-0368	Marker 4.0 mm From Tip	6 ½ in 165 mm
61-0369	Marker 4.5 mm From Tip	6 ½ in 165 mm

Cannulas (Sinus & Nasal, Sinus, Sinus Suction Cannula)

Killian Antrum Cannula

CODE	DESCRIPTION	LENGTH
66-6022	3.5 mm Tip	6 in 150 mm



Cannulas (Sinus & Nasal, Sinus, Sinus Suction Cannula)

Van Alyea Sinus Cannula

CODE	DESCRIPTION	LENGTH
66-6042	2.0 mm, Slight Curve	6 in 150 mm



Sinus Suction Cannula

CODE	DESCRIPTION	LENGTH
63-7567	2.5 mm Short Curve	5 3/4 in 145 mm
63-7562	3.0 mm Short Curve	5 3/4 in 145 mm
63-7564	4.0 mm Short Curve	5 3/4 in 145 mm
63-7566	2.5 mm Long Curve	5 3/4 in 145 mm
63-7560	3.0 mm Long Curve	5 3/4 in 145 mm
63-7565	4.0 mm Long Curve	5 3/4 in 145 mm



Cannulas (Trocar and Cannula)

Sinuscopy Trocar and Cannula

CODE	TIP SIZE	LENGTH
09-5228	3.5 mm	6 3/4 in 170 mm
09-5229	5.0 mm	6 3/4 in 170 mm

Chisels (Middle Ear, Sinus & Nasal)

Austin Chisel

CODE	DESCRIPTION	TIP WIDTH	LENGTH
61-0311	Straight	1.0 mm	6 1/4 in 160 mm

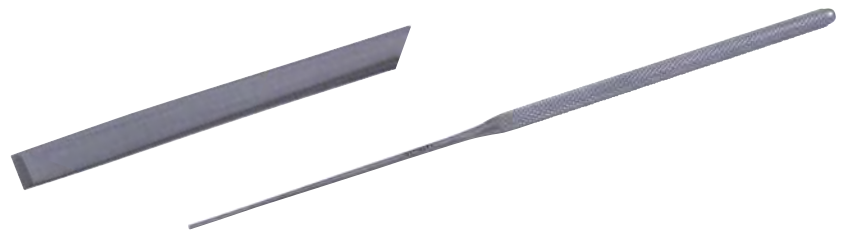

Chisels (Middle Ear, Sinus & Nasal)

Ballenger Chisel

V-Shaped Edge



63-0091

CODE	DESCRIPTION	LENGTH
63-0088	2 mm Wide	6¼ in 160 mm
63-0089	4 mm Wide	6¼ in 160 mm
63-0090	6 mm Wide	6¼ in 160 mm
63-0091	8 mm Wide	6¼ in 160 mm

Cottle Chisel

with Centimeter Markings at 40 mm, 60 mm and 70 mm

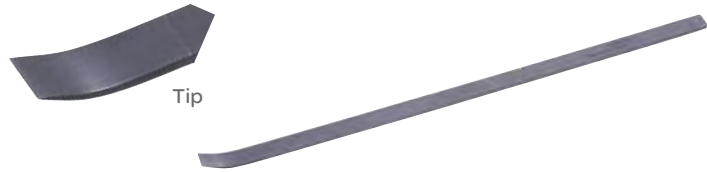

CODE	DESCRIPTION	LENGTH
63-0110	Curved	7¼ in 185 mm

Chisel

CODE	DESCRIPTION	LENGTH
68-0404	Single Bevel, 4 mm Tip, Round Handle	6¾ in 170 mm



Freer Chisel

CODE	DESCRIPTION	LENGTH
63-0084	Straight, 5 mm Wide	6¾ in 170 mm
63-0085	Curved, 5 mm Wide	6¾ in 170 mm



63-0084

Clamps (Sinus & Nasal, Middle Ear)



Cottle Columella Clamp

CODE	DESCRIPTION	JAW WIDTH	LENGTH
67-5860	With Adjusting Screw	14 mm	4 3/8 in 110 mm



Tip



Derlacki Ossicle Holding Clamp

CODE	DESCRIPTION	VERTICAL GROOVE	HORIZONTAL GROOVE	LENGTH
61-0511	1.0 mm Teeth	1.5 x 4 mm	1.5 x 2 mm	4 3/4 in 120 mm



Tip



Sheehy Ossicle Holding Clamp

CODE	DESCRIPTION	VERTICAL GROOVE	LENGTH
61-0512	5 mm Teeth	1.5 x 4 mm	4 3/4 in 120 mm

Connectors (Middle Ear)



House Cut-Off Adapter

CODE	DESCRIPTION	LENGTH
61-1045	for Use with Rosen Suction	2 in 50 mm

Containers (Tray, Middle Ear)

Metapak Tray

Stainless Steel

CODE	DESCRIPTION	HEIGHT
7322-03-200S	Half Length Tray	2 in 50 mm
7310-03-200A	Full Length Tray	2 in 50 mm

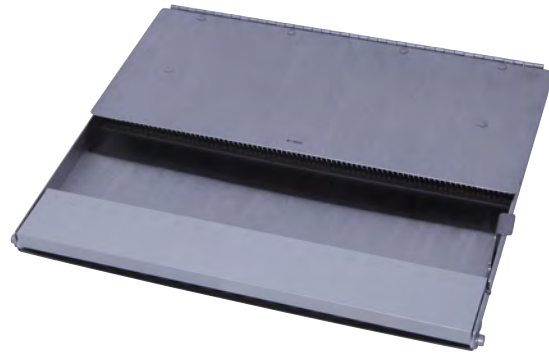

Paparella Instrument Rack

61-3835

CODE	DESCRIPTION
61-3835	Holds up to 20 Instruments, for Tympanoplasty and Stapes Instruments

Crushers (Cartilage)



67-1970

Cottle Cartilage Crusher

CODE	DESCRIPTION
67-1970	Cartilage Crusher

Curettes (Adenoid)



71-3610

Barnhill Adenoid Curette

CODE	SIZE	BLADE	LENGTH	
71-3610	0	10 mm	8 ¾ in	220 mm
71-3612	1	12 mm	8 ¾ in	220 mm
71-3614	2	14 mm	8 ¾ in	220 mm
71-3616	3	16 mm	8 ¾ in	220 mm
71-3618	4	18 mm	8 ¾ in	220 mm
71-3810	0	10 mm, Reverse Curve	8 ½ in	215 mm
71-3812	1	12 mm, Reverse Curve	8 ½ in	215 mm
71-3814	2	14 mm, Reverse Curve	8 ½ in	215 mm
71-3816	3	16 mm, Reverse Curve	8 ½ in	215 mm
71-3818	4	18 mm, Reverse Curve	8 ½ in	215 mm

Curettes (Adenoid)

Jones Adenoid Curette

CODE	DESCRIPTION	BLADE SIZE	LENGTH	
71-3800	Infant Size	4 mm	8 ¾ in	220 mm
71-3801	Child	6 mm	8 ¾ in	220 mm
71-3802	Adult	8 mm	8 ¾ in	220 mm

Middleton Adenoid Curette

CODE	DESCRIPTION	BLADE SIZE	LENGTH	
71-3209	Infant Size	8 mm	8 ¾ in	220 mm

Curettes (Adenoid)



Stubbs Adenoid Curette

CODE	DESCRIPTION	BLADE	LENGTH
71-4111	Infant Size	4 mm	8 ¾ in 220 mm
71-4113	Child	6 mm	8 ¾ in 220 mm
71-4115	Adult	8 mm	8 ¾ in 220 mm

Vogel Adenoid Curette

CODE	DESCRIPTION	BLADE	LENGTH
71-3208	Infant Size	7 mm Wide	8 ½ in 215 mm

Curettes (Bone)



Lempert Bone Curette

Oval, Straight, Delicate

CODE	TIP	LENGTH
29-6706	#6/0	8 in 200 mm
29-6715	#5/0	8 in 200 mm
29-6724	#4/0	8 in 200 mm
29-6733	#3/0	8 in 200 mm
29-6742	#2/0	8 in 200 mm
29-6750	#0	8 in 200 mm
29-6751	#1	8 in 200 mm
29-6752	#2	8 in 200 mm

Curettes (Double-Ended, Ear)

Lucas Curette



CODE	SIZE	LENGTH
68-0004	#5	7 in 175 mm

Exodontia Oral Double-Ended Curette



CODE	TIP	LENGTH
68-0225	#10	7¼ in 185 mm
68-0227	#12	7¼ in 185 mm
68-0228	#13	7¼ in 185 mm

Buck Ear Curette



CODE	SIZE	TIP	DIAMETER	LENGTH
62-1309	#00	Blunt, Slightly Angled Tip	1.0 mm	6 in 150 mm
62-1310	#0	Blunt, Slightly Angled Tip	1.5 mm	6 in 150 mm
62-1311	#1	Blunt, Slightly Angled Tip	2.0 mm	6 in 150 mm
62-1312	#2	Blunt, Slightly Angled Tip	2.5 mm	6 in 150 mm
62-1313	#3	Blunt, Slightly Angled Tip	3.0 mm	6 in 150 mm
62-1209	#00	Sharp, Slightly Angled Tip	1.0 mm	6 in 150 mm
62-1210	#0	Sharp, Slightly Angled Tip	1.0 mm	6 in 150 mm
62-1211	#1	Sharp, Slightly Angled Tip	2.0 mm	6 in 150 mm
62-1212	#2	Sharp, Slightly Angled Tip	2.5 mm	6 in 150 mm
62-1213	#3	Sharp, Slightly Angled Tip	3.0 mm	6 in 150 mm

Curettes (Ear)

62-1432



Shapleigh Ear Curette

CODE	DESCRIPTION	BLADE	LENGTH
62-1431	Small, Very Delicate	1.5 mm Serrated Loop	6 ½ in 165 mm
62-1432	Large, Very Delicate	2 mm Serrated Loop	6 ½ in 265 mm

Curettes (Ear, Elevator & Curette, Ear)

62-1470



Gross Ear Spoon & Hook

CODE	DESCRIPTION	LENGTH
62-1470	Double-Ended	4 ¾ in 120 mm

63-0409



Dunning Elevator & Curette

CODE	SIZE
63-0409	Sharp End 3 x 5 mm, Spatula End 3 mm

61-0015



Sprague Ear Curette

CODE	SIZE	TIP	LENGTH
61-0015	Small	2 mm	7 in 175 mm
61-0016	Large	3 mm	7 in 175 mm

Curettes (Frontal Sinus)

Frontal Sinus Curette

Small Oblong



63-8810

CODE	DESCRIPTION	CUP SIZE	LENGTH
63-8805	Straight	2x5 mm	7½ in 190 mm
63-8810	45° Angle	2x5 mm	7½ in 190 mm
63-8815	90° Angle	2x5 mm	7½ in 190 mm

Access Frontal Sinus Curette

With Swivel Luer



11-601

CODE	DESCRIPTION	ANGLE
11-601	Frontal Sinus	0°
11-651	Frontal Sinus	50°
11-691	Frontal Sinus	90°

Access Suction Curette



11-642S

CODE	DESCRIPTION
11-642S	45°
11-692S	90°

Curettes (Middle Ear)

Ethmoid Curette

CODE	DESCRIPTION	SIZE	LENGTH
63-0058	Curette	3 x 5 mm Cup	8 in 200 mm



Guilford-Wright Micro Curette

CODE	DESCRIPTION	ANGLE	CUP	LENGTH
61-0327	Small	Light Angle	1 mm Cup	5 ½ in 140 mm
61-0328	Medium	Light Angle	1.5 mm Cup	5 ½ in 140 mm
61-0329	Large	Strong Angle	2 mm Cup	5 ½ in 140 mm



61-0348

Hough Curette

CODE	DESCRIPTION	SIZE	LENGTH
61-0348	Angled 35°, Serrated Cup	2 x 3 mm	5 ½ in 140 mm

Curettes (Middle Ear)



61-0398

Halle Hough Curette

CODE	DESCRIPTION	SIZE	LENGTH	
61-0398	Lightly Angled	2 x 2.5 mm Cups	6 ½ in	165 mm
61-0399	Strongly Angled	2 x 2.5 mm Cups	6 ½ in	165 mm
61-0398E	Ebonized	2 x 2.5 mm Cups	6 ½ in	165 mm



Tip

House-Sheehy Knife Curette

Malleable Shaft

CODE	DESCRIPTION	BLADE	LENGTH	
61-0381	"Small Weapon"	2 mm	6 ½ in	165 mm
61-0382	"Large Weapon"	2.5 mm	6 ½ in	165 mm

House Stapes Curette

CODE	DESCRIPTION	SIZE	LENGTH	
61-0380	Double-Ended	1.7 mm and 2 mm	6 in	150 mm



Curettes (Middle Ear)



House Stapes Curette

CODE	DESCRIPTION	SIZE
61-3725	Double-Ended, Strong Angle	1.7 mm and 1.9 mm



61-3775

Paparella Ring Curette

CODE	DESCRIPTION	TIP	LENGTH
61-3775	Angled, Blunt	1.5 mm	6½ in 165 mm

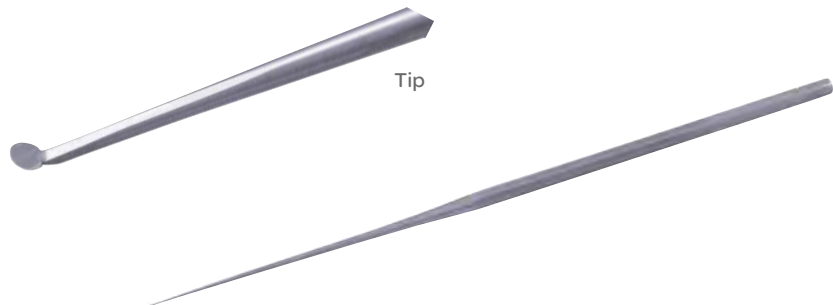

Rosen Knife Curette

CODE	DESCRIPTION	ANGLE	BLADE	LENGTH
61-0450	Small	Angled 45°	2 mm	6¼ in 160 mm
61-0451	Large	Angled 45°	2.5 mm	6¼ in 160 mm

Curettes (Sinus & Nasal)

Antrum Curette

Fenestrated Cup

CODE	DESCRIPTION	SIZE	LENGTH
63-7540	Backward Cut	7 x 10 mm Tip	7 ½ in 190 mm
63-7535	Forward Cut	7 x 10 mm Tip	7 ½ in 190 mm

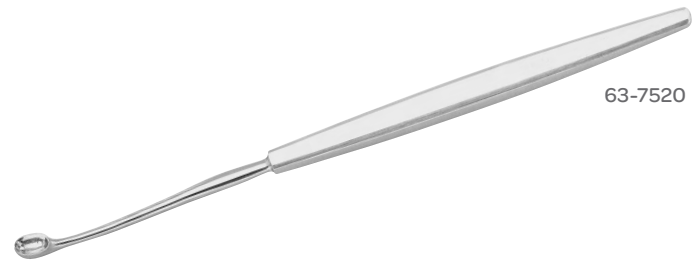

63-7520

Antrum Curette

CODE	DESCRIPTION	CUP	LENGTH
63-7512	Straight	3 x 9 mm	7 ½ in 190 mm
63-7505	Straight	7 x 11 mm	7 ½ in 190 mm
63-7515	Straight	8 x 11 mm	7 ½ in 190 mm
63-7520	Straight	9 x 13 mm	7 ½ in 190 mm
63-7510	Angled Up	1.5 x 6 mm	7 ½ in 190 mm



66-5801

Coakley Antrum Curette

Single-Ended

CODE	DESCRIPTION	LENGTH
66-5801	#1	6 ¾ in 170 mm
66-5802	#2	6 ¾ in 170 mm
66-5803	#3	6 ¾ in 170 mm
66-5804	#4	6 ¾ in 170 mm
66-5805	#5	6 ¾ in 170 mm
66-5806	#6	6 ¾ in 170 mm

Curettes (Sinus & Nasal)



Faulkner Antrum Curette

Double-Ended, Malleable Shaft

CODE	DESCRIPTION	LENGTH
63-7500	5 mm and 8 mm Rings	9 in 230 mm

Cutting Blocks

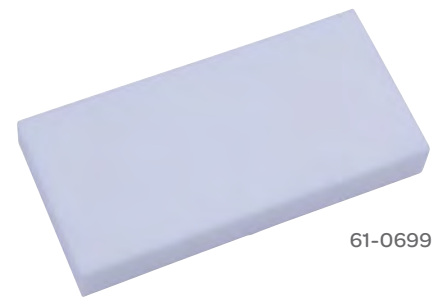

61-0699

Cutting Block

CODE	DESCRIPTION	WIDTH	LENGTH
61-0699	Teflon Cutting Block	1½ in 38 mm	3 in 76 mm

Dilators (Tracheal)



25-4002

Laborde Tracheal Dilator

CODE	DESCRIPTION	BLADES	JAW WIDTH	JAW THICKNESS	LENGTH
25-4002	Tri-Valve		$\frac{3}{16}$ in 5.0 mm	$\frac{1}{4}$ in 6.0 mm	6¾ in 170 mm
73-6604	Child	Three Blades, Two Flat, One Cupped			6¾ in 170 mm
73-6603	Adult	Three Blades, Two Flat, One Cupped			6¾ in 170 mm

Dilators (Tracheal)

Trousseau Tracheal Dilator



CODE	DESCRIPTION	BLADES	JAW WIDTH	JAW THICKNESS	LENGTH
73-6602	Adult	Two Blades, Curved			6 ³ / ₄ in 170 mm
73-6601	Child	Two Blades, Curved			6 ³ / ₄ in 170 mm
25-4000	Closed	Two Blades, Curved	¼in 6 mm	⅜in 5 mm	6 ³ / ₄ in 170 mm
25-5569	Closed	Two Blades, Curved	⅛in 3 mm	⅛in 3 mm	6 ³ / ₄ in 170 mm

Dissectors (Facial)

McCabe Facial Nerve Dissector

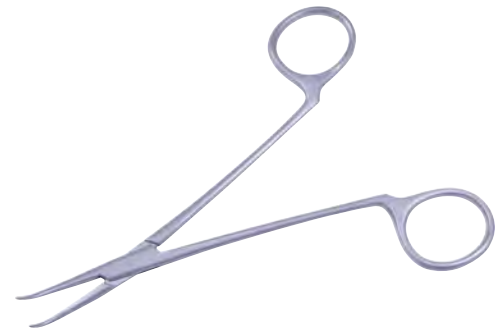

CODE	DESCRIPTION	JAW LENGTH	LENGTH
62-1585	Smooth Angled Jaws	14 mm	5½in 140 mm

McCabe Flap Knife Dissector

Double-Ended

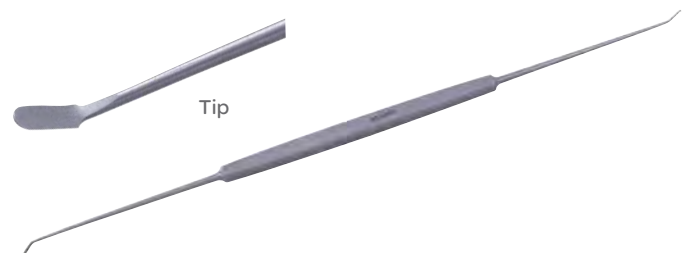

CODE	DESCRIPTION	BLADE	LENGTH
62-0480	Angled 25° and 45°	2 x 3 mm	7½in 185 mm

Elevators (Mastoid Hook & Searcher)



Allport Mastoid Hook & Searcher

CODE	DESCRIPTION	LENGTH
62-1520	Angled 90°	6¼ in 160 mm

Elevators (Middle Ear, Cleft Palate, Ball End)



Jordan Canal Elevator

CODE	DESCRIPTION	LENGTH
61-0416	2 mm Sharp Blade, Angled 60°	6½ in 165 mm



Blair Cleft Palate Elevator

CODE	DESCRIPTION	TIP	LENGTH
67-1749	Blair Cleft	L-Shaped	7½ in 190 mm

Elevators (Middle Ear, Cleft Palate, Ball End)

Cronin Cleft Palate Elevator



CODE	DESCRIPTION	TIP	LENGTH
67-1750	Small	4 x 9 mm	6 ¼ in 160 mm

Ball End Elevator



CODE	DESCRIPTION	LENGTH
66-5490	Curved	7 ½ in 190 mm

Austin Elevator



CODE	DESCRIPTION	TIP	LENGTH
61-0302	Knife Elevator, Angled 90°	2 mm Round	6 ¼ in 160 mm

Elevators (Middle Ear)



Guilford-Wright Drum Elevator

CODE	DESCRIPTION	TIP WIDTH	LENGTH
61-0323	Elevator	2 mm	5½ in 140 mm

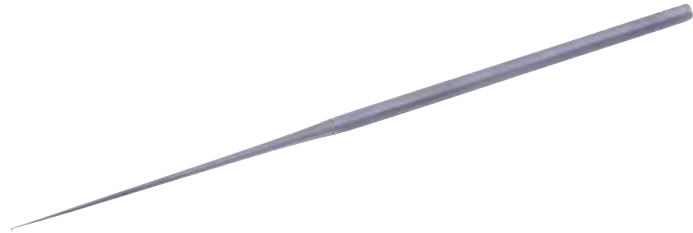

Paparella Drum Elevator

Double-Ended

CODE	DESCRIPTION	LENGTH
61-3710	Elevator Knife, #3	7¼ in 185 mm

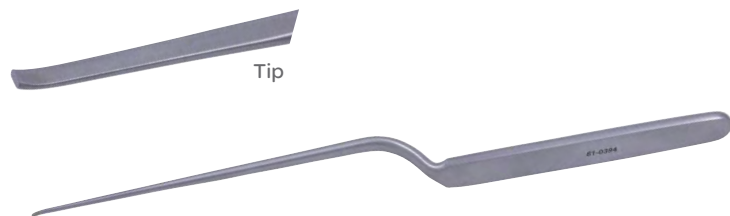

House Bayonet Elevator & Chisel

CODE	DESCRIPTION	TIP WIDTH	LENGTH
61-0394	Curved	1 mm	6¾ in 170 mm

Elevators (Middle Ear)

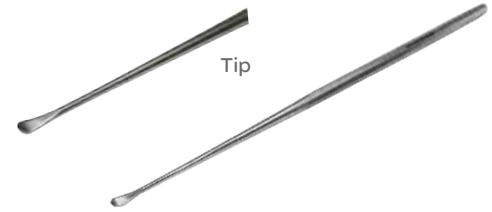

Paparella Duckbill Elevator

CODE	DESCRIPTION	LENGTH
61-0440	3.5 mm Curved Blade	6½ in 165 mm

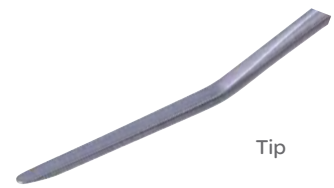

House "Gimmick" Elevator

CODE	DESCRIPTION	TIP	LENGTH
61-0376	15° Angle	1 x 12 mm	6½ in 165 mm

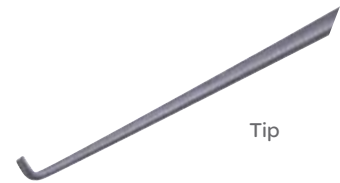

Hough "Hoe" Elevator

CODE	DESCRIPTION	TIP	LENGTH
61-0340	Angled Shaft, 90° Tip Angle	0.5 mm	6 in 150 mm

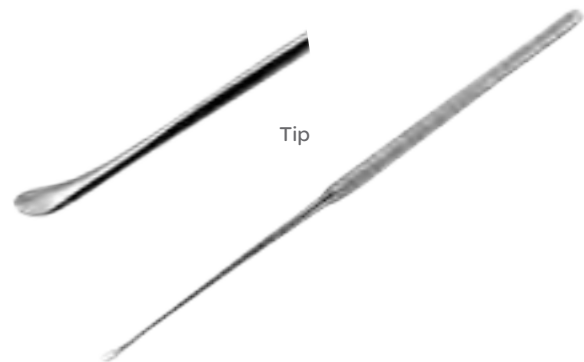

Austin Duckbill Knife Elevator

CODE	DESCRIPTION	TIP	LENGTH
61-0301	Curved Tip	2 x 8 mm	6¼ in 160 mm

Elevators (Middle Ear, Nasal)

Tabb Elevator

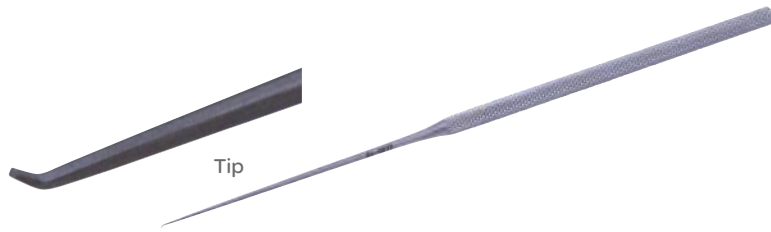

CODE	DESCRIPTION	BLADE	LENGTH
61-0272	45° Angle	1 mm	6½ in 165 mm

Elevators (Middle Ear, Nasal)

Boies Nasal Fracture Elevator



CODE	DESCRIPTION	TIP WIDTH	LENGTH
67-1570	Heavy Shaft, Blunt Edges	9 mm	7¾ in 195 mm

Freer Elevator



CODE	DESCRIPTION	TIP	LENGTH
55-7026	4.5 mm, Double-Ended	1 mm	7½ in 190 mm
55-7027	6.5 mm, Double-Ended	1 mm	7½ in 190 mm

Elevators (Periosteal, Septal, Skin)

Dingman Periosteal Elevator

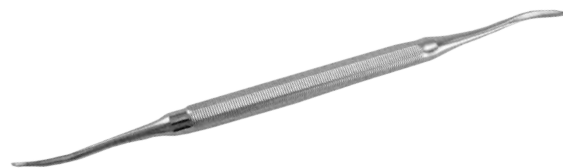

CODE	DESCRIPTION	LENGTH
68-0905	Double-Ended	7¼ in 185 mm

Elevators (Periosteal, Septal, Skin)

McKenty Periosteal Elevator



26-4224

CODE	DESCRIPTION	TIP	LENGTH
26-4224	Light Curve	4 mm Wide	6 in 150 mm
26-4225	Light Curve	5 mm Wide	6 in 150 mm

Molt Periosteal Elevator



CODE	DESCRIPTION	LENGTH
26-3703	Sharp/Blunt, Double-Ended	7 $\frac{1}{8}$ in 180 mm
26-3707	Sharp/Sharp, Double-Ended	7 $\frac{1}{8}$ in 180 mm

Obwegeser Periosteal Elevator

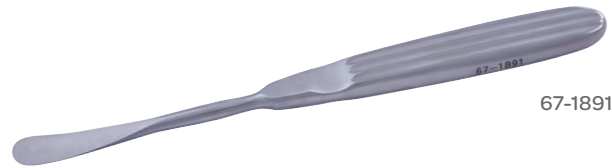

67-1891

CODE	DESCRIPTION	TIP	LENGTH
67-1890	Elevator	7 mm Wide	7 in 175 mm
67-1891	Elevator	11 mm Wide	7 in 175 mm

Seldin Periosteal Elevator

CODE	DESCRIPTION	LENGTH
68-0393	#23, Flat Handle	7 $\frac{3}{4}$ in 197 mm

Elevators (Septal)

Cottle Septum Elevator



CODE	DESCRIPTION	LENGTH
67-1623	Double-Ended with Graduations	8 ³ / ₄ in 220 mm

Goldman Septum Elevator

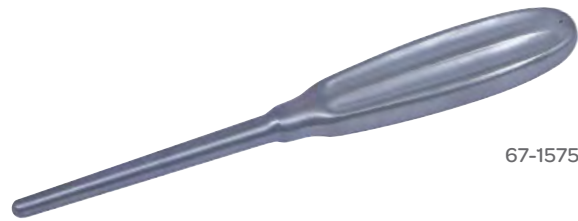

67-1575

CODE	DESCRIPTION	LENGTH
67-1575	Heavy Tapered Blade	7 ¹ / ₂ in 190 mm

Tebbets Septal Elevator



CODE	DESCRIPTION	LENGTH
67-1770	Elevator	8 ¹ / ₄ in 210 mm

Elevators (Skin)

Cottle Skin Elevator



67-1550

CODE	DESCRIPTION	LENGTH
67-1551	Blunt	7 ¹ / ₂ in 190 mm
67-1550	Sharp	7 ¹ / ₂ in 190 mm

Elevators (Zygoma)



Gillies Zygoma Elevator

CODE	TIP WIDTH	FROM ANGLE TO TIP	LENGTH
68-4510	9 mm	35 mm	9 in 230 mm

Alderdyce Elevator

CODE	DESCRIPTION	WIDTH	LENGTH
72-2530	Double-Ended, Sharp/Blunt	8 mm	8½ in 215 mm

Dingman Elevator

CODE	DESCRIPTION	LENGTH
68-0920	Curved	8¼ in 210 mm

Exodontia Elevator

CODE	DESCRIPTION	LENGTH
68-0298	#34S	6 in 150 mm

Elevators (Zygoma)

Hajek Ballenger Elevator

Double-Ended



CODE	DESCRIPTION	TIP	LENGTH
66-5430	Blunt, Semi-Sharp, Heavy	5 mm	7 ³ / ₄ in 197 mm



Lempert Elevator

CODE	DESCRIPTION	TIP	LENGTH
61-0514	Solid Handle, Curved Tip	7 mm	7 ¹ / ₄ in 185 mm



Lempert Elevator

CODE	DESCRIPTION	TIP	LENGTH
63-0401	Small with Slight Curve	2 mm	6 ³ / ₄ in 170 mm
63-0402	Small with Slight Curve	3 mm	6 ³ / ₄ in 170 mm

McCulloch Elevator

CODE	DESCRIPTION	TIP	LENGTH
66-6500	Semi-sharp	3 mm	7 ¹ / ₂ in 190 mm

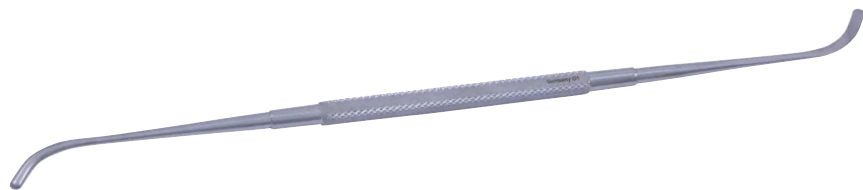

Elevators (Zygoma)



Pennington Elevator

CODE	DESCRIPTION	TIPS	LENGTH
66-5450	Double-Ended	6 x 9 mm and 6 x 11 mm	8½ in 215 mm

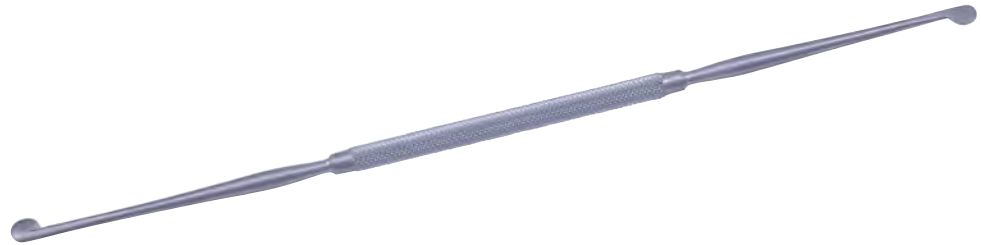

Pierce Elevator

CODE	DESCRIPTION	LENGTH
66-5455	Double-Ended, Right and Left Blade	7½ in 190 mm



Rogers Elevator

CODE	DESCRIPTION	LENGTH
66-5500	Curved, Double-Ended, Semi-Sharp Blades	8¼ in 210 mm

Energy (Energy Accessories)



Bipolar Cords

Reusable, Sold Individually

87006

CODE	DESCRIPTION	PLUG	LENGTH
87006	Shrouded Instrument Connector	Fixed-Pin Generator	12 ft 3.6 m
87110	European Flat Instrument Connector	Fixed-Pin Generator	12 ft 3.6 m
50-1106	45° Angled Instrument Connector	Fixed-Pin Generator	12 ft 3.6 m
87600	Bicomatic Instrument Connector	Wolf-Style Generator	12 ft 3.6 m



Bipolar Cords

Single-Use, 10 per Box, Sterile

40-1105

CODE	DESCRIPTION	PLUG	LENGTH
40-1105	Straight Instrument Connector	Fixed-Pin Generator	12 ft 3.6 m
40-1107	Straight Instrument Connector	Fixed-Pin Generator	12 ft 3.6 m
40-1106	45° Angled Instrument Connector	Fixed-Pin Generator	12 ft 3.6 m
40-1114	Wolf-Style Instrument Connector	Wolf-Style Generator	12 ft 3.6 m
40-1115	Wolf-Style Instrument Connector	Valleylab-Style Generator	12 ft 3.6 m



20003

Monopolar Cords

Reusable, 1 Each

CODE	DESCRIPTION	PLUG	LENGTH
20002	2.0 mm European-Style Recessed Pin Female	$\frac{5}{32}$ in (4.0 mm) Male Generator	10 ft 3.0 m
20003	TUR/Resectoscope Female	Valleylab-Style Male Generator	10 ft 3.0 m
20006	2.0 mm European-Style Recessed Pin Female	Valleylab-Style Male Generator	10 ft 3.0 m

Energy (Energy Accessories)



Monopolar Cords

Reusable, Sold Individually

50-2107

CODE	DESCRIPTION	PLUG	LENGTH
90018	Olsen® Threaded Instrument Connector	5/32 in (4.0 mm) Male Generator	10 ft 3.0 m
90020	Olsen® Threaded Instrument Connector	Valleylab-Style Male Generator	10 ft 3.0 m
90054	Laparoscopic Instrument Connector	5/32 in (4.0 mm) Male Generator	10 ft 3.0 m
90056	Laparoscopic Instrument Connector	Valleylab-Style Male Generator	10 ft 3.0 m
90065	Snare Female	5/32 in (4.0 mm) Male Generator	10 ft 3.0 m
90067	3.0 mm Olympus-Style Snare Connector	Valleylab-Style Male Generator	10 ft 3.0 m
50-2107	Endoscopic Instrument Connector, Angled 90°	Valleylab-Style Male Generator	10 ft 3.0 m
50-2111	Endoscopic Instrument Connector, Straight	Valleylab-Style Male Generator	10 ft 3.0 m



Monopolar Cords

Single-Use, 10 per Box, Sterile

40-2106

CODE	DESCRIPTION	PLUG	LENGTH
40-2110	Endoscopic Instrument Connector, Straight	Valleylab-Style Generator	10 ft 3.0 m
40-2106	Endoscopic Instrument Connector, Angled 90°	Valleylab-Style Generator	10 ft 3.0 m

Anesthesia Circuit Shield

Laser Safety Product, 6 per Box

CODE	DESCRIPTION	SIZE
60-7100	Laser Safety Product	12 x 48 in 30.5 x 122 mm

Energy (Energy Accessories)



77005

Holster Electrosurgical Accessory

Single-Use, 50 per Box, Sterile

CODE	DESCRIPTION
77005	with Metal Clip
77006	with Tip Cleaner and Metal Clip
77000	with Tip Cleaner
77001	



Binocular Eye Shield

Single-Use, Laser Safety Product

CODE	DESCRIPTION	QTY
60-7000-OL	Eye Shield	12/Box

Personnel Shield

Single-Use, Drapes Between Sterile Field and Anesthesiologist, 6 per Box

CODE	DESCRIPTION	SIZE
60-7200	Drapes Between Sterile Field and Anesthesiologist	30 x 60 in 762 x 1524 mm

Energy (Energy Accessories)



97500

ProClean™ Tip Cleaning Pad with Adhesive Back

Single-Use, Sterile

CODE	DESCRIPTION	QTY
97500	with Adhesive Back Electrosurgical Accessory	50/Box
97501	with Adhesive Back Electrosurgical Accessory	144/ Box

Energy (Monopolar Adapters, Electrode)



96000

Monopolar Generator Adapter

Electrosurgical Accessory, Male, Reusable, Sold Individually

CODE	DESCRIPTION	WIRE
96000	$\frac{5}{32}$ in (4.0 mm)	Crimped Wire $\frac{1}{8}$ in (3.2 mm) Female
96001	Valleylab-Style	Crimped Wire $\frac{1}{8}$ in (3.2 mm) Female
96200	Valleylab-Style	European/Wolf-Style Female

EAR, NOSE & THROAT



68600

Nasal Needle Electrode

Reusable, Sold Individually

CODE	DESCRIPTION	LENGTH
68603	6.0 mm Exposure	8 in 203 mm
68601	15 mm Exposure	8 in 203 mm
68602	50 mm Exposure	8 in 203 mm
68600	102 mm Exposure	8 in 203 mm

Energy (Bayonet Monopolar Forceps)

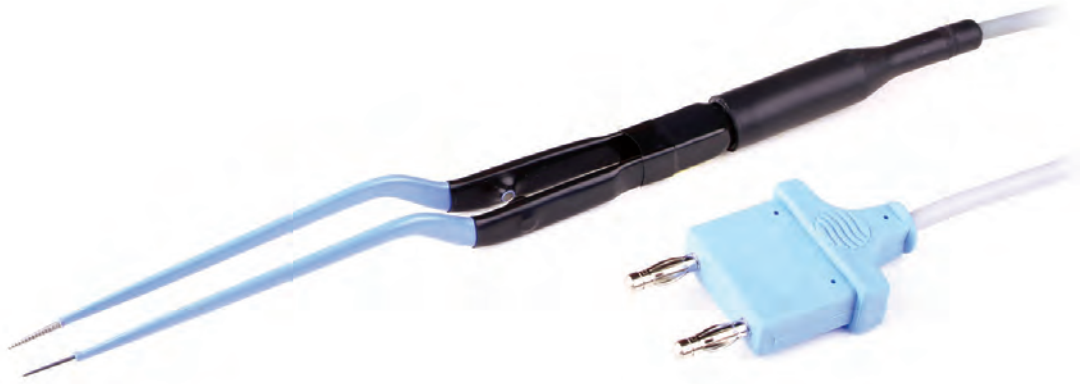

Bayonet Monopolar Forceps, Hand-Controlled

Reusable, Serrated Tips, Insulated with 10 ft (3.0 m) Attached Cord, 1 Each

Length (L)	6½ in 165 mm	8¼ in 210 mm	7½ in 191 mm	7½ in 191 mm
Working (WL)	3¼ in 83 mm	7½ in 191 mm	3¾ in 95 mm	3¾ in 950 mm
TIP SIZE	SERRATED TIP	SERRATED TIP	STRAIGHT	CATHEDRAL
0.5 mm	11104	11605	11206	11213
1.0 mm	11102	11604	11205	11212
1.5 mm	11101	11602	11204	11210
2.0 mm	11100	11600	11200	11208

Energy (Reusable Bipolar Forceps)



10-1445I

Bayonet Bipolar Forceps, Angled Up

Reusable, Smooth Tips, 1 Each

Length (L)	8¼ in 210 mm	10½ in 267 mm	8¼ in 210 mm	10½ in 267 mm
Working (WL)	4¼ in 108 mm	6¼ in 159 mm	4¼ in 108 mm	6¼ in 159 mm
TIP SIZE	NON-INSULATED	NON-INSULATED	INSULATED	INSULATED
1.0 mm	10-1445	10-1482	10-1445I	10-1482I
1.5 mm	10-1447	10-1486	10-1447I	10-1486I
2.0 mm	10-1449	10-1488	10-1449I	10-1488I

Energy (Reusable Bipolar Forceps)

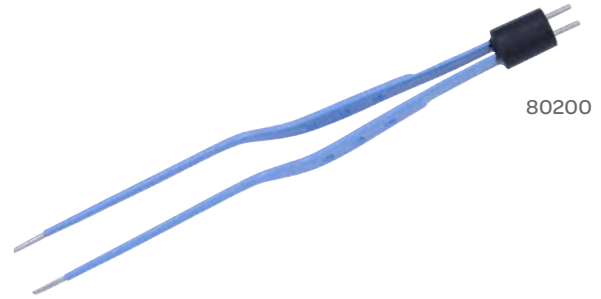

80200

Bayonet Bipolar Forceps, Insulated

Reusable Smooth Tip, Sold Individually

Length (L)	6½ in 165 mm	7½ in 190 mm	7¾ in 197 mm	8⅝ in 219 mm	12 in 305 mm
Working (WL)	2¾ in 70 mm	3 in 76 mm	3⅝ in 92 mm	4½ in 114 mm	7⅞ in 200 mm

TIP SIZE	INSULATED	INSULATED	INSULATED	INSULATED	INSULATED
micro	80205	80304			
0.5 mm	80204	80303	80434	80574	
0.75 mm			80433	80573	
1.0 mm	80202	80302			80582
1.2 mm			80432	80572	
1.5 mm	80201	80301	80431	80571	80581
2.0 mm	80200	80300	80430	80570	80580

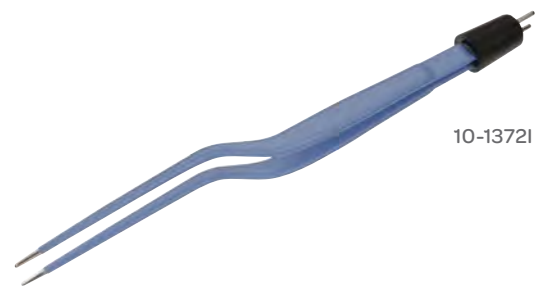

10-1372I

Bayonet Bipolar Forceps, Insulated

Reusable Smooth Tip, Sold Individually

Length (L)	6¼ in 159 mm	7⅛ in 181 mm	8¼ in 210 mm	10½ in 267 mm
Working (WL)	2¾ in 70 mm	2¾ in 70 mm	4½ in 108 mm	6¼ in 159 mm

TIP SIZE	INSULATED	INSULATED	INSULATED	INSULATED
0.5 mm	10-1311I	10-1360I	10-1421I	10-1483I
0.75 mm	10-1321I	10-1361I	10-1401I	10-1485I
1.0 mm	10-1322I	10-1362I	10-1431I	10-1481I
1.5 mm	10-1331I	10-1371I	10-1411I	10-1484I
2.0 mm		10-1372I	10-1412I	10-1487I

Energy (Reusable Bipolar Forceps)

Gerald Bipolar Forceps

Reusable, Smooth Tips, 1 Each

CODE	DESCRIPTION	TIP SIZE	LENGTH
10-1180I	Forceps, Insulated	1.0 mm	7¼ in 184 mm



Cushing Bayonet Bipolar Forceps

Reusable, 1 Each

CODE	DESCRIPTION	TIP SIZE	LENGTH
08-0000I	Forceps, Insulated	0.7 mm	7½ in 191 mm
08-0026I	Forceps, Insulated	1.0 mm	7½ in 191 mm
08-0027I	Forceps, Insulated	1.5 mm	7½ in 191 mm



08-0000

Cushing Bipolar Forceps

Reusable, Smooth Tips, 1 Each

CODE	DESCRIPTION	TIP SIZE	LENGTH
10-1160I	Forceps, Insulated	1.0 mm	7 in 178 mm
10-1162I	Forceps, Insulated	1.5 mm	7 in 178 mm

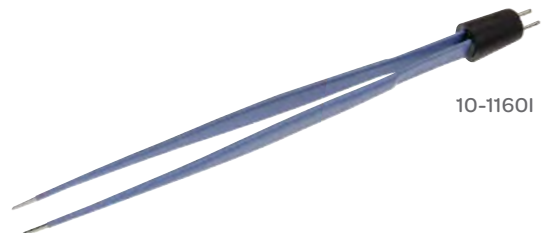

10-1160I

Energy (Reusable Bayonet Forceps)

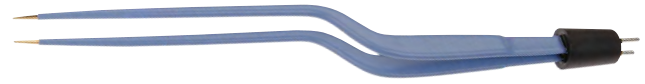

90-7004

Bayonet Bipolar Forceps, Midas Touch® Non-Stick

Reusable Smooth Tip, Insulated

Length (L)	7 3/4 in 197 mm	8 5/8 in 219 mm	10 1/2 in 267 mm
Working (WL)	3 5/8 in 92 mm	4 3/8 in 111 mm	6 1/4 in 159 mm

TIP SIZE	INSULATED	INSULATED	INSULATED
0.5 mm	90-7004	90-8012	90-9008
0.75 mm	90-7000	90-8000	90-9007
1.2 mm	90-7005	90-8013	90-9006
1.5 mm	90-7001	90-8001	90-9005
2.0 mm	90-7006	90-8003	90-9009



90-8007

K-Style Standard Angle Bayonet Bipolar Forceps, Curved Up

Reusable, Smooth Tip, Midas Touch® Non-Stick Tips, 1 Each

Length (L)	8 5/8 in 219 mm	9 1/2 in 229 mm	Length (L)	8 5/8 in 219 mm	9 1/2 in 229 mm
Working (WL)	4 1/2 in 114 mm	5 1/8 in 130 mm	Working (WL)	4 1/2 in 114 mm	5 1/8 in 130 mm

TIP SIZE	INSULATED	INSULATED	TIP SIZE	INSULATED	INSULATED
0.5 mm	90-8017	90-9509	0.5 mm		
0.75 mm	90-8018	90-9510	0.75 mm		
1.0 mm	90-8007	90-9502	1.0 mm	90-8009	90-9505



90-8006

K-Style Standard Angle Bayonet Bipolar Forceps, Straight

Reusable, Smooth Tip, Midas Touch® Non-Stick Tips, 1 Each

Length (L)	8 5/8 in 219 mm	9 1/2 in 229 mm	10 1/2 in 267 mm
Working (WL)	4 1/2 in 114 mm	5 1/8 in 130 mm	6 1/4 in 159 mm

TIP SIZE	INSULATED	INSULATED	INSULATED
0.5 mm	90-8015	90-9507	
0.75 mm	90-8016	90-9508	
1.0 mm	90-8006, 90-8008	90-9501, 90-9504	90-9001
1.5 mm		90-9500	90-9000

Energy (Reusable Bipolar Forceps)

Potts-Smith Bipolar Forceps

Reusable, Smooth Tips, 1 Each

CODE	DESCRIPTION	TIP SIZE	LENGTH
80404	Forceps, Insulated	Micro	7¼ in 184 mm
80403	Forceps, Insulated	0.5 mm	7¼ in 184 mm
80402	Forceps, Insulated	1.0 mm	7¼ in 184 mm
80401	Forceps, Insulated	1.5 mm	7¼ in 184 mm
80400	Forceps, Insulated	2.0 mm	7¼ in 184 mm

Scoville-Greenwood Bayonet Bipolar Forceps

Reusable, 1 Each

CODE	DESCRIPTION	TIP SIZE	LENGTH
08-0030	Forceps, Non-Insulated	1.5 mm	7½ in 191 mm
08-0092	Forceps, Non-Insulated	1.5 mm	7 in 178 mm
08-0028I	Forceps, Insulated	0.25 mm	7¾ in 197 mm
08-0030I	Forceps, Insulated	1.5 mm	7½ in 191 mm



08-0092

Semkin Bipolar Forceps

Reusable, Smooth Tips, 1 Each

CODE	DESCRIPTION	TIP SIZE	LENGTH
10-1091I	Forceps, Insulated	0.75 mm	5½ in 140 mm
10-1191I	Forceps, Insulated	1.0 mm	5½ in 140 mm
90-3000	Midas Touch Non-Stick, Insulated	0.75 mm	5¾ in 146 mm

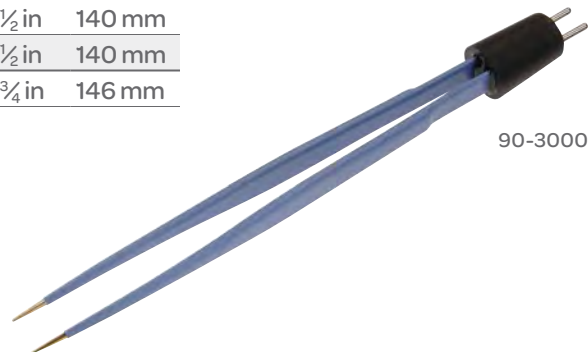

90-3000

Energy (Single-Use Bipolar Forceps)

Adson Bipolar Forceps, Smooth Tip

10 per Box

CODE	DESCRIPTION	TIP SIZE	LENGTH	
20-1082I	Forceps, Insulated	1.0 mm	5 in	127 mm
20-1082KI	Kit, Insulated	1.0 mm	5 in	127 mm



90-3000

Single-Use Bayonet Bipolar Forceps, Acute Angle

Smooth Tips, 10 per Box

Length (L)	7 1/2 in	191 mm	7 1/2 in	191 mm
Working (WL)	4 1/8 in	105 mm	4 1/8 in	105 mm

TIP SIZE	FORCEPS, INSULATED	KIT, INSULATED
0.75 mm	20-1530I	20-1530KI
1.0 mm	20-1540I	
1.5 mm	20-1550I	20-1550KI

Single-Use Bayonet Bipolar Forceps, Acute Angle

Smooth Tips, 10 per Box

Length (L)	8 3/8 in	213 mm	8 3/8 in	213 mm	8 3/8 in	213 mm	8 3/8 in	213 mm
Working (WL)	5 1/8 in	130 mm	5 1/8 in	130 mm	5 1/8 in	130 mm	5 1/8 in	130 mm

TIP SIZE	FORCEPS, NON-INSULATED	FORCEPS, INSULATED	KIT, NON-INSULATED	KIT, INSULATED
0.75 mm				20-1560KI
1.0 mm	20-1570	20-1570I	20-1570K	20-1570KI
1.5 mm	20-1580		20-1580K	

Energy (Single-Use Bipolar Forceps)



20-1482I

Single-Use Bayonet Bipolar Forceps, with Midas Touch® Non-Stick Tips

5 per Box

Length (L)	6¼ in 159 mm	7½ in 191 mm
Working (WL)	3¾ in 95 mm	3 in 70 mm
TIP SIZE	INSULATED	INSULATED
0.5 mm	20-1315IMT	20-1386IMT
0.75 mm	20-1320IMT	20-1384IMT
1.0 mm	20-1325IMT	20-1382IMT
1.5 mm	20-1330IMT	20-1380IMT



20-1482I

Single-Use Bayonet Bipolar Forceps, Angled Up

Smooth Tips, 10 per Box

Length (L)	10½ in 267 mm	10½ in 267 mm
Working (WL)	6 in 152 mm	6 in 152 mm
TIP SIZE	FORCEPS, INSULATED	KIT, INSULATED
1.0 mm	20-1682I	20-1682KI-28



20-1320

Single-Use Bayonet Bipolar Forceps

Smooth Tips, 10 per Box

Length (L)	6¼ in 159 mm	6¼ in 159 mm	6¼ in 159 mm
Working (WL)	3¾ in 95 mm	3¾ in 95 mm	3¾ in 95 mm
TIP SIZE	FORCEPS, INSULATED	KIT, NON-INSULATED	KIT, INSULATED
0.5 mm	20-1315I	20-1315K	20-1315KI
0.75 mm	20-1320I	20-1320K	20-1320KI
1.0 mm	20-1325I	20-1325K	20-1325KI
1.5 mm	20-1330I	20-1330K	20-1330KI

Energy (Single-Use Bipolar Forceps)

Single-Use Bayonet Bipolar Forceps

Smooth Tips, 10 per Box

20-1370



Length (L)	7 1/8 in 181 mm	7 1/8 in 181 mm
Working (WL)	2 3/4 in 70 mm	2 3/4 in 70 mm

TIP SIZE	FORCEPS, INSULATED	KIT, INSULATED
0.5 mm	20-1355I	20-1355KI
0.75 mm	20-1360I	20-1360KI
1.0 mm	20-1340I	20-1340KI
1.5 mm	20-1370I	20-1370KI
2.0 mm	20-1375I	20-1375KI

Single-Use Bayonet Bipolar Forceps

Smooth Tips, 10 per Box

20-1380I



Length (L)	7 1/2 in 191 mm	7 1/2 in 191 mm
Working (WL)	3 in 76 mm	3 in 76 mm

TIP SIZE	FORCEPS, INSULATED	KIT, INSULATED
0.5 mm	20-1386I	
0.75 mm	20-1384I	
1.0 mm	20-1382I	20-1382KI
1.5 mm	20-1380I	20-1380KI

Single-Use Bayonet Tonsil Bipolar Forceps

Smooth Tips, Angled Down, Insulated, 10 per Box



Length (L)	7 1/2 in 191 mm	7 1/2 in 191 mm
Working (WL)	3 in 76 mm	3 in 7.6 mm

TIP SIZE	FORCEPS, INSULATED	KIT, INSULATED
1.5 mm	20-1381I	20-1381KI-28

Energy (Single-Use Bipolar Forceps)

Single-Use Gerald Bipolar Forceps

Smooth Tips, 10 per Box

CODE	DESCRIPTION	TIP SIZE	LENGTH
20-1180	Forceps, Non-Insulated	1.0 mm	7¼ in 184 mm
20-1180I	Forceps, Insulated	1.0 mm	7¼ in 184 mm
20-1180K	Kit, Non-Insulated	1.0 mm	7¼ in 184 mm
20-1180KI	Kit, Insulated	1.0 mm	7¼ in 184 mm



20-1180

Single-Use Semkin Bipolar Forceps

Smooth Tips, 10 per Box

CODE	DESCRIPTION	TIP SIZE	LENGTH
20-1090I	Forceps, Insulated	0.75 mm	5¾ in 146 mm
20-1190I	Forceps, Insulated	1.0 mm	5½ in 140 mm
20-1090KI	Kit, Insulated	0.75 mm	5¾ in 146 mm
20-1190KI	Kit, Insulated	1.0 mm	5½ in 140 mm



20-1090

Single-Use Semkin Bipolar Forceps

Midas Touch® Non-Stick, 5 per Box

CODE	DESCRIPTION	TIP SIZE	LENGTH
20-1090IMT	Forceps, Insulated	0.75 mm	5¾ in 146 mm



Excavators (Middle Ear)

House "Hoe" Excavator

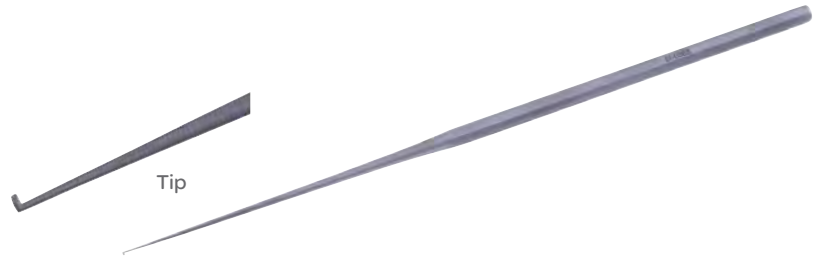

CODE	DESCRIPTION	TIP	LENGTH
61-0363	Straight Shaft, Angled 90°	0.5 mm	6 ½ in 165 mm

Austin Excavator



CODE	DESCRIPTION	TIP	LENGTH
61-0303	Angled Right	0.75 mm	6 ¼ in 160 mm
61-0304	Angled Left	0.75 mm	6 ¼ in 160 mm

Foot Plate Hooks (Middle Ear)

Austin Foot Plate Hook

CODE	DESCRIPTION	TIP WIDTH	LENGTH
61-0319	Angled 90°	0.33 mm	6 ¼ in 160 mm
61-0321	Angled 90°	0.50 mm	6 ¼ in 160 mm



Forceps (Alligator)

Bellucci Alligator Forceps

Finely Serrated, 8 mm Jaw

CODE	DESCRIPTION	LENGTH
61-0132	75 mm Shaft	5¼ in 135 mm



Goodhill Alligator Forceps

CODE	DESCRIPTION	LENGTH
61-0136	75 mm Shaft	5¼ in 135 mm



Hartmann Alligator Forceps

CODE	DESCRIPTION	LENGTH
61-0127	Serrated Extra Delicate	3½ in 90 mm



Forceps (Biopsy)

Biopsy Forceps

Double-Action, 2 x 3 Cups, 9 mm Shaft

CODE	SHAFT	LENGTH
63-5703	Straight	6¼ in 160 mm
63-5701	Curved Up 70°	6¼ in 160 mm
63-5702	Curved Up 110°	6¼ in 160 mm

Forceps (Biopsy)

Punch Biopsy Forceps

Single Action Thru-Biting, 1.5 x 3 mm Bite

CODE	DESCRIPTION	LENGTH
63-5706	Straight	7¼ in 185 mm
63-5704	70° Long Curve	7¼ in 185 mm
63-5705	70° Short Curve	7¼ in 185 mm



Roberts Biopsy Forceps

CODE	DESCRIPTION	WORKING LENGTH
74-5936	6 mm Cup	16 in 400 mm

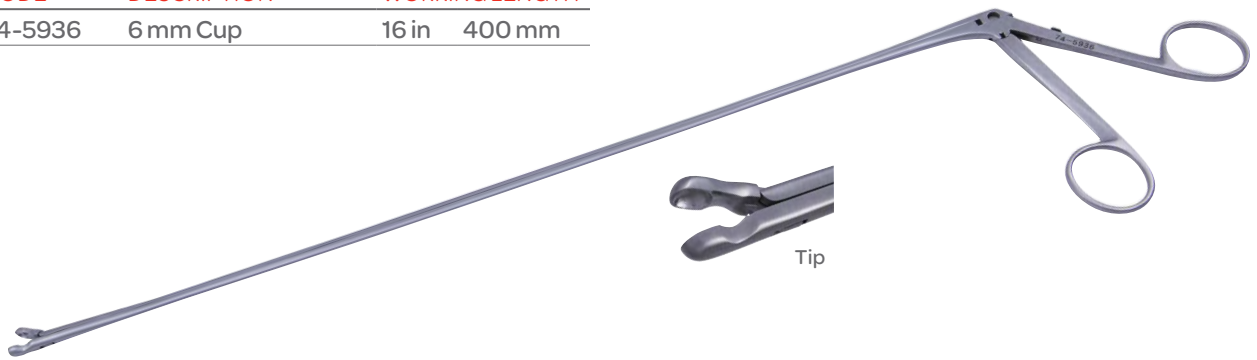

EAR, NOSE & THROAT

Forceps (Biting)

Cottle-Kazanjian Cutting Forceps

Angled

CODE	BLADE	LENGTH
33-0418	29 mm	7⅞ in 180 mm



Forceps (Crimper)

Juers Crimper Forceps

75 mm Shaft, Delicate 6 mm Jaws

CODE	JAWS	LENGTH
61-0133	Bayonet Left	5¼ in 135 mm
61-0134	Bayonet Right	5¼ in 135 mm

Scheer Crimper Forceps

Single Lengthwise Groove in Lower Jaw, 75 mm Shaft

CODE	JAWS	LENGTH
61-0145	5 mm, Smooth	5¼ in 135 mm



Forceps (Cutting)

Kleinsasser Cutting Forceps

Heavy Model

CODE	JAWS	WORKING LENGTH	LENGTH
74-6047	2.5 mm Diameter, 5 mm Cup	9 in 230 mm	5¼ in 135 mm

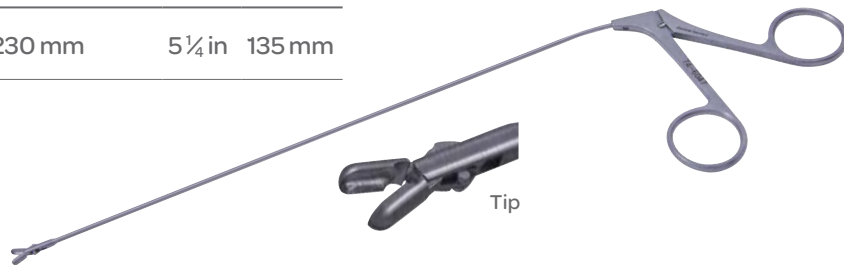

Forceps (Double-Spoon)

Double-Spoon Forceps

CODE	DESCRIPTION
66-2599	Pear Jaws, 100°

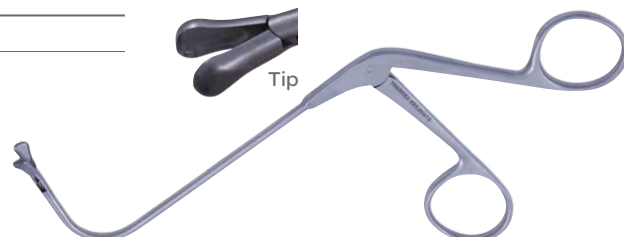

Forceps (Double Spoon)

Giraffe Polyp Forceps

CODE	DESCRIPTION
63-0569	Pear-Shaped, 80°

Forceps (Dressing)

Wilde Dressing Forceps

CODE	DESCRIPTION	LENGTH
61-0108	Serrated Tip, Delicate Pattern	5 3/4 in 145 mm

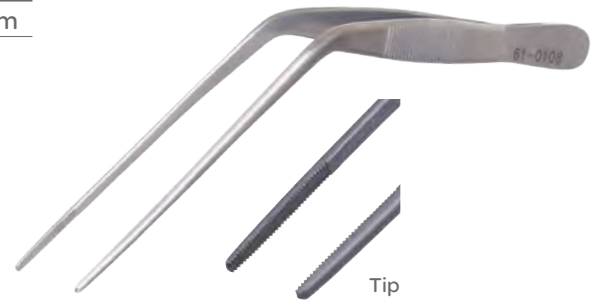

Forceps (Ear)

Hartmann Ear Forceps

CODE	DESCRIPTION	JAWS	LENGTH
61-0111	Delicate	3 x 6 mm	5 1/2 in 140 mm

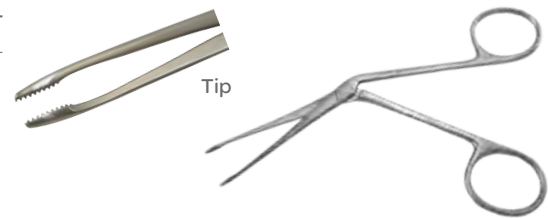

Hartman-Herzfeld Forceps

CODE	DESCRIPTION	LENGTH
61-0121	2 mm Cup, Straight 6 mm Jaws on 71 mm Shaft	5 1/4 in 135 mm
61-0122	3 mm Cup, Straight 6 mm Jaws on 71 mm Shaft	5 1/4 in 135 mm
61-0123	2 mm Cup, Up Biting on 71 mm Shaft	5 1/4 in 135 mm



Forceps (Ear)

Hartmann-Herzfeld Ear Forceps

2mm Cup, Up Biting, 6 mm

CODE	DESCRIPTION	LENGTH
61-0123	71 mm Shaft	5 ¼ in 135 mm
61-0123E	Ebonized	5 ¼ in 135 mm

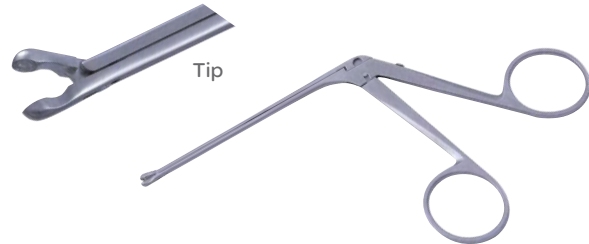

Hartmann Ear Forceps

Angular, Serrated

CODE	TIP SIZE	LENGTH
30-6951	⅜ in 7.6 mm	3 ½ in 89 mm

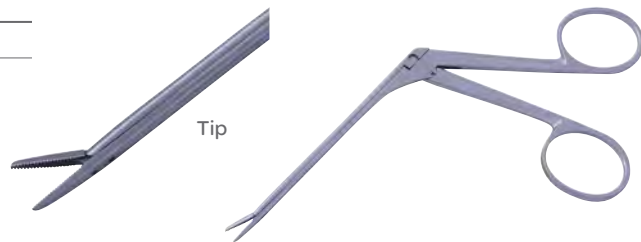

Lucae Bayonet Dressing Forceps

CODE	DESCRIPTION	LENGTH
07-3074	Serrated, Delicate	5 ¾ in 145 mm

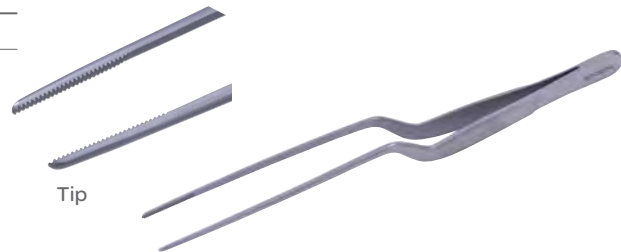

Lucae Ear Forceps

Bayonet Shape

CODE	WORKING DISTANCE	TIP WIDTH	LENGTH
30-6898	2 ¾ in 70 mm	2 mm	5 ½ in 140 mm

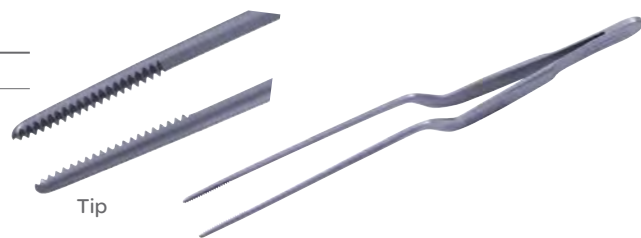

Noyes Ear Forceps

77 mm Shaft

CODE	JAWS	LENGTH
61-0116	Regular, 6 mm, Serrated	5 ½ in 140 mm
61-0118	Flat, 8 mm, Serrated	5 ¼ in 135 mm



Forceps (Ear)

Struempel Ear Forceps

75 mm Shaft, Fenestrated Oval Spoon

CODE	JAWS	LENGTH
61-0120	2.5 x 6 mm	5 1/2 in 140 mm

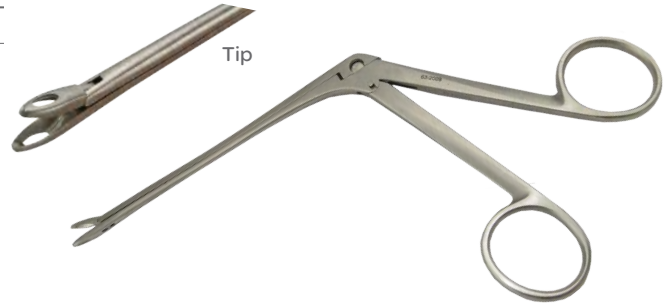

Tobey Ear Forceps

Very Delicate

CODE	JAWS	LENGTH
61-0113	2 x 4 mm, Serrated	5 1/2 in 140 mm



Weingartner Ear Forceps

75 mm Shaft

CODE	JAWS	LENGTH
61-0119	3 x 7 mm, Serrated	5 1/4 in 135 mm

Forceps (Ear Micro)

Micro Alligator Forceps

Straight

CODE	JAWS	LENGTH
58-4630	3 mm	7 1/4 in 185 mm

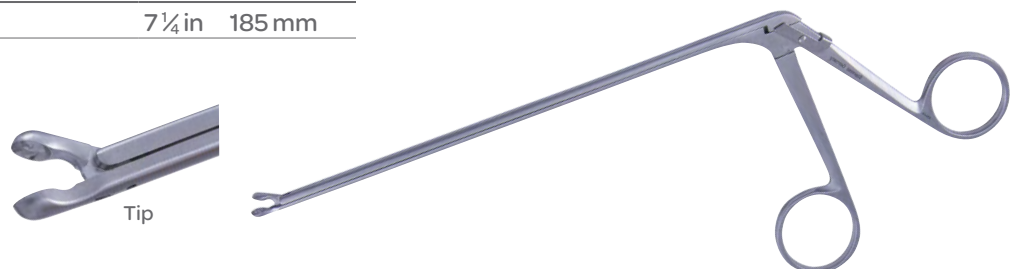

EAR, NOSE & THROAT

Forceps (Frontal Sinus)

Frontal Sinus Giraffe Forceps

Double Action Cupped Forceps

CODE	DESCRIPTION	ANGLES	LENGTH
63-8845	2 mm Jaws	45° Horizontal	5¼ in 135 mm
63-8865	2 mm Jaws	90° Horizontal	5¼ in 135 mm
63-8870	2 mm Jaws	90° Vertical	5¼ in 135 mm
63-8855	3 mm Jaws	45° Horizontal	5¼ in 135 mm
63-8850	3 mm Jaws	45° Vertical	5¼ in 135 mm
63-8875	3 mm Jaws	90° Horizontal	5¼ in 135 mm
63-8880	3 mm Jaws	90° Vertical	5¼ in 135 mm



63-8845

Forceps (Laryngeal)

Jackson Laryngeal Forceps

CODE	DESCRIPTION	LENGTH
74-5757	Angled Up, 4 mm Cup	8 in 200 mm



Tip

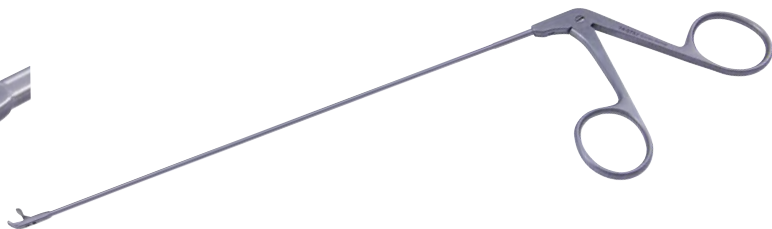

Jackson Laryngeal Forceps Alligator Forceps

Standard Jaws, Deep Serrations and Grooves

CODE	JAWS	WORKING LENGTH
74-5800	4 x 22 mm	280 mm
74-5801	4 x 22 mm	350 mm



Tip



Forceps (Cup)

Jackson Laryngeal Forceps Cup Forceps

Angled Up

CODE	DESCRIPTION	CUP SIZE	WORKING LENGTH
74-5718	Extra Lightweight Construction	2 mm	280 mm
74-5717	Extra Lightweight Construction	2 mm	280 mm
74-5706	Standard	4 mm	280 mm
74-5710	Standard	6 mm	200 mm



Tip

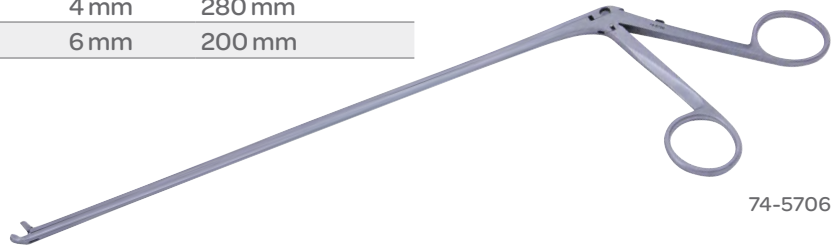

74-5706

Jackson Laryngeal Forceps Cup Forceps

Straight

CODE	DESCRIPTION	CUP SIZE	WORKING LENGTH
74-5715	Extra Lightweight Construction	2 mm	200 mm
74-5716	Extra Lightweight Construction	2 mm	280 mm
74-5700	Standard	4 mm	280 mm
74-5708	Standard	6 mm	280 mm



Tip

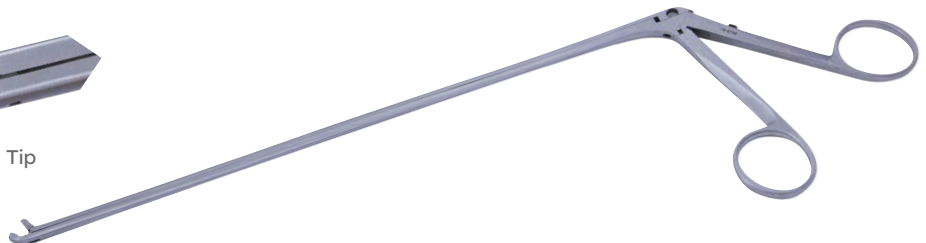

Forceps (Maxillary)

Rowe Maxillary Disimpaction Forceps

CODE	DESCRIPTION	LENGTH
68-5001	Left	9½ in 240 mm
68-5002	Right	9½ in 240 mm



68-5002

Forceps (Cup)

Jako Micro Laryngeal Cup Forceps

CODE	DESCRIPTION	ROUND CUPS	LENGTH
74-5925	Straight	2 mm	9¼ in 235 mm
74-5926	Curved Left	2 mm	9¼ in 235 mm
74-5927	Curved Right	2 mm	9¼ in 235 mm
74-5928	Curved Up	2 mm	9¼ in 235 mm

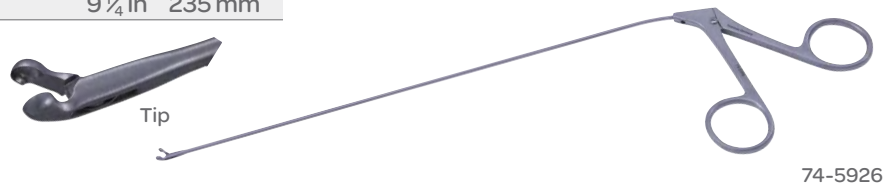

Forceps (Micro Laryngeal Cup)

Jako-Kleinsasser Micro Laryngeal Cup Forceps

Extremely Delicate

CODE	DESCRIPTION	CUPS	LENGTH
74-5960	Straight	1 mm	8⅝ in 220 mm
74-5964	Angled Left	1 mm	8⅝ in 220 mm
74-5962	Angled Right	1 mm	8⅝ in 220 mm
74-5963	Angled Up	1 mm	8⅝ in 220 mm

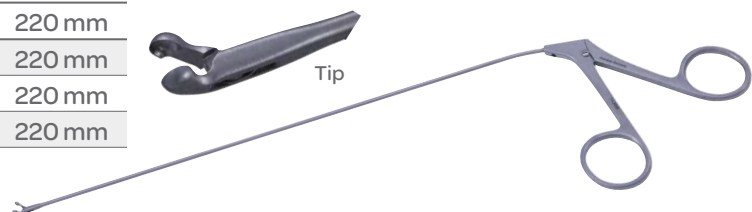

Kleinsasser Micro Laryngeal Cup Forceps

CODE	DESCRIPTION	CUPS	LENGTH
74-6019	Straight	1 mm	10¾ in 270 mm
74-6020	Straight	2 mm	10¾ in 270 mm
74-6024	Curved Left	1 mm	10¾ in 270 mm



Forceps (Micro Laryngeal Grasping)

Jako-Kleinsasser Micro Laryngeal Grasping Forceps

CODE	DESCRIPTION	LENGTH
74-5972	Straight	8⅝ in 220 mm
74-5971	Curved Right	8⅝ in 220 mm

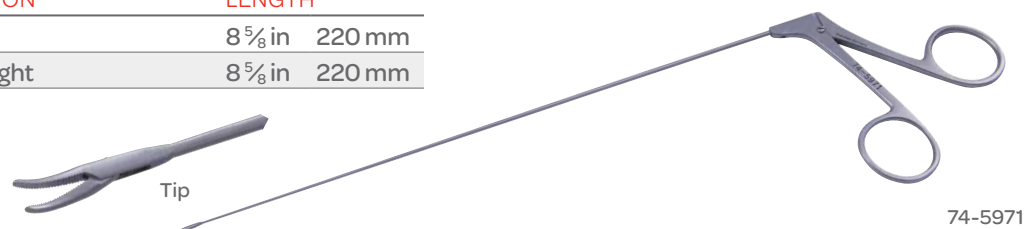

Forceps (Laryngeal)

Jako Micro Laryngeal Instruments Alligator Grasping Forceps

Serrated Jaws

CODE	DESCRIPTION	JAWS	LENGTH
74-5920	Straight	1.5x10 mm	9½ in 240 mm
74-5921	Curved Left	1.5x8.5 mm	9½ in 240 mm
74-5922	Curved Right	1.5x8.5 mm	9½ in 240 mm
74-5923	Curved Up	1.5x8.5 mm	9½ in 240 mm

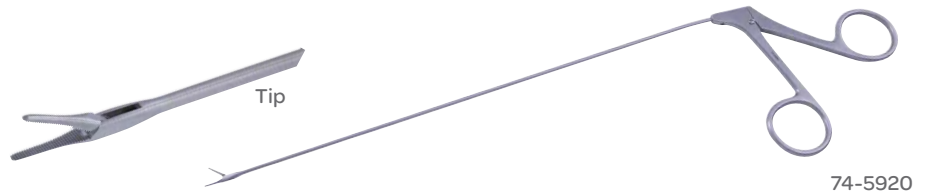

Forceps (Middle Ear)

House Miniature Forceps

3 mm, Finely Serrated

CODE	DESCRIPTION	LENGTH
61-0160	73 mm Shaft	5¼ in 135 mm



Ebonized House-Wullstein Miniature Forceps

3 mm, Finely Serrated

CODE	DESCRIPTION	LENGTH
61-0160E	75 mm Shaft	5¼ in 135 mm



Forceps (Middle Ear)

House Oval Cup Forceps

CODE	DESCRIPTION	CUPS	LENGTH
61-0152	Straight, 75 mm Shaft	0.6 x 1.0 mm Oval	5 ¼ in 135 mm
61-0154	Angled Left, 75 mm Shaft	0.6 x 1.0 mm Oval	5 ¼ in 135 mm
61-0155	Angled Right, 75 mm Shaft	0.6 x 1.0 mm Oval	5 ¼ in 135 mm
61-0142	Angled Right 15°, 0.9 mm	Oval	5 ¼ in 135 mm
61-0143	Angled Left 15°, 0.9 mm	Oval	5 ¼ in 135 mm
61-0155E	Ebonized		5 ¼ in 135 mm

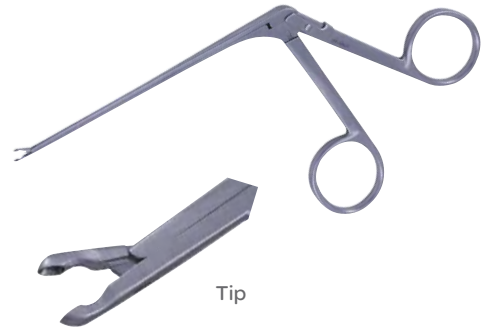

House Miniature Forceps

4.0 mm, Finely Serrated

CODE	DESCRIPTION	LENGTH
61-0147	73 mm Shaft	5 ¼ in 135 mm
61-0147E	75 mm Shaft, Ebonized	5 ¼ in 135 mm



61-0147

House Wullstein Miniature Ear Cup Forceps

Very Fine Oval Cup

CODE	DESCRIPTION	CUP SIZE	LENGTH
61-4122	Straight, 75 mm Shaft	0.6 x 1 mm	5 in 125 mm
61-0170	Angled Up, 72 mm Shaft	0.6 x 1 mm	5 in 125 mm
61-1290	Angled Down, 72 mm Shaft	0.6 x 1 mm	5 in 125 mm
61-1287	Angled Up 35°, 72 mm Shaft	0.6 x 1 mm	5 in 125 mm
61-1288	Angled Up 90°, 72 mm Shaft	0.6 x 1 mm	5 in 125 mm



61-0170

House Alligator Crimper Forceps

Serrated

CODE	DESCRIPTION	JAWS	LENGTH
61-0138	75 mm Shaft	8 mm Tapered to Dull Point	8 ⅝ in 220 mm



Forceps (Middle Ear)

House Alligator Forceps

Serrated

CODE	DESCRIPTION	SHAFT	JAWS	LENGTH
61-0146	Straight	74 mm	6 mm	5 ½ in 140 mm
61-0140	Right Side Opening	75 mm	6 mm	5 ¼ in 135 mm



61-0146

Hough CRURA Stapedectomy Forceps

3 mm Blade, Smooth 5 mm Jaws, Shaft 75 mm

CODE	DESCRIPTION	LENGTH
61-0130	Angled 45°, Left	9 ½ in 240 mm
61-0129	Angled 45°, Right	9 ½ in 240 mm
61-0126	Angled 45°, Right	9 ½ in 240 mm



61-0126

House Strut Forceps

75 mm Shaft

CODE	JAWS	LENGTH
61-0139	Smooth 6 mm	5 ¼ in 135 mm

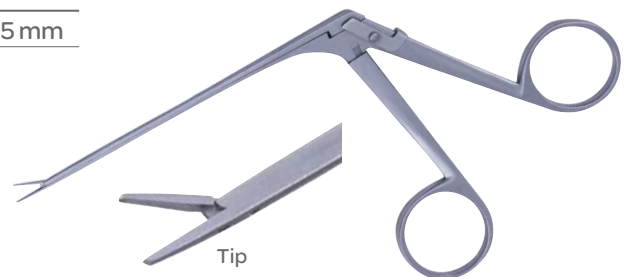

Tip

McGee Wire Crimper Forceps

Delicate 3 mm

CODE	SHAFT	JAWS	LENGTH
61-0124	72 mm	Angled Down	5 ¼ in 135 mm
61-0125	75 mm	Straight	5 ¼ in 135 mm



61-0124

Forceps (Nasal)

Access Blakesley Forceps

CODE	DESCRIPTION	DIAMETER	WORKING LENGTH
11-102	0°	4 mm	89 mm
11-142	45°	4 mm	89 mm
11-192	90°	4 mm	89 mm



Blakesley Nasal Forceps

CODE	DESCRIPTION	TIP SIZE
66-2551	Straight, Serrated	6 x 13 mm

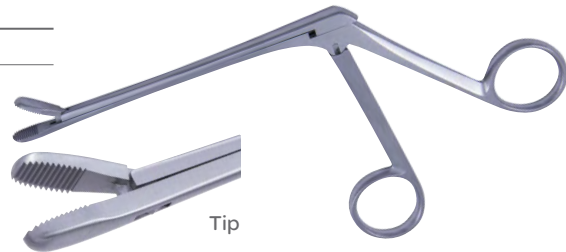

Noyes Nasal Dressing Forceps

Serrated Jaws, 110 mm Shaft

CODE	JAWS	LENGTH
66-2030	4 x 14 mm	6 ³ / ₄ in 171 mm



Takahashi Forceps

CODE	DESCRIPTION	JAWS	LENGTH
63-2026	Straight	2 x 10 mm	6 ³ / ₄ in 171 mm

Takahashi Nasal Forceps

4³/₈ in (110 mm) Shaft

CODE	DESCRIPTION	CUP SIZE	LENGTH
63-2019	Upturned 45°	2 x 8 mm	7 ¹ / ₄ in 185 mm
63-2020	Straight	2.5 x 8 mm	7 ¹ / ₄ in 185 mm
63-2020S	Straight with Suction	3 x 10 mm	7 ¹ / ₄ in 185 mm
63-2021	Straight	4 x 10 mm	7 ¹ / ₄ in 185 mm

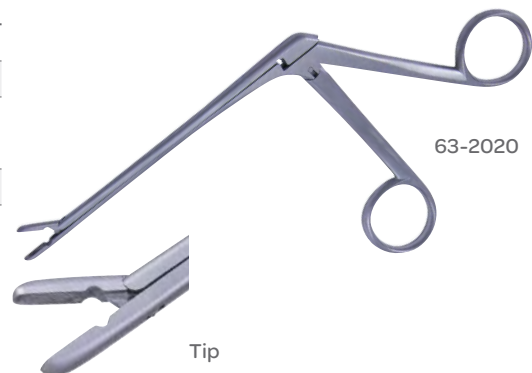

Forceps (Nasal)

Weil-Blakesley Nasal Forceps

Fenestrated Oval Cups, 4³/₈ in (110 mm) Shaft

CODE	SIZE	TIP	LENGTH
66-2810	#00	2.5 mm, Upturned 45°	7½ in 190 mm
66-2811	#0	3.5 mm, Upturned 45°	7½ in 190 mm
63-7634	#0	3.5 mm, Upturned 90°	7½ in 190 mm
66-2812	#1	4 mm, Upturned 45°	7½ in 190 mm
63-7635	#1	4 mm, Upturned 90°	7½ in 190 mm
66-2813	#2	5 mm, Upturned 45°	7½ in 190 mm

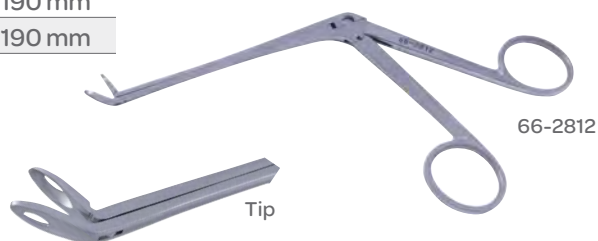

Weil-Blakesley Nasal Forceps

Upturned 45°, Fenestrated Oval Cups, 4³/₈ in (110 mm) Shaft, w/Suction

CODE	SIZE	TIP	LENGTH
66-2810S	#00	2.5 mm	7½ in 190 mm
66-2811S	#0	3.5 mm	7½ in 190 mm
66-2812S	#1	4 mm	7½ in 190 mm
66-2813S	#2	5 mm	7½ in 190 mm



Weil-Blakesley Nasal Forceps

Straight, Fenestrated Oval Cups, 4³/₈ in (110 mm) Shaft

CODE	DESCRIPTION	SIZE	TIP	LENGTH
63-2012		#00	2.5 mm	7½ in 190 mm
63-2009		#0	3.5 mm	7½ in 190 mm
63-2010		#1	4 mm	7½ in 190 mm
63-2011		#2	5 mm	7½ in 190 mm
63-2012S	With Suction	#00	2.5 mm	7½ in 190 mm
63-2009S	With Suction	#0	3.5 mm	7½ in 190 mm
63-2010S	With Suction	#1	4 mm	7½ in 190 mm
63-2011S	With Suction	#2	5 mm	7½ in 190 mm



Forceps (Nasal)

Weil-Blakesley Nasal Forceps

Fenestrated Oval Cups, 2.5 mm x 4.5 mm cups, 4 $\frac{3}{8}$ in (11 mm) shaft

CODE	DESCRIPTION	LENGTH
63-7423S	#00 Straight with Suction	7 $\frac{1}{2}$ in 190 mm
63-7424S	#00 Upturned 45° with Suction	7 $\frac{1}{2}$ in 190 mm
63-7425S	#00 Upturned 90° with Suction	7 $\frac{1}{2}$ in 190 mm
63-7423	#00 Straight	7 $\frac{1}{2}$ in 190 mm
63-7424	#00 Upturned 45°	7 $\frac{1}{2}$ in 190 mm
63-7424S	#00 Upturned 90°	7 $\frac{1}{2}$ in 190 mm



Weil-Blakesley Thru-Cutting Nasal Forceps

Bottom Jaw Serrated

CODE	DESCRIPTION	JAWS	SHAFT	LENGTH
63-6600	#00 Straight	2.5 mm	120 mm	7 $\frac{1}{4}$ in 185 mm
63-6602	#00 Upturned 45°	2.5 mm	120 mm	7 $\frac{1}{4}$ in 185 mm
63-6610	#0 Straight	3.5 mm	120 mm	7 $\frac{1}{4}$ in 185 mm
63-6618	#0 Jaws Angled Left	3.5 mm	120 mm	7 $\frac{1}{4}$ in 185 mm
63-6612	#0 Upturned 45°	3.5 mm	120 mm	7 $\frac{1}{4}$ in 185 mm
63-6611	#1 Straight	4 mm	120 mm	7 $\frac{1}{4}$ in 185 mm
63-6613	#1 Upturned 45°	4 mm	120 mm	7 $\frac{1}{4}$ in 185 mm

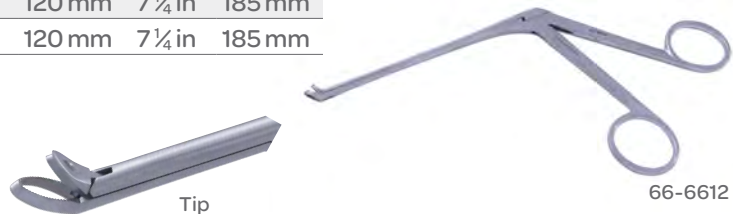

Forceps (Nasal Dressing)

Hartmann Nasal Dressing Forceps

CODE	DESCRIPTION	LENGTH
63-2017	Nasal Dressing Forceps	7 in 175 mm



Foreceps (Nasal Polyp)

Watson Williams Nasal Polyp Forceps

CODE	JAWS	SHAFT	LENGTH
63-2002	6 x 8 mm	110 mm	7 1/8 in 180 mm
63-2003	9 x 13 mm	110 mm	7 1/8 in 180 mm



Foreceps (Nasal Punch)

Gruenwald Nasal Punch Forceps

Jaws with No Cutting Edge

CODE	JAWS	SHAFT	LENGTH
66-3121	2.5 x 9 mm	110 mm	7 1/2 in 190 mm



Forceps (Oval Cup)

Ultra™ Oval Cup Forceps

Very Fine 4.0 mm Jaws with Oval Spoon Jaws, 0.9 x 0.2 mm

CODE	DESCRIPTION	LENGTH
61-0150	75 mm Shaft	5 1/4 in 135 mm
61-0150E	Ebonized	5 1/4 in 135 mm

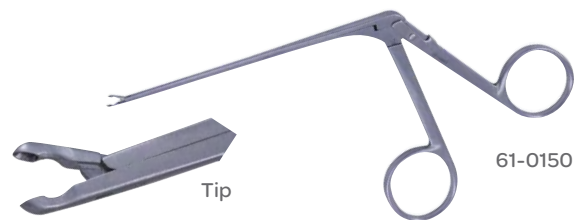

Forceps (Post Nasal)

Hildyard Post Nasal Forceps

CODE	DESCRIPTION	LENGTH
66-2519	Round Cup, 3.5 mm	6 3/4 in 170 mm



Forceps (Septum)

Asch Septum Straightening Forceps

CODE	DESCRIPTION	JAWS	LENGTH
67-6520	Angled on Flat	7 x 49 mm	8 ³ / ₄ in 220 mm



Bruening Septum Forceps

CODE	DESCRIPTION	LENGTH
66-2502	9 x 11 mm	7 ¹ / ₈ in 180 mm

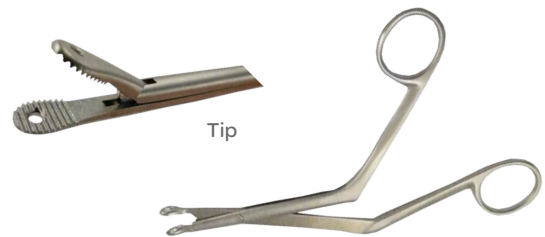

Jansen-Middleton Septum Forceps

Cutting Jaws

CODE	DESCRIPTION	LENGTH
66-2560	4 x 11 mm	6 ³ / ₄ in 170 mm

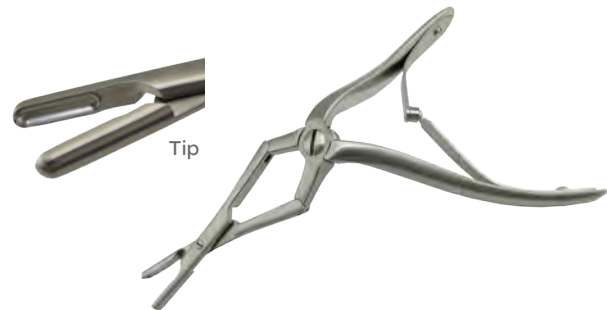

Jansen-Middleton Septum Forceps

Thru-Cutting Jaws

CODE	DESCRIPTION	SHAFT	LENGTH
66-2565	4 x 14 mm		7 ¹ / ₂ in 190 mm
66-2566	3 x 13 mm	Narrow	7 ¹ / ₂ in 190 mm



Walsham Septum Straightening Forceps

CODE	DESCRIPTION	LENGTH
67-6513	Bayonet Blades, Straight Jaws	9 in 230 mm



Forceps (Septum)

Septum Morselizing Forceps

CODE	DESCRIPTION	LENGTH
63-5007	Straight	7¾ in 195 mm
63-5009	Angled	7¾ in 195 mm

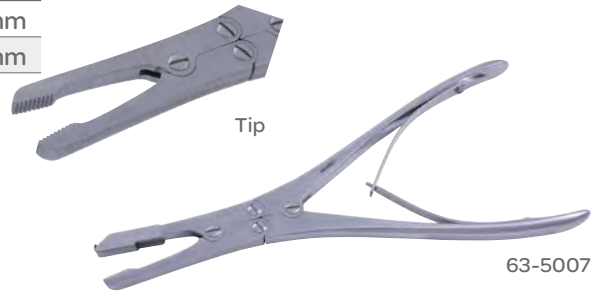

Forceps (Sinus)

Sinus Giraffe Forceps

Double-Action Cupped Forceps

CODE	DESCRIPTION	JAWS	LENGTH
63-5730	70° Horizontal	3 mm	4¾ in 120 mm
63-5731	110° Horizontal	3 mm	4¾ in 120 mm
63-5736	70° Vertical	3 mm	4¾ in 120 mm
63-5734	110° Vertical	3 mm	4¾ in 120 mm
63-5732	70° Horizontal	4 mm	4¾ in 120 mm
63-5733	110° Horizontal	4 mm	4¾ in 120 mm
63-5737	70° Vertical	4 mm	4¾ in 120 mm
63-5735	110° Vertical	4 mm	4¾ in 120 mm



Forceps (Sinus & Nasal)

Circular Cutting Antrum Punch Forceps

Allows Cutting 360° without Rotating the Instrument

CODE	DESCRIPTION	BITE	SHAFT
63-7453	Straight	3.5 mm	170 mm
63-7455	45° Upturned	3.5 mm	170 mm



Forceps (Sinus & Nasal)

Heuwer Antrum Forceps

Fenestrated and Stationary to 90°, Moveable to 120° Jaws, 100 mm Shaft

CODE	JAWS	LENGTH
63-7460	3 x 8 mm	4 in 100 mm



Forceps (Sponge)

Ferris Smith Sponge Forceps

Serrated Jaw

CODE	JAWS	LENGTH
66-2540	6 x 8 mm	7½ in 190 mm



Forceps (Tonsil)

Allis-Coakley Tonsil Forceps

One Open Ring Handle

CODE	DESCRIPTION	LENGTH
72-1002	Straight	7½ in 190 mm
72-1003	Slight Curve	7½ in 190 mm
72-1004	Strong Curve	7½ in 190 mm



72-1003

Forceps (Tonsil)

Colver Tonsil Seizing Forceps

CODE	DESCRIPTION	LENGTH
72-4019	Curved	7½ in 190 mm



St. Clair Adenoid Forceps

CODE	DESCRIPTION	LENGTH
71-5018	5 x 10 mm, Ring Jaw	7¼ in 185 mm



Tivnen Tonsil Forceps

One Open-Ring Handle

CODE	DESCRIPTION	LENGTH
72-1007	3 x 3 Prongs, Angled	8 in 200 mm



White Tonsil Forceps

One Open Ring Handle

CODE	DESCRIPTION	LENGTH
72-1005	Medium Curve	9½ in 241 mm

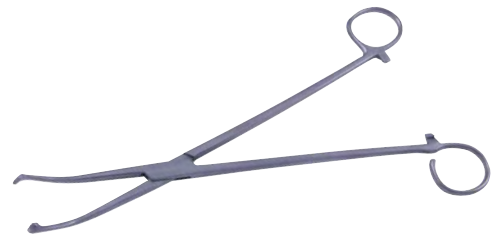

Forceps (Turbinate)

Stryucken Turbinate Forceps

With Sharp Thru-Cutting Edge, 110 mm Shaft

CODE	JAWS	LENGTH
66-3110	1 x 15 mm	6¾ in 171 mm



Handles (Knife)

Landolt Knife Handle

CODE	DESCRIPTION	LENGTH
01-2721		8¼ in 210 mm
01-2725		10 in 250 mm
01-2726	Replacement Collet	



Hooks (Double)

Cottle Double Hook

Sharp Prongs

CODE	DESCRIPTION	LENGTH
67-2003	3 mm Wide	6 in 150 mm

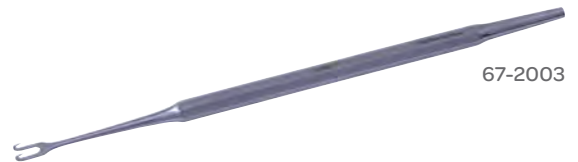

Cottle-Joseph Double Hook

Sharp Prongs

CODE	DESCRIPTION	LENGTH
63-0313	2 mm Wide	5½ in 140 mm



Freer Double Hook

CODE	DESCRIPTION	PRONGS	LENGTH
20-5202	3 mm Wide	Sharp	6 in 150 mm

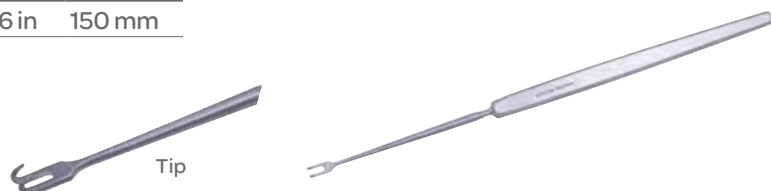

Hooks (Dura)

Adson Dura & Nerve Hook

CODE	DESCRIPTION	PRONGS	LENGTH
20-2722	3 mm Tip	Sharp	8 in 200 mm
20-2723	3 mm Tip	Blunt	8 in 200 mm



Hooks (Ear)

Day Ear Hook

CODE	DESCRIPTION	TIP	LENGTH
62-1650	Extra Small	1.5 mm	6 in 150 mm
62-1651	Small	2 mm	6 in 150 mm
62-1652	Large	2.5 mm	6 in 150 mm

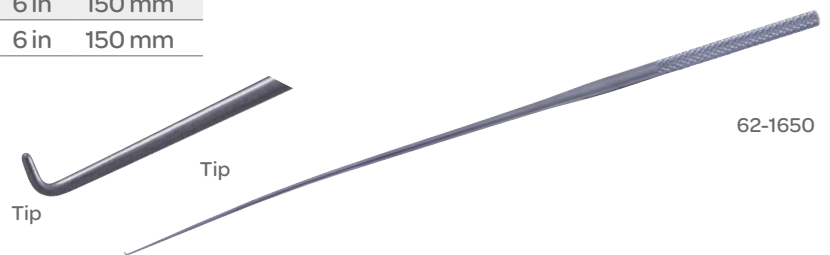

Lillie Ear Hook

Angled 90°

CODE	TIP	LENGTH
61-0024	1 mm Ball	7 in 175 mm



Hooks (Double Fixation)

Double Fixation Hook

CODE	DESCRIPTION	LENGTH
60-1298	1.5 mm Wide	5¼ in 135 mm
60-1299	2 mm Wide	5¼ in 135 mm

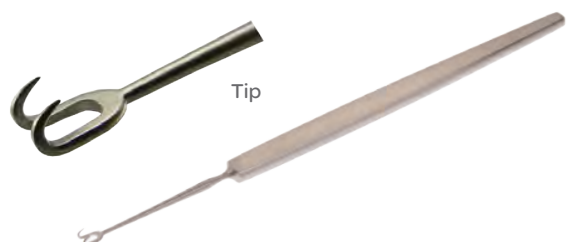

Hooks (Iris, Middle Ear)

Tyrell Iris Hook

CODE	DESCRIPTION
38-6525	Iris Hook

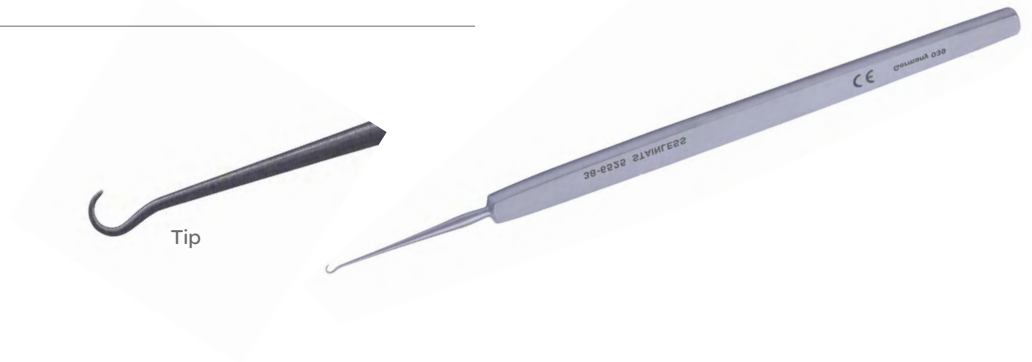

Shea Oblique Hook

CODE	DESCRIPTION	HOOK	LENGTH
62-0425	Angled 90°	Blunt 0.2mm	6 in 150 mm

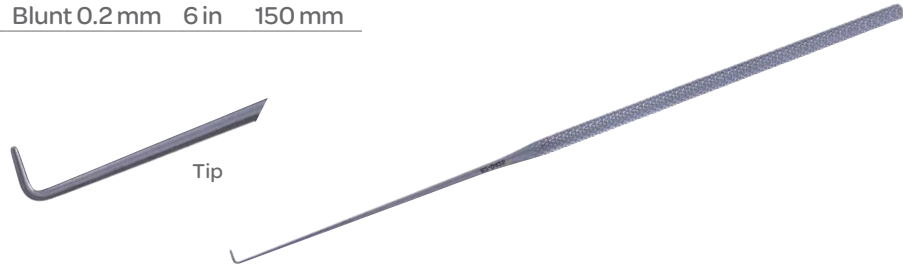

Schuknecht Posterior Foot Plate Hook

CODE	DESCRIPTION	TIP	LENGTH
61-0475	Angled Down Shaft	0.6 mm	6½ in 165 mm

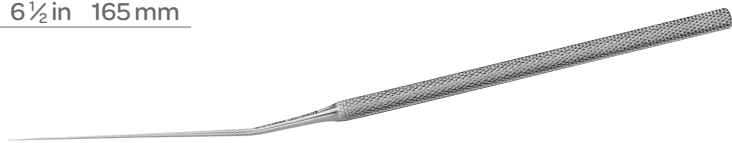

Schuknecht Anterior Foot Plate Hook

CODE	DESCRIPTION	TIP	LENGTH
61-0473	Angled Up Shaft	0.3 mm	6½ in 165 mm

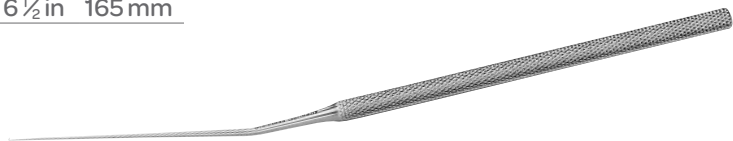

Hooks (Middle Ear)

Shea Foot Plate Hook

Very Fine 4.0 mm Jaws with 0.9 x 0.2 mm Oval Spoon

CODE	DESCRIPTION	TIP SIZE	LENGTH
62-0420	Angled 45°	1 mm	5¼ in 135 mm
62-0440	Angled 90°	1 mm	5¼ in 135 mm



Saunders-Paparella Stapes Hook

Malleable Shaft, Fine Point

CODE	DESCRIPTION	TIP SIZE	LENGTH
61-3770	Angled Shaft, 90° Angled Tip	0.33 mm	6½ in 165 mm

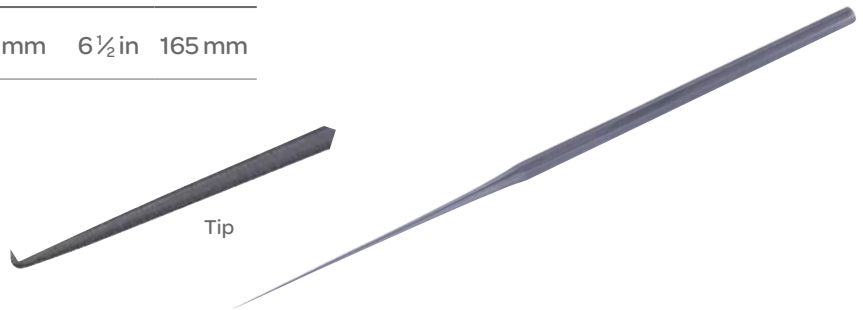

Schuknecht Stapes Hook

Angled Shaft

CODE	DESCRIPTION	TIP	LENGTH
61-0476	Angled 90° Up	1 mm	6¼ in 160 mm



Ebonized Schuknecht Hook

CODE	DESCRIPTION	TIP	LENGTH
61-0474E	Shaft Angled Down	0.3 mm	6¾ in 170 mm



Hooks (Middle Ear, Nerve, Single)

House Hook

CODE	DESCRIPTION
61-0386	Angled Right 90°

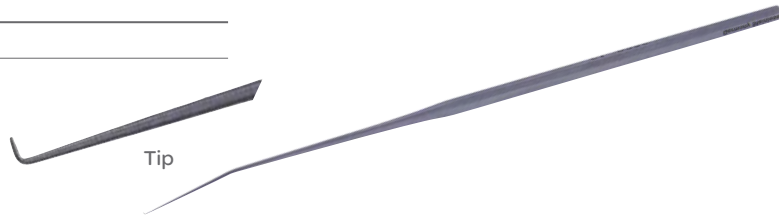

Single Hook

CODE	DESCRIPTION	LENGTH
20-5012	2 mm Sharp	5 3/4 in 146 mm



Hooks (Nerves)

Cushing Nerve Hook

CODE	DESCRIPTION	LENGTH
20-2231	4 mm Ball Tip	7 1/2 in 190 mm
20-2232	6 mm Ball Tip	7 1/2 in 190 mm



Hooks (Retractor)

Tracheal Hook

CODE	PRONG	LENGTH
20-6403	3 Sharp Prongs	6 1/4 in 160 mm



Cottle Single Hook

CODE	DESCRIPTION	DETAILS	LENGTH
63-0302	Small	Shallow Curved	5 1/4 in 135 mm
63-0303	Small	Deep Curve	5 1/4 in 135 mm
63-0304	Large	Deep Curve	5 1/4 in 135 mm

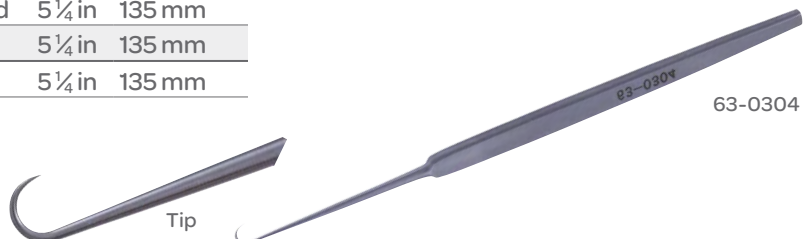

Hooks (Skin)

Barsky Skin Hook

CODE	DESCRIPTION	LENGTH
20-3501	Single Prong	6 in 150 mm



Converse Skin Hook

CODE	DESCRIPTION	LENGTH
63-0306	Small	7 in 175 mm
63-0307	Large, Deep Curve	7 in 175 mm

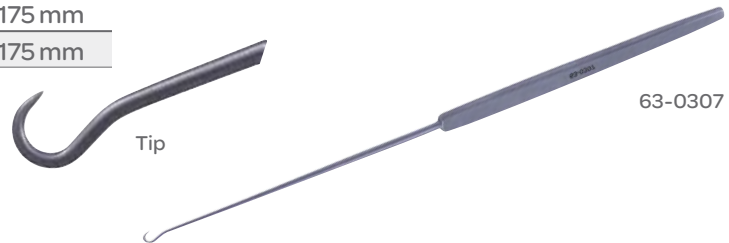

Humby Swivel Skin Hook

CODE	DESCRIPTION	TIP	LENGTH
20-3532	Sharp	0.5 mm	4 1/2 in 115 mm



Joseph Skin Hook

CODE	DESCRIPTION	HOOK WIDTH	LENGTH
20-5001	Single Prong	4 mm	6 1/4 in 160 mm
20-5005	Double Prong	5 mm	6 1/4 in 160 mm
20-5007	Double Prong	7 mm	6 1/4 in 160 mm
20-5010	Double Prong	10 mm	6 1/4 in 160 mm



Kilner Skin Hook

CODE	DESCRIPTION	LENGTH
20-5109	Sharp	6 in 150 mm



Hooks (Tenaculum)

Cottle Tenaculum Hook

CODE	DESCRIPTION	LENGTH
20-4016	Angled	6¼ in 160 mm



Hooks (Thimble)

Millard Thimble Hook

CODE	DESCRIPTION	LENGTH
67-2023	Single Prong	3¼ in 82 mm



Hooks (Tracheal)

News Tracheal Hook

CODE	DESCRIPTION	LENGTH
20-4015	Single Prong	6 in 150 mm



Tracheal Hook

CODE	DESCRIPTION	LENGTH
20-6402	Double-Sharp Prongs	6¼ in 160 mm



Hooks (Tracheal)

Tracheal Hook

CODE	DESCRIPTION	LENGTH
20-6502	2 Blunt Prongs	6 ¼ in 160 mm



Inserters (Middle Ear)

Shea Prosthesis Placement Instrument

CODE	DESCRIPTION	TIP SIZE	LENGTH
62-0470	Angled 45°	0.5 mm	6 ¼ in 160 mm



Instrument Covers (Forceps Protectors)

Forceps Protectors

CODE	DESCRIPTION
62-4990	10 mm Wide, Protection Tube for Ear Forceps, Autoclavable

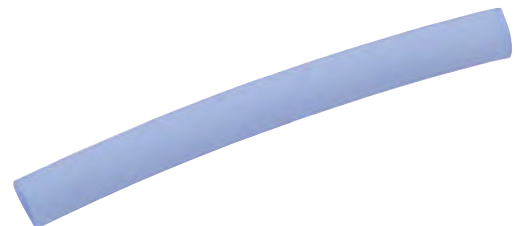

Knives (Button End)

Converse Button End Knife

CODE	LENGTH
67-1035	6 in 150 mm



Joseph Button End Knife

CODE	DESCRIPTION	LENGTH
67-1030	Straight	6 in 150 mm
67-1060	Angled	6 in 150 mm



Knives (Canal)

Jordon Canal Knife

Tapered, 2 x 3 mm Blade

CODE	DESCRIPTION	LENGTH
61-0415	Angled 45°	6 ½ in 165 mm

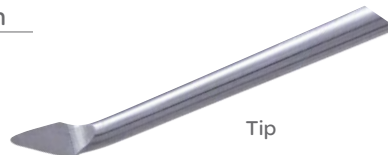

Knives (Cartilage)

Maltz Cartilage Knife

Blunt Tip, Angled

CODE	DESCRIPTION	LENGTH
67-1065	With Blade Guard	6 3/4 in 170 mm



Knives (Ear)

Ear Knife Blade & Handle

CODE	DESCRIPTION
61-0258	Replacement Baldes (6 per package)
61-0256	Chuck Handle



Knives (Micro-Laryngeal)

Jako Micro Laryngeal Knife

CODE	DESCRIPTION	LENGTH
74-4510	Sickle Blade	11 5/8 in 295 mm

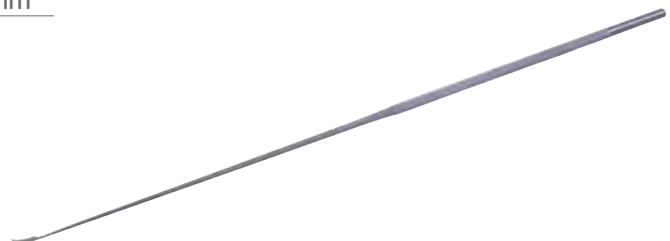

Knives (Middle Ear)

McCabe Canal Knife

CODE	TIP	BLADE DIAMETER	LENGTH
62-0481	Sharp	2 mm	6 ³ / ₄ in 170 mm



Rosen Cartilage Knife

CODE	DESCRIPTION	LENGTH
67-1080	Double-Ended Blades at 45° and 90°	7 ³ / ₄ in 195 mm



Guilford-Wright Elevator Knife

CODE	TIP WIDTH	LENGTH
61-0331	2 mm	5 ¹ / ₂ in 140 mm

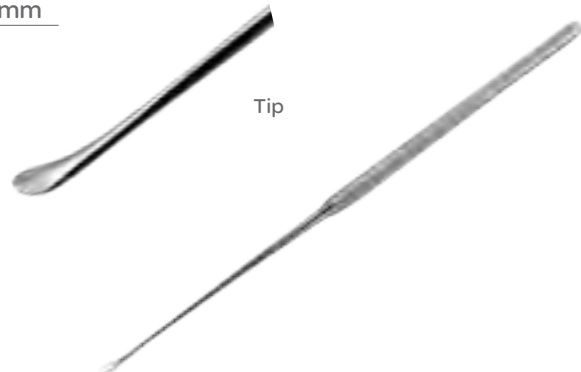

Tabb Flap Knife

Double-Ended

CODE	BLADES	LENGTH
61-0270	Angled 25° and 45°	6 ¹ / ₄ in 160 mm
61-0271	Angled 90° and 120°	6 ¹ / ₂ in 165 mm



Knives (Middle Ear)

House Incudostapedial Joint Knife

CODE	ANGLE	BLADE	LENGTH
61-0396	20°	0.5 x 1.5 mm	6½ in 165 mm
61-0378	60°	0.75 mm	6¾ in 170 mm

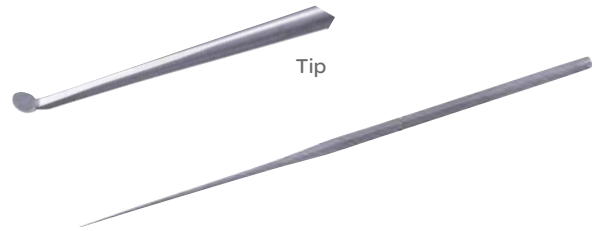

Paparella Incudostapedial Joint Knife

CODE	ANGLE	BLADE	LENGTH
61-0435	20°	0.5 x 1.5 mm	6½ in 165 mm

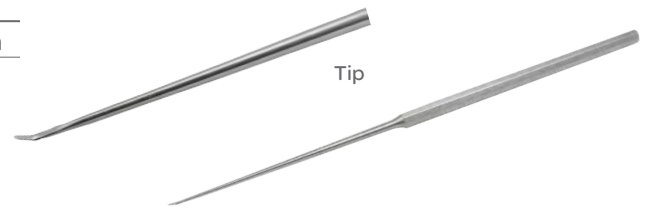

House Lancet Knife

#2 Knife

CODE	ANGLE	BLADE	LENGTH
61-0377	45°	2 x 3 mm	6½ in 165 mm



Hough Drum Scraper

Shaft Angled 15°

CODE	POINT/TIP	LENGTH
61-0352	0.5 mm Point Angled 45° on 2.5 mm Tip Angled 60°	6 in 150 mm



Tabb Myringoplasty Knife

Curved

CODE	BLADE	LENGTH
61-0269	Curved, 8 mm	6½ in 165 mm

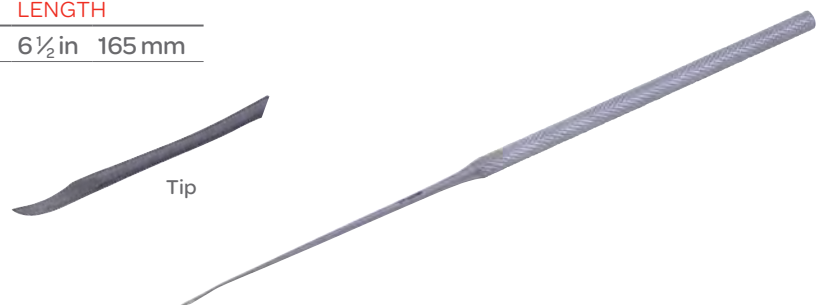

Knives (Middle Ear)

House Myringotomy Knife

CODE	BLADE	LENGTH
61-0397	3.5 mm	6½ in 165 mm



Tabb Pick Knife

CODE	BLADE	LENGTH
61-0273	3 mm	6¼ in 160 mm



Schuknecht Roller Knife

CODE	BLADE	SHAFT	LENGTH
61-0470	3 mm	Curved	7½ in 190 mm
61-0471	3 mm	90°	7½ in 190 mm

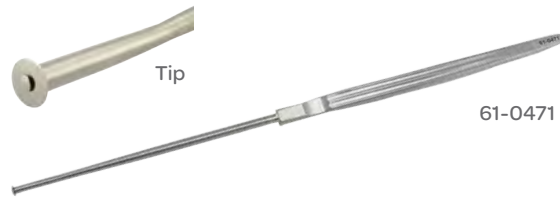

House Tympanoplasty Knife

CODE	DESCRIPTION	BLADE	LENGTH
61-0395	Curved	7 mm	6½ in 165 mm



Knives (Middle Ear, Myringotomy, Nasal)

Hough "Whirly Bird" Knife

Strong Curve, 1 x 5 mm Blade

CODE	DESCRIPTION	LENGTH
61-0344	#1 Angled Right	6 in 150 mm
61-0345	#2 Angled Left	6 in 150 mm



Myringotomy Knife

CODE	DESCRIPTION	LENGTH
61-0266	Straight	5¼ in 135 mm



Knives (Middle Ear, Myringotomy, Nasal)

Cottle Nasal Knife

CODE	DESCRIPTION	BLADE	LENGTH
67-1020	Straight	4 mm	5¼ in 135 mm
67-1033	Straight	Round	6 in 150 mm

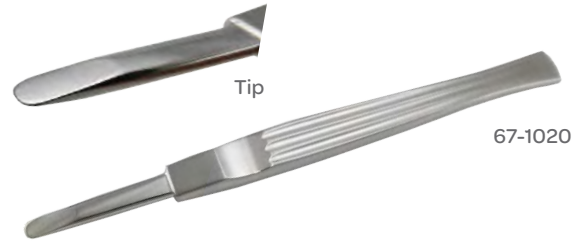

Joseph Nasal Knife

Double Edge Blade

CODE	DESCRIPTION	BLADE	LENGTH
63-0813	Straight	4 x 18 mm	6 in 150 mm
63-0812	Curved	4 x 22 mm	6 in 150 mm
63-0814	Curved	4 x 22 mm	6 in 150 mm



Knives (Middle Ear)

Sickle Knife

Middle Ear

CODE	TIP	ANGLE	LENGTH
61-0594	Sharp 10 mm	30° Left	7½ in 190 mm
61-0595	Sharp 10 mm	30° Right	7½ in 190 mm



House Sickle Knife

CODE	DESCRIPTION	BLADE	LENGTH
61-0379	"Number One Knife"	0.75 mm, Curved	6½ in 165 mm



Paparella Sickle Knife

CODE	DESCRIPTION	BLADE	LENGTH
61-3789	Straight	5.5 mm	6½ in 165 mm



Schuknecht Sickle Knife

CODE	DESCRIPTION	SHAFT	LENGTH
61-0469	7 mm	Angled	6¼ in 160 mm



Knives (Septum)

Freer Septum Knife

CODE	DESCRIPTION	TIP SIZE	LENGTH
66-5210	"D" Model	5 x 8 mm	6 ¼ in 160 mm
66-5208	Angled	3 mm Angled	7 in 175 mm
66-5201	"E" Model	-	7 ¼ in 185 mm



66-5208

Knives (Sinus & Nasal)

Sickle Knife

Curved Blade

CODE	TIP	LENGTH
63-7580	10 mm Sharp	7 ½ in 190 mm
63-7582	10 mm Blunt	7 ½ in 190 mm

Tip
63-7580

Ballenger Swivel Knife

CODE	DESCRIPTION	BLADE	LENGTH
66-5003	Straight	3 mm	7 ½ in 190 mm
66-5004	Straight	3 mm	7 ½ in 190 mm
66-5005	Straight	3 mm	7 ½ in 190 mm
66-5013	Bayonet	3 mm	8 in 200 mm
66-5014	Bayonet	4 mm	8 in 200 mm
66-5015	Bayonet	5 mm	8 in 200 mm



66-5015

Knives (Tonsil)

Canfield Tonsil Knife

CODE	BLADE	LENGTH
72-2030	9 mm Curved	8 ¼ in 210 mm



Knives (Tonsil)

Fisher Tonsil Knife

CODE	DESCRIPTION	LENGTH
72-2540	Slightly Curved Blade	7½ in 190 mm



Laryngoscope Holders

Lewy Laryngoscope Holder

CODE	DESCRIPTION
74-3520	Laryngoscope Holder



Loops (Ear)

Billeau Ear Loop

CODE	SIZE	LENGTH
62-1401	Small	6½ in 165 mm
62-1402	Medium	6½ in 165 mm
62-1403	Large	6½ in 165 mm



Mallets (Sinus & Nasal)

Cottle Mallet

One Flat Face and One Round Face

CODE	DESCRIPTION	LENGTH
67-4020	10 oz, 1¼ in (31 mm) Diameter Head	7½ in 190 mm



Mirrors (Laryngeal)

Laryngeal Mirror

Stationary Octagonal Handle

CODE	DESCRIPTION	SIZE	LENGTH
73-4808	#000	8 mm	6 ³ / ₄ in 171 mm
73-4810	#00	10 mm	6 ³ / ₄ in 171 mm
73-4812	#0	11 mm	6 ³ / ₄ in 171 mm
73-4814	#1	14 mm	6 ³ / ₄ in 171 mm
73-4816	#2	16 mm	6 ³ / ₄ in 171 mm
73-4818	#3	18 mm	6 ³ / ₄ in 171 mm
73-4820	#4	20 mm	6 ³ / ₄ in 171 mm
73-4822	#5	22 mm	6 ³ / ₄ in 171 mm
73-4824	#6	24 mm	6 ³ / ₄ in 171 mm
73-4826	#7	26 mm	6 ³ / ₄ in 171 mm
73-4828	#8	28 mm	6 ³ / ₄ in 171 mm

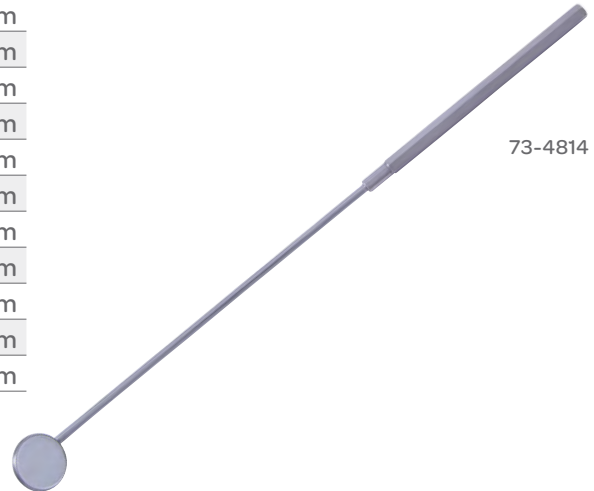

Mirrors (Middle Ear)

House Middle Ear Mirror

Straight Shaft

CODE	ANGLE	MIRROR	LENGTH
61-0390	45°	2 mm	6 ¹ / ₂ in 165 mm



Mobilizers (Middle Ear)

Derlacki Mobilizer

CODE	TIP	LENGTH
61-0516	Angled, Serrated Round End	6 ¹ / ₄ in 158 mm



Hough-Derlacki Mobilizer

CODE	TIP	LENGTH
61-0343	Curved, 4 Pronged, 2 mm Diameter	6 ¹ / ₄ in 160 mm



Mouth Gags (Tonsil & Laryngeal)

Crowe-Davis Mouth Gag Blades

CODE	DESCRIPTION	SIZE
45-5111	#1	18 x 23 mm
45-5112	#2	20 x 62 mm
45-5113	#3	25 x 75 mm
45-5114	#4	25 x 95 mm
45-5115	#5	25 x 106 mm



45-5111

Crowe-Davis Mouth Gag

CODE	DESCRIPTION	BITE
45-5122	Frame Only, Left	Double
45-5121	Frame Only, Right	Double
45-5122 x	Set of 2	Silicon Replacement Pads for Mouth Gag Frames 45-5122 and 45-5121
45-5126	Child Right	



45-5122

Mclvor Mouth Gag & Mclvor Tongue Blade

CODE	DESCRIPTION	SIZE
45-5300	Complete Set, Includes 1 of each of the items listed below.	
45-5320	Mouth Gag	Frame Only
45-5311	Tongue Blade #1	22 X 69 mm
45-5312	Tongue Blade #2	24 X 90 mm
45-5313	Tongue Blade #3	25 X 100 mm



45-5320



45-5313

Ring Blade

CODE	DESCRIPTION	SIZE
45-2140	Left #2	2 ¼ x 7/8 in 60 x 22 mm
45-2141	Left #3	3 x 1 1/8 in 76 x 28 mm
45-2143	Left #5	3 3/4 x 1 1/2 in 95 x 36 mm
45-2142	Left #4	3 1/2 x 1 1/4 in 90 x 32 mm
45-2144	Right #2	2 ¼ x 7/8 in 60 x 22 mm
45-2145	Right #3	3 x 1 1/8 in 76 x 28 mm
45-2146	Right #4	3 1/2 x 1 1/4 in 95 x 36 mm
45-2147	Right #5	3 3/4 x 1 1/2 in 90 x 32 mm



45-2140

Mouth Gags (Tonsil & Laryngeal)

Russel-Davis Tongue Blade

CODE	BLADE SIZE
45-5331	33 x 75 mm
45-5332	38 x 85 mm
45-5333	40 x 92 mm



45-5331

Dingman Mouth Gag

CODE	DESCRIPTION
72-0800	Complete Set includes Frame, 2 Lateral Cheek Retractors and the 3 Grooved Blades listed below.
72-0801	Frame Only
72-0811	Small, Blades with Groove 25 x 55 mm
72-0812	Medium, Blades with Groove 27 x 60 mm
72-0813	Large, Blades with Groove 30 x 70 mm



72-0800

Jennings Mouth Gag

Standard Pattern

CODE	DESCRIPTION	LENGTH
72-0709	Extra Small	3 ³ / ₈ in 90 mm
72-0711	Small	4 ³ / ₈ in 112 mm
72-0713	Medium	5 ¹ / ₈ in 130 mm
72-0715	Large	6 in 150 mm

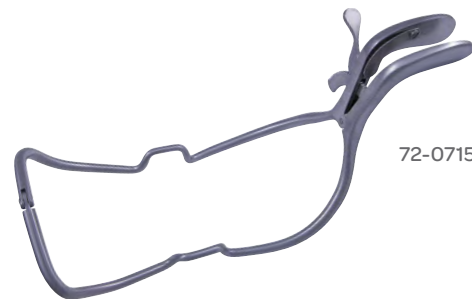

72-0715

Mouth Gags (Tonsil & Laryngeal)

Sluder Jansen/Schink Mouth Gag

CODE	DESCRIPTION	LENGTH
72-0515	Adult	4 ¹ / ₄ in 108 mm



Mouth Gags (Tonsil & Laryngeal)

Denhardt Mouth Gag

Self-Retaining

CODE	DESCRIPTION
72-0560	Serrated, No inserts needed (Silicon pads not used with this item)
72-0561	Frame for use with Silicon Pads 72-0560x
72-0560x	Silicon Inserts for use with 72-0561



72-0560

McKesson Mouth Prop

Sold in pairs, Black

CODE	DESCRIPTION
62-1211	Infant
68-1212	Child
68-1214	Adult



68-1214

Needles (Middle Ear)

Shambaugh-Derlacki Needle

CODE	DESCRIPTION	LENGTH
61-0408	Straight Tip with Angled Shaft, Fine	6 ¼ in 160 mm
61-0409	Straight Tip with Angled Shaft, Super Fine	6 ¼ in 160 mm



61-0408

McGee Perforating Needle

CODE	DESCRIPTION	LENGTH
61-0431	Straight Point on Angled Shaft	6 ½ in 165 mm



Needles (Middle Ear)

House-Rosen Type Needle

Curved

CODE	DESCRIPTION	TIP SIZE	LENGTH
61-0361	Justify left	3 mm	6½ in 165 mm
61-0366	Slightly Dulled Point	4 mm	6½ in 165 mm



61-0361

Schuknecht Stapes Needle

CODE	DESCRIPTION	LENGTH
61-0477	Angled Shaft, Straight Tip	6¼ in 160 mm



Austin Needle

CODE	DESCRIPTION	TIP SIZE	LENGTH
61-0305	Slightly Curved	10 mm	6¼ in 160 mm

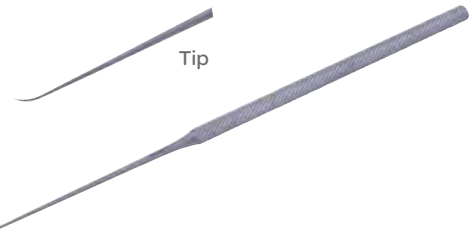

Tip

House Needle

CODE	DESCRIPTION	TIP SIZE	LENGTH
61-0359	Curved, Sharp Point	4 mm	6½ in 165 mm

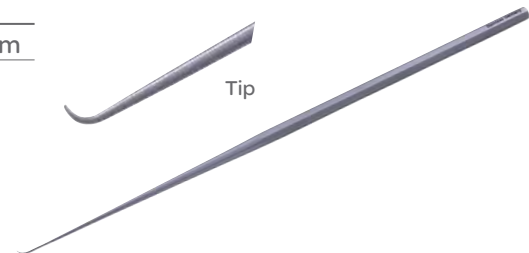

Tip

Saunders-Paparella Needle

Straight, Malleable Shaft, Fine Point

CODE	DESCRIPTION	LENGTH
61-3750	#5, Fine	6½ in 165 mm
61-3752	#6, Heavy	6½ in 165 mm



61-3750

Tip

Needles (Septum)

Septum Needle

CODE	DESCRIPTION
63-7591	90° Tip, Straight Shaft, 22 Gauge



Needles (Tonsil)

Tonsil Needle

23 Gauge

CODE	DESCRIPTION	NEEDLE EXTENSION
72-9514	45° Angle	13 mm
72-9510	Straight	13 mm



Nippers (Middle Ear)

House-Dieters Malleus Nipper

75 mm Shaft

CODE	DESCRIPTION	LENGTH
61-0158	1.5 mm Jaws	5 in 125 mm
61-0157	2 mm Jaws	5 in 125 mm



Nippers (Malleus)

Malleus Nipper

Delicate, Non-Serrated

CODE	DESCRIPTION	LENGTH
61-0700	7 mm Jaws	4 ½ in 115 mm



Sponges

Secto® Tonsil Sponges

Sterile Pack, 5 Per Card/Pouch, 25 Pouches Per Dispenser, 2 Dispensers Per Case

CODE	DESCRIPTION	SIZE
81-1010	X-Ray Detectable	5/8 in 16 mm
81-1011	X-Ray Detectable	1 in 25 mm
81-1012	X-Ray Detectable	4 1/2 in 32 mm

Note: Cord Length on all sizes is 10 in (254 mm)



81-1010

Osteotomes

Anderson-Neivert Osteotome

CODE	DESCRIPTION	WIDTH	LENGTH
63-0120	Curved Left	4 mm	8 1/4 in 210 mm
63-0119	Curved Right	4 mm	8 1/4 in 210 mm



63-0120

Converse Osteotome

CODE	DESCRIPTION	LENGTH
67-3102	2 mm	7 in 175 mm
67-3104	4 mm	7 in 175 mm
67-3106	6 mm	7 in 175 mm
67-3108	8 mm	7 in 175 mm
67-3110	10 mm	7 in 175 mm
67-3112	12 mm	7 in 175 mm



67-3102

Cottle Osteotome

Very Delicate, Round Corners

CODE	DESCRIPTION	LENGTH
63-0103	4 mm Wide	7 in 175 mm
63-0104	6 mm Wide	7 in 175 mm
63-0105	9 mm Wide	7 in 175 mm
63-0106	12 mm Wide	7 in 175 mm

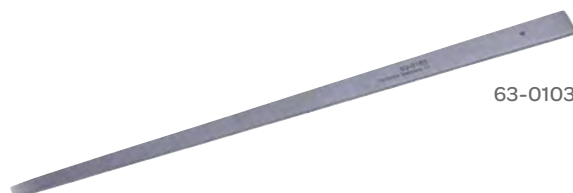

63-0103

Osteotomes

Neivert Osteotome

CODE	DESCRIPTION	GENERATOR PLUG	LENGTH
63-0121	Straight	With 4 mm Single Guarded Edge	8 in 200 mm

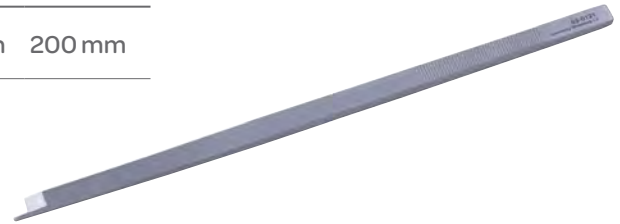

Osteotome

CODE	TIP WIDTH	LENGTH
63-0092	2 mm	6 ¼ in 160 mm
63-0093	3 mm	6 ¼ in 160 mm
63-0094	4 mm	6 ¼ in 160 mm
63-0095	5 mm	6 ¼ in 160 mm
63-0096	6 mm	6 ¼ in 160 mm
63-0097	7 mm	6 ¼ in 160 mm
63-0098	8 mm	6 ¼ in 160 mm
63-0099	9 mm	6 ¼ in 160 mm
63-0100	10 mm	6 ¼ in 160 mm
63-0101	11 mm	6 ¼ in 160 mm
63-0102	12 mm	6 ¼ in 160 mm



63-0092

Ristow Osteotome

CODE	DESCRIPTION	LENGTH
63-0122	Curved Right	8 in 200 mm



Rubin Osteotome

Rounded Corners with Finger Guard

CODE	DESCRIPTION	LENGTH
63-0107	10 mm Width, With 8 mm Cutting Edge	6 ½ in 165 mm
63-0108	14 mm Width, With 12 mm Cutting Edge	6 ½ in 165 mm
63-0109	16 mm Width, With 14 mm Cutting Edge	6 ½ in 165 mm



63-0108

Osteotomes

Silver Osteotome

5.0 mm Wide Angled Blade with Single Guarded Edge

CODE	DESCRIPTION	LENGTH	
67-3810	Straight	7¼ in	185 mm
67-3811	Right	7¼ in	185 mm
67-3812	Left	7¼ in	185 mm



Tessier Osteotome

CODE	DESCRIPTION	WIDTH	LENGTH	
63-0151	Straight	3.5 mm	6¼ in	160 mm



Osteotomes (Guarded)

Cinelli Double Guarded Osteotome

CODE	TIP WIDTH	LENGTH	
63-3710	10 mm	6 in	150 mm
63-3712	12 mm	6 in	150 mm
63-3714	14 mm	6 in	150 mm
63-3716	16 mm	6 in	150 mm



Converse Single Guarded Osteotome

CODE	DESCRIPTION	WIDTH	EDGE	LENGTH	
63-0117	Straight	6 mm		7½ in	190 mm
63-0116	Curved Left	6 mm		7½ in	190 mm
63-0115	Curved Right	6 mm	4.5 mm	7½ in	190 mm



Cottle Guarded Osteotome

CODE	DESCRIPTION	WIDTH	LENGTH	
63-0118	Straight	6 mm	7½ in	190 mm



Osteotomes (Guarded)

Fomon Guarded Osteotome

CODE	TIP WIDTH	LENGTH
63-0112	7 mm	6 ½ in 165 mm



Picks (Middle Ear)

House-Barbara Pick

CODE	DESCRIPTION	LENGTH
61-0365	Straight Tip, Malleable Shaft	6 ½ in 165 mm



Shea Pick

CODE	DESCRIPTION	LENGTH
61-0483	Blunt	6 ½ in 160 mm



House-Crabtree Dissector Pick "Jimmy"

Flat Tip, Angled 90°

CODE	DESCRIPTION	LENGTH
61-0392	Small 0.8 x 1.5 mm	6 ½ in 165 mm
61-0391	Large 0.5 x 2.5 mm	6 ½ in 165 mm



Picks (Middle Ear)

Hough Foot Plate Pick

Slightly Curved Tip

CODE	DESCRIPTION	LENGTH
61-0336	Fine Pattern	6 in 150 mm
61-0335	Heavy Pattern	6 in 150 mm



Hough "Hoe" Pick

0.5 mm Tip, Angled Shaft

CODE	DESCRIPTION	LENGTH
61-0351	Tip Angled 45°	6 in 150 mm
61-0340	Tip Angled 90°	6 in 150 mm



House Obtuse Pick

CODE	DESCRIPTION	LENGTH
61-0371	0.33 mm Tip, Angled 30°	6½ in 165 mm

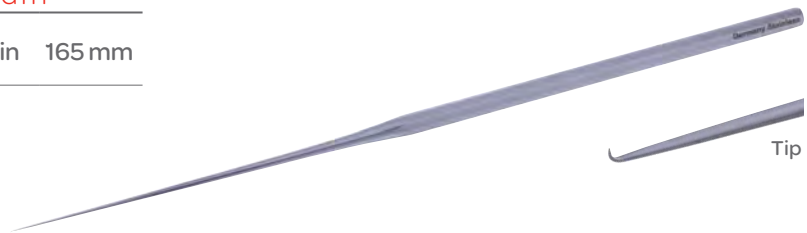

House Oval Window Pick

CODE	DESCRIPTION	LENGTH
61-0373	0.33 mm Tip, Medium Shaft, Tip Angled 90°	6½ in 165 mm
61-0383	0.33 mm Tip, Angled 30° on Straight Malleable Shaft	6½ in 165 mm
61-0384	0.66 mm Long Tip, Angled 30° on Straight Malleable Shaft	6½ in 165 mm

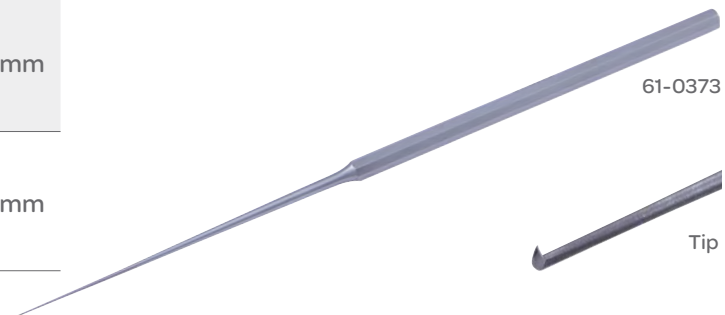

Picks (Middle Ear)

Hough Stapedectomy Pick

CODE	DESCRIPTION	LENGTH
61-0338	0.33 mm tip, Angled Shaft 90°	6 in 150 mm



House Strut Pick

Malleable Medium Shaft

CODE	DESCRIPTION	TIP	LENGTH
61-0374	Angled 90°	0.5 mm	6½ in 165 mm
61-0375	Angled 90°	0.66 mm	6½ in 165 mm



House Window Pick

Fine shaft

CODE	DESCRIPTION	LENGTH
61-0372	0.33 mm, Angled 90°	6½ in 165 mm

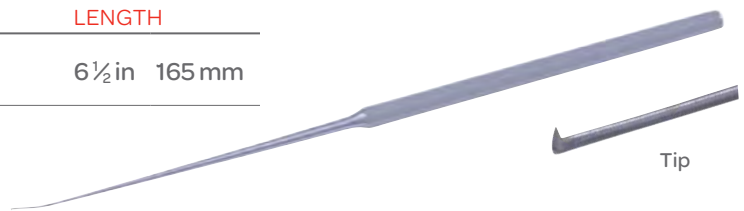

Austin Pick

CODE	ANGLE	GENERATOR PLUG	LENGTH
61-0317	25°	1 mm Tip	6¼ in 160 mm
61-0306	45°	1 mm Wide Tip	6¼ in 160 mm
61-0308	90°	1 mm Wide Tip	6¼ in 160 mm
61-0307	90°	3 mm Wide Tip	6¼ in 160 mm

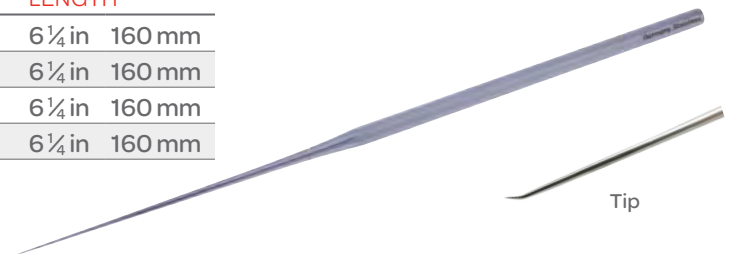

Picks (Middle Ear)

McGee Pick

CODE	DESCRIPTION	POINT	LENGTH
61-0425	Anterior Angled 90° Up	0.2 mm	6½ in 165 mm
61-0426	Posterior Angled 90° Down	0.2 mm	6½ in 165 mm



61-0425

Paparella Pick

CODE	DESCRIPTION	BLADE	LENGTH
61-3812	Angled Left	1 x 4 mm	6½ in 165 mm
61-3810	Angled Right	1 x 4 mm	6½ in 165 mm



61-3812

Rosen Pick

CODE	DESCRIPTION	LENGTH
61-0445	Curved Tip	6½ in 165 mm
61-0446	Angled Tip	6½ in 165 mm



61-0445

Tip

Hough Pick

Straight Malleable Heavy Shaft

CODE	DESCRIPTION	LENGTH
61-0349	Straight Tip	6 in 150 mm
61-0387	1 mm Tip	6½ in 165 mm
61-0388	1.5 mm Tip	6½ in 165 mm
61-0389	3 mm Tip	6½ in 165 mm



61-0349

Picks (Middle Ear)

Kos Pick

CODE	DESCRIPTION	LENGTH
61-7723	Bayonet Shaft, 0.33 mm Point 90°	7 in 180 mm



Presses

Sheehy Fascia Press

CODE	GENERATOR PLUG	LENGTH
61-0517	23 x 31 mm Plate	7½ in 190 mm



House Gelfoam Press

CODE	DESCRIPTION	LENGTH
61-0518	16 x 12 mm Plate	7½ in 190 mm
61-0519	16 x 12 mm plate	5 in 130 mm



61-0519

Probes (Laryngeal)



Jako Laryngeal Probe

CODE	DESCRIPTION	WORKING LENGTH	LENGTH
74-4520	Straight	8 ⁵ / ₈ in 220 mm	11 ⁵ / ₈ in 295 mm
74-4521	Angled	8 ⁵ / ₈ in 220 mm	11 ⁵ / ₈ in 295 mm

Probes (Periodontal)



Periodontal Probe

CODE	DESCRIPTION	LENGTH
69-6218	Dental Probe	6 in 152 mm

Probes (Sinus)

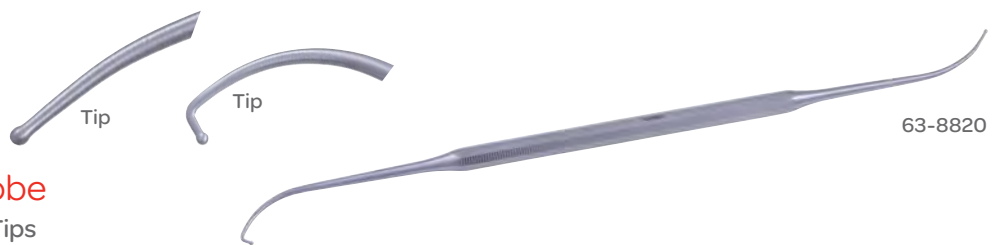

Ostium Seeker Probe

With Double-Ended Ball Tips

CODE	DESCRIPTION	ANGLE	BALL TIPS	LENGTH
63-8820	Frontal Sinus	One End 90°		8 ¹ / ₄ in 210 mm
63-8825	Maxillary Sinus		2.3 and 2.6 mm	8 ¹ / ₄ in 210 mm

Probes (Sinus)

Skillern Sinus Probe

CODE	DESCRIPTION	LENGTH
09-1300	Malleable with Centimeter Graduations at 50 mm, 70 mm and 90 mm	6 1/2 in 165 mm

Punches (Sinus)



Access Down Biting Punch

CODE	DESCRIPTION	DIAMETER	WORKING LENGTH
11-311	90° Down Biter, Left	3.8 mm	4 5/8 in 115 mm
11-321	90° Down Biter, Right	3.8 mm	4 5/8 in 115 mm

Punches (Adenoid)



King Adenoid Punch

CODE	DESCRIPTION	BITE	BASKET	LENGTH
72-6179	Triangular Basket	6 mm	7 mm	7 in 175 mm

Punches (Adenoid)

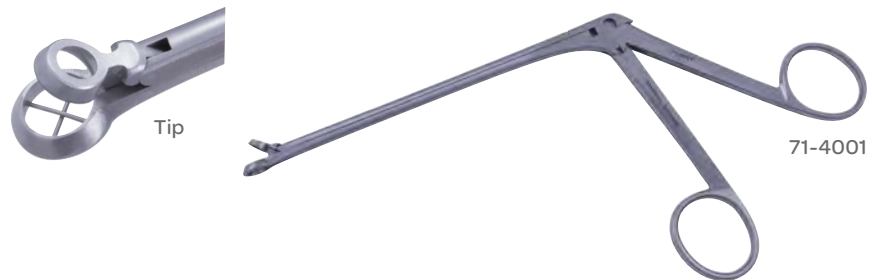

Meltzer Adenoid Punch

CODE	DESCRIPTION	BASKET	SHAFT	BITE	LENGTH
71-4001	#1	6 mm, Round	120 mm	5 mm	8 ¼ in 210 mm
71-4002	#2	7 mm, Round	120 mm	7 mm	8 ¼ in 210 mm

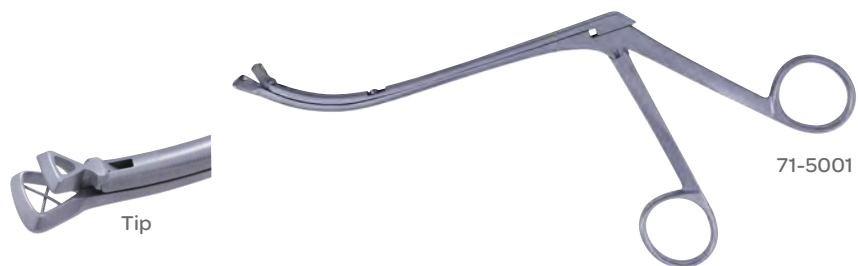

Ronis Adenoid Punch

CODE	DESCRIPTION	SIZE	LENGTH
71-5001	#1, Triangular Basket, Curved Up, Shaft 120 mm	7 mm Basket	8 ¼ in 210 mm
71-5002	#2, Triangular Basket, Curved Up, Shaft 120 mm	8 mm Basket	8 ¼ in 210 mm



Meltzer Adenoid Punch

CODE	DESCRIPTION	BASKET	SHAFT	BITE	LENGTH
71-5220	#0	5 mm, Triangular	120 mm	4 mm	7 ¾ in 197 mm
71-5222	#1	7 mm, Triangular	120 mm	6 mm	7 ¾ in 197 mm

Punches (Sinus & Nasal)

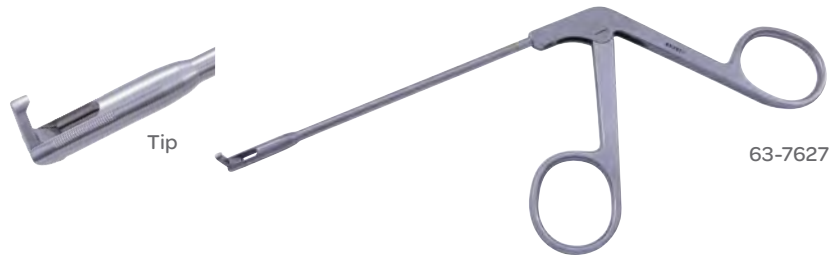

Backbiting Antrum Punch

Adult, 2.5 x 7 mm Bite, Shaft 90 mm

CODE	DESCRIPTION	LENGTH
63-7625	Straight	7 ³ / ₈ in 187 mm
63-7627	Left Side Cutting	7 ³ / ₈ in 187 mm
63-7626	Right Side Cutting	7 ³ / ₈ in 187 mm



Antrum Cutting Punch

CODE	DESCRIPTION	BITE	LENGTH
63-7610	45° Backward Cutting	4 x 5 mm	8 ¹ / ₄ in 210 mm
63-7615	45° Forward Cutting	4 x 5 mm	8 ¹ / ₄ in 210 mm
63-7631	90° Down Cutting	4 x 8 mm	8 ¹ / ₄ in 210 mm
63-7630	90° Up Cutting	4 x 8 mm	8 ¹ / ₄ in 210 mm



Circular Cutting Antrum Punch

Allows Cutting 360° without Rotating the Instrument

CODE	DESCRIPTION	BITE	SHAFT
63-7453	Straight	3.5 mm	7 in 180 mm
63-7454	Straight	4.5 mm	7 in 180 mm
63-7455	65° Degree Upturn	3.5 mm	6 ³ / ₄ 170 mm

Punches (Sinus & Nasal)

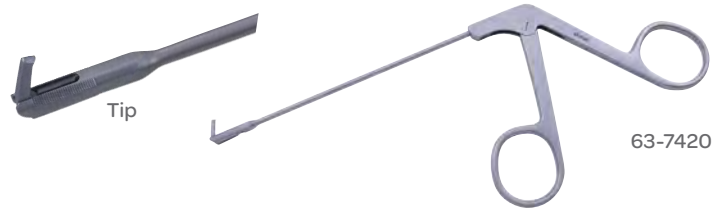

Pediatric Backbiting Antrum Punch

CODE	DESCRIPTION	BITE	SHAFT	LENGTH
63-7420	Straight	1.5 x 5 mm	4 1/8 in 105 mm	8 1/4 in 210 mm
63-7422	Left Side Cutting	1.5 x 5 mm	4 1/8 in 105 mm	8 1/4 in 210 mm
63-7421	Right Side Cutting	1.5 x 5 mm	4 1/8 in 105 mm	8 1/4 in 210 mm

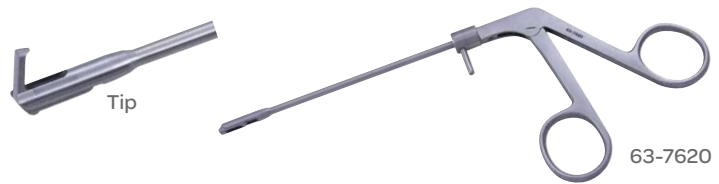

Rotating Backbiting Antrum Punch

With Post for One Hand Rotation of 360°

CODE	DESCRIPTION	BITE	SHAFT	LENGTH
63-7415	Pediatric	1.5 x 5 mm	100 mm	8 in 203 mm
63-7416	Pediatric	1.5 x 5 mm	100 mm	8 1/2 in 215 mm
63-7620	Adult	2.5 x 7 mm	100 mm	8 in 200 mm



Side Biting Antrum Punch

Thru-Punch, Designed to Cut Down, Right, Left and Forward

CODE	DESCRIPTION	SHAFT	LENGTH
63-7452	Left Side Cuts Down and Sideways	3 7/8 in 100 mm	8 1/2 in 215 mm
63-7451	Right Side Cuts Down and Sideways	3 7/8 in 100 mm	8 1/2 in 215 mm



Access Small Punch

CODE	DESCRIPTION	DIAMETER	WORKING LENGTH
11-301	Straight	3.3 mm	3 7/8 in 97 mm
11-341	Up 45°	3.3 mm	3 3/5 in 94 mm

Punches (Sinus & Nasal)



Access Medium Punch

CODE	DESCRIPTION	DIAMETER	WORKING LENGTH
11-302	Straight	4 mm	3 7/8 in 97 mm
11-342	Up 45°	4 mm	3 3/8 in 94 mm



Access Large Punch

CODE	DESCRIPTION	DIAMETER	WORKING LENGTH
11-303	Straight	6.1 mm	4 in 100 mm
11-343	Up 45°	6.1 mm	3 7/8 in 97 mm



Hajek-Kofler Punch

CODE	DESCRIPTION	JAWS	SHAFT	LENGTH
66-3810	360° Rotatable	3 x 7 mm Solid Biting	5 7/8 in 150 mm	9 1/2 in 240 mm



Access Suction Punch

CODE	DESCRIPTION	DIAMETER	WORKING LENGTH
11-402	Straight	4 mm	3 5/8 in 93 mm
11-442	Up 45°	4 mm	3 5/8 in 93 mm

Punches (Sinus & Nasal)

Access Toffel Punch

Thru-Cutting



CODE	DESCRIPTION	DIAMETER	WORKING LENGTH
11-371	Left	3 mm	3 7/8 in 97 mm
11-372	Right	3 mm	3 7/8 in 97 mm

Punches (Sphenoid)

McKenty Sphenoid Punch



CODE	DESCRIPTION	JAWS	SHAFT	LENGTH
66-3812	360° Rotatable	1.5 x 4 mm Thru-Biting	5 5/8 in 145 mm	7 in 175 mm

Sphenoid Punch

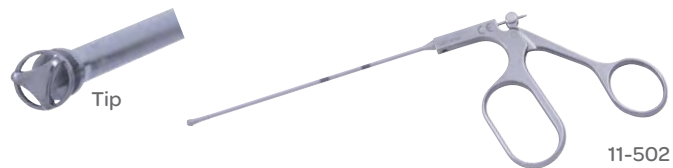

CODE	DESCRIPTION	WORKING LENGTH
11-502	3.5 mm	4 1/2 in 115 mm
11-504	4.5 mm	4 1/2 in 115 mm

Rasps (Bone & Skin)

Bone & Skin Rasp

CODE	DESCRIPTION	LENGTH
26-0513	Bone and Skin Rasp	5 1/8 in 130 mm

Rasps (Middle Ear)



61-0429

McGee Oval Window Rasp

CODE	DESCRIPTION	ANGLE	DIAMETER	LENGTH
61-0429	Small	20°	0.4 mm	6 ½ in 165 mm
61-0430	Large	20°	0.7 mm	6 ½ in 165 mm

Rasps (Nasal)



67-5941

Aufricht Nasal Rasp

CODE	WIDTH	CUTTING DIRECTION	LENGTH
67-5941	8 mm	Down-Cutting	8 ¼ in 210 mm
67-5942	8 mm	Up-Cutting	8 ¼ in 210 mm



Fomon Nasal Rasp

CODE	DESCRIPTION	LENGTH
67-5960	Double-Ended, with 4 Working Surfaces, 2 Surfaces with Fine and 2 with Coarse Serrations, Flat and Convex	8 ¾ in 220 mm

Peet Nasal Rasp

CODE	DESCRIPTION	LENGTH
63-0560	Straight, Fine Tungsten Carbide Dust Surface	7 ½ in 190 mm



Rasps (Sinus & Nasal)

Good Antrum Rasp

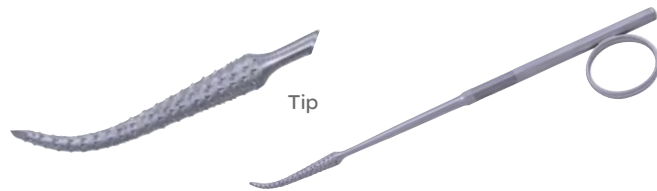

CODE	LENGTH
67-5920	6¾ in 170 mm

Wiener Antrum Rasp



66-6233

CODE	TIP	LENGTH
66-6232	Extra-Small Trocar	7½ in 190 mm
66-6234	Small Trocar	7½ in 190 mm
66-6233	Large Trocar	7½ in 190 mm

Dingman Otoabrader Rasp

10 Fine Teeth

CODE	DESCRIPTION	LENGTH
67-5912	Curved Left	6¼ in 160 mm
67-5911	Curved Right	6¼ in 160 mm



60-6054

Obwegeser Push Pull Rasp

One Working End Operates by Pushing, the Other End by Pulling

CODE	DESCRIPTION	LENGTH
67-6051	Straight, Delicate	7½ in 190 mm
67-6052	Straight, Medium/Fine	7½ in 190 mm
67-6053	Curved, Delicate	7½ in 190 mm
67-6054	Curved, Medium/Fine	7½ in 190 mm
67-6055	Concave, Delicate	7½ in 190 mm
67-6056	Concave, Medium/Fine	7½ in 190 mm

Rasps (Sinus & Nasal)

Tungsten Carbide Rasp

Straight, Double-Ended, Down-Cutting



CODE	DESCRIPTION	LENGTH
63-0516	Very Fine Grit #1 and Fine Grit #2	8 ¼ in 210 mm
63-0518	Fine Grit #3 and Coarse Grit #4	8 ¼ in 210 mm
63-0520	Coarse Grit #5 and Coarse Grit #6	8 ¼ in 210 mm
63-0522	Coarse Grit #7 and Very Coarse Grit #8	8 ¼ in 210 mm

Aufricht-Glabella Rasp



CODE	DESCRIPTION	LENGTH
67-5940	Curved Backwards, Cross Serrated, Up - and Down-Cutting	7 ½ in 190 mm

Cottle Rasp

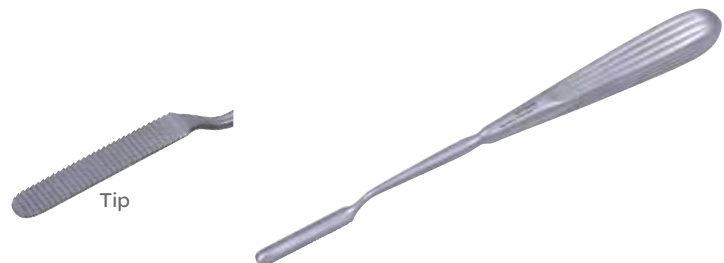

CODE	DESCRIPTION	LENGTH
67-5935	24 Straight, Fine, Down-Cutting Teeth	8 ¼ in 210 mm

Fomon Rasp

Double-Ended Convex and Flat Ends, Down-Cutting



CODE	DESCRIPTION	LENGTH
63-0511	Fine Teeth	8 ⅜ in 212 mm
63-0512	Coarse Teeth	8 ⅜ in 212 mm

EAR, NOSE & THROAT

Rasps (Sinus & Nasal)



63-0503

Joseph Rasp

CODE	DESCRIPTION	WIDTH	LENGTH
63-0503	Fine, Single-Ended	2 mm Wide	7¼ in 185 mm
63-0504	Course, Single-Ended	2 mm Wide	7¼ in 185 mm

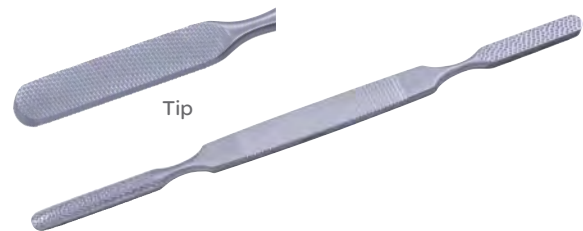

Tip

Kleinert-Kutz Rasp

Double-Ended with One Flat End and One Convex End

CODE	DESCRIPTION	LENGTH
67-5970	Coarse Teeth on One Side and Fine Teeth on the Other Side	8½ in 215 mm

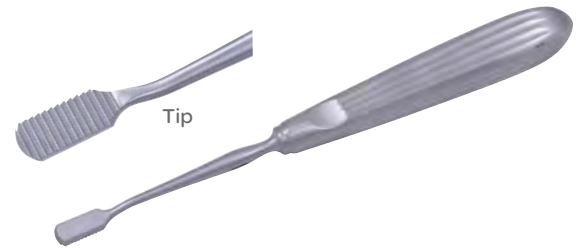

Tip

Lewis Rasp

CODE	DESCRIPTION	LENGTH
67-5930	Down-Cutting Teeth	7 in 175 mm

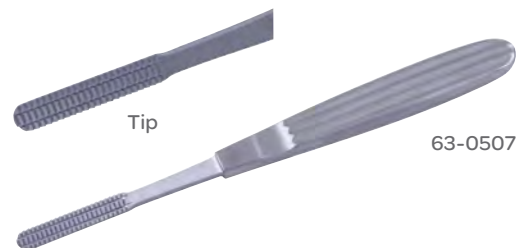

Tip

63-0507

Maltz Rasp

CODE	DESCRIPTION	LENGTH
63-0507	Down-Cutting Pattern	6½ in 165 mm
63-0508	Up-Cutting Pattern	6½ in 165 mm

Rasps (Sinus & Nasal)



Maltz Rasp

Fine Tungsten Carbide Inserts

63-0551

CODE	DESCRIPTION	LENGTH	
63-0551	Down-Cutting Pattern	7 in	170 mm
63-0550	Up-Cutting Pattern	7 in	170 mm

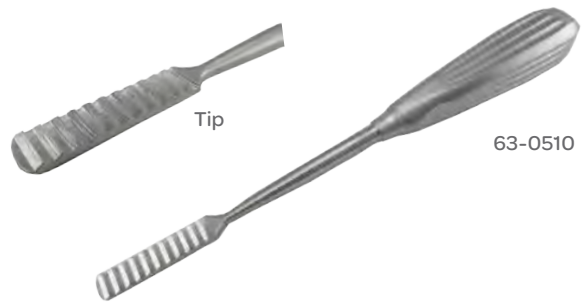

Parkes Rasp

Down-Cutting

63-0510

CODE	DESCRIPTION	LENGTH	
63-0509	20 Fine, Concave Teeth	7 3/4 in	195 mm
63-0510	11 Coarse, Concave Teeth	7 3/4 in	195 mm



63-0498

Rasp

Fine Tungsten Carbide Dust Teeth

CODE	DESCRIPTION	SURFACE	LENGTH	
63-0500	Straight	Convex	7 1/2 in	190 mm
63-0501	Straight	Concave	7 1/2 in	190 mm
63-0505	Straight	Concave	7 1/2 in	190 mm
63-0506	Curved	Convex	7 1/2 in	190 mm
63-0494	Curved Backwards	Convex	7 1/2 in	190 mm
63-0495	Curved Backwards	Concave	7 1/2 in	190 mm
63-0496	Curved Backwards	Flat	7 1/2 in	190 mm
63-0498	Curved Forward	Convex	7 1/2 in	190 mm
63-0498	Curved Forward	Concave	7 1/2 in	190 mm
63-0499	Curved Forward	Flat	7 1/2 in	190 mm

Retractors (Cheek)

Cheek Retractor



CODE	DESCRIPTION	LENGTH
72-0240	With Swivel	8¼ in 209 mm

Retractors (Hand-Held)

Aufricht Retractor



CODE	WIDTH	LENGTH
67-2135	45 mm	7⅞ in 180 mm
67-2136	60 mm	7⅞ in 180 mm
67-2137FO	70 mm, Fiber Optic Light Guide	7 in 175 mm

Blair (Rollet) Retractor

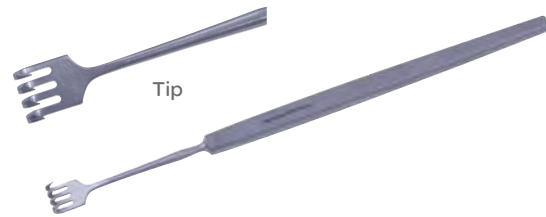

CODE	WIDTH	PRONGS	LENGTH
63-4010	6 mm	4 Sharp	5 in 125 mm

Cottle Retractor

Double-Prong, One Sharp and One Ball Tip



CODE	DESCRIPTION	LENGTH
67-2021	Right Prong, Sharp	5½ in 140 mm
67-2022	Left Prong, Sharp	5½ in 140 mm

Retractors (Hand-Held)

Cottle-Neivert Retractor

Knife Guide and Retractor



CODE	DESCRIPTION	PRONGS	WIDTH	LENGTH
67-2051	Double-Ended	Ball		7 3/4 in 195 mm
67-2052	Double-Ended	Blunt	10 mm	8 1/4 in 210 mm

Crile Retractor



CODE	DESCRIPTION	LENGTH
20-0930	Double-Ended	4 3/8 in 110 mm

Heiss Retractor



CODE	PRONGS	LENGTH
24-0909	4 x 4 Prongs, Sharp	4 in 100 mm
24-0910	4 x 4 Prongs, Blunt	4 in 100 mm

EAR, NOSE & THROAT

Retractors (Tracheal)

Jackson Tracheal Tenaculum



CODE	DESCRIPTION	LENGTH
20-4014	Single Prong	5 3/4 in 145 mm

Retractors (Hand-Held)



Knapp Retractor

CODE	WIDTH	PRONGS	LENGTH
20-5516	6 mm	4 Sharp	5 in 125 mm
20-5517	6 mm	4 Blunt	5 in 125 mm

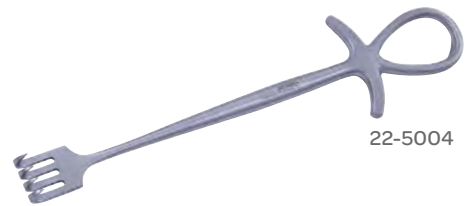

Murphy Retractor

CODE	PRONGS	LENGTH
22-5002	2 Sharp	7 3/4 in 195 mm
22-5004	4 Sharp	7 3/4 in 195 mm
22-5006	6 Sharp	7 3/4 in 195 mm
22-5102	2 Blunt	7 3/4 in 195 mm
22-5103	3 Blunt	7 3/4 in 195 mm
22-5104	4 Blunt	7 3/4 in 195 mm
22-5106	6 Blunt	7 3/4 in 195 mm



Perkins Retractor

Three Sharp Prongs and Solid Blades with Spikes

CODE	DESCRIPTION	SPREAD	LENGTH
66-6650	3 Prongs on Left with Solid Blade Right	5 in 125 mm	5 in 125 mm
66-6651	3 Prongs on Right with Solid Blade Left	5 in 125 mm	5 in 125 mm

Ragnell Retractor

Double-Ended



CODE	BLADES	LENGTH
20-0525	2.5 mm 5 mm	6 1/4 in 160 mm

Retractors (Tracheal)

Ragnell Retractor

Double-Ended



CODE	BLADES	LENGTH
20-0526	3 mm 5 mm	6 ¼ in 160 mm

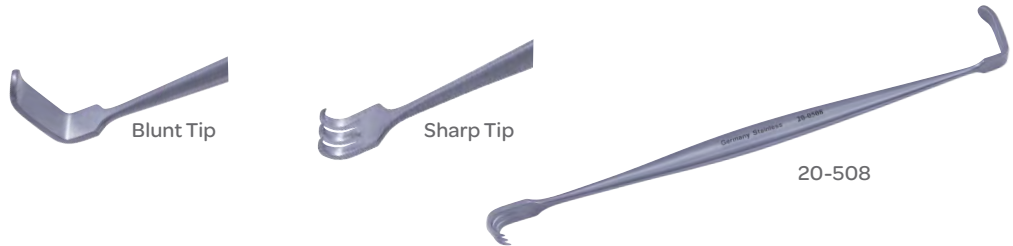

Senn Retractor

Double-Ended

CODE	PRONGS	LENGTH
20-0508	Sharp	6 ¼ in 160 mm
20-0509	Blunt	6 ¼ in 160 mm



Volkman Retractor

CODE	PRONGS	LENGTH
22-3402	2 Sharp	8 ¾ in 220 mm
22-3403	3 Sharp	8 ¾ in 220 mm
22-3404	4 Sharp	8 ¾ in 220 mm
22-3406	6 Sharp	8 ¾ in 220 mm
22-3502	2 Blunt	8 ¾ in 220 mm
22-3503	3 Blunt	8 ¾ in 220 mm
22-3504	4 Blunt	8 ¾ in 220 mm
22-3506	6 Blunt	8 ¾ in 220 mm

Retractors (Hook, Tracheal, Middle Ear)



Fomon Hook Retractor

CODE	DESCRIPTION	WIDTH	LENGTH
67-2025	Ball Tipped Prongs	13 mm	6 ¾ in 170 mm



Jackson Tracheal Retractor

CODE	DESCRIPTION	LENGTH
20-0708	Double-Ended	6 ¾ in 170 mm



Endaural Retractor

CODE	DESCRIPTION	WORKING LENGTH	OVERALL LENGTH
61-0601	T-Model	3 in 76 mm	4 ¼ in 108 mm

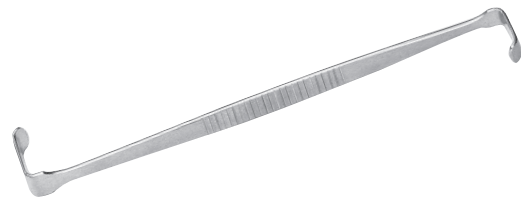

House Hand Retractor

CODE	DESCRIPTION	LENGTH
61-0600	5 x 16 mm and 9 x 25 mm Blades	6 in 150 mm

Retractors (Middle Ear, Nasal)

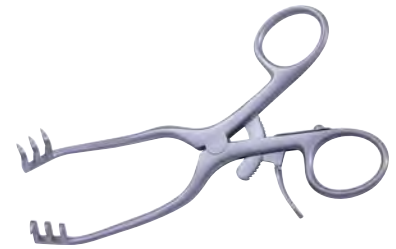

Schuknecht Retractor

CODE	DESCRIPTION	PRONGS	LENGTH
24-2620	Double Curved Arms	3 x 3 Sharp	5 1/8 in 130 mm

Schuknecht Retractor

CODE	DESCRIPTION	PRONGS	DEEP	LENGTH
24-2625	Arms Curved Downwards	3 x 3 Sharp	17 mm	5 1/8 in 130 mm



61-0605

Bellucci-Wullstein Retractor

CODE	DESCRIPTION	BLADE	PRONGS	LENGTH
61-0605	Solid Blade on Right	10 x 20 mm	Two Blunt	5 in 125 mm
61-0606	Solid Blade on Left	10 x 20 mm	Two Blunt	5 in 125 mm



63-4022

Converse Nasal Retractor

CODE	LENGTH
63-4022	4 3/8 in 112 mm

Retractors (Tonsil & Laryngeal)



Hurd Dissector & Pillar Retractor

CODE	DESCRIPTION	LENGTH
72-2522	7 mm Dissector, 11 mm Retractor	8½ in 215 mm

Retractors (Nasal)



Cottle Nasal Retractor

CODE	WIDTH	PRONGS	LENGTH
67-2044	10 mm	4 Blunt	6 in 150 mm

Retractors (Orbital)



Sewall Orbital Retractor

CODE	BLADE	LENGTH
63-4003	7x52 mm	6¾ in 170 mm
63-4004	9x51 mm	6¾ in 170 mm
63-4005	11x50 mm	6¾ in 170 mm

Retractors (Scalp)



Jansen Scalp Retractor

CODE	PRONGS	LENGTH
24-1310	3x3 Sharp	4 in 100 mm
24-1320	3x3 Blunt	4 in 100 mm
24-1321	4x4 Blunt	4 in 100 mm

Retractors (Self-Retaining)



24-1011

Alm Retractor

CODE	PRONGS	LENGTH
24-1007	4 x 4 Sharp	2¾ in 70 mm
24-1010	4 x 4 Sharp	4 in 100 mm
24-1008	4 x 4 Blunt	2¾ in 70 mm
24-1011	4 x 4 Blunt	4 in 100 mm



Pediatric Weitlaner Retractor

CODE	PRONGS	LENGTH
61-0610	3 x 3 Blunt	4½ in 115 mm

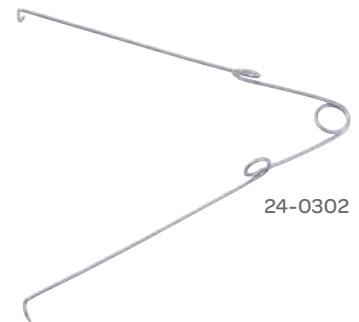

24-0302

Spring Retractor

CODE	PRONGS	DESCRIPTION	LENGTH
24-0301	1x1 Sharp		3½ in 90 mm
24-0302	1x1 Sharp		4½ in 115 mm
24-0352	1x1 Sharp	With Ratchet	4⅛ in 105 mm
24-0303	3 x 3 Blunt		3½ in 90 mm
24-0304	3 x 3 Blunt		4½ in 115 mm

Retractors (Self-Retaining)



24-2210

Weitlaner Retractor

CODE	PRONGS	LENGTH
24-2210	2 x 3, Sharp	4 ½ in 115 mm
24-2213	3 x 4, Sharp	5 ½ in 140 mm
24-2216	3 x 4, Sharp	6 ½ in 165 mm
24-2220	3 x 4, Sharp	8 in 200 mm
24-2224	3 x 4, Sharp	9 in 230 mm
24-2211	2 x 3, Blunt	4 ½ in 115 mm
24-2214	3 x 4, Blunt	5 ½ in 140 mm
24-2217	3 x 4, Blunt	6 ½ in 165 mm
24-2221	3 x 4, Blunt	8 in 200 mm
24-2225	3 x 4, Blunt	9 in 230 mm



24-2614

Wullstein-Weitlaner Retractor

CODE	DESCRIPTION	PRONGS	DEEP	LENGTH
24-2613	Arms Angled Downwards	3 x 3 Sharp	12 mm	5 ⅛ in 130 mm
24-2614	Arms Angled Downwards	3 x 3 Blunt	12 mm	5 ⅛ in 130 mm



Converse Alar Retractor

CODE	DESCRIPTION	WIDTH	LENGTH
67-2010	Double-Ended, Sharp	10 mm and 14 mm	4 ¾ in 120 mm

Retractors (Sinus & Nasal)

Cottle Alar Retractor



CODE	DESCRIPTION	LENGTH
67-2115	Tapered End 16 mm–13 mm	5½ in 140 mm

Converse Blade Retractor



CODE	DESCRIPTION	LENGTH
63-4017	9 x 18 mm	3¾ in 95 mm
63-4018	12 x 21 mm	3¾ in 95 mm
63-4019	12 x 38 mm	3¾ in 95 mm
63-4020	12 x 53 mm	3¾ in 95 mm

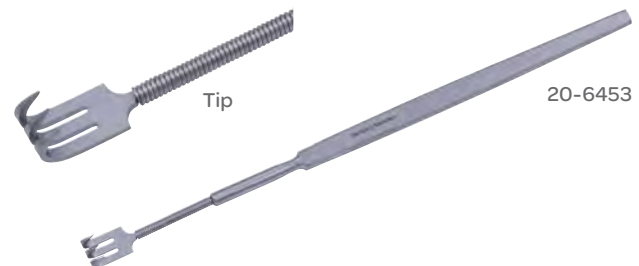

Flexible Neck Retractor

CODE	PRONGS	LENGTH
20-6452	2 Sharp	6¼ in 160 mm
20-6453	3 Sharp	6¼ in 160 mm
20-6552	2 Blunt	6¼ in 160 mm
20-6553	3 Blunt	6¼ in 160 mm

Retractors (Thymus)



Lukens Thymus Retractor

CODE	DESCRIPTION	LENGTH
20-0707	Double-Ended	6 ³ / ₄ in 170 mm

Retractors (Thyroid)



Green Thyroid Retractor

CODE	DESCRIPTION	LENGTH
23-3512	Fenestrated Blade	8 ¹ / ₂ in 215 mm



Lahey Thyroid Retractor

CODE	DESCRIPTION	LENGTH
23-0306	6 mm x 3 mm	7 ³ / ₄ in 195 mm

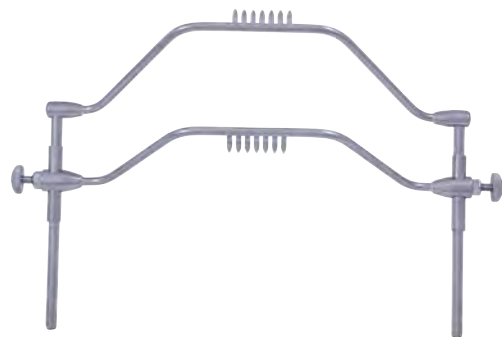

Mahorner Thyroid Retractor

CODE	DESCRIPTION	LENGTH
24-0888	7 Prong, 4 in, 100 mm Spread	10 ¹ / ₂ in 265 mm

Retractors (Uvula)

Goodyear Uvula Retractor



CODE	DESCRIPTION	LENGTH
71-6348	15 mm	7 ½ in 190 mm

Lothrop Uvula Retractor

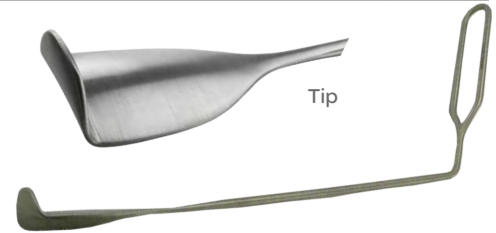

CODE	DESCRIPTION	LENGTH
71-6360	17 x 20 mm	8 in 200 mm

Love Uvula Retractor



CODE	WIDTH	LENGTH
71-6318	18 mm	6 ½ in 165 mm
71-6320	20 mm	6 ½ in 165 mm

Retractors (Vein)

Cushing Vein Retractor



CODE	WIDTH	LENGTH
20-1708	8 mm	8 in 200 mm
20-1710	10 mm	8 in 200 mm
20-1712	12 mm	8 in 200 mm
20-1714	14 mm	8 in 200 mm
20-1716	16 mm	8 in 200 mm
20-1718	18 mm	8 in 200 mm

Retractors (Cheek & Tongue)



University of Minnesota Cheek Retractor & Tongue Depressor

CODE	LENGTH
72-0210	5½ in 140 mm

Rongeurs (Bone)

Beyer Bone Rongeur

CODE	DESCRIPTION	JAWS	LENGTH
30-7102	Slender	2 mm	6¾ in 170 mm
30-7103	Slender	3 mm	7 in 175 mm



30-7103

Friedman Bone Rongeur

CODE	DESCRIPTION	JAWS	LENGTH
30-0514	Delicate	4 x 11 mm	5½ in 140 mm
30-0516	Curved	4 x 11 mm	5½ in 140 mm

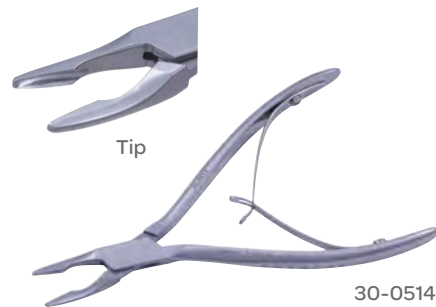

30-0514

Micro Friedman Rongeur

Very Delicate

CODE	DESCRIPTION	JAWS	LENGTH
30-0201	Straight	1.3 mm	5½ in 140 mm
30-0203	Straight	2 mm	5½ in 140 mm
30-0202	Curved	1.3 mm	5½ in 140 mm
30-0204	Curved	2 mm	5½ in 140 mm



30-0202

Rongeurs (Bone)

Jansen Bone Rongeur

CODE	DESCRIPTION	JAWS	LENGTH
30-5018	Straight	4 mm	7 in 175 mm
30-5118	Curved	4 mm	7 in 175 mm



31-5018

Ruskin-Mini Bone Rongeur

Double Action

CODE	DESCRIPTION	JAWS	LENGTH
31-0402	Straight	2 mm	6 in 150 mm
31-0502	Straight	2 mm	6 in 150 mm
31-0403	Curved	3 mm	6 in 150 mm
31-0503	Curved	3 mm	6 in 150 mm

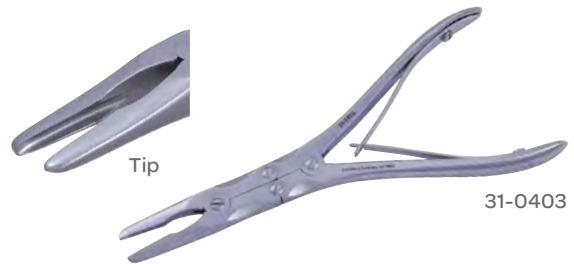

31-0403

Rongeurs (Kerrison)

Kerrison Rongeur

CODE	DESCRIPTION	LENGTH
62-6203	#0 3 mm Bite	6 3/4 in 170 mm
62-6204	#1 4 mm Bite	6 3/4 in 170 mm
62-6205	#2 5 mm Bite	6 3/4 in 170 mm
62-6206	#3 6 mm Bite	6 3/4 in 170 mm



62-6203

Kerrison-Costen Rongeur

90° Bite on Curved Shaft

CODE	SHAFT	LENGTH
63-5010	102 mm 3x3 mm	5 1/2 in 140 mm



Rongeurs (Synovectomy)

Kleinert-Kutz Synovectomy Rongeur

Single Action

CODE	DESCRIPTION	JAW WIDTH	LENGTH
30-7613	Slightly Curved	2 mm	5½ in 140 mm
30-7614	Fully Curved	2 mm	5½ in 140 mm

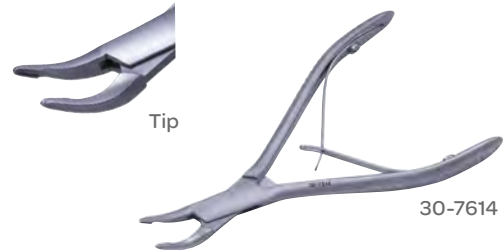

Kleinert-Kutz Synovectomy Rongeur

Double Action

CODE	DESCRIPTION	JAW WIDTH	LENGTH
31-0552	Slightly Curved	2x13 mm	6 in 150 mm
31-0553	Slightly Curved	3x16mm	6 in 150 mm
31-0554	Fully Curved	3x8.0mm	6 in 150 mm

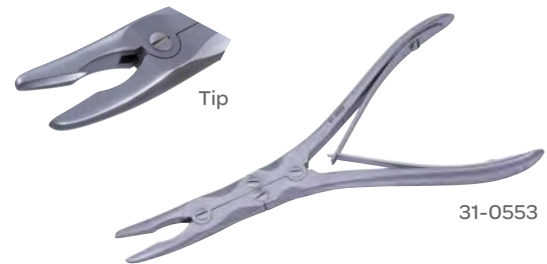

Beyer Rongeur

Double Action

CODE	DESCRIPTION	JAW WIDTH	LENGTH
31-1003	Curved	3 mm	7⅛ in 180 mm
31-1104	Curved	4 mm	7⅛ in 180 mm



Blumenthal Rongeur

CODE	DESCRIPTION	JAW WIDTH	LENGTH
30-2547	30° Angle	4 mm	6¼ in 160 mm
30-2545	45° Angle	4 mm	6¼ in 160 mm
30-2546	90° Angle	4 mm	6¼ in 160 mm



Rongeurs (Synovectomy)

Citelli Rongeur

Serrated Bite

CODE	DESCRIPTION	BITE	LENGTH
62-6251	9.5 mm Shaft	#1, 1.5 x 4 mm	5½ in 140 mm
62-6252	8.5 mm Shaft	#2, 2.5 x 4 mm	5½ in 140 mm



62-6252

Goldman-Kazanjian Rongeur

CODE	DESCRIPTION	JAW WIDTH	LENGTH
30-8000	Straight Handle	17 mm	7 in 175 mm



Jansen Rongeur

CODE	DESCRIPTION	JAW WIDTH	LENGTH
30-7959	Bayonet Shaped	4 mm	6¾ in 170 mm



Juers-Lempert Rongeur

Jaws on Curved Handles

CODE	HANDLE	JAW WIDTH	LENGTH
30-7621	Straight	3 mm Wide	7½ in 190 mm

Rongeurs (Synovectomy)

Leksell Rongeur

Double Action

CODE	DESCRIPTION	JAW WIDTH	LENGTH
31-5103	Lightly Curve	3 mm	9 in 228 mm
31-5105	Lightly Curve	5 mm	9 in 228 mm
31-5108	Lightly Curve	8 mm	9 in 228 mm
31-5303	Fully Curved	3 mm	9 in 228 mm
31-5305	Fully Curved	5 mm	9 in 228 mm
31-5308	Fully Curved	8 mm	9 in 228 mm



Lempert Rongeur

2.5 mm Jaws

CODE	DESCRIPTION	HANDLE	LENGTH
30-7620	Straight	Slender Pattern	6¼ in 160 mm
30-7624	Straight	Slender Pattern	7½ in 190 mm
30-7619	Straight	Heavy Pattern	7½ in 190 mm
30-7623	Curved	Slender Pattern	7¼ in 185 mm
30-7625	Curved	Slender Pattern	7½ in 190 mm
30-7622	Strong Curved	Slender Pattern	6¼ in 160 mm

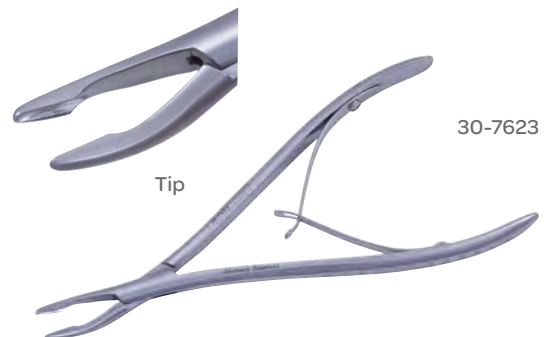

Zaufel-Jansen Rongeur

Double Action

CODE	DESCRIPTION	WIDTH	LENGTH
31-1105	Curved	5 mm	7⅛ in 180 mm



Saws (Nasal)

Joseph Bayonet Saw

CODE	DESCRIPTION	LENGTH
67-6010	Straight	7¼ in 185 mm
67-6011	Angled Left	7¼ in 185 mm
67-6012	Angled Right	7¼ in 185 mm



Maltz-Joseph Saw

CODE	DESCRIPTION	WORKING LENGTH
67-6021	Angled Left	3¼ in 83 mm
67-6022	Angled Right	3¼ in 83 mm



Scissors (Alligator)

Bellucci Alligator Scissors

CODE	DESCRIPTION	SHAFT	BLADES	LENGTH
61-0706	Straight	74 mm	5 mm	5¼ in 135 mm
61-0710	Straight	77 mm	7 mm	5¼ in 135 mm
61-0710E	Straight, Ebonized	77 mm	7 mm	5¼ in 135 mm
61-0707	Curved Left	74 mm	5 mm	5¼ in 135 mm
61-0704	Curved Left	75 mm	7 mm	5¼ in 135 mm
61-0708	Curved Right	74 mm	5 mm	5¼ in 135 mm
61-0705	Curved Right	75 mm	7 mm	5¼ in 135 mm
61-0708E	Curved Right, Ebonized	74 mm	5 mm	5¼ in 135 mm

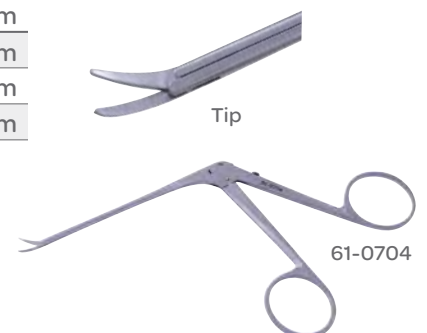

Scissors (Alligator)

Luetje Alligator Scissors

90 mm Shaft

CODE	DESCRIPTION	BLADES	LENGTH
61-0712	Straight	4 mm	5 ¼ in 135 mm

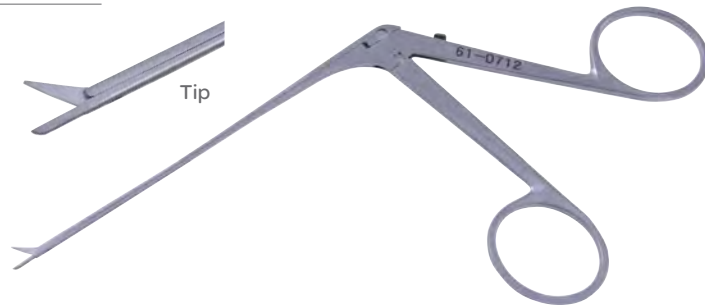

Scissors (Dissecting)

Brown Dissecting Scissors

Narrow Blades

CODE	DESCRIPTION	LENGTH
04-5075	Straight	5 ¾ in 145 mm
04-5076	Curved	5 ½ in 140 mm



Kaye Dissecting Scissors

Serrated

CODE	DESCRIPTION	LENGTH
67-5120	Straight	4 ¾ in 108 mm
67-5121	Curved	4 ¾ in 108 mm



Scissors (Dorsal)

Converse Dorsal Scissors

CODE	DESCRIPTION	LENGTH
67-5511	Serrated Blades	6½ in 165 mm

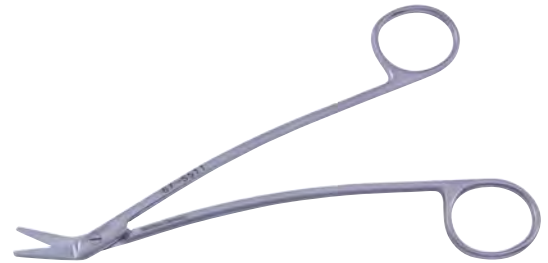

Cottle Dorsal Scissors

Angled Handle

CODE	DESCRIPTION	LENGTH
67-5316	Heavy Pattern	6 in 150 mm



Cottle Dorsal Scissors

Angled Handle

CODE	DESCRIPTION	LENGTH
32-583	Tungsten Carbide	6¼ in 160 mm



Dorsal Scissors

CODE	DESCRIPTION	LENGTH
67-5508	Straight, Blunt	4¾ in 120 mm



Scissors (Dorsal)

Fomon Dorsal Scissors

Fine Tungsten Carbide Blade, Serrated Lower Blade

CODE	DESCRIPTION	LENGTH
32-572	Angled Handle	5 ⁵ / ₁₆ in 137 mm



Fomon Dorsal Scissors

Serrated Blades

CODE	DESCRIPTION	LENGTH
67-5313	Angled Handle	6 ¹ / ₂ in 165 mm

Ceramic Coated Cottle Dorsal Scissors

Razor Edges and Micro Serrations

CODE	DESCRIPTION	LENGTH
227.53.36	Ceramic Coated	6 ¹ / ₄ in 160 mm



Converse Double Edge Scissors

CODE	DESCRIPTION	LENGTH
67-5013	Straight	5 ¹ / ₈ in 130 mm

Scissors (Face Lift)

Judy Friedman Face Lift Scissors

Curved, Sharp Outer Edges

CODE	DESCRIPTION	LENGTH
67-5154	Slender Pattern	9 ⁷ / ₈ in 250 mm
67-5155	Heavy Pattern	6 ³ / ₄ in 170 mm

Scissors (Ganglion)

Adson Kelly Ganglion Scissors

Sharp Outer Edges

CODE	DESCRIPTION	LENGTH
04-5416	Straight	6 ¹ / ₄ in 160 mm
04-5516	Curved	6 ¹ / ₄ in 160 mm



04-5516

Scissors (Iris)

Knapp Iris Scissors

CODE	DESCRIPTION	LENGTH
54-6524	Straight Sharp/Blunt	4 in 102 mm
54-6526	Straight Blunt/Blunt	4 in 102 mm
54-6525	Curved Sharp/Blunt	4 in 102 mm
54-6527	Curved Blunt/Blunt	4 in 102 mm



54-6524

Scissors (Lower Lateral)

Cinelli Lower Lateral Scissors

CODE	DESCRIPTION	LENGTH
67-5211	Strong Curve	4½ in 115 mm



Fomon Lower Lateral Scissors

CODE	DESCRIPTION	LENGTH
67-5212	Strong Curve	5⅜ in 137 mm



Scissors (Micro-Laryngeal)

Jako Micro-Laryngeal Scissors

CODE	DESCRIPTION	LENGTH
74-5932	Straight, Vertical Cut	9¼ in 235 mm
74-5931	Angled Up	9¼ in 235 mm
74-5934	Curved Left, Vertical Cut	9¼ in 235 mm
74-5935	Curved Right, Vertical Cut	9¼ in 235 mm

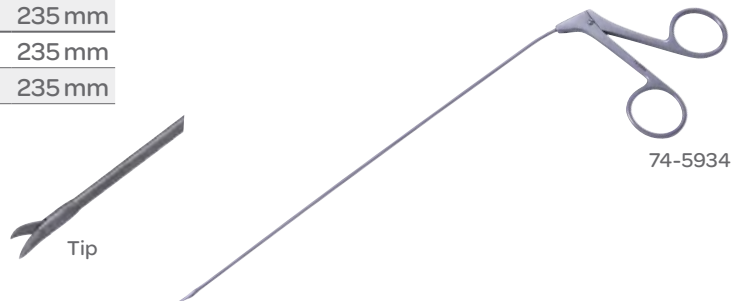

Jako-Kleinsasser Micro-Laryngeal Scissors

CODE	DESCRIPTION	LENGTH
74-5974	Straight	8⅝ in 219 mm
74-5977	Angled Left	8⅝ in 219 mm
74-5976	Angled Right	8⅝ in 219 mm
74-5975	Angled Up	8⅝ in 219 mm



Scissors (Micro-Laryngeal)

Kleinsasser Micro-Laryngeal Scissors

CODE	DESCRIPTION	BLADES	LENGTH
74-6028	Straight	4 mm	10 ³ / ₄ in 270 mm
74-6035	Straight, Serrated	4 mm	10 ³ / ₄ in 270 mm
74-6028	Curved Left	4 mm	10 ³ / ₄ in 270 mm
74-6036	Curved Left, Serrated	4 mm	10 ³ / ₄ in 270 mm
74-6030	Curved Right	4 mm	10 ³ / ₄ in 270 mm
74-6037	Curved Right, Serrated	4 mm	10 ³ / ₄ in 270 mm
74-6031	Curved Up	4 mm	10 ³ / ₄ in 270 mm
74-6038	Curved Up, Serrated	4 mm	10 ³ / ₄ in 270 mm

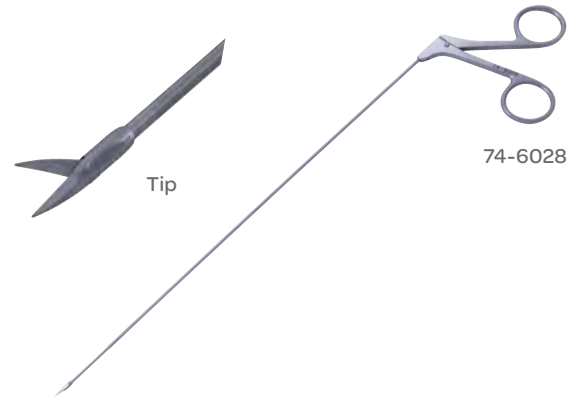

Shea-Bellucci Scissors

Extra Narrow

CODE	DESCRIPTION	BLADES	LENGTH
61-0709	Straight	8 mm	5 ¹ / ₄ in 135 mm



Scissors (Miniature)

Bellucci Miniature Scissors

CODE	DESCRIPTION	BLADES	SHAFT	LENGTH
61-0713	Straight	4 mm Sharp	75 mm	5 ¹ / ₄ in 135 mm



Scissors (Nasal)

Converse-Wilmer Nasal Scissors

CODE	DESCRIPTION	LENGTH
67-5513	Angled on Flat	4 in 135 mm



Fomon Nasal Scissors

CODE	DESCRIPTION	LENGTH
67-5112	Curved	5¼ in 125 mm



Goldman Nasal Scissors

Saber Back, Semi-Sharp Outer-Edges

CODE	DESCRIPTION	LENGTH
67-5506	Curved	5¾ in 145 mm



Knight Nasal Scissors

CODE	DESCRIPTION	LENGTH
67-5503	Standard Pattern	7 in 175 mm



Jackson Nasal Bone Scissors

Angled Blade, Serrated

CODE	DESCRIPTION	LENGTH
67-5516	Heavy Pattern	8½ in 215 mm



Scissors (Nasal)

Jameson Tenotomy Scissors

CODE	DESCRIPTION	LENGTH
80-6716	Curved	6 $\frac{1}{8}$ in 156 mm



Joseph Scissors

CODE	DESCRIPTION	LENGTH
80-5015	Straight	5 $\frac{3}{4}$ in 145 mm



Scissors (Razor Edge)

Kaye Scissors

Razor Edge

CODE	DESCRIPTION	LENGTH
80-4200	Curved	4 $\frac{1}{2}$ in 115 mm



Ragnell Scissors

Beveled Dissecting Tips

CODE	DESCRIPTION	LENGTH
80-4905	Curved	5 $\frac{1}{4}$ in 133 mm



Scissors (Removal, Rhinoplasty, Septum)

Joseph Rhinoplasty Scissors

CODE	DESCRIPTION	BLADE	LENGTH
04-5015	Straight	Sharp/Sharp	6¼ in 160 mm
04-5016	Straight	Sharp Outer Blade	6¼ in 160 mm
04-5115	Curved	Sharp/Sharp	6¼ in 160 mm
04-5116	Curved	Sharp Outer Blade	6¼ in 160 mm



04-5115

Becker Septum Scissors

CODE	DESCRIPTION	LENGTH
67-5505	Double Action, Angled Handles, Serrated	7¼ in 185 mm



Caplan Septum Scissors

CODE	DESCRIPTION	LENGTH
67-5371	Double Action, Serrated	7¾ in 197 mm



Scissors (Septum, Serrated, Sinus)

Goldman Septum Scissors

CODE	DESCRIPTION	LENGTH
67-5509	Angled Handle, Serrated	5⅞ in 150 mm



Scissors (Septum, Serrated, Sinus)

Joseph Scissors with Micro Serrations

CODE	DESCRIPTION	LENGTH
204.50.15	Straight, Gold Screw	5 3/4 in 145 mm
204.51.15	Curved, Gold Screw	5 3/4 in 145 mm



204.51.15

Sinus Scissors

Pediatric

CODE	DESCRIPTION	SHAFT	BLADES	LENGTH
63-7700	Straight	90 mm	5 mm	5 3/4 in 145 mm
63-7701	Curved Left	90 mm	5 mm	5 3/4 in 145 mm
63-7702	Curved Right	90 mm	5 mm	5 3/4 in 145 mm



63-7701

Sinus Scissors

Adult

CODE	DESCRIPTION	SHAFT	BLADES	LENGTH
63-7705	Straight, Serrated	155 mm	11 mm	8 3/4 in 222 mm
63-7706	Curved Left, Serrated	155 mm	11 mm	8 3/4 in 222 mm
63-7707	Curved Right, Serrated	155 mm	11 mm	8 3/4 in 222 mm



Tip



63-7706

Scissors (Strabismus, Suture Carrying)

Littler Suture Carrying Scissors

CODE	DESCRIPTION	LENGTH
60-1868	Curved, Cutting Blades with Hole	4 3/4 in 120 mm



Scissors (Tenotomy)

Jamison Metzenbaum Tenotomy Scissors

CODE	DESCRIPTION	LENGTH
37-4033	Curved	6 in 152 mm
37-4031	Curved	8 in 203 mm
37-4027	Curved	9 in 229 mm



37-4027

Razor Edge Scissors with Micro Serrations & Gold Screw

CODE	DESCRIPTION	LENGTH
214.67.12	Curved	4 ³ / ₄ in 120 mm
214.67.13	Curved	5 ¹ / ₈ in 130 mm
214.67.16	Curved	6 ¹ / ₄ in 158 mm



214.67.16

Potts Tenotomy Scissors

CODE	DESCRIPTION	LENGTH
37-4032	Curved	6 in 152 mm



Stevens Tenotomy Scissors

CODE	DESCRIPTION	LENGTH
54-6520	Straight	4 ¹ / ₈ in 105 mm
54-6522	Straight	4 ⁵ / ₈ in 118 mm
54-6521	Curved	4 ¹ / ₈ in 105 mm
54-6523	Curved	4 ⁵ / ₈ in 118 mm



54-6520

Scissors (Tissue and Gum, Tonsil)

Fox Tissue and Gum Scissors

Tungsten Carbide Edges

CODE	DESCRIPTION	LENGTH
32-941	Straight	5 1/8 in 130 mm
32-940	Curved	5 1/8 in 130 mm



32-941

Boettcher Tonsil Scissors

CODE	DESCRIPTION	BLADE	LENGTH
54-1081	Curved	Double-Edged, Angled on Side	7 1/4 in 184 mm
72-4525	Curved	Double-Edged	7 3/8 in 187 mm



72-4525

Dean Tonsil Scissors

CODE	DESCRIPTION	BLADE	LENGTH
72-4550	Angled	One Serrated	6 3/4 in 170 mm



Prince Tonsil Scissors

CODE	DESCRIPTION	BLADE	LENGTH
72-4520	Curved	Slender	7 5/16 in 186 mm



Scissors (Turbinate)

Gorney Turbinate Scissors

Serrated

CODE	DESCRIPTION	LENGTH
67-5515	Double Action, 33 mm Jaws	8 in 200 mm

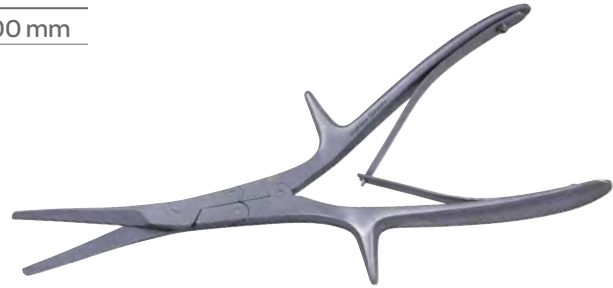

Seiler Turbinate Scissors

CODE	DESCRIPTION	LENGTH
67-5504	Heavy Pattern, Angled on Side	6¼ in 158 mm



Brophy Scissors

CODE	DESCRIPTION	LENGTH
04-2014	Straight, Sharp/Sharp	5½ in 140 mm
04-2114	Curved, Sharp/Sharp	5½ in 140 mm

Jameson Reynolds Scissors

Serrated

CODE	DESCRIPTION	LENGTH
85-2121	Curved	5¼ in 133 mm
85-2123	Curved	6¼ in 158 mm
85-2125	Curved	7 in 177 mm



85-2121

Scissors

Jameson Reynolds Scissors

Serrated with Black Handles

CODE	LENGTH
86-6713	5¼ in 133 mm
86-6716	6¼ in 158 mm



86-6716

Joseph Scissors

Serrated with Black Handles

CODE	DESCRIPTION	LENGTH
86-5015	Straight	6 in 152 mm
86-5115	Curved	6 in 152 mm



86-5115

Joseph Scissors

Serrated

CODE	DESCRIPTION	LENGTH
85-2063	Straight	6 in 152 mm
85-2064	Curved	6 in 152 mm



85-2064

Ragnell Dissecting Scissors

Beveled Dissecting Tip

CODE	DESCRIPTION	LENGTH
67-5507	Curved	5 in 127 mm



EAR, NOSE & THROAT

Snares (Nasal, Snare Wire, Tonsil)

Bruening Nasal Snare

CODE	DESCRIPTION	LENGTH
66-1510	Complete Bayonet Style W/ Snare & Stylet	8 in 203 mm
66-1512-3	Size 0 0.30 mm	Cut & Formed
66-1512-4	Size 1 0.33 mm	Cut & Formed
66-1512-5	Size 2 0.40 mm	Cut & Formed
66-1512-6	Size 3 0.50 mm	Cut & Formed

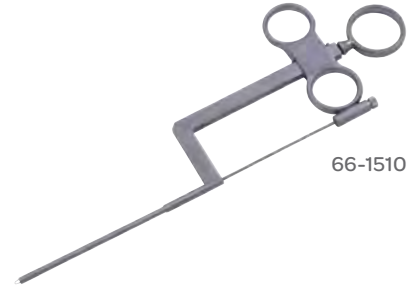

66-1510

Sage Tonsil Snare

CODE	DESCRIPTION	LENGTH
72-6011	Sage Tonsil Snare Instrument	11 in 280 mm
72-6012-6	0.35 mm	
72-6012-7	0.40 mm	
72-6012-8	0.45 mm	
72-6012-9	0.50 mm	



72-6011

Tyding Tonsil Snare

CODE	DESCRIPTION	LENGTH
72-5051		9½ in 241 mm
72-6515	Prepared Snare Wire #7	
72-6516	Prepared Snare Wire #8	
72-6517	Prepared Snare Wire #9	



72-5051

Speculums (Middle Ear, Nasal)

Shea Ear Speculum Holder

CODE	LENGTH
62-0380	11¾ in 300 mm



Cottle Nasal Speculum

Self-Retaining, Narrow Tapered Blades

CODE	BLADES	LENGTH
67-0230	30 mm	5½ in 140 mm
67-0235	35 mm	5½ in 140 mm
67-0255	55 mm	5½ in 140 mm
67-0270	70 mm	5½ in 140 mm
67-0275	75 mm	5½ in 140 mm
67-0290	90 mm	5½ in 140 mm



67-0235

Speculums (Middle Ear, Nasal)

Halle Nasal Speculum

CODE	BLADE	LENGTH
79-6669	32 mm	6 in 152 mm
63-6235	32 mm	6¼ in 160 mm



79-6669

Speculums (Nasal)

Hartmann-Halle Nasal Speculum

CODE	DESCRIPTION	BLADES	LENGTH
66-0301	Small	25 mm	6 in 152 mm
66-0302	Medium	30 mm	6 in 152 mm
66-0303	Large	32 mm	6 in 152 mm



66-0303

Tieck Infant Nasal Speculum

CODE	BLADES	LENGTH
63-6250	18 mm	5½ in 140 mm



Vienna Nasal Speculum

CODE	BLADE LENGTH	LENGTH
63-6241	24 mm	5¼ in 133 mm
79-6675	27 mm	5¼ in 133 mm
79-6676	28 mm	5¼ in 133 mm
63-6242	30 mm	5¼ in 133 mm
63-6243	32 mm	5¼ in 133 mm
79-6677	32 mm	5¼ in 133 mm
63-6244	34 mm	5¼ in 133 mm



79-6676

Speculums (Septum)

Cottle Septum Speculum

CODE	DESCRIPTION	BLADES	LENGTH
63-6270	Self-Retaining, Thin Modified	50 mm	6 in 152 mm



Killian Septum Specula & Killian Septum Speculum

Self-Retaining

CODE	BLADES	LENGTH
79-7011	51 mm	5 ¼ in 133 mm
79-7012	63 mm	5 ¼ in 133 mm
79-7013	76 mm	5 ¼ in 133 mm
63-6265	51 mm	6 in 152 mm
63-6266	64 mm	6 in 152 mm
63-6267	76 mm	6 in 152 mm
63-6268	90 mm	6 in 152 mm



79-7011

Septum Speculum

Self-Retaining, Very Narrow Blade, Ebony Finish

CODE	BLADES	LENGTH
63-2181	35 mm	5 ½ in 139 mm
63-2182	50 mm	5 ½ in 139 mm
63-2183	75 mm	5 ½ in 139 mm
63-2184	90 mm	5 ½ in 139 mm



63-2181

Tebbetts Speculum

CODE	DESCRIPTION	LENGTH
67-0242	Thin Blades 1 ¾ in (45 mm)	6 in 152 mm



Speculums (Septum)



61-0932

Farrior Speculum

CODE	SIZE	DISCRIPTION	DISTAL END
61-0980		Oval Oblique	3 x 4 mm
61-0831		Oval Oblique	3.5 x 4.8 mm
61-0982		Oval Oblique	4 x 5 mm
61-0833		Oval Oblique	4.5 x 5.3 mm
61-0931.5		Oval Oblique	4.5 x 5.5 mm
61-0834		Oval Oblique	5 x 5.8 mm
61-0931	#1	Oval Oblique	5 x 6 mm
61-0835		Oval Oblique	5.5 x 6.3 mm
61-0932.5		Oval Oblique	5.5 x 6.5 mm
61-0836		Oval Oblique	6 x 6.5 mm
61-0932	#2	Oval Oblique	6 x 7 mm
61-0933.5		Oval Oblique	6.5 x 7.5 mm
61-0933	#3	Oval Oblique	7 x 8 mm
61-0934.5		Oval Oblique	7.5 x 8.5 mm
61-0934	#4	Oval Oblique	8 x 9 mm
61-0935	#5	Oval Oblique	9 x 11 mm
61-0936	#6	Oval Oblique	10 x 12 mm
61-0937	#7	Oval Oblique	11 x 13 mm
61-0980E		Ebonized Oval Oblique	3 x 4 mm
61-0831E		Ebonized Oval Oblique	3.5 x 4.8 mm
61-0982E		Ebonized Oval Oblique	4 x 5 mm
61-0833E		Ebonized Oval Oblique	4.5 x 5.3 mm
61-0931.5E		Ebonized Oval Oblique	4.5 x 5.5 mm
61-0834E		Ebonized Oval Oblique	5 x 5.8 mm
61-0931E	#1	Ebonized Oval Oblique	5 x 6 mm
61-0835E		Ebonized Oval Oblique	5.5 x 6.3 mm
61-0932.5E	#2	Ebonized Oval Oblique	5.5 x 6.5 mm
61-0836E		Ebonized Oval Oblique	6 x 6.5 mm
61-0932E		Ebonized Oval Oblique	6 x 7 mm
61-0933.5E		Ebonized Oval Oblique	6.5 x 7.5 mm
61-0933E	#3	Ebonized Oval Oblique	7 x 8 mm
61-0934.5E		Ebonized Oval Oblique	7.5 x 8.5 mm
61-0934E	#4	Ebonized Oval Oblique	8 x 9 mm
61-0935E	#5	Ebonized Oval Oblique	9 x 11 mm
61-0936E	#6	Ebonized Oval Oblique	10 x 12 mm
61-0937E	#7	Ebonized Oval Oblique	11 x 13 mm

Speculums (Septum)



61-0932

Farrior Speculum

CODE	SIZE	DESCRIPTION	DISTAL END
61-0917	#1	Oval Regular End	4.5 x 6 mm
61-0918	#2	Oval Regular End	5.5 x 7 mm
61-0919	#3	Oval Regular End	6.5 x 8 mm
61-0920	#4	Oval Regular End	7.5 x 9 mm
61-0921	#5	Oval Regular End	8 x 10 mm
61-0922	#6	Oval Regular End	9 x 11.25 mm
61-0923	#7	Oval Regular End	10 x 12.5 mm
61-0917E	#1	Ebonized Oval Regular End	4.5 x 6 mm
61-0918E	#2	Ebonized Oval Regular End	5.5 x 7 mm
61-0919E	#3	Ebonized Oval Regular End	6.5 x 8 mm
61-0920E	#4	Ebonized Oval Regular End	7.5 x 9 mm
61-0921E	#5	Ebonized Oval Regular End	8 x 10 mm
61-0922E	#6	Ebonized Oval Regular End	9 x 11.25 mm
61-0923E	#7	Ebonized Oval Regular End	10 x 12.5 mm



61-0910

Farrior Speculum

CODE	SIZE	DESCRIPTION	DISTAL END
61-0910	#1	Round Regular End	5 mm
61-0911	#2	Round Regular End	6 mm
61-0912	#3	Round Regular End	7 mm
61-0913	#4	Round Regular End	8 mm
61-0914	#5	Round Regular End	9 mm
61-0915	#6	Round Regular End	10 mm
61-0916	#4	Round Regular End	10.5 mm
61-0910E	#1	Ebonized, Round Regular End	5 mm
61-0911E	#2	Ebonized, Round Regular End	6 mm
61-0912E	#3	Ebonized, Round Regular End	7 mm
61-0913E	#4	Ebonized, Round Regular End	8 mm
61-0914E	#5	Ebonized, Round Regular End	9 mm
61-0915E	#6	Ebonized, Round Regular End	10 mm
61-0916E	#4	Ebonized, Round Regular End	10.5 mm

Speculums (Septum)

Farrior Speculum

CODE	SIZE	DESCRIPTION	DISTAL END
61-0924	#1	Round Oblique End	6 mm
61-0925	#2	Round Oblique End	7 mm
61-0926	#3	Round Oblique End	8 mm
61-0927	#4	Round Oblique End	9 mm
61-0928	#5	Round Oblique End	10 mm
61-0929	#6	Round Oblique End	11 mm
61-0930	#7	Round Oblique End	12 mm
61-0924E	#1	Ebonized Round Oblique End	6 mm
61-0925E	#2	Ebonized Round Oblique End	7 mm
61-0926E	#3	Ebonized Round Oblique End	8 mm
61-0927E	#4	Ebonized Round Oblique End	9 mm
61-0928E	#5	Ebonized Round Oblique End	10 mm
61-0929E	#6	Ebonized Round Oblique End	11 mm
61-0930E	#7	Ebonized Round Oblique End	12 mm



61-0924E

Boucheron Speculum

Round, Chrome Plated

CODE	SIZE	DISTAL END
61-0901	#1	3 mm
61-0902	#2	4 mm
61-0903	#3	4.5 mm
61-0904	#4	5 mm
61-0906	#5	5.5 mm
61-0907	#6	7 mm
61-0908	#7	8.0 mm
61-0909	#8	9.5 mm



61-0901

Gruber Speculum

Round, Chrome Plated

CODE	DISTAL END	LENGTH
61-0979	3 mm	33 mm
61-0965	3.5 mm	35 mm
61-0966	4 mm	35 mm
61-0967	5 mm	37 mm



61-0979

Speculums (Ear)

Gruber Speculum

Oval, Chrome-Plated

CODE	DISTAL END	LENGTH
61-0975	2 x 3 mm	33 mm
61-0968	3 x 4 mm	33 mm
61-0973	3 x 5 mm	35 mm
61-0974	3 x 6 mm	37 mm
61-0969	5 x 6 mm	42 mm
61-0970	6 x 7 mm	42 mm
61-0971	7 x 8 mm	42 mm



61-0973

Hartmann Speculum

Round, Chrome-Plated

CODE	DISTAL END	LENGTH
61-0962	2.5 mm	35 mm
61-0953	4 mm	35 mm
61-0954	5 mm	35 mm
61-0955	6 mm	35 mm
61-0956	7 mm	35 mm



61-0955

Hartmann Speculum

Oval, Chrome-Plated

CODE	DISTAL END	LENGTH
61-0963	2.5 x 3 mm	35 mm
61-0958	4.5 x 5 mm	35 mm
61-0959	5.5 x 6 mm	35 mm
61-0960	6.5 x 7 mm	35 mm
61-0961	7.5 x 8 mm	35 mm



61-0958

Toynbee Speculum

Round, Chrome Plated

CODE	DISTAL END	LENGTH
61-0950	2 mm End	35 mm
61-0941	4 mm End	35 mm
61-0942	5 mm End	35 mm
61-0943	6 mm End	35 mm
61-0944	7 mm End	35 mm



61-0942

Speculums (Ear)

Toybee Speculum

Oval, Chrome Plated

CODE	DISTAL END	LENGTH
61-0939	2.5 x 3.5 mm	35 mm
61-0946	4.5 x 5 mm	35 mm
61-0947	5.5 x 6 mm	35 mm
61-0948	6.5 x 7 mm	35 mm
61-0949	7.5 x 8 mm	35 mm



61-0949

Spreaders (Middle Ear)

Guilford-Wright Loop Spreader

CODE	JAWS	SHAFT
61-0137	Pointed Serrated 7.0 mm	75 mm



Tip

Suction Tubes (Ear, Middle Ear)

Bellucci Ear Suction Tube

CODE	DESCRIPTION	TIP LENGTH	LENGTH
61-1010	18 Gauge Tip	1 3/8 in 35 mm	6 in 152 mm
61-1011	20 Gauge Tip	1 3/8 in 35 mm	6 in 152 mm
61-1012	21 Gauge Tip	1 3/8 in 35 mm	6 in 152 mm
61-1013	22 Gauge Tip	1 3/8 in 35 mm	6 in 152 mm
61-1014	24 Gauge Tip	1 3/8 in 35 mm	6 in 152 mm
61-1015	26 Gauge Tip	1 3/8 in 35 mm	6 in 152 mm
61-1016	Bellucci Tube Only		6 in 152 mm



61-1014

Suction Tubes (Ear, Middle Ear)

Rosen Suction Tube

CODE	DESCRIPTION	LENGTH	
61-1034	14 Gauge	2 in	50 mm
61-1035	15 Gauge	2 in	50 mm
61-1036	16 Gauge	2 in	50 mm
61-1037	17 Gauge	2 in	50 mm
61-1038	18 Gauge	2 in	50 mm
61-1039	19 Gauge	2 in	50 mm
61-1040	20 Gauge	2 in	50 mm
61-1041	22 Gauge	2 in	50 mm
61-1042	24 Gauge	2 in	50 mm
61-1043	26 Gauge	2 in	50 mm



61-1034

House Cut-Off Adapter

CODE	DESCRIPTION	LENGTH
61-1045	For Use with Rosen Suction	2 in 50 mm



Suction Tubes (Aspirating)

Jackson "Velvet Eye" Aspirating Tube

CODE	DESCRIPTION	DIAMETER	LENGTH
72-6046	12 French	4 mm	10 x 250 mm
74-6455	12 French	4 mm	20 x 500 mm
74-6457	"Velvet Eye"		40 x 600 mm

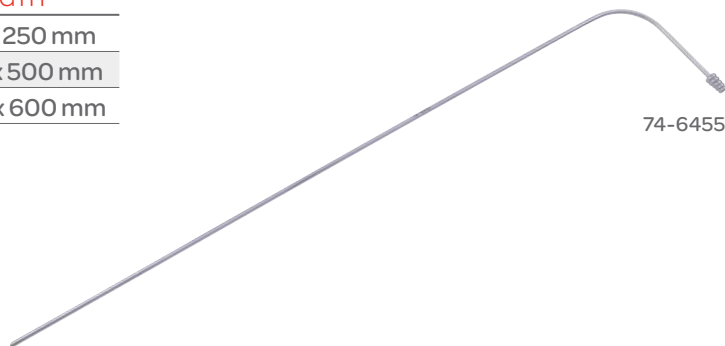

74-6455

Suction Tubes (Aspirating)

Jako Suction Tube

CODE	DESCRIPTION	HANDLE	LENGTH
74-5005	#00	5 French	9 in 230 mm
74-5006	#0	6 French	9 in 230 mm
74-5007	#1	7 French	9 in 230 mm



Suction Tubes (Laryngeal, Septum)

Kleinsasser Laryngeal Suction Tube

CODE	DESCRIPTION	LENGTH
74-5002	2.5 mm	9 in 230 mm



Gorney Septum Suction Tube

CODE	DESCRIPTION	LENGTH
63-7570	2 mm, with Stylet	8½ in 215 mm



Syringes (Ear)

Ear Syringe

CODE	DESCRIPTION
61-2001	Bulbous Tip
61-2005	Bulbous Tip
61-2006	Shield Tip
61-2004	Tapered Tip



Tracheal Tubes (Laryngectomy)

Martin Laryngectomy Tube

CODE	DESCRIPTION
72-6053	Size 8, Stainless Steel
72-6054	Size 10, Stainless Steel
72-6055	Size 12, Stainless Steel



72-6054

Trocars (Sinus & Nasal)

Van Alyea Antrum Trocar

CODE	DESCRIPTION
66-6047	Trocar Tip



Tip

Tuning Forks (Sinus & Nasal)

Tuning Fork

Aluminum Alloy for Both Air and Bone Conduction

CODE	DESCRIPTION
62-0709	C-64 with Weights
62-0710	C-128 with Weights
62-0711	C-256 with Weights
62-0712	C-512 without Weights
62-0713	C-1024 without Weights
62-0714	C-2048 without Weights
62-0715	C-4096 without Weights



Wire Guides (Middle Ear)

House Wire Strut Guide

CODE	DESCRIPTION	LENGTH
61-0364	Straight Shaft, 0.6 mm Tip with Notched End	6 ½ in 165 mm





Scan the code above
to learn more about
our General portfolio.

General Portfolio



symmetry surgical™

General



Applicators	GEN-2	Needles	GEN-172
Cannulas	GEN-3	Pin Wheels	GEN-173
Clamps	GEN-3	Pliers	GEN-173
Connectors	GEN-17	Probes	GEN-175
Curettes	GEN-18	Punches	GEN-176
Depressors	GEN-19	Raspatories	GEN-177
Dilators	GEN-19	Retractors	GEN-177
Dissectors	GEN-21	Rings	GEN-251
Elevators	GEN-21	Ring Cutters	GEN-251
Extractors	GEN-26	Rulers	GEN-252
Forceps	GEN-26	Scissors	GEN-252
Gonimeters	GEN-123	Scoops	GEN-308
Hammers	GEN-124	Spatulas	GEN-309
Hooks	GEN-124	Sponges	GEN-310
Knives	GEN-131	Stringers	GEN-310
Knife Handles	GEN-131	Suction Tubes	GEN-314
Markers	GEN-135	Trocars	GEN-328
Nail Nippers	GEN-135	Wire & Pin Cutters	GEN-328
Nail Splitters	GEN-138	Wire Twisters	GEN-329
Needle Holders	GEN-138		

Questions? Contact us at customerservice@symmetrysurgical.com
or learn more at symmetrysurgical.com



The Surgical Instrument Desk Reference

How to Use Our Catalog

The Symmetry Surgical catalog is designed with you in mind, to be your trusted resource for surgical instrumentation. We took great care in creating an easy-to-use, robust catalog and we think you'll be pleased with the design as you become more familiar with our broad portfolio.

Layout

The catalog is organized by surgical specialty *and* product function.

And we know that it is difficult to pick up an instrument and know what specialty it's listed in. To make your job easier, we've sorted the instruments in our portfolio by surgical function, too, including Energy, Laparoscopic, Retractors and Sterilization Solutions.

U.S. Customer Service

Your Symmetry Surgical Customer Service team wants to make ordering surgical instruments the easiest part of your day. We accept orders via phone, fax, email, our website, Global Healthcare Exchange (GHX) and through the mail.

PHONE

800.251.3000

(Available Monday through Friday, 8:30 AM–6:30 PM EST)

FAX

800.342.3272

EMAIL

customerservice@symmetrysurgical.com

ONLINE

symmetrysurgical.com

MAILING ADDRESS

Symmetry Surgical
Attn: Customer Service
3034 Owen Drive
Antioch, TN 37013

The Surgical Instrument Desk Reference

International Customer Service

PHONE

Symmetry Surgical Switzerland GmbH
+41 (0) 52 557 59 00
(Available Monday through Friday, 7:00-16:00 GMT)

Symmetry Surgical, Inc., USA
615.964.5672
(Available Monday through Friday, 8:30 AM–6:30 PM EST)

FAX

Symmetry Surgical Switzerland GmbH
+41 (0) 52 557 59 99

EMAIL

customerservice@symmetrysurgical.com
internationalorders@symmetrysurgical.com

ONLINE

symmetrysurgical.com

MAILING ADDRESS

Symmetry Surgical Switzerland GmbH
Bühlstrasse 27
CH-8200 Schaffhausen
Switzerland

Symmetry Surgical, Inc.
3034 Owen Drive
Antioch, TN 37013

INTERNATIONAL PAYMENT TERMS/RETURN GOODS POLICY/INSTRUMENT REPAIR & RESTORE PROGRAM/LITERATURE REQUESTS

Please contact your local distributor. Locate a local distributor contact, International Customer Service at +41 (0) 52 557 59 00 or 615.964.5672 (US).

Cardiovascular/Thoracic

Energy

Ear, Nose & Throat

General

Laparoscopic

Neurology

Obesity

OB/GYN

Ophthalmology

Orthopedics & Arthroscopy

Pediatrics

Rectal

Retractors

Spine

Urology

Sterilization Solutions

Alphabetical & Numeric Indexes

Applicators (Cotton)

Dean Cotton Applicator

CODE	DESCRIPTION	LENGTH
09-2485	Triangular End	6 in 152 mm

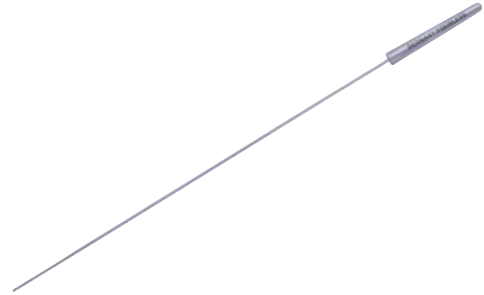

Farrell Cotton Applicator

CODE	DESCRIPTION	LENGTH
09-2116	Serrated End	6 ¼ in 159 mm
09-2118	Serrated End	7 in 178 mm

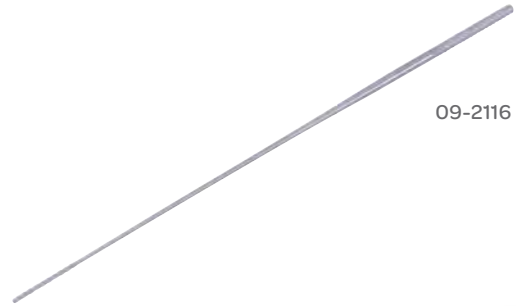

Farrell Cotton Applicator

CODE	DESCRIPTION	LENGTH
09-2166	Triangular End	6 ¼ in 159 mm



Uebe Cotton Applicator

CODE	DESCRIPTION	LENGTH
09-2168	Triangular End	7 in 178 mm



Cannulas

Suction/Irrigating Cannula

CODE	DESCRIPTION
57-3953	3.0 x 2.0 mm



Cannulas

Heparin I.M.A. Cannula

CODE	TIP WIDTH
54-5998	1.5 mm

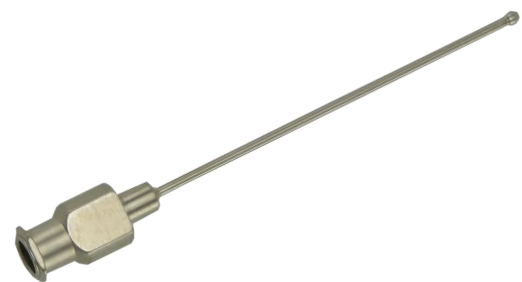

Clamps (Angiotribe)

Ferguson Clamp

CODE	DESCRIPTION	LENGTH
16-3816	Straight	6¼ in 159 mm
16-3819	Straight	8 in 203 mm
16-3916	Curved	6½ in 165 mm



16-3816

Clamps (Cystic Duct)

Borge Cystic Duct Clamp

CODE	DESCRIPTION	LENGTH
51-3004	4 French	8¼ in 210 mm
51-3006	6 French	8¼ in 210 mm



51-3006

Clamps (Intestinal)

Allen Intestinal

CODE	DESCRIPTION	LENGTH
50-1036	Straight, 1x2 Teeth	8 in 203 mm

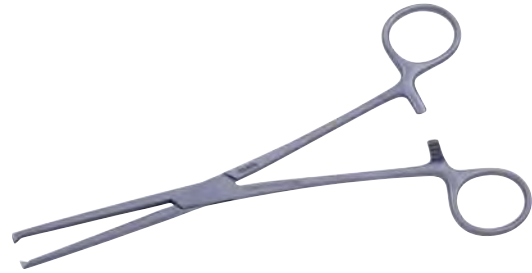

Block Potts Intestinal Clamp

CODE	DESCRIPTION	LENGTH
50-1780	Angled 40°	8½ in 216 mm



Clamps (Suction Tube)

Lore Suction Holding Clamp

CODE	DESCRIPTION	LENGTH
30-1280	Clamp	7 in 178 mm



Clamps (Tissue)

Pennington Clamp

Triangular Jaws

CODE	TIP WIDTH	LENGTH
19-4000	$\frac{7}{16}$ in 11 mm	6 in 152 mm
19-4001	$\frac{7}{16}$ in 11 mm	8 in 203 mm

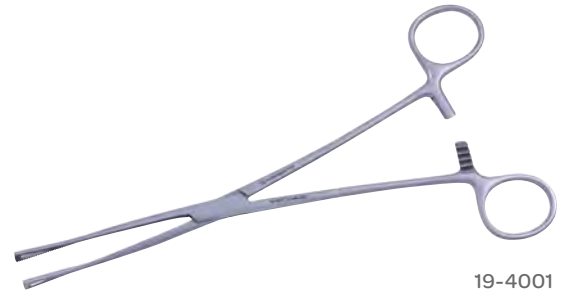

19-4001

Clamps (Biopsy Clamp)

Muscle Biopsy Forceps

CODE	JAW WIDTH	LENGTH
06-9100	15 mm	4½ in 114 mm



Clamps (Breast)

Adair Breast Clamp

CODE	DESCRIPTION	LENGTH
19-4004	Breast Clamp	7¾ in 197 mm

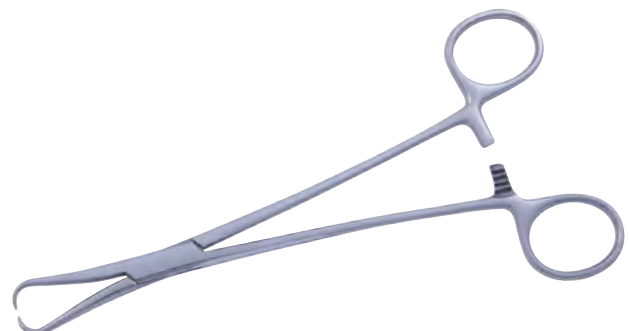

Clamps (Gastrointestinal)

Glassman Non-Crushing Gastrointestinal Clamp

CODE	DESCRIPTION	LENGTH
37-4018	Straight	9¼ in 235 mm
37-4017	Angled	9 in 229 mm

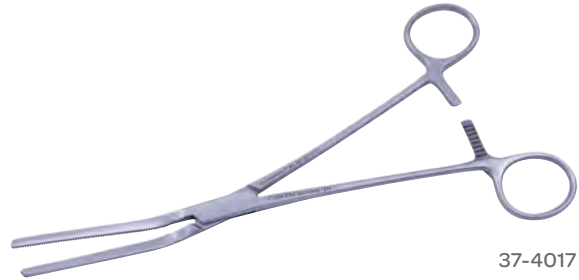

37-4017

Clamps (Hemostatic)

Classic® Delicate Clamp

CODE	DESCRIPTION	LENGTH
30-4493	Right Angle	5½ in 140 mm
30-4494	Right Angle	7 in 178 mm



30-4493

Gemini Classic® Delicate Clamp

CODE	DESCRIPTION	LENGTH
19-5579	Curved	5½ in 140 mm



Clamps (Hemostatic)

Gemini Hemostatic Clamp

CODE	DESCRIPTION	LENGTH	
19-5580	Curved	7 in	178 mm
19-5581	Curved	8 in	203 mm
19-5582	Curved	9 in	229 mm



19-5580

Mixer Right Angle Clamp

Longitudinal Serrations

CODE	DESCRIPTION	LENGTH	
19-8146	Angular, Cross-Serrated Tips	11 in	279 mm

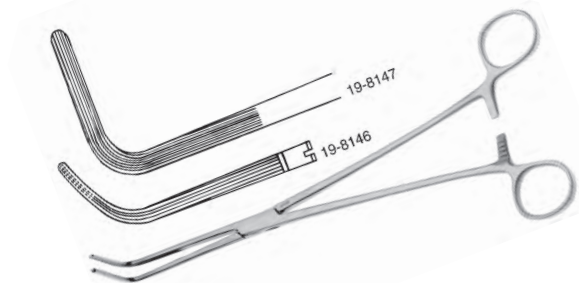

Vanderbilt Clamp

CODE	DESCRIPTION	LENGTH	
54-5001	Curved	8 $\frac{5}{8}$ in	219 mm
30-3018	Curved	8 $\frac{1}{2}$ in	216 mm



54-5001

Clamps (Hysterectomy)

Masterson Hysterectomy Forceps

2 x 3 Vascular Teeth, Jaw Length 1 $\frac{5}{8}$ in (41 mm)

CODE	DESCRIPTION	LENGTH	
37-1520	Straight	8 $\frac{1}{2}$ in	216 mm
37-1521	Curved	8 $\frac{1}{2}$ in	216 mm

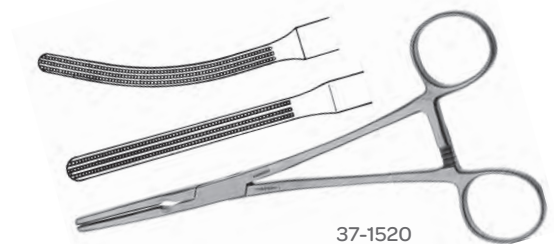

37-1520

Clamps (Hysterectomy)

Masterson Pelvic Clamp

Jaw Length $1\frac{3}{4}$ in (44 mm)

CODE	DESCRIPTION	LENGTH
37-1522	Straight	$10\frac{1}{2}$ in 267 mm
37-1523	Curved	$10\frac{1}{2}$ in 267 mm

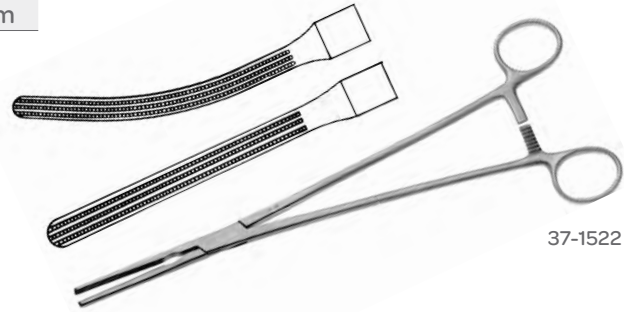

37-1522

Rogers Hysterectomy Forceps

Sarot-Style Shanks, 2 x 3 Vascular Teeth

CODE	DESCRIPTION	JAW LENGTH	LENGTH
37-1502	Straight	$1\frac{3}{4}$ in 44 mm	10 in 254 mm
37-1503	Curved	$1\frac{3}{4}$ in 44 mm	10 in 254 mm



37-1502
Tip

Rogers Hysterectomy Forceps

2 x 3 Vascular Teeth, Sarot Style Shanks

CODE	DESCRIPTION	JAW LENGTH	LENGTH
37-1501	Straight	$1\frac{1}{2}$ in 38 mm	$8\frac{1}{2}$ in 216 mm
37-1502	Straight	$1\frac{3}{4}$ in 44 mm	10 in 254 mm
37-1500	Curved	$1\frac{1}{2}$ in 38 mm	$8\frac{1}{2}$ in 216 mm
37-1503	Curved	$1\frac{3}{4}$ in 44 mm	10 in 254 mm



37-1500

Clamps (Intestinal)

Dennis Intestinal Clamp

CODE	JAW LENGTH	LENGTH
19-4060	2¼ in 57 mm	9½ in 241 mm

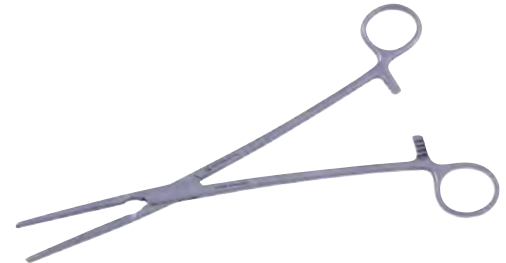

Doyen Vascular Toothed Intestinal Clamp

2x3 Vascular Teeth

CODE	DESCRIPTION	JAW LENGTH	LENGTH
37-1600	Straight	3¾ in 95 mm	9 in 229 mm
37-1601	Curved	3¾ in 95 mm	9 in 229 mm



37-1600

Masters Intestinal Clamp

CODE	JAW LENGTH	LENGTH
19-4062	4½ in 114 mm	9¼ in 235 mm
19-4061	6½ in 165 mm	10¾ in 270 mm



19-4062

Clamps (Kidney)

Herrick Kidney Clamp

CODE	DESCRIPTION	LENGTH
51-5735	Double-Angled Jaws with Longitudinal Serrations	9 in 229 mm



Clamps (Kidney)

Mayo-Guyon Kidney Clamp

CODE	JAW LENGTH	LENGTH
19-4018	3 $\frac{1}{16}$ in 85 mm	9 in 229 mm



Renal Artery Clamp

2 x 2 Vascular Teeth, Curved Shafts, Blades Calibrated at 5.0 mm Intervals

CODE	JAW LENGTH	LENGTH
37-1242	1 in 25 mm	10 $\frac{5}{8}$ in 270 mm



Wertheim-Cullen Kidney Clamp

CODE	DESCRIPTION	LENGTH
51-5775	Right-Angled Jaws with Longitudinal Serrations	8 $\frac{1}{2}$ in 216 mm



Clamps (Liver)

Masters-Schwartz Liver Clamp

CODE	JAW WIDTH	JAW LENGTH	LENGTH
19-4063	$\frac{1}{2}$ in 13 mm	7 $\frac{1}{2}$ in 191 mm	12 in 305 mm



Clamps (Pile)

Buie Pile Clamp

CODE	JAW LENGTH	LENGTH
19-5515	2 in 51 mm	8½ in 216 mm



Clamps (Pylorus)

Payr Pylorus Clamp

Without Pins

CODE	JAW LENGTH	LENGTH
50-5220	3 in 76 mm	8 in 203 mm
50-5235	5¾ in 146 mm	13¾ in 349 mm



Clamps (Thoracic)

Castaneda-Mixter Thoracic Clamp

CODE	DESCRIPTION	LENGTH
19-8150	Smooth Jaws	5¼ in 133 mm



Collier Modified Thoracic Clamp

CODE	DESCRIPTION	LENGTH
30-8065	Curved	10½ in 267 mm



Clamps (Thoracic)

Jones Thoracic Clamp

CODE	DESCRIPTION	LENGTH
19-8152	Curved	11¼ in 286 mm

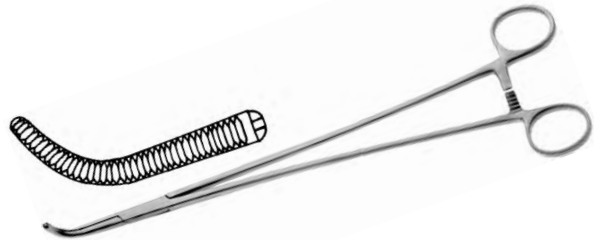

Mixer Thoracic Clamp

CODE	DESCRIPTION	LENGTH
19-8145	Curved, Cross-Serrations	9 in 229 mm
19-8147	Angular, Longitudinal Serrations, Standard Jaw	11 in 279 mm



19-8145

Clamps (Towel)

Backhaus Towel Clamp

CODE	DESCRIPTION	LENGTH
17-5508	Sharp Tips	3½ in 89 mm
17-5510	Sharp Tips	4½ in 114 mm
17-5513	Sharp Tips	5½ in 140 mm
32-5005	Bright Finish	5½ in 140 mm



17-5508

Edna Classic® Towel Clamp

CODE	DESCRIPTION	LENGTH
33-5016	Non-Perforating	4 in 102 mm
32-5015	Non-Perforating	5½ in 140 mm



33-5016

Clamps (Towel)

Jones Towel Clamp

CODE	DESCRIPTION	LENGTH
17-5008	Cross-Action	3½ in 89 mm
19-1016	Cross-Action	3½ in 89 mm



Lorna (Edna) Towel Clamp

CODE	DESCRIPTION	LENGTH
17-5715	Non-Perforating	4 in 102 mm
17-5714	Non-Perforating	5½ in 140 mm

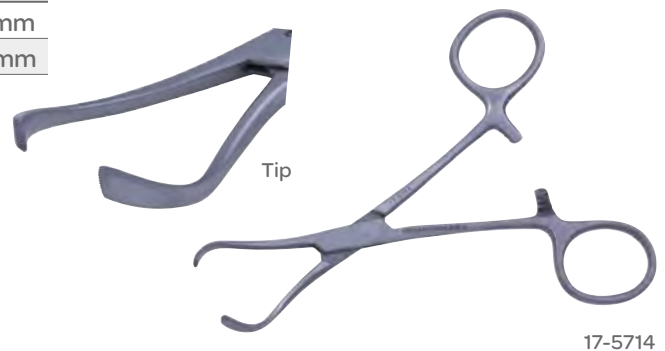

Peers Non-Perforating Towel Clip

CODE	DESCRIPTION	LENGTH
17-5800	Non-Perforating Jaws	5¾ in 146 mm
19-4146	Non-Perforating Jaws	5¾ in 146 mm

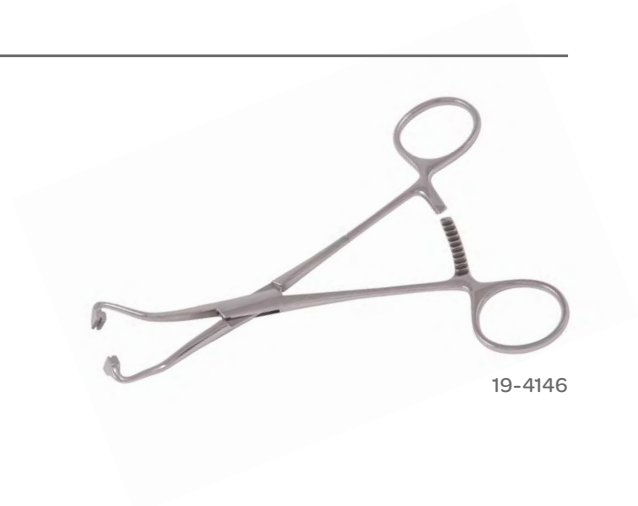

Clamps (Towel)

Roeder Towel Clamp

CODE	DESCRIPTION	LENGTH
19-4012	Ball Stops	5¼ in 133 mm



Towel Clamp

CODE	DESCRIPTION	LENGTH
17-5783	Jaws, Non-Perforating	5½ in 130 mm

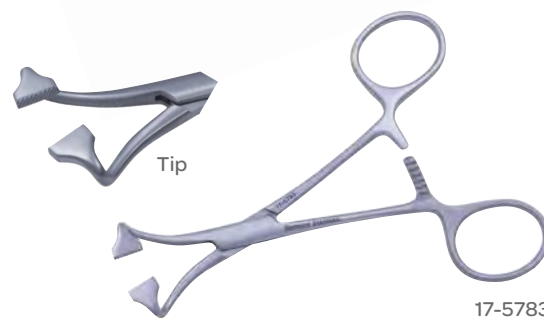

17-5783

Towel Clamp

CODE	DESCRIPTION	LENGTH
19-4137	Sterile, 6 Clamps to Package, 24 Packages to Case	2¾ in 70 mm
19-4141	Non-Sterile, Bulk Pack of 432	2¾ in 70 mm



Clamps (Tubing)

Presbyterian Hospital Tubing Clamp

Heavy Pattern

CODE	DESCRIPTION	LENGTH
17-7216	Smooth Jaws	6½ in 166 mm
17-7218	Smooth Jaws	7 in 178 mm
17-7220	Smooth Jaws	8 in 203 mm



17-7216

Clamps (Tubing)

Tubing Clamp

CODE	DESCRIPTION	LENGTH
32-3514	With Guard for Tubing 2.2 cm	8 in 203 mm



Tubing Clamp

Cross-Hatched Jaws, Tubing Jaw Length 1 in (25 mm), Tubing Jaw Opening with Closed Ratchets, $\frac{1}{8}$ in (3.0 mm)

CODE	JAW LENGTH	LENGTH
19-4133	1 $\frac{3}{4}$ in 44 mm	6 $\frac{1}{2}$ in 165 mm



Tubing Clamp

Should be Used with Tubing No Larger than $\frac{1}{4}$ in (6.0 mm) in Diameter

CODE	JAW LENGTH	LENGTH
19-8010	Length to Cuff 1 $\frac{5}{16}$ in (32 mm)	7 $\frac{1}{2}$ in 191 mm



U.S. Pattern Tube Occluding Forceps

U-Shaped Guard

CODE	DESCRIPTION	LENGTH
17-7280	Serrated Jaws	6 in 152 mm
17-7281	Serrated Jaws	6 $\frac{3}{4}$ in 171 mm
17-7282	Serrated Heavy Jaws	8 in 203 mm



17-7280

Clamps (Tubing)

Vorse Tubing Clamp

CODE	DESCRIPTION	LENGTH	
17-7283	Serrated Beveled Jaws	6 in	152 mm
17-7284	Serrated Beveled Jaws	7½ in	191 mm
17-7285	Serrated Heavy Jaws	8 in	203 mm



17-7285

Clamps (Vasectomy)

Vasectomy Fixation Ring Clamp

CODE	DESCRIPTION	LENGTH	
51-8005	15 Gauge Ring	6 in	152 mm



Vasectomy No Scalpel Hemostat Clamp

CODE	DESCRIPTION	LENGTH	
51-4001	Curved	6 in	152 mm

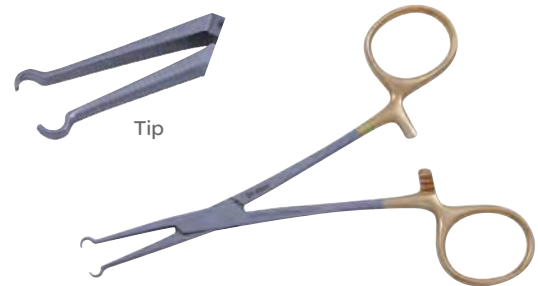

Vasectomy Clamp

CODE	DESCRIPTION	LENGTH	
51-8002	5x5 Blunt Teeth, Circular Jaws	6 in	152 mm



Clamps (Vessel)

Guyon-Mayo Vessel Clamp

CODE	DESCRIPTION	LENGTH
51-5615	Double-Curved Jaws	9 ¼ in 235 mm



Clamps (Wire)

Rubio Classic® Wire Holder Clamp

Tungsten Carbide Jaw Inserts

CODE	JAW WIDTH	LENGTH
36-2023	1.0 mm	5 in 127 mm



Connectors (Luer-Lock)

Connector

Luer Lock Connector

CODE	DESCRIPTION
09-7925	Olive End, Male Attachment for 3/16 in (21 mm) Tubing
09-7927	Olive End, Female Attachment for 3/16 in (21 mm) Tubing
09-7932	Cone End, Female Attachment Suitable for Inner 2.0–6.0 mm
09-7935	Cone End, Female Attachment for Inner 5.0–9.0 mm



09-7925

Stopcock

Luer Lock Connector

CODE	DESCRIPTION
09-7955	One-Way Male/Female
09-7965	Three-Way, 1 Male, 2 Female



09-7955

Curettes

Verucca Curette

Without Hole

CODE	TIP WIDTH	LENGTH
43-0483.0	1.0 mm	5 in 127 mm
43-0483.1	1.5 mm	5 in 127 mm
43-0483.2	2.0 mm	5 in 127 mm
43-0483	3.0 mm	5 in 127 mm
43-0485	4.0 mm	5 in 127 mm



43-0483

Curette Excavator

CODE	DESCRIPTION	LENGTH
43-0459	Non-Fenestrated Cup, 1.0 mm	5 in 127 mm
43-0461	Non-Fenestrated Cup, 1.5 mm	5 in 127 mm
43-0463	Non-Fenestrated Cup, 2.0 mm	5 in 127 mm
43-0465	Non-Fenestrated Cup, 2.5 mm	5 in 127 mm
43-0468	Fenestrated Cup, 1.0 mm	5 in 127 mm
43-0480	Fenestrated Cup, 2.0 mm	5 in 127 mm
43-0481	Fenestrated Cup, 2.5 mm	5 in 127 mm
43-0488	With Hole, 1.5 mm and 2.0 mm	5½ in 140 mm
43-0492	Double-Ended, 1.5 mm and 2.5 mm	5½ in 140 mm



43-0465

Fox Dermal Curette

Round

CODE	TIP WIDTH	LENGTH
43-1302	2.0 mm	5¾ in 146 mm
43-1303	3.0 mm	5¾ in 146 mm
43-1304	4.0 mm	5¾ in 146 mm
43-1305	5.0 mm	5¾ in 146 mm
43-1306	6.0 mm	5¾ in 146 mm



43-1302

Depressors

Wieder Tongue Depressors

Fenestrated-Serrated Blade

CODE	DESCRIPTION	BLADE WIDTH	
83-6505	Small Blade	1 $\frac{3}{16}$ in	30 mm
83-6506	Large Blade	1 $\frac{3}{8}$ in	35 mm



83-6506

Dilators (Common Bile Duct)



Bakes Common Duct Dilator Set

Malleable

CODE	DESCRIPTION	LENGTH	
25-4005	Set of Nine in Blue Vinyl Roll		
51-0601	1.0 mm	11 $\frac{3}{4}$ in	298 mm
51-0602	2.0 mm	11 $\frac{3}{4}$ in	298 mm
51-0603	3.0 mm	11 $\frac{3}{4}$ in	298 mm
51-0604	4.0 mm	11 $\frac{3}{4}$ in	298 mm
51-0605	5.0 mm	11 $\frac{3}{4}$ in	298 mm
51-0606	6.0 mm	11 $\frac{3}{4}$ in	298 mm
51-0607	7.0 mm	11 $\frac{3}{4}$ in	298 mm
51-0608	8.0 mm	11 $\frac{3}{4}$ in	298 mm
51-0609	9.0 mm	11 $\frac{3}{4}$ in	298 mm
51-0610	10 mm	11 $\frac{3}{4}$ in	298 mm
51-0611	11 mm	11 $\frac{3}{4}$ in	298 mm
51-0612	12 mm	11 $\frac{3}{4}$ in	298 mm
51-0613	13 mm	11 $\frac{3}{4}$ in	298 mm

Dilators (Vascular)

Garrett Vascular Dilators

Malleable Shaft

CODE	DESCRIPTION	LENGTH	
25-8035	Garrett Dilator Set	5½ in	140 mm
25-8036	1.0 mm	5½ in	140 mm
25-8037	1.5 mm	5½ in	140 mm
25-8038	2.0 mm	5½ in	140 mm
25-8039	2.5 mm	5½ in	140 mm
25-8040	3.0 mm	5½ in	140 mm
25-8041	3.5 mm	5½ in	140 mm
25-8042	4.0 mm	5½ in	140 mm
25-8043	4.5 mm	5½ in	140 mm
25-8044	5.0 mm	5½ in	140 mm



Dilators (Tracheal Dilators)

LaBorde Tracheal Dilator, Tri-Valve

CODE	DESCRIPTION	LENGTH	
25-4002	Jaw Width $\frac{3}{16}$ in (5.0 mm) Jaw Thickness $\frac{1}{4}$ in (6.0 mm) Total Spread $1\frac{15}{16}$ in (23.8 mm)	5¼ in	133 mm



Dilator (Tracheal Dilators)

Trousseau Tracheal Bi-Valve Dilator

CODE	DESCRIPTION	LENGTH	
25-4000	Jaw Width (Closed) $\frac{1}{4}$ in (6.0 mm) Jaw Thickness $\frac{3}{16}$ in (5.0 mm) Total Spread $1\frac{1}{2}$ in (38 mm)	5½ in	140 mm
25-5569	Jaw Width (Closed) $\frac{1}{8}$ in (3.0 mm) Jaw Thickness $\frac{1}{8}$ in (3.0 mm) Total Spread $1\frac{1}{4}$ in (32 mm)	5¼ in	133 mm



Dissectors

Cherry Secto® Dissectors

Dispenser box includes 96 packages of 5 each; 4 dispenser boxes to a case.

CODE	DESCRIPTION	DIAMETER
81-1002	Sterile, X-Ray Detectable	$\frac{3}{8}$ in 10 mm

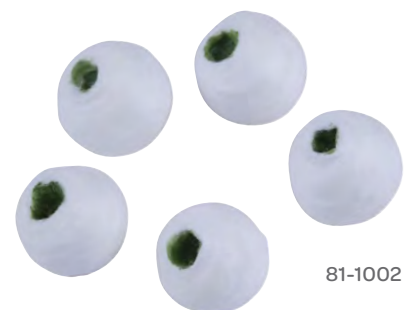

81-1002

Kittner Secto® Dissectors

Dispenser box includes 96 packages of 5 each; 4 dispenser boxes to a case.

CODE	DESCRIPTION	DIAMETER
81-1001	Sterile, X-Ray Detectable	$\frac{5}{16}$ in 8.0 mm

Peanut Secto® Dissectors

Dispenser box includes 96 packages of 5 each; 4 dispenser boxes to a case.

CODE	DESCRIPTION	DIAMETER
81-1000	Sterile, X-Ray Detectable	$\frac{3}{8}$ in 10 mm

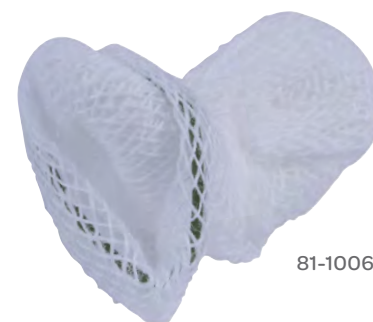

81-1006

Triangle Secto® Dissectors

Dispenser box includes 96 packages of 5 each; 4 dispenser boxes to a case.

CODE	DESCRIPTION	DIAMETER
81-1006	Sterile, X-Ray Detectable	$\frac{1}{2}$ in 13 mm

Elevators

Magnafree® Woodson Elevator & Spatula

CODE	DESCRIPTION	BLADE (W X D)	LENGTH
65-2423	Semi-Sharp, Titanium	$\frac{1}{8}$ x $\frac{1}{2}$ in 3.0 x 13 mm	10 in 254 mm



Malis® Elevator

Stainless Steel Shaft, Titanium Handle, Curved Tip

80-1537

CODE	DESCRIPTION	TIP WIDTH	WORKING DISTANCE	LENGTH
80-1537	Straight	3.5 mm		7 $\frac{1}{4}$ in 184 mm
80-1503	Bayonet	3.5 mm	4 in 102 mm	8 in 203 mm



Elevators

Rhoton® General Purpose Elevator

Titanium

80-1683



CODE	DESCRIPTION	TIP WIDTH	LENGTH
80-1683	Straight, Blunt, Small	1.2 mm	7½ in 191 mm
80-1684	Curved, Blunt, Large	2.2 mm	7½ in 191 mm

Woodson-Dural Separator & Packer



CODE	DESCRIPTION	BLADE (W X L)	LENGTH
65-1135	Double-Ended with Groove in Blade	⅛ x ½ in 3.0 x 13 mm	7 in 178 mm

Adson Periosteal Elevator

65-1033



CODE	DESCRIPTION	BLADE WIDTH	LENGTH
65-1030	#1, Chisel Edge Blade	⅝ in 8.0 mm	6½ in 165 mm
65-1031	#2, Curved, Blunt Edge	¼ in 6.0 mm	6½ in 165 mm
65-1032	#3, Curved, Semi-Sharp Edge	¼ in 6.0 mm	6½ in 165 mm
65-1033	#4, Straight, Semi-Sharp Edge	⅝ in 8.0 mm	6½ in 165 mm

Carroll Periosteal Elevator



CODE	DESCRIPTION	BLADE WIDTHS	LENGTH
65-2549	Double-Ended	⅛ in, ⅜ in 3.0 mm, 10 mm	5½ in 140 mm

Cushing Little Joker Periosteal Elevator

65-1047



CODE	DESCRIPTION	BLADE WIDTH	LENGTH
65-1047	"Little Joker" Hollow Handle	¼ in 6.0 mm	6 in 152 mm
65-1048	"Little Joker" Solid Handle	¼ in 6.0 mm	7½ in 191 mm

Elevators

Cushing Periosteal Elevator

Sharp



65-1075

CODE	DESCRIPTION	BLADE WIDTH	LENGTH
65-1050	Narrow, Round Handle	$\frac{1}{4}$ in 6.0 mm	$8\frac{1}{8}$ in 206 mm
65-1075	Wide, Rounded Edge Blade	$\frac{5}{8}$ in 16 mm	$7\frac{1}{4}$ in 184 mm
65-1076	Wide, Square Edge Blade	$\frac{5}{8}$ in 16 mm	$7\frac{1}{4}$ in 184 mm

Cushing Staphylorrhaphy Elevator



CODE	DESCRIPTION	BLADE WIDTH	LENGTH
65-1045	Round Handle	$\frac{7}{16}$ in 11 mm	$8\frac{1}{2}$ in 216 mm

Dorsey Dural Separator



CODE	BLADE WIDTH	BLADE LENGTH	LENGTH
65-1104	$\frac{3}{16}$ in 5.0 mm	$1\frac{1}{16}$ in 17 mm	6 in 152 mm

Frazier Dural Separator



CODE	DESCRIPTION	BLADE DEPTH	LENGTH
65-1100	Tapered Blade Width $\frac{1}{16}$ in to $\frac{1}{8}$ in (2.0 to 3.0 mm)	$\frac{1}{2}$ in 13 mm	$6\frac{1}{2}$ in 166 mm

Elevators

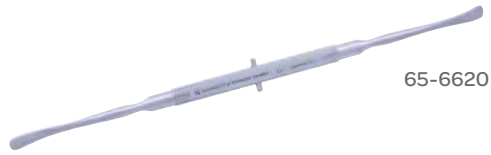

65-6620



55-7026

Freer Elevator

CODE	DESCRIPTION	WIDTH	LENGTH
65-6620	Double-Ended, Sharp and Blunt Ends	4.5 mm	7¼ in 184 mm
55-7027	Double-Ended, Sharp and Blunt Ends	4.5 mm	7½ in 191 mm
55-7026	Double-Ended, Sharp and Blunt Ends	6.5 mm	7½ in 191 mm



65-1101

Hoehn Dural Separator

CODE	DESCRIPTION	BLADE WIDTH	BLADE LENGTH	LENGTH
65-1101	#1, 90° Angle	⅛ in 3.0 mm	½ in 13 mm	6 in 152 mm
65-1102	#2, 45° Angle	⅛ in 3.0 mm	½ in 13 mm	6½ in 166 mm



65-1002

Hoehn Periosteal Elevator

CODE	DESCRIPTION	BLADE WIDTH	LENGTH
65-1001	#1	⅝ in 8.0 mm	7 in 178 mm
65-1003	#1	¾ in 20 mm	7½ in 191 mm
65-1002	#2	⅝ in 16 mm	7¼ in 184 mm



Iowa University Periosteal Elevator

CODE	BLADE WIDTH	LENGTH
65-1001	1⅛ in 17 mm	7¼ in 184 mm

Elevators



65-2510

Langenbeck Periosteal Elevator

CODE	BLADE WIDTH		LENGTH	
65-2510	¼ in	6.0 mm	7½ in	191 mm
65-2513	¼ in	6.0 mm	7½ in	191 mm
65-2511	⅜ in	10 mm	7½ in	191 mm
65-2512	½ in	13 mm	7½ in	191 mm
65-2514	1 in	25 mm	7½ in	191 mm



65-1115

Langenbeck Periosteal Elevator

CODE	DESCRIPTION	BLADE WIDTH		LENGTH	
65-1115	Narrow Blade	¼ in	6.0 mm	8¼ in	210 mm
65-1116	Wide Blade	⅛ in	17 mm	7½ in	191 mm



Love-Adson Periosteal Elevator

CODE	DESCRIPTION	BLADE WIDTH		LENGTH	
65-1110	Semi-Sharp	⅜ in	5.0 mm	6½ in	165 mm



Molt Periosteal Elevator #9

CODE	LENGTH
32-3420	7¼ in 184 mm

Elevators



65-1056

Periosteal Elevators

CODE	DESCRIPTION	TIP WIDTH	LENGTH
65-1056	#1, Sharp	$\frac{3}{16}$ in 5.0 mm	8 in 203 mm
65-1057	#2, Sharp	$\frac{1}{4}$ in 6.4 mm	8 in 203 mm
65-1058	#3, Sharp	$\frac{5}{16}$ in 8.0 mm	8 in 203 mm
65-1059	Sharp	$\frac{15}{32}$ in 12 mm	8 in 203 mm



65-1005

Presbyterian Hospital Staphylorrhaphy Elevator

Double-Ended, Semi-Sharp and Sharp Blades

CODE	DESCRIPTION	LENGTH
65-1005	Straight	7 in 178 mm
65-1006	Curved	7 in 178 mm

Extractors

Schaumburg Comedone Extractor

CODE	DESCRIPTION	LENGTH
43-3812	Small Loop Crimped	$5\frac{3}{4}$ in 148 mm



Forceps (Artery)

Sarot Artery Forceps

CODE	DESCRIPTION	LENGTH
30-8059	Slightly Curved, Jaw Length $2\frac{1}{4}$ in (57 mm)	9 in 229 mm
54-5002	Curved	$9\frac{1}{2}$ in 241 mm
54-4900	Curved	11 in 279 mm
54-4905	Curved	13 in 330 mm
32-3548	Curved	14 in 356 mm



30-8059

Forceps (Artery)

Adson Artery Forceps

CODE	DESCRIPTION	LENGTH
16-4019	Straight, Standard Pattern	7¼ in 184 mm
16-4021	Straight, Standard Pattern	8¼ in 210 mm
16-4118	Curved, Delicate Pattern	7⅛ in 181 mm
16-4119	Curved, Standard Pattern	7¼ in 184 mm
16-4121	Curved, Standard Pattern	8¼ in 210 mm



16-4019

Carmalt Artery Forceps

Jaws with Longitudinal Serrations, Cross-Serrated Tips

CODE	DESCRIPTION	LENGTH
16-3616	Straight	6½ in 165 mm
16-3716	Curved	6½ in 165 mm
16-3720	Curved	8⅞ in 225 mm
16-3723	Curved	9 in 229 mm



16-3616

Crafoord (Coller) Artery Forceps

Delicate Pattern

CODE	DESCRIPTION	LENGTH
16-1520	Curved	7¾ in 197 mm
16-1524	Curved	9 in 229 mm
16-1519	Strong Curve	7 in 178 mm
16-5123	Angled 90°	9½ in 241 mm



16-1520

Crile-Baby Artery Forceps

Delicate Pattern

CODE	DESCRIPTION	LENGTH
15-2414	Straight	5½ in 140 mm
15-2514	Curved	5¾ in 146 mm



15-2414

Forceps (Artery)

Harrington Artery Forceps

CODE	DESCRIPTION	LENGTH
16-3727	Curved	10 ³ / ₄ in 273 mm

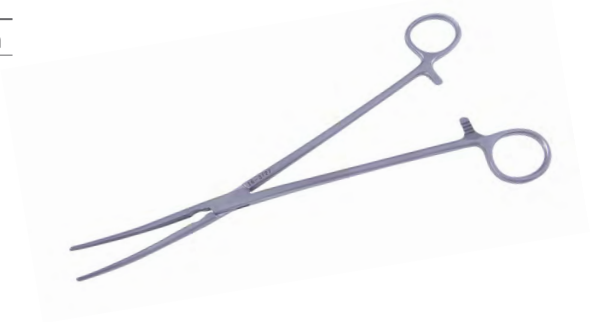

Heiss Artery Forceps

CODE	DESCRIPTION	LENGTH
16-5024	Straight, Delicate Pattern	9 ¹ / ₂ in 241 mm
16-5124	Curved, Delicate Pattern	9 ¹ / ₄ in 235 mm
16-5190	Right Angle 90° Delicate Pattern	8 in 203 mm
16-5194	Right Angle 90° Delicate Pattern	9 ¹ / ₂ in 241 mm



16-5024

Micro Hartmann Mosquito Artery Forceps

Very Delicate Pattern

CODE	DESCRIPTION	LENGTH
15-3009	Straight	3 ¹ / ₂ in 89 mm
15-3109	Curved	3 ¹ / ₂ in 89 mm



15-3009

Nissen Artery Forceps

CODE	DESCRIPTION	LENGTH
16-4025	Curved	7 ¹ / ₄ in 184 mm



Forceps (Artery)

Rochester-Mixter Artery Forceps

CODE	DESCRIPTION	LENGTH
17-0736	Angled 80°	6¼ in 159 mm
17-0740	Angled 80°	8 in 203 mm



17-0736

Rochester-Pean Baby Artery Forceps

CODE	DESCRIPTION	LENGTH
15-2914	Curved Delicate Pattern	5½ in 140 mm

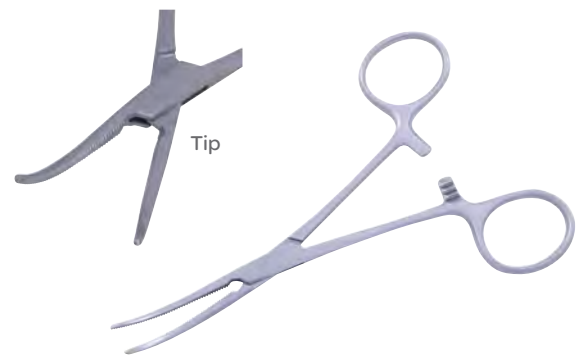

Wikstroem Artery Forceps

CODE	DESCRIPTION	LENGTH
17-0770	Angled 90°	8¼ in 210 mm

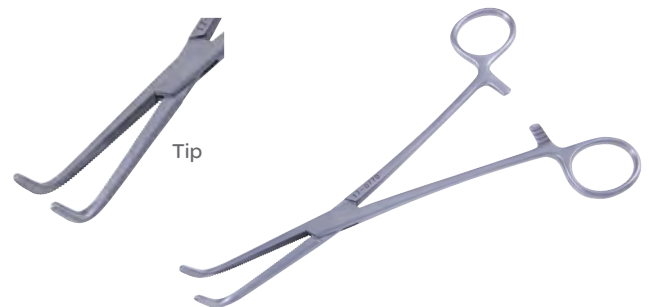

Coller-Crile Artery Forceps

Delicate

CODE	DESCRIPTION	LENGTH
15-7284	Straight	5½ in 140 mm
15-7286	Straight	6¼ in 159 mm
15-7384	Curved	5½ in 140 mm
15-7386	Curved	6¼ in 159 mm



15-7284

Forceps (Artery)

Crile Artery Forceps

CODE	DESCRIPTION	LENGTH
15-7214	Straight	5½ in 140 mm
15-7216	Straight	6¼ in 159 mm
15-7314	Curved	5½ in 140 mm
15-7316	Curved	6¼ in 159 mm



15-7214

Kelly Artery Forceps

CODE	DESCRIPTION	LENGTH
15-7014	Straight	5⅝ in 143 mm
15-7016	Straight	6¼ in 159 mm
15-7114	Curved	5½ in 140 mm
15-7116	Curved	6¼ in 159 mm

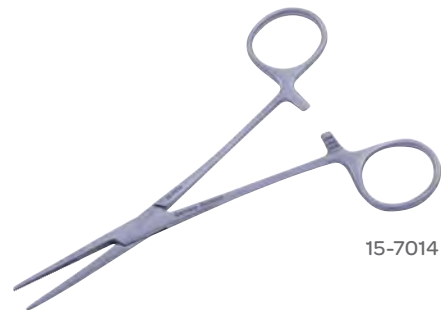

15-7014

Leriche Artery Forceps

CODE	DESCRIPTION	LENGTH
15-5615	Straight	6 in 152 mm
15-5715	Curved	6 in 152 mm



15-5615

Phaneuf Artery Forceps

CODE	DESCRIPTION	LENGTH
16-8021	Straight, 1x2 Teeth	8½ in 216 mm



Forceps (Artery & Intestinal)

Allen-Kocher Artery & Intestinal Forceps

Longitudinal Serrations

CODE	DESCRIPTION	LENGTH
15-8416	Straight, 1 x 2 Teeth	6 ¼ in 159 mm
15-8420	Straight, 1 x 2 Teeth	8 in 203 mm



15-8416

Bainbridge Artery & Intestinal Forceps

Standard Pattern

CODE	DESCRIPTION	LENGTH
15-8216	Straight	7 ½ in 191 mm
15-8316	Curved	7 ½ in 191 mm



15-8216

Forceps (Bayonet)

Adson Hypophyseal Forceps

Bayonet

CODE	CUP I.D.	WORKING DISTANCE	LENGTH
30-1000	¼ in 6.0 mm	4 ½ in 114 mm	9 in 229 mm



Cushing Bayonet Forceps

CODE	DESCRIPTION	LENGTH
07-2618	Serrated, Dissector End	7 ¼ in 184 mm
07-2619	Serrated, Dissector End	7 ½ in 191 mm
07-2718	1 x 2 Teeth, Dissector End	7 ¼ in 184 mm
07-2618-R	Round End	7 ¼ in 184 mm

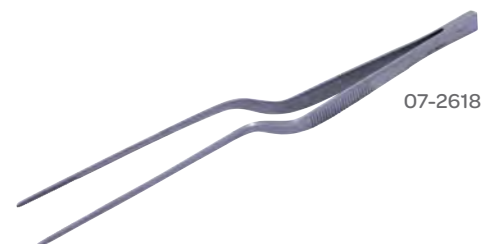

07-2618

Forceps (Bayonet)

D'errico Bayonet Forceps

Bayonet Shape

CODE	DESCRIPTION	LENGTH
58-1547	Serrated	8 ³ / ₄ in 222 mm
58-1548	1x2 Teeth	8 ³ / ₄ in 222 mm



Gruenwald Bayonet Forceps

CODE	DESCRIPTION	LENGTH
07-3019XL	Serrated	9 ¹ / ₂ in 241 mm
07-3020	Serrated Tips	7 ³ / ₄ in 197 mm

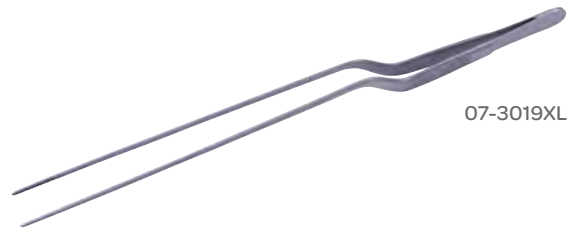

Jacobson Bayonet Forceps

Delicate Teeth

CODE	DESCRIPTION	LENGTH
58-1533	Sharp Tips	7 ¹ / ₄ in 184 mm
58-1532	Blunt Tips	7 ³ / ₈ in 187 mm



Lucae Ear Forceps

Bayonet Shape

CODE	DESCRIPTION	LENGTH
30-6898	2.0 mm Tip, Working Distance 2 ³ / ₄ in (70 mm)	5 ¹ / ₂ in 140 mm



Forceps (Bayonet)



Malis® Forceps

Bayonet, Titanium, Working Distance 3 ¾ in (95 mm)

CODE	DESCRIPTION	TIP WIDTH	WORKING DISTANCE	LENGTH
80-1509	Straight, Extra-Fine Tip	0.25 mm	3 ¾ in 95 mm	8 ¾ in 222 mm
80-1503	Straight, Fine Tip	0.5 mm	3 ¾ in 95 mm	8 ¾ in 222 mm
80-1502	Straight, Blunt Tip	0.75 mm	3 ¾ in 95 mm	8 ¾ in 222 mm
80-1505	Angled Up, Fine Tip	0.5 mm	3 ¾ in 95 mm	8 ½ in 216 mm
80-1507	Angled Down, Fine Tip	0.5 mm	3 ¾ in 95 mm	8 ½ in 216 mm
80-1504	90° Curved Up, Blunt Tip	0.75 mm	3 ¾ in 95 mm	8 ½ in 216 mm
80-1506	90° Curved Down, Blunt Tip	0.75 mm	3 ¾ in 95 mm	8 ½ in 216 mm

Yasargil Bayonet Forceps

CODE	DESCRIPTION	LENGTH
58-1544	Blunt Tips	9 ¼ in 230 mm
58-1546	Sharp Tips	9 ¼ in 230 mm



Adson Cushing Bayonet Forceps

CODE	DESCRIPTION	LENGTH
07-2620	Serrated Tips	7 ¾ in 197 mm



Forceps (Bayonet)

Hoehn Bayonet Forceps

CODE	DESCRIPTION	LENGTH
58-1550	Serrated, Gutsch Handle	7 ⁵ / ₈ in 194 mm

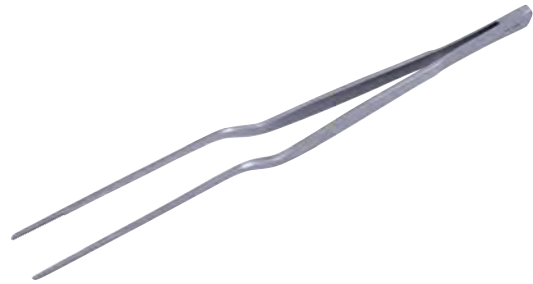

Hoehn Alligator Forceps

CODE	DESCRIPTION	LENGTH
30-1230	Tip Width 2.2 mm, 1x2 Teeth	5 ¹ / ₂ in 140 mm

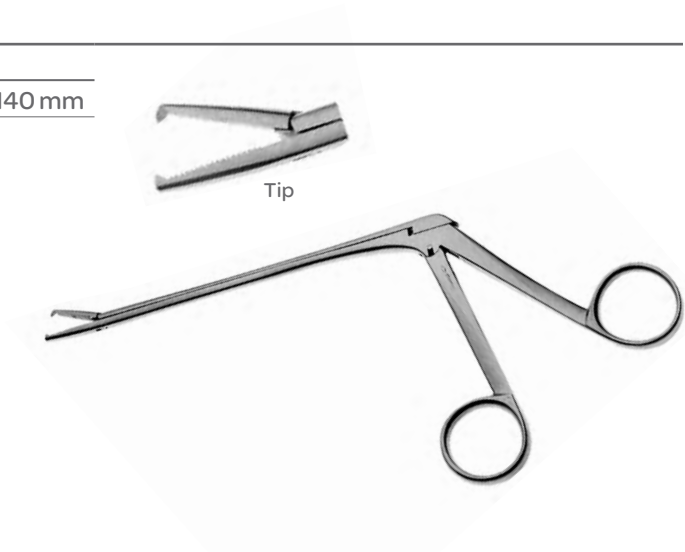

Forceps (Bipolar)

Adson Bipolar Forceps

Smooth Jaw

CODE	DESCRIPTION	LENGTH
08-0004	Non-insulated, 1.0 mm Tip	5 in 127 mm
08-0004I	Insulated, 1.0 mm Tip	4 ³ / ₄ in 121 mm



08-0004

Forceps (Bipolar)

Coaptation Bipolar Forceps

CODE	DESCRIPTION	LENGTH
08-0048	0.4 mm Tip	4½ in 114 mm

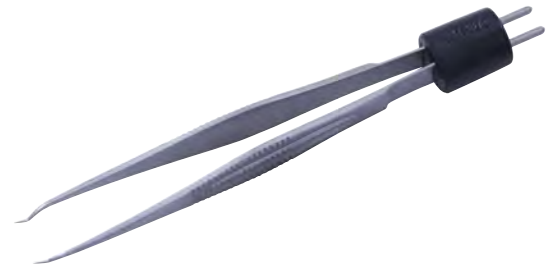

Coaptation Bipolar Forceps

CODE	DESCRIPTION	LENGTH
08-0008	Straight, 0.5 mm Tip	4¼ in 108 mm

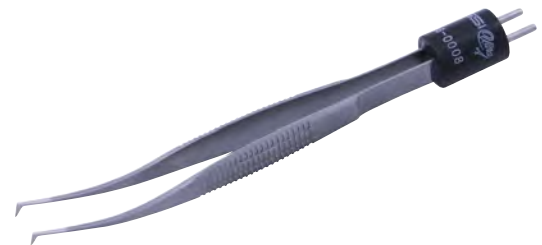

Gerald Bipolar Forceps

CODE	DESCRIPTION	LENGTH
08-0012	Straight, 1.0 mm Tip	7⅛ in 181 mm



Jewelers Bipolar Forceps

0.4 mm Tips

CODE	DESCRIPTION	LENGTH
08-0002	Curved	4⅜ in 111 mm
08-0005	Curved Arc	4 in 102 mm



Forceps (Bipolar)

Jewelers Titanium Bipolar Forceps

0.4 mm Tips, Titanium

CODE	DESCRIPTION	LENGTH
08-0054	Straight Tip, Titanium	3½ in 89 mm
08-0057	Straight Tip, Titanium	4¼ in 108 mm
08-0052	30° Angle Tip	3½ in 89 mm
08-0056	90° Angle Tip	4¼ in 108 mm
08-0053	Curved Tip	3½ in 89 mm

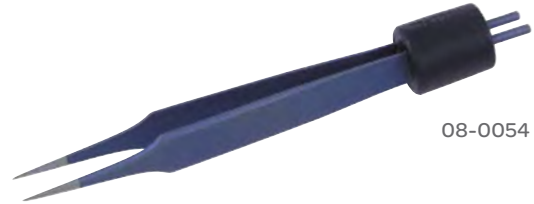

08-0054

McPherson Iris Bipolar Forceps

CODE	DESCRIPTION	LENGTH
08-0007	Angled, 0.25 mm Tip	3½ in 89 mm



Rhoton® Bayonet Bipolar Forceps

Straight, Titanium

CODE	DESCRIPTION	LENGTH
08-01221	0.5 mm Tip Insulated	9½ in 241 mm
08-0509	1.5 mm	



08-01221

Rhoton® Titanium Bipolar Forceps

CODE	DESCRIPTION	LENGTH
08-0058	0.5 mm Tips Round Handle	6 in 152 mm
08-0130	1.0 mm Tips	7 in 178 mm
08-0061	Curved 0.5 mm Tips Titanium, Round Handle	7⅛ in 181 mm



08-0061

Forceps (Bipolar)

Tenzel Bipolar Forceps

CODE	DESCRIPTION	LENGTH
08-0003	0.5 mm Tip, with Stop Curved Arc	4 in 102 mm



Bayonet Bipolar Titanium Forceps

Titanium

CODE	DESCRIPTION	TIP WIDTH	LENGTH
08-0020	Straight	1.0 mm	8½ in 216 mm
08-0062NS	Straight, Non-Stick	1.5 mm	8¾ in 222 mm
08-0101	Straight	1.5 mm	9 in 229 mm
08-0104	Angled Down	0.5 mm	8¾ in 222 mm
08-0105	Curved Up	0.75 mm	8¾ in 222 mm



Cushing Bayonet Bipolar Forceps

CODE	DESCRIPTION	LENGTH
08-0000I	0.7 mm Tips, Insulated	7½ in 191 mm
08-0026I	1.0 mm Tips, Insulated	7½ in 191 mm
08-0027I	1.0 mm Tips, Insulated	7½ in 191 mm
08-0026IG	1.0 mm Tips, Insulated, Irrigating	7½ in 191 mm
08-0000	0.7 mm Tips	7½ in 191 mm
08-0026	1.0 mm Tips	7½ in 191 mm
08-0027	1.5 mm Tips	7½ in 191 mm

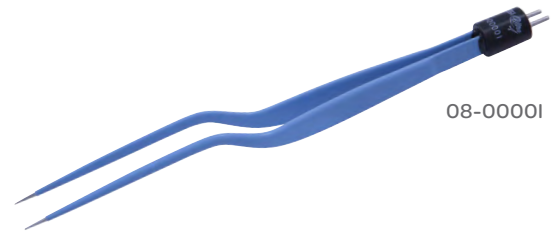

Forceps (Bipolar)

Gerald Bayonet Bipolar Forceps

1.0 mm Tips

CODE	DESCRIPTION	LENGTH
08-0013	Non-Insulated	7½ in 191 mm
08-0013IG	Insulated, Irrigating	7½ in 191 mm
08-0041	Irrigating	7½ in 191 mm

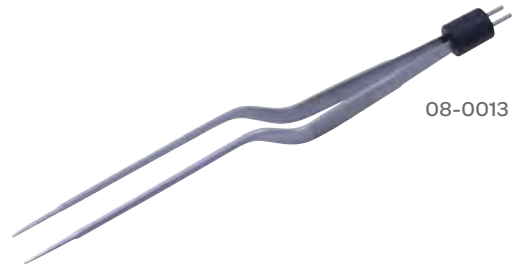

08-0013

Hardy™ Bayonet Bipolar Forceps

0.5 mm Tips without Stop

CODE	DESCRIPTION	LENGTH
08-0043	Non-Insulated	8½ in 216 mm
08-0043I	Insulated Flat Handle	8½ in 216 mm

Malis® Bayonet Bipolar Forceps, Non-Insulated

CODE	TIPS	DESCRIPTION	LENGTH
08-0089	1.5 mm		7¾ in 197 mm
08-0090	0.5 mm	Straight	5½ in 140 mm
08-0091	1.5 mm		7 in 178 mm
08-0100	0.5 mm	Straight, Titanium	8¾ in 222 mm
08-0108	0.75 mm	Straight, Titanium Flat Handle	8¾ in 222 mm



08-0090

Malis® Bayonet Bipolar Forceps, Insulated

CODE	TIPS	DESCRIPTION	LENGTH
08-0100IG	0.5 mm	Straight, Titanium Irrigating, Flat Handle	8¾ in 222 mm
08-0101IG	1.5 mm	Straight, Titanium Irrigating, Flat Handle	8¾ in 222 mm
08-0101I	1.5 mm	Straight, Titanium Flat Handle	8¾ in 222 mm
08-0100I	0.5 mm	Titanium, Flat Handle	8¾ in 222 mm
08-0075	0.25 mm	Titanium, Irrigating	8¾ in 222 mm
08-0143	0.5 mm	Straight, Irrigating, Flat Handle	7¾ in 197 mm
08-0149	1.5 mm	Insulated	8¾ in 222 mm



08-0143

Forceps (Bipolar)

Malis®-Jensen Bayonet Bipolar Forceps

CODE	DESCRIPTION	LENGTH
08-0223	0.25 mm Tip	7½ in 191 mm



McPherson Iris Bipolar Forceps

CODE	DESCRIPTION	LENGTH
08-00071	Angled 0.5 mm Tip, Insulated	3½ in 89 mm



Rhoton® Bayonet Bipolar Forceps, Non-Insulated

CODE	TIPS	DESCRIPTION	LENGTH
08-0303	0.5 mm	Straight	7⅛ in 181 mm
08-0304	0.7 mm	Straight	7⅛ in 181 mm
08-0311	1.0 mm	Straight	8⅝ in 219 mm
08-0312	1.5 mm	Straight	8⅝ in 219 mm
08-0301	2.0 mm	Straight	7⅛ in 181 mm
08-0308	0.3 mm	Straight, Round Handle	8⅝ in 219 mm
08-0309	0.5 mm	Straight, Round Handle	8⅝ in 219 mm
08-0310	0.7 mm	Straight, Round Handle	8⅝ in 219 mm
08-0319	0.7 mm	Straight, Round Handle	10 in 254 mm
08-0300	1.0 mm	Straight, Round Handle	7⅛ in 181 mm
08-0306	1.5 mm	Straight, Round Handle	7⅛ in 181 mm
08-0307	2.0 mm	Straight, Round Handle	7⅛ in 181 mm
08-0313	2.0 mm	Straight, Round Handle	8⅝ in 219 mm



Forceps (Bipolar)

Rhoton® Bayonet Bipolar Forceps, Insulated

CODE	TIPS	DESCRIPTION	LENGTH
08-0028I	0.25 mm	Insulated	7 ³ / ₄ in 197 mm
08-0128	1.5 mm	Titanium	9 ¹ / ₂ in 241 mm
08-0301I	2.0 mm	Round Handle	7 ¹ / ₈ in 181 mm
08-0306I	1.5 mm	Round Handle	7 ³ / ₄ in 197 mm
08-0311I	1.0 mm	Round Handle	8 ⁵ / ₈ in 219 mm
08-0312I	1.5 mm	Round Handle	8 ⁵ / ₈ in 219 mm
08-0313I	2.0 mm	Round Handle	8 ⁵ / ₈ in 219 mm
08-0313IG	2.0 mm	Irrigating, Round Handle	8 ⁵ / ₈ in 219 mm



Rhoton® Titanium Bayonet Bipolar Forceps

Round Handle

CODE	DESCRIPTION	LENGTH
08-0120	0.5 mm Tips	8 ¹ / ₂ in 216 mm
08-0122	0.5 mm Tips	9 ¹ / ₂ in 241 mm
08-0123	1.0 mm Tip	9 ¹ / ₂ in 241 mm



Scoville-Greenwood Bayonet Bipolar Forceps

1.5 mm Tips

CODE	DESCRIPTION	LENGTH
08-0092	Non-Insulated	7 in 178 mm
08-0030	Non-Insulated	7 ³ / ₄ in 197 mm
08-0030I	Insulated	7 ³ / ₄ in 197 mm
08-0030IG	Irrigating, Insulated	7 ³ / ₄ in 197 mm



Yasargil Bayonet Bipolar Forceps, Non-Insulated

CODE	TIPS	DESCRIPTION	LENGTH
08-0015	0.7 mm	Flat Handle	6 ³ / ₄ in 171 mm
08-0016	1.0 mm	Flat Handle	6 ³ / ₄ in 171 mm
08-0017	0.5 mm		7 ¹ / ₈ in 181 mm
08-0018	0.7 mm		7 ¹ / ₈ in 181 mm
08-0019	1.0 mm	Flat Handle	7 ¹ / ₈ in 181 mm
08-0022	0.7 mm		7 ¹ / ₈ in 181 mm
08-0023	1.0 mm	Flat Handle	7 ¹ / ₈ in 181 mm
08-0024	1.3 mm	Flat Handle	7 ¹ / ₈ in 181 mm
08-0025	1.3 mm	Flat Handle	7 ¹ / ₈ in 181 mm



Forceps (Bipolar)

Yasargil Bayonet Bipolar Forceps, Insulated

CODE	TIPS	DESCRIPTION	LENGTH
08-0022I	0.7 mm	Irrigating	7 1/8 in 181 mm
08-0023IG	1.0 mm	Insulated, Irrigating, Flat Handle	7 1/8 in 181 mm
08-0025I	1.3 mm	Insulated, Flat Handle	7 1/8 in 181 mm

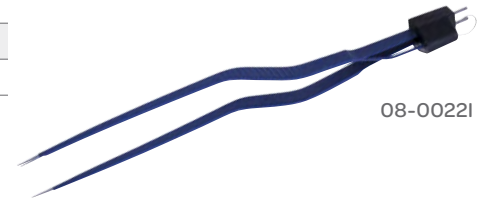

08-0022I

Forceps (Bronchus Clamp)

Sarot Bronchus Clamp

CODE	DESCRIPTION	LENGTH
54-5751	Curved Left	9 1/4 in 235 mm
54-5752	Curved Right	9 1/4 in 235 mm



54-5752

Forceps (Catheter)

Magill Catheter Forceps

CODE	DESCRIPTION	LENGTH
45-7501	Infant	6 1/4 in 159 mm
45-7502	Child	7 1/2 in 191 mm
45-7503	Adult	9 1/2 in 241 mm



45-7501

Magill Endotracheal Catheter Introducing Forceps

CODE	DESCRIPTION	LENGTH
30-4340	Adult	9 1/2 in 241 mm

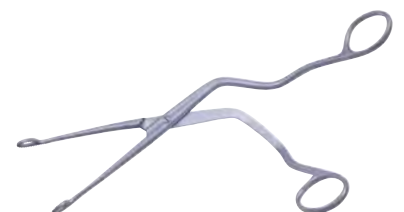

Forceps (Combination with Needle Holder)

Combination Needle Holder & Forceps

CODE	LENGTH
30-8002	5½ in 140 mm



Forceps (Cystic Duct)

Malik Cystic Duct Forceps

CODE	LENGTH
51-3369	8½ in 216 mm

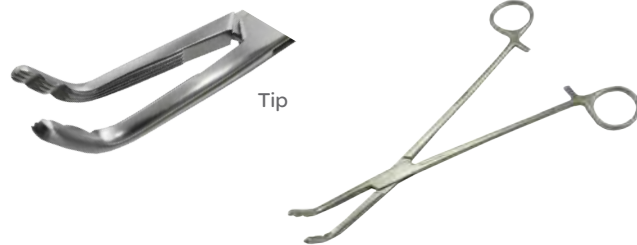

Forceps (Dissecting)

Mixer-Crafoord Dissecting Forceps

CODE	DESCRIPTION	LENGTH
17-0775	Angled 90°	10 in 254 mm

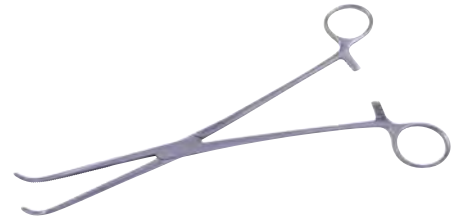

Forceps (Dissecting and Ligature)

Overholt Dissecting & Ligature Forceps

CODE	DESCRIPTION	LENGTH
16-6519	Curved	8¼ in 210 mm



Forceps (Dissecting Artery)

Rumel Dissecting Artery Forceps

CODE	DESCRIPTION	LENGTH
16-6761	Curved	9 in 229 mm



Forceps (Dressing)

Adson Dressing Forceps

Standard Pattern

CODE	DESCRIPTION	LENGTH
06-2012	Serrated	4 ¾ in 121 mm
06-2014	Cross-Serrated Tips	4 ¾ in 121 mm
06-2112	1x2 Teeth	4 ¾ in 121 mm

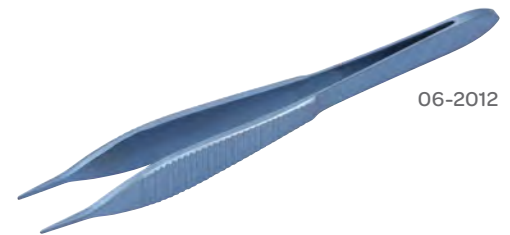

Adson Bayonet Dressing Forceps

CODE	WORKING DISTANCE	LENGTH
30-1191	3 ½ in 92 mm	7 ½ in 191 mm



Adson Dressing Forceps

CODE	DESCRIPTION	LENGTH
32-500	Tungsten Carbide Inserts	4 ¾ in 121 mm
30-1185	1.2 mm Tip, Standard Pattern	5 in 127 mm
30-1190	2.0 mm Tip, Standard Pattern	7 in 178 mm
06-2216	XL Tip	4 ¾ in 121 mm
32-501	Tungsten Carbide Inserts	6 in 152 mm
30-4214	0.8 mm Tip, Delicate Pattern	5 in 127 mm



Forceps (Dressing)

Bozeman Dressing Forceps

CODE	DESCRIPTION	LENGTH
19-8126	S-Shape	10 $\frac{3}{4}$ in 273 mm



Children's Hospital Classic® Delicate Dressing Forceps

CODE	DESCRIPTION	LENGTH
30-4208	1.4 mm Tip, Narrow Serrated Tips, Dissecting End	5 $\frac{3}{4}$ in 146 mm



Cosgrove Type Dressing Forceps

CODE	DESCRIPTION	LENGTH
32-518	1.0 mm Tip, Tungsten Carbide Inserts	8 in 203 mm



Cushing Bayonet Dressing Forceps

Serrated, Bayonet, Dissecting Handle

CODE	TIP WIDTH	WORKING DISTANCE	LENGTH
30-1155	1.8 mm	3 in 76 mm	7 $\frac{1}{4}$ in 184 mm
30-1156	1.4 mm	3 in 76 mm	7 $\frac{3}{4}$ in 197 mm



30-1155

Forceps (Dressing)

Cushing Dressing Forceps

CODE	TIP WIDTH	WORKING DISTANCE	LENGTH
30-1203	2.1 mm	3¼ in 83 mm	8¾ in 222 mm



30-1203

Cushing Dressing Forceps

CODE	DESCRIPTION	LENGTH
30-1152	1.3 mm Tip, Serrated Handle	7 in 178 mm
30-1150	1.5 mm Tip, Serrated Handle	7 in 178 mm
30-1154	1.8 mm Tip, Serrated	7¾ in 197 mm

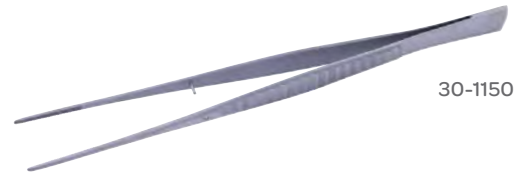

30-1150

Dressing Forceps

Fine Serrated Handle

CODE	DESCRIPTION	LENGTH
06-0011	Standard Pattern	4½ in 114 mm
06-0013	Standard Pattern	5 in 127 mm
06-0014	Standard Pattern	5½ in 140 mm
06-0015	Standard Pattern	6 in 152 mm
06-0018	Standard Pattern	7 in 178 mm
06-0020	Standard Pattern	8 in 203 mm
06-0025	Standard Pattern	10 in 254 mm
06-0030	Standard Pattern	12 in 305 mm
06-0035	Standard Pattern	14 in 356 mm
06-0040	Standard Pattern	16 in 405 mm
06-0045	Standard Pattern	18 in 458 mm
06-0020E	Serrated, Ebonized	8 in 203 mm
06-0025E	Serrated, Ebonized	10 in 254 mm



06-0011

Forceps (Dressing)

Dressing Forceps

Serrated

CODE	TIP WIDTH	LENGTH	
30-4138	3.0 mm	10 in	254 mm
30-4139	3.4 mm	12 in	305 mm



Ewald-Hudson Dressing Forceps

CODE	DESCRIPTION	LENGTH	
30-4215	1.7 mm Tip, Serrated	5 in	127 mm
06-2001	Serrated	4 3/4 in	121 mm



Eye Dressing Forceps

CODE	DESCRIPTION	TIP WIDTH	LENGTH	
30-6520	Straight	1.0 mm	4 in	102 mm
30-6524	Curved	1.0 mm	4 in	102 mm



Gerald Bayonet Dressing Forceps

Serrated

CODE	TIP WIDTH	WORKING DISTANCE	LENGTH	
30-1216	1.3 mm	3 1/2 in 89 mm	7 1/2 in	191 mm



Forceps (Dressing)

Gerald Dressing Forceps

CODE	DESCRIPTION	LENGTH
30-1214	Straight Tip, Width 1.1 mm Serrated	7 in 178 mm



Gillies Forceps

CODE	DESCRIPTION	LENGTH
06-4088	1.0 mm Tip, Cross Serrations	10 in 254 mm



Gruenwald Bayonet Dressing Forceps

Bayonet

CODE	DESCRIPTION	LENGTH
07-3016	Serrated	6 ¼ in 159 mm
07-3019	Serrated	8 in 203 mm
07-3119	1x2 Teeth	8 in 203 mm

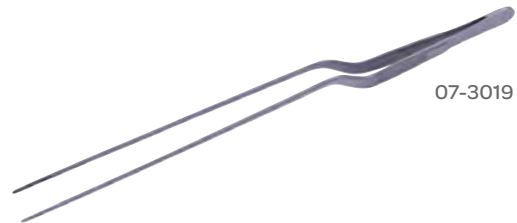

Hardy™ Dressing Forceps

Bayonet

CODE	TIP WIDTH	WORKING DISTANCE	LENGTH
30-1205	1.0 mm	4 ½ in 114 mm	8 ¼ in 210 mm



Forceps (Dressing)

Hoehn Bayonet Dressing Forceps

Serrated, Gutsch Handle

CODE	DESCRIPTION	LENGTH
30-1165	Tip Width 2.0 mm Working Distance 3 in (76 mm)	7 ³ / ₄ in 197 mm

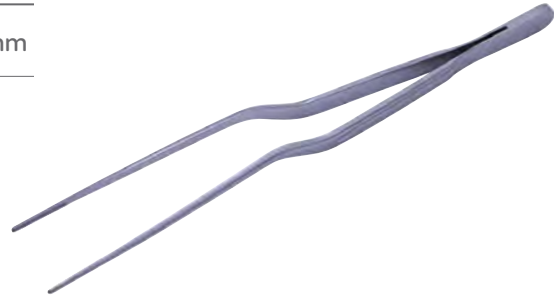

Jansen Bayonet Dressing Forceps

CODE	DESCRIPTION	LENGTH
30-1160	Serrated Tip, Tip Width 1.8 mm, Working Distance 4 ³ / ₈ in (121 mm)	8 ¹ / ₂ in 216 mm
30-6995	Serrated Tip, Tip Width 2.0 mm, Working Distance 3 ¹ / ₈ in (80 mm)	6 ¹ / ₂ in 165 mm



30-1160

Lucae Bayonet Dressing Forceps

CODE	DESCRIPTION	LENGTH
07-3014	Serrated	5 ³ / ₄ in 146 mm
07-3114	1 x 2 Teeth	5 ³ / ₄ in 146 mm



07-3014

Forceps (Dressing)

Potts-Smith Dressing Forceps

CODE	DESCRIPTION	LENGTH
30-8020	1.4 mm Tip	7¼ in 184 mm
30-8022	1.5 mm Tip, Serrated	9½ in 241 mm
30-8122	1.6 mm Tip, Serrated	12 in 305 mm
06-4638	Serrated	14 in 356 mm



06-4638

Rhoton® Dressing Forceps

CODE	DESCRIPTION	LENGTH
80-1732	1.8 mm Tip Serrated, Titanium	7 in 178 mm



Semken Dressing Forceps

Serrated

CODE	DESCRIPTION	LENGTH
06-3012	Straight	5 in 127 mm
06-3112	Straight	5 in 127 mm
06-3022	Curved	5 in 127 mm
30-1180	Tip Width 1.3 mm	5 in 127 mm



06-3012

Forceps (Gall Stone)

Blake Gall Stone Forceps

CODE	DESCRIPTION	LENGTH
51-4020	Straight	8 in 203 mm

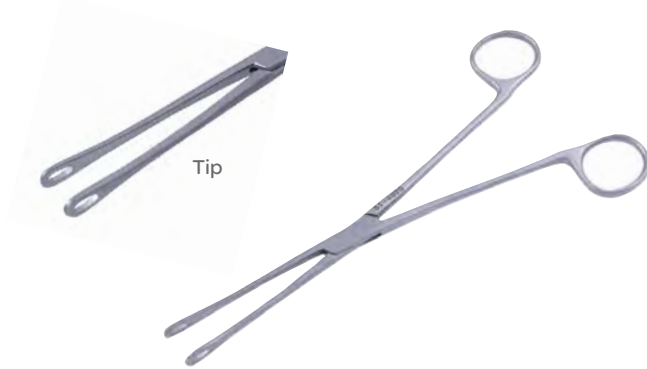

Desjardins Gall Stone Forceps

Curved Jaws with Atraumatic Serrations 2½ in (64 mm)

CODE	DESCRIPTION	LENGTH
51-4301	Small Jaws	9 in 229 mm
51-4302	Large Jaws	9¼ in 235 mm

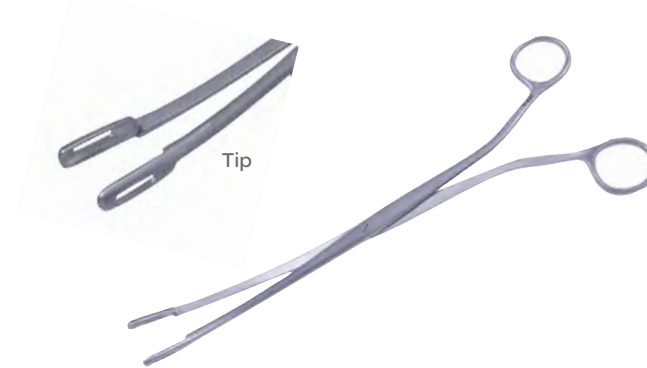

Forceps (Gallbladder)

Moynihan Gallbladder Duct Forceps

CODE	DESCRIPTION	LENGTH
30-4295	Curved	8½ in 216 mm

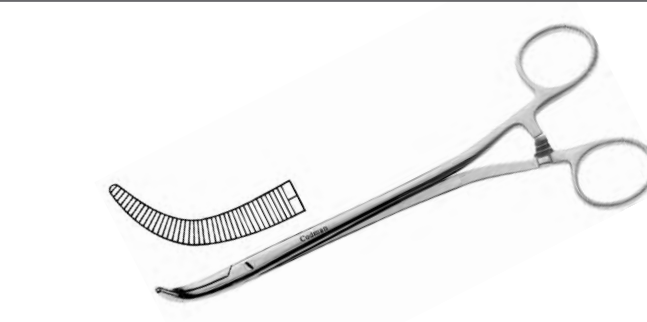

Forceps (Gastrointestinal)

Glassman Gastrointestinal Forceps

4 ½ in (102 mm) Jaws with 2 x 2 Atraumatic Traumatic Serrations, Sturdy Pattern

CODE	DESCRIPTION	LENGTH
50-3028	Straight	11 in 279 mm
50-3128	Angled	11 in 279 mm



Mayo-Robson Gastrointestinal Forceps

CODE	DESCRIPTION	LENGTH
50-1825	Straight	10 in 254 mm



Forceps (Goiter)

Lahey Goiter Traction Forceps

CODE	DESCRIPTION	LENGTH
73-7233	3 x 3 Sharp Teeth	6 in 152 mm



Lahey Goiter Tenaculum

CODE	DESCRIPTION	LENGTH
30-4088	3 x 3 Sharp Teeth	6 ¼ in 159 mm



Forceps (Hemostatic)

Adson Hemostatic Forceps

Delicate Pattern, 1 x 2 Teeth

CODE	DESCRIPTION	LENGTH
16-4218	Straight	7 $\frac{1}{8}$ in 181 mm
16-4318	Curved	7 $\frac{1}{8}$ in 181 mm



16-4318

Adson-Baby Hemostatic Forceps

CODE	DESCRIPTION	LENGTH
17-0519	Curved, Very Delicate	7 $\frac{1}{2}$ in 191 mm



Adson Hemostatic Forceps

CODE	DESCRIPTION	LENGTH
30-1010	Straight	7 $\frac{1}{4}$ in 184 mm
30-1011	Curved	7 $\frac{1}{4}$ in 184 mm



30-1010

Skillman Forceps

CODE	DESCRIPTION	LENGTH
30-4009	Curved	5 in 127 mm



Forceps (Hemostatic)

Crile Classic® Delicate Hemostatic Forceps

CODE	DESCRIPTION	LENGTH
30-4467	Straight	5½ in 140 mm
30-4468	Curved	5½ in 140 mm



Crile Classic® Hemostatic Forceps

CODE	DESCRIPTION	LENGTH
32-4030	Straight, Standard Line	5½ in 140 mm
32-4040	Straight, Standard Line	6¼ in 159 mm
32-4031	Curved, Standard Line	5½ in 140 mm
32-4041	Curved, Standard Line	6¼ in 159 mm
33-4030	Straight, Bright Finish	5½ in 140 mm
33-4041	Curved, Bright Finish	6¼ in 159 mm
34-4040	Straight, Low-Glare Finish	6¼ in 159 mm
34-4041	Curved, Low-Glare Finish	6¼ in 159 mm



Adson Classic® Hemostatic Forceps

CODE	DESCRIPTION	LENGTH
30-4464	Curved	7¼ in 184 mm

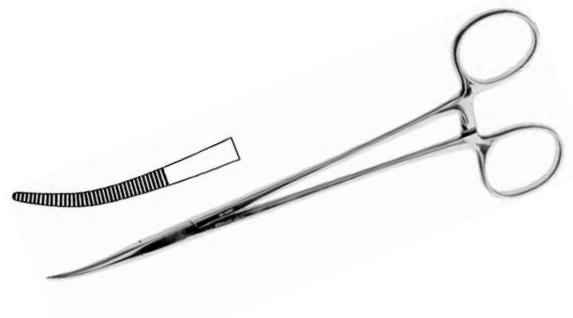

Forceps (Hemostatic)

Kocher Delicate Classic® Forceps

CODE	DESCRIPTION	LENGTH
30-4490	Straight, 1 x 2 Teeth	5½ in 140 mm
30-4491	Curved	5½ in 140 mm



30-4490

Gemini Hemostatic Clamp

CODE	DESCRIPTION	LENGTH
19-5583	Curved	11 in 279 mm

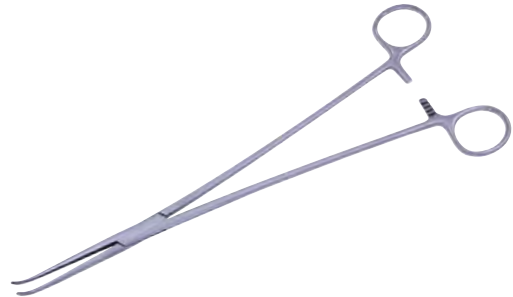

Halsted Hemostatic Forceps

CODE	DESCRIPTION	LENGTH
30-4105	Straight, 1 x 2 Teeth	5 in 127 mm
30-4038	Straight, without Teeth	7 in 178 mm
30-4106	Curved, 1 x 2 Teeth	5 in 127 mm
30-4039	Curved, without Teeth	7 in 178 mm



30-4105

Kelly Classic® Hemostatic Forceps

CODE	DESCRIPTION	LENGTH
32-4020	Straight, Standard Line	5½ in 140 mm
33-4020	Straight, Bright Finish	5½ in 140 mm
32-4021	Curved, Standard Line	5½ in 140 mm
34-4021	Curved, Low-Glare Finish	5½ in 140 mm



33-4020

Forceps (Hemostatic)

Kelly Placenta Forceps

CODE	DESCRIPTION	LENGTH
30-5695	Serrated Jaw	12 in 305 mm

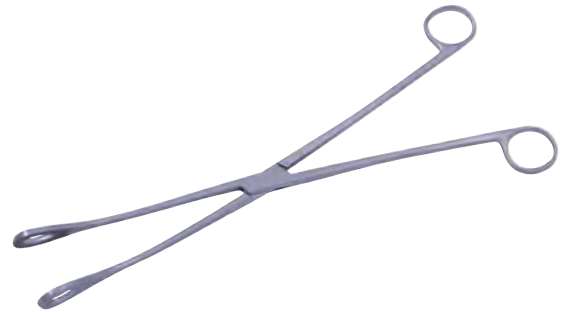

Kocher Hemostatic Forceps

CODE	DESCRIPTION	LENGTH
16-1214	Straight, 1 x 2 Teeth	5 5/8 in 143 mm
16-1314	Curved, 1 x 2 Teeth	5 5/8 in 143 mm



Kocher-Baby Forceps

CODE	DESCRIPTION	LENGTH
15-2014	Straight, Delicate Pattern 1 x 2 Teeth	5 1/2 in 140 mm



Kocher Hemostatic Forceps

CODE	DESCRIPTION	LENGTH
32-4100	Straight, 1 x 2 Teeth Bright Finish	5 1/2 in 140 mm



Forceps (Hemostatic)

Kocher Intestinal Forceps

CODE	DESCRIPTION	LENGTH	
30-4300	Straight, Longitudinal Serrations	11 in	279 mm



Mosquito Classic® Delicate Hemostatic Forceps

CODE	DESCRIPTION	LENGTH	
30-4471	Straight	4 in	102 mm
30-4473	Straight	5 in	127 mm
30-4472	Curved	4 in	102 mm
30-4474	Curved	5 in	127 mm
30-4470	Curved	6 in	152 mm



30-4470

Pean Classic® Delicate Hemostatic Forceps

CODE	DESCRIPTION	LENGTH	
30-4462	Curved	5½ in	140 mm



Forceps (Hemostatic)

Providence Hospital Hemostatic Forceps

CODE	DESCRIPTION	LENGTH
32-4011	Curved, Bright Finish	5½ in 140 mm



Rankin Hemostatic Forceps

CODE	DESCRIPTION	LENGTH
32-4050	Straight, Bright Finish	6¼ in 159 mm



Rochester-Carmalt Hemostatic Forceps

Bright Finish

CODE	DESCRIPTION	LENGTH
32-4141	Curved	6½ in 165 mm
32-4151	Curved	8 in 203 mm



32-4151

Forceps (Hemostatic)

Rochester Ochsner Forceps

1 x 2 Teeth

CODE	DESCRIPTION	LENGTH
16-1216	Straight	6¼ in 159 mm
16-1218	Straight	7¼ in 184 mm
16-1220	Straight	8 in 203 mm
16-1222	Straight	8¾ in 222 mm
16-1224	Straight	9½ in 241 mm
16-1226	Straight	10 in 254 mm
16-1228	Straight	12 in 305 mm
16-1240	Straight	16 in 406 mm
16-1245	Straight	18 in 458 mm
16-1316	Curved	6¼ in 159 mm
16-1318	Curved	7¼ in 184 mm
16-1320	Curved	8 in 203 mm
16-1322	Curved	8¾ in 222 mm
16-1324	Curved	9½ in 241 mm
16-1326	Curved	10 in 254 mm
16-1328	Curved	12 in 305 mm
16-1330	Curved	14 in 356 mm
16-1340	Curved	16 in 406 mm
16-1345	Curved	18 in 458 mm

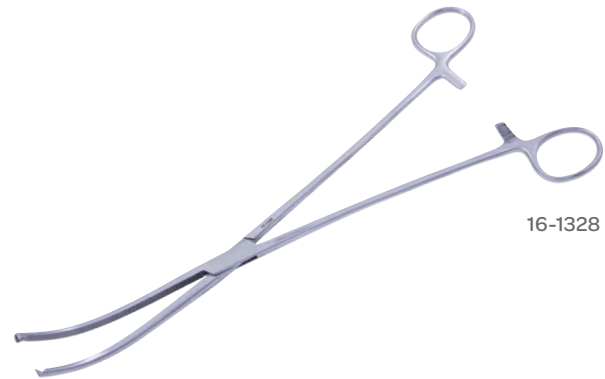

16-1328

Rochester-Pean Hemostatic Forceps

CODE	DESCRIPTION	LENGTH
32-3553	Curved	12 in 305 mm
32-3554	Curved	14 in 356 mm
30-4565	Curved, Cross-Serrations	9 in 229 mm
30-4573	Curved, Cross-Serrations	10 in 254 mm



32-3553

Rochester-Carmalt Hemostatic Forceps

CODE	DESCRIPTION	LENGTH
30-8092	Curved Longitudinal Serrations	12¼ in 311 mm



Forceps (Hemostatic)

Rochester-Pean Hemostatic Forceps

CODE	DESCRIPTION	LENGTH
16-1014	Straight	5½ in 140 mm
16-1016	Straight	6¼ in 159 mm
16-1018	Straight	7¼ in 184 mm
16-1020	Straight	8 in 203 mm
16-1022	Straight	8¾ in 222 mm
16-1024	Straight	9½ in 241 mm
16-1026	Straight	10¼ in 260 mm
16-1030	Straight	14 in 356 mm
16-1114	Curved	5½ in 140 mm
16-1116	Curved	6½ in 165 mm
16-1118	Curved	7¼ in 184 mm
16-1120	Curved	8 in 203 mm
16-1122	Curved	8¾ in 222 mm
16-1124	Curved	9½ in 241 mm
16-1126	Curved	10¼ in 260 mm
16-1128	Curved	11¾ in 298 mm
16-1130	Curved	14 in 356 mm
16-1140	Curved	16 in 406 mm
16-1145	Curved	18 in 458 mm



16-1014

Rochester-Pean Forceps

CODE	DESCRIPTION	LENGTH
30-4563	Straight, Cross-Serrations	9 in 229 mm
30-8093	Curved	12 in 305 mm



30-4563

Forceps (Hemostatic)

Rochester-Ochsner Forceps

CODE	DESCRIPTION	LENGTH
32-4110	Straight, 1 x 2 Teeth	6 ¼ in 159 mm
32-4120	Straight, 1 x 2 Teeth	7 ¼ in 184 mm
32-4130	Straight, 1 x 2 Teeth	7 ¼ in 184 mm
33-4110	Straight, 1 x 2 Teeth, Bright Finish	6 ¼ in 159 mm
33-4120	Straight, 1 x 2 Teeth, Bright Finish	7 ¼ in 184 mm
34-4110	Straight, 1 x 2 Teeth, Low-Glare Finish	6 ¼ in 159 mm
34-4120	Straight, 1 x 2 Teeth, Low-Glare Finish	7 ¼ in 184 mm
32-4111	Curved, 1 x 2 Teeth	6 ¼ in 159 mm
32-4121	Curved, 1 x 2 Teeth	7 ¼ in 184 mm
32-4131	Curved, 1 x 2 Teeth	7 ¼ in 184 mm
30-4066	Straight	9 in 229 mm
30-8090	Straight	10 in 254 mm
32-3539	Straight, Serrated, 1 x 2 Teeth	14 in 356 mm



30-4066

Rochester-Pean Classic® Forceps

Standard Line

CODE	DESCRIPTION	LENGTH
32-4070	Straight	6 ¼ in 159 mm
32-4080	Straight	7 ¼ in 184 mm
33-4071	Curved, Bright Finish	6 ¼ in 159 mm
32-4071	Curved	6 ½ in 165 mm
32-4081	Curved	7 ¼ in 184 mm
32-4091	Curved	8 in 203 mm



33-4071

Schmidt Hemostatic Forceps

CODE	DESCRIPTION	LENGTH
30-4290	Full Curved	7 ¼ in 184 mm
30-4291	Slightly Curved	7 ¼ in 184 mm



Forceps (Hysterectomy)

Heaney Hysterectomy Forceps

Curved, Jaw Length 1½ in (38 mm)

CODE	DESCRIPTION	LENGTH
30-5525	Light Jaws, Single Tooth	8¼ in 210 mm
30-5526	Heavy Jaws, Single Tooth	8¼ in 210 mm
30-5527	Heavy Jaws, Double Tooth	8¼ in 210 mm



Heaney-Kanter Hysterectomy Forceps

CODE	DESCRIPTION	LENGTH
30-5529	Curved, Double Tooth, Jaw Length 1¾ in (44 mm)	8½ in 216 mm



Heaney-Rezak Hysterectomy Forceps

CODE	DESCRIPTION	LENGTH
30-5800	Straight, Single Tooth, Jaw Length 1⅞ in (48 mm)	8½ in 216 mm



Forceps (Intestinal)

Allen Intestinal Forceps

CODE	DESCRIPTION	LENGTH
50-1038	Straight, 1x2 Teeth	6½ in 165 mm



Babcock Intestinal Forceps

Jaws with Atraumatic Parallel Serrations

CODE	DESCRIPTION	LENGTH
50-1116	Straight	6¼ in 159 mm
50-1123	Straight	9¾ in 238 mm

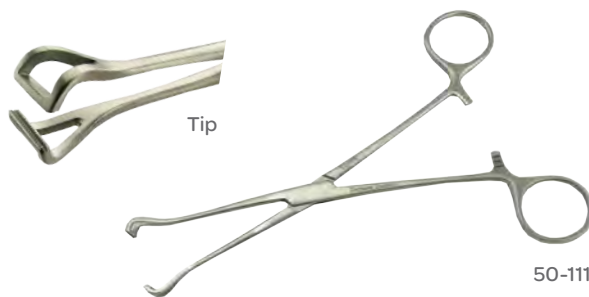

50-1116

Doyen Intestinal Forceps

Jaws with Atraumatic Serrations

CODE	DESCRIPTION	LENGTH
50-1673	Straight	9 in 229 mm
50-1773	Curved	9 in 229 mm

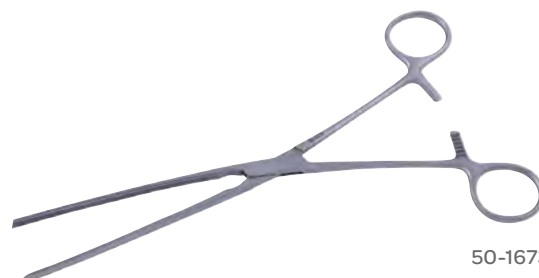

50-1673

Doyen Intestinal Forceps

Diagonal Serrations, Jaw Length 4 1/8 in (105 mm)

CODE	DESCRIPTION	LENGTH
30-4305	Straight	9¼ in 235 mm
30-4306	Curved	9¼ in 235 mm

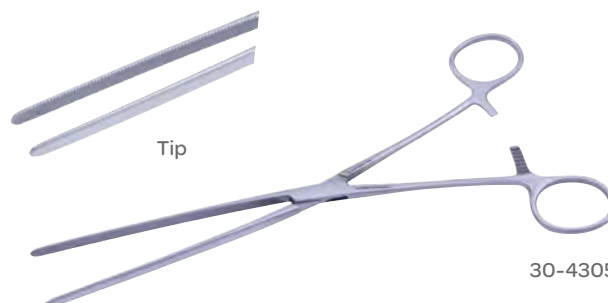

30-4305

Forceps (Intestinal)

Doyen-Baby Intestinal Forceps

Delicate Pattern

CODE	DESCRIPTION	LENGTH	
50-1617	Straight	7 in	178 mm
50-1717	Curved	7 in	178 mm



Forceps (Iris)

Iris Forceps

Extremely Delicate

CODE	DESCRIPTION	LENGTH	
06-3010	Straight, Serrated	4 in	102 mm
06-3030	Strongly Curved, Serrated	4 in	102 mm
06-3110	Straight, 1x2 Teeth	4 in	102 mm
06-3130	Strongly Curved, 1x2 Teeth	4 in	102 mm



Forceps (Jewelers)

Jewelers Forceps

Extra Fine Point

CODE	DESCRIPTION	LENGTH	
60-1690	Straight, Style #3	4 ⁵ / ₈ in	117 mm
60-1692	Straight, Style #4	4 ¹ / ₄ in	108 mm
60-1693	Straight, Style #5	4 ¹ / ₄ in	108 mm
60-1694	Curved, Style #7	4 ⁵ / ₈ in	117 mm



Forceps (Kidney Stone)

Randall Kidney Stone Forceps

CODE	DESCRIPTION	LENGTH	
51-5801	#1, One Quarter Curve	9 in	229 mm
51-5802	#2, One Half Curve	9 in	229 mm
51-5803	#3, Three Quarter Curve	9 in	229 mm
51-5804	#4, Full Curve	9 in	229 mm



51-5801

Forceps (Ligature)

Semb Ligature Carrying Forceps

CODE	DESCRIPTION	LENGTH	
30-8056	Acute Curve	9½ in	241 mm



Forceps (Lung Grasping)

Lovelace Lung Grasping Forceps

CODE	DESCRIPTION	LENGTH	
54-5019	Angled to Side, 25 mm Jaw, Triangular Jaw	8 in	203 mm

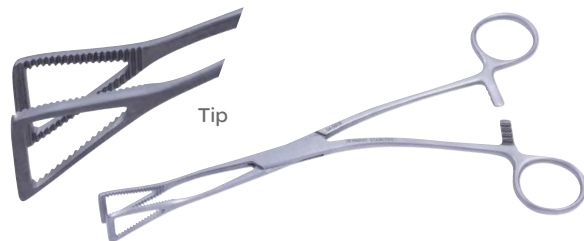

Forceps (Micro)

Micro Forceps

Straight

CODE	TIP WIDTH	LENGTH	
80-2000	0.3 mm	5½ in	140 mm
80-2009	0.3 mm	7 in	178 mm
80-2010	0.7 mm	7 in	178 mm



80-2000

Forceps (Micro)

Jacobson Micro Forceps

CODE	DESCRIPTION	LENGTH	
07-7015	Fine Sharp Tips	6 in	152 mm
07-7018	Fine Sharp Tips	7 $\frac{1}{8}$ in	181 mm



07-7015

Jacobson-Adson Micro Forceps

CODE	DESCRIPTION	LENGTH	
07-6612	Sharp Tips	4 $\frac{3}{4}$ in	121 mm



Forceps (Micro Artery)

Jacobson Micro Artery Forceps

CODE	DESCRIPTION	LENGTH	
16-4088	Straight	7 in	178 mm
16-4188	Slight Curve	7 in	178 mm
16-4189	Full Curve	7 in	178 mm



16-4189

Forceps (Micro Bayonet)

Yasargil Micro Bayonet Forceps

CODE	TIP WIDTH	LENGTH	
58-1566	9.0 mm	9 $\frac{1}{2}$ in	241 mm



Forceps (Mosquito)

Halsted Mosquito Forceps

CODE	DESCRIPTION	LENGTH
15-4412	Straight, Standard Pattern	4 ³ / ₄ in 121 mm
15-4612	Straight, 1 x 2 Teeth Standard Pattern	4 ³ / ₄ in 121 mm
15-4512	Curved, Standard Pattern	4 ³ / ₄ in 121 mm
15-4712	Curved, 1 x 2 Teeth Standard Pattern	4 ³ / ₄ in 121 mm



15-4412

Halsted Classic® Mosquito Forceps

Low-Glare Finish

CODE	DESCRIPTION	LENGTH
34-3900	Straight	3 ¹ / ₂ in 89 mm
32-3900	Straight, Standard Line	3 ¹ / ₂ in 89 mm
32-4000	Straight, Standard Line	5 in 127 mm
33-4000	Straight, Bright Finish	5 in 127 mm
32-3901	Curved, Standard Line	3 ¹ / ₂ in 89 mm
32-4001	Curved, Standard Line	5 in 127 mm
34-3901	Curved	3 ¹ / ₂ in 89 mm
34-4001	Curved	5 in 127 mm
33-3901	Curved, Bright Finish	3 ¹ / ₂ in 89 mm
33-4001	Curved, Bright Finish	5 in 127 mm



34-3900



32-3900

Micro Halsted Mosquito Forceps

CODE	DESCRIPTION	LENGTH
15-4002	Curved	6 in 152 mm



Forceps (Mosquito)

Providence Hospital Mosquito Forceps

CODE	DESCRIPTION	LENGTH
15-5014	Straight	5½ in 140 mm
15-5114	Curved	5½ in 140 mm



15-5014

Skillman Packer Mosquito Forceps

CODE	DESCRIPTION	LENGTH
15-4582	Curved	5 in 127 mm



Micro Jacobson Mosquito Forceps

Very Slender Pattern

CODE	DESCRIPTION	LENGTH
15-3501	Straight	4 in 102 mm
15-4082	Straight	5 in 127 mm
15-3502	Curved	3⅞ in 98 mm
15-4182	Curved	4⅜ in 106 mm



15-3501

Micro-Halsted Mosquito Forceps

Very Slender Pattern

CODE	DESCRIPTION	LENGTH
15-4012	Straight	4¾ in 121 mm
15-4112	Curved	4¾ in 121 mm



15-4012

Forceps (Mosquito Artery)

Hartmann-Baby Mosquito Artery Forceps

CODE	DESCRIPTION	LENGTH
15-3209	Straight	3 ⁷ / ₈ in 98 mm
15-3309	Curved	3 ⁷ / ₈ in 98 mm



Forceps (Pile Clamp)

Buie Pile Clamp

CODE	DESCRIPTION	LENGTH
16-3921	Curved	8 ⁵ / ₈ in 219 mm



Forceps (Skin Hook)

Lalonde Skin Hook Forceps

CODE	DESCRIPTION	LENGTH
20-5003	Extra Fine	4 ³ / ₄ in 121 mm

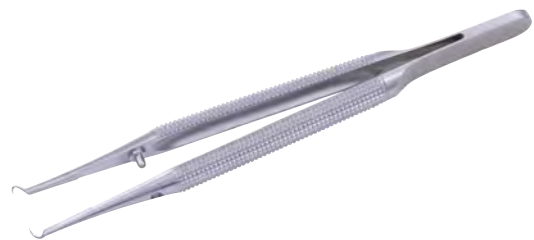

Forceps (Splinter)

Feilchenfeld Splinter Forceps

CODE	DESCRIPTION	LENGTH
07-8211	Splinter Forceps	4 ¹ / ₂ in 114 mm



Forceps (Splinter)

Ralks (Virtus) Splinter Forceps

CODE	DESCRIPTION	LENGTH
07-9424	Angled	5½ in 140 mm
07-9425	Angled	6 in 152 mm



07-9424

Splinter Forceps

CODE	DESCRIPTION	LENGTH
07-8009	Straight	3½ in 89 mm
07-8010	Straight	4¼ in 105 mm
07-8011	Straight	4⅝ in 117 mm
07-8681	Straight, with Detachable Magnifying Glass	4⅜ in 111 mm
07-8108	Angled	3⅛ in 79 mm
07-8109	Angled	3½ in 89 mm
07-8110	Angled	4¼ in 105 mm
07-8111	Angled	4½ in 114 mm



07-8009

Virtus Splinter Forceps

CODE	DESCRIPTION	LENGTH
30-4258	Straight, Sharp Tips	6 in 152 mm



Walter Splinter Forceps

CODE	DESCRIPTION	LENGTH
07-8611	Straight	4¼ in 108 mm
30-4255	Straight, Sharp Tips	4¼ in 108 mm
07-8621	Curved	4⅛ in 105 mm



30-4255

Forceps (Splinter)

Williams Splinter Forceps

CODE	DESCRIPTION	LENGTH
07-9114	Straight	5½ in 140 mm

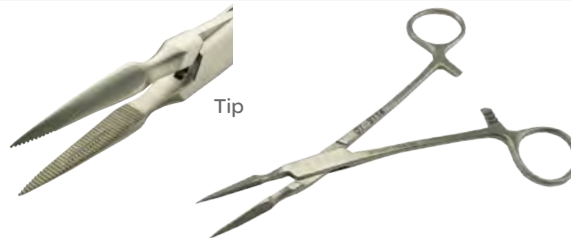

Peet Splinter Forceps

CODE	DESCRIPTION	LENGTH
07-9011	Splinter Forceps	4½ in 114 mm



Forceps (Sponge)

Sponge Holding Forceps

Serrated Jaws, Bright Finish

CODE	DESCRIPTION	LENGTH
32-6010	Straight	7 in 178 mm
32-6030	Straight	9 in 229 mm
32-6031	Curved	9 in 229 mm

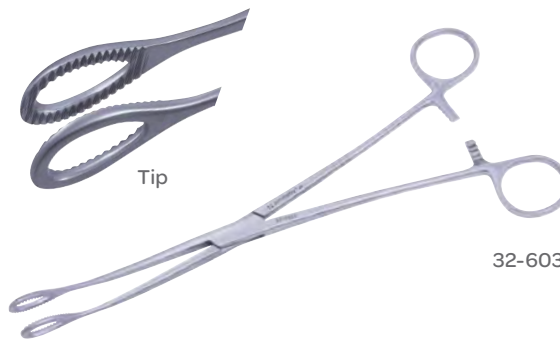

Sponge Classic® Holding Forceps

Serrated Jaws, Bright Finish

CODE	DESCRIPTION	LENGTH
33-6031	Curved	9 in 229 mm

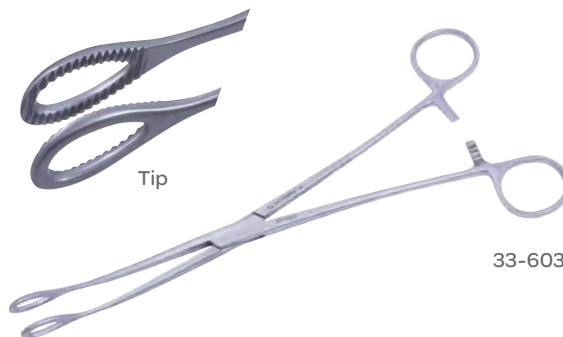

Forceps (Sponge)

Bariatric Sponge Forceps

CODE	DESCRIPTION	LENGTH
32-3540	Straight, Serrated Jaws	14 in 356 mm



Bergmann-Forester Sponge Forceps

Serrated, Small Loop Jaws

CODE	DESCRIPTION	LENGTH
19-5424	Straight	9 ⁵ / ₈ in 244 mm
19-5524	Curved	9 ⁵ / ₈ in 244 mm

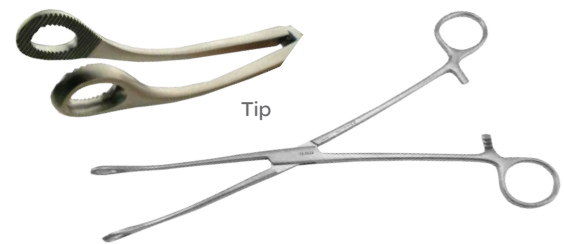

19-5524

Fletcher (Javerts) Sponge Forceps

Serrated, Narrow Loop Jaws

CODE	DESCRIPTION	LENGTH
19-5824	Straight	9 ⁷ / ₈ in 251 mm
19-5924	S-Shape	9 ⁷ / ₈ in 251 mm

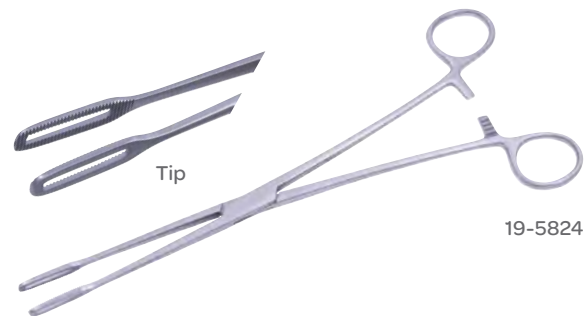

19-5824

Foerster Sponge Forceps

CODE	DESCRIPTION	LENGTH
19-5024	Straight, Serrated Jaws	9 ³ / ₄ in 248 mm
19-5029	Straight, Serrated Jaws	12 in 305 mm
19-5030	Straight, Serrated Jaws	14 in 356 mm
19-5040	Straight, Serrated Jaws	16 in 406 mm
19-5045	Straight, Serrated Jaws	18 in 458 mm
19-5224	Straight, Smooth Jaws	9 ¹ / ₂ in 241 mm
19-5124	Curved, Serrated Jaws	9 ¹ / ₂ in 241 mm
19-5324	Curved, Smooth Jaws	9 ¹ / ₂ in 241 mm



19-5024

Forceps (Sponge)

Foerster (Ballenger) Sponge Forceps

CODE	DESCRIPTION	LENGTH	
19-5017	Straight, Smooth Jaws	7 in	178 mm
19-5018	Straight, Serrated Jaws	7½ in	181 mm
19-5118	Curved, Serrated Jaws	7½ in	181 mm



19-5017

Foerster Sponge Forceps

CODE	DESCRIPTION	LENGTH	
19-5029E	Straight, Serrated Ebonized	12 in	305 mm
19-5129	Curved, Serrated Jaws	12 in	305 mm
19-5031	Curved, Serrated Jaws	14 in	356 mm



19-5129

Forceps (Stomach & Intestinal)

Glassman Stomach & Intestinal Forceps

2½ in (64 mm) Jaws with Atraumatic Serrations

CODE	DESCRIPTION	LENGTH	
50-3024	Straight	9½ in	241 mm
50-3124	Angled	9¼ in	235 mm

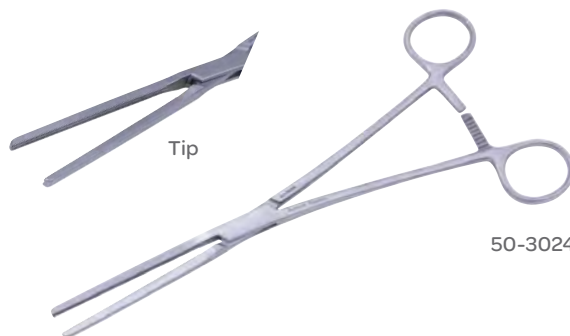

50-3024

Forceps (Stomach Resection Clamps)

Glassman Stomach Resection Clamps

Jaws with Serrations

CODE	DESCRIPTION	JAWS	LENGTH		
50-3225	Straight	4 1/8 in	105 mm	11 in	279 mm
50-3172	Angled 90°	2 in	51 mm	9 7/8 in	251 mm
50-3174	Angled 90°	3 in	76 mm	9 7/8 in	251 mm
50-3325	Angled	4 1/8 in	105 mm	10 1/4 in	260 mm



50-3172

Forceps (Suture)

Bonn Suture Forceps

0.12 mm Teeth, Extra Delicate

CODE	DESCRIPTION	LENGTH	
60-1641	Without Platform	3 in	76 mm
60-1660	With Platform	3 3/4 in	95 mm



60-1660

Castroviejo Suture Forceps

With Platform, Wide Handle

CODE	TEETH	LENGTH	
60-1629	0.12 mm	4 1/4 in	108 mm
60-1631	0.3 mm	4 1/4 in	108 mm
60-1632	0.5 mm	4 1/4 in	108 mm
60-1637	0.9 mm	4 1/4 in	108 mm
60-1634	1.5 mm	4 1/4 in	108 mm
60-1630	0.12 mm, Angled on Shaft	4 1/8 in	105 mm
60-1628	0.3 mm, Angled on Shaft	4 1/8 in	105 mm
60-1627	0.5 mm, Angled on Shaft	4 1/8 in	105 mm

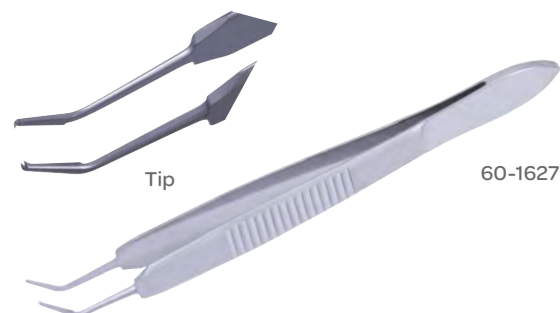

60-1627

Micro Suture Forceps

CODE	DESCRIPTION	LENGTH	
13-7042	0.3 mm Tip, with Tying Platform, Flat Handle	4 1/8 in	105 mm



Forceps (Suture)

Castroviejo Suture Forceps

With Platform, 1 x 2 Teeth

CODE	TIP WIDTH	LENGTH
60-1638	0.12 mm	4¼ in 108 mm
60-1639	0.3 mm	4¼ in 108 mm
60-1635	0.5 mm	4¼ in 108 mm



60-1638

Jaffe-Castroviejo Suture Forceps

With Platform, 1 x 2 Teeth

CODE	TIP WIDTH	LENGTH
60-1621	0.12 mm	4¼ in 108 mm



Sauer Suture Forceps

CODE	DESCRIPTION	LENGTH
60-1650	1 x 2 Teeth at Oblique Angle to Shaft	3½ in 89 mm



Forceps (Suture Stay)

Castaneda Suture Tag Forceps

Smooth Jaws

CODE	DESCRIPTION	LENGTH
30-9007	#1	3½ in 89 mm
30-9008	#2	3½ in 89 mm
30-9009	#3	3½ in 89 mm
30-9010	#4	3½ in 89 mm



30-9007

Forceps (Suture Stay)

Gregory Suture Stay Forceps

Smooth Jaws

CODE	DESCRIPTION	JAW LENGTH	LENGTH
19-8026	#1, Gold	$\frac{5}{8}$ in 98 mm	4 $\frac{3}{4}$ in 121 mm
19-8027	#2, Gold Large	$\frac{3}{4}$ in 16 mm	4 $\frac{3}{4}$ in 121 mm
19-8029	#4, Gold Large	1 $\frac{5}{8}$ in 19 mm	4 $\frac{3}{4}$ in 121 mm
17-8026		3 $\frac{7}{8}$ in 41 mm	



17-8026

Forceps (Tebbetts)

Tebbetts Forceps

Tungsten Carbide Inserts

CODE	TIP	LENGTH
32-551	5.0 mm	4 $\frac{3}{4}$ in 121 mm
32-552	9.0 mm	4 $\frac{3}{4}$ in 121 mm



32-552

Forceps (Tendon)

Carroll Tendon Pulling Forceps

CODE	SHAFT LENGTH	JAW DIAMETER	LENGTH
30-2540	5 in (127 mm)	$\frac{3}{8}$ in 10 mm	7 $\frac{1}{2}$ in 191 mm



Forceps (Thoracic)

Harrington Thoracic Clamp Forceps

CODE	DESCRIPTION	LENGTH
30-8049	Right Angled, Longitudinal Serrations with Cross-Serrated Tips	12 in 305 mm

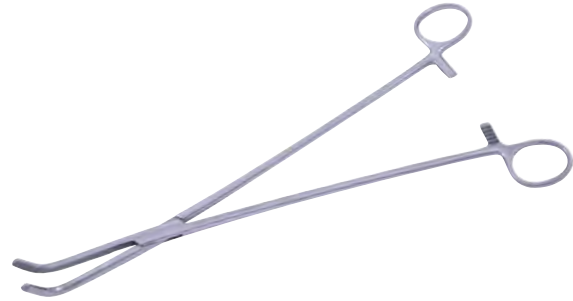

Julian Thoracic Artery Forceps

CODE	DESCRIPTION	LENGTH
37-4034	Slightly Curved, 24 mm Jaw Length	9 ¼ in 235 mm



Kantrowitz Thoracic Forceps

CODE	DESCRIPTION	LENGTH
54-5003	Angled, Delicate, 90°	7 ½ in 191 mm
54-5000	Angled, Delicate, 90°	6 ½ in 166 mm



Rumel Thoracic Forceps

CODE	DESCRIPTION	LENGTH
30-8070	#1, Slight Curve	9 in 229 mm
30-8072	#2, Full Curve	9 in 229 mm
30-8073	#4, Right Angle	9 in 229 mm

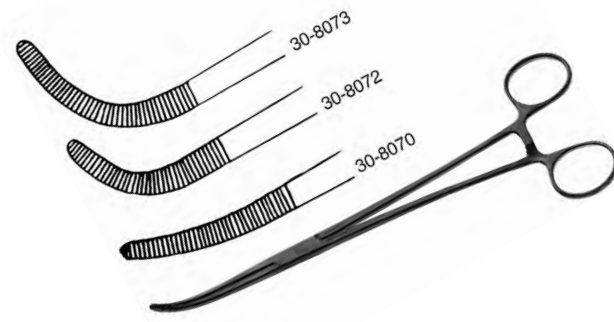

Forceps (Tissue)

Adair-Allis Tissue Forceps

CODE	TEETH	LENGTH
50-0417	9x10	9 in 229 mm
50-0415	9x10 Teeth	6 in 152 mm



50-0417

Adson Tissue Forceps

CODE	TEETH	LENGTH
06-2113	1x2 with Serrations	4 3/4 in 121 mm
06-2113E	1x2 with Serrations, Ebonized	4 3/4 in 121 mm
06-2413	2x3	4 3/4 in 121 mm

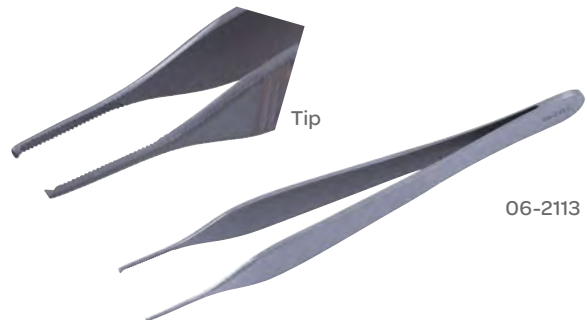

06-2113

Adson Brown Forceps

Tungsten Carbide Inserts

CODE	TEETH	LENGTH
32-502	7x7	4 3/4 in 121 mm
32-506	7x7	4 3/4 in 121 mm
32-507	7x7	6 in 152 mm
32-536	4x4	4 3/4 in 121 mm



32-502

Adson Forceps

CODE	DESCRIPTION	LENGTH
32-512	With Hooks, Tungsten Carbide Inserts	5 in 127 mm



Forceps (Tissue)

Adson Tissue Forceps

Tungsten Carbide Inserts

CODE	DESCRIPTION	LENGTH
32-504	Micro, 1x2 Teeth	4 ³ / ₄ in 121 mm

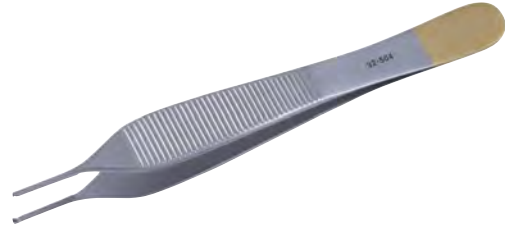

Adson Tissue Forceps

Tungsten Carbide Inserts

CODE	DESCRIPTION	LENGTH
32-509	Standard, 1x2 Teeth	6 in 152 mm



Adson Tissue Forceps

Tungsten Carbide Inserts

CODE	DESCRIPTION	LENGTH
32-503	1x2 Teeth	4 ³ / ₄ in 121 mm



Adson Tissue Forceps

CODE	TIP WIDTH	TEETH	LENGTH
30-1186	1.2 mm	1x2	5 in 127 mm
30-1187	1.8 mm	2x3	5 in 127 mm
30-1188	3.0 mm	2x3	7 in 178 mm
30-4218	0.7 mm Delicate		5 in 127 mm
36-6000	Tip Width 2.0 mm, Tungsten Carbide Inserts		4 ³ / ₄ in 121 mm



Forceps (Tissue)

Adson-Brown Tissue Forceps

CODE	DESCRIPTION	TEETH	LENGTH
06-2512	Straight	7x7	4 ³ / ₄ in 121 mm
06-2572	Angled	7x7	4 ³ / ₄ in 121 mm



06-2512

Adson-Graefe (Beasley) Forceps

CODE	DESCRIPTION	LENGTH
06-2582	Multiple Teeth	4 ³ / ₄ in 121 mm



Adson-Brown Tissue Forceps

CODE	TIP WIDTH	TEETH	LENGTH
30-1189	1.7 mm	1x2	5 in 127 mm



Allis Tissue Forceps

CODE	DESCRIPTION	LENGTH
50-0215	Standard Pattern, 4 x 5 Teeth	6 in 152 mm
50-0216	Standard Pattern, 5 x 6 Teeth	6 in 152 mm
50-0219	Standard Pattern, 5 x 6 Teeth	7 ¹ / ₂ in 191 mm
50-0223	Standard Pattern, 5 x 6 Teeth	9 ¹ / ₂ in 241 mm
50-0224	Standard Pattern, 5 x 6 Teeth	9 ³ / ₄ in 248 mm
50-0226	Standard Pattern, 5 x 6 Teeth	12 in 305 mm
50-0245	Standard Pattern, 5 x 6 Teeth	18 in 458 mm
50-0315	Narrow Jaws, Atraumatic Parallel Serrations	6 in 152 mm
50-0320	Narrow Jaws Atraumatic Parallel Serrations	8 in 203 mm
50-0316	Jaws with Atraumatic Parallel Serrations	6 in 152 mm
50-0319	Jaws with Atraumatic Parallel Serrations	7 ¹ / ₂ in 191 mm

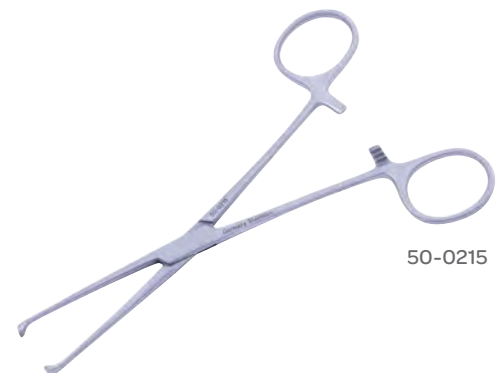

50-0215

Forceps (Tissue)

Allis Classic® Delicate Tissue Forceps

CODE	TEETH	LENGTH
30-4466	5 x 6	5 in 127 mm



Allis Classic® Tissue Forceps

CODE	TEETH	DESCRIPTION	LENGTH
32-7000	4 x 5	Standard Line	6 in 152 mm
32-7001	5 x 6	Standard Line	6 in 152 mm
32-7010	5 x 6	Standard Line	7¼ in 184 mm
34-7000	4 x 5	Low-Glare Finish	

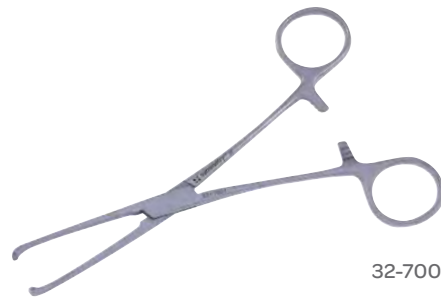

32-7001

Allis-Adair Tissue Forceps

CODE	TEETH	LENGTH
30-4542	9 x 10	6 in 152 mm



Allis-Baby Tissue Forceps

CODE	DESCRIPTION	LENGTH
50-0213	Delicate Pattern, 4 x 5 Teeth	5 in 127 mm



Forceps (Tissue)

Babcock Tissue Forceps

CODE	DESCRIPTION	LENGTH
50-1016	Standard Pattern	6¼ in 159 mm
50-1023	Standard Pattern	9½ in 241 mm
50-1024	Standard Pattern	12 in 305 mm
50-1040	Standard Pattern	16 in 405 mm
50-1045	Standard Pattern	18 in 458 mm

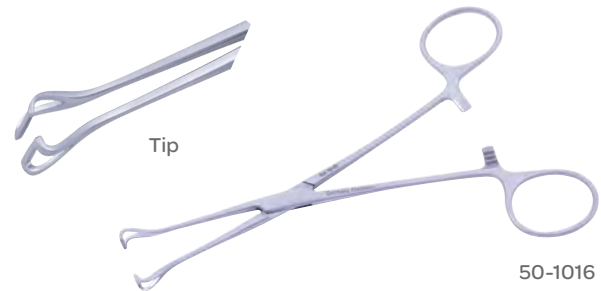

Babcock Baby Tissue Forceps

CODE	DESCRIPTION	LENGTH
50-1015	Extra Delicate Jaws	6¼ in 159 mm



Babcock Classic® Delicate

CODE	DESCRIPTION	LENGTH
30-4465	Tissue Forceps	5½ in 140 mm



Babcock Classic® Tissue Forceps

CODE	DESCRIPTION	LENGTH
32-7020	Standard Line	6¼ in 159 mm
32-7025	Standard Line	7¾ in 197 mm
32-7030	Standard Line	9½ in 241 mm
33-7020	Bright Finish	6¼ in 159 mm
33-7025	Bright Finish	7¾ in 197 mm
34-7025	Low-Glare Finish	7¾ in 197 mm

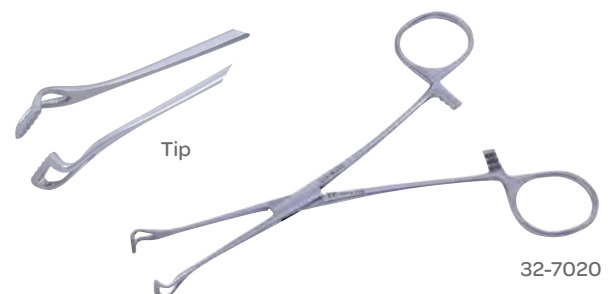

Forceps (Tissue)

Babcock Tissue Forceps

CODE	DESCRIPTION	LENGTH
36-6050	Tungsten Carbide Jaw Inserts	6¼ in 159 mm



Ballentine Hysterectomy Forceps

CODE	DESCRIPTION	LENGTH
30-5801	Straight, Single Tooth Jaw Length 1¾ in (44 mm)	8½ in 216 mm



Bariatric Tissue Forceps Babcock

CODE	DESCRIPTION	LENGTH
32-3544	Straight	12 in 305 mm
32-3545	Serrated	14 in 356 mm



32-3544

Bariatric Forceps

CODE	DESCRIPTION	LENGTH
32-3551	Right-Angled	12¼ in 311 mm
32-3552	Right-Angled	14 in 356 mm

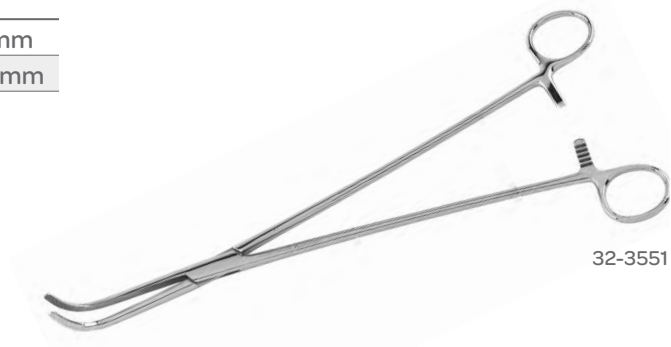

32-3551

Forceps (Tissue)

Bariatric Russian Tissue Forceps

CODE	DESCRIPTION	LENGTH
32-3543	Side Grasping Teeth	14 in 356 mm



Bariatric Thumb Forceps

CODE	DESCRIPTION	LENGTH
32-3541	3.4 mm Tip	14 in 356 mm
32-3542	1 x 2 Teeth	14 in 356 mm



32-3541

Barnes-Crile Classic® Forceps

CODE	DESCRIPTION	LENGTH
32-4043	Curved, Bright Finish	6 ¼ in 159 mm



Bishop Harmon Tissue Forceps

CODE	DESCRIPTION	LENGTH
60-1524	Cross-Serrated Tips	3 ¾ in 75 mm
60-1522	1 x 2 Teeth	3 ½ in 86 mm



60-1522

Forceps (Tissue)

Bishop Harmon Tissue Forceps

1x2 Teeth

CODE	TIP WIDTH	LENGTH
30-6555	5.0 mm, Standard	3¼ in 83 mm
30-6556	0.3 mm, Delicate	3¼ in 83 mm



30-6555

Bonney Tissue Forceps

CODE	TEETH	LENGTH
06-8791	1x2 Teeth	7⅞ in 181 mm
06-8782	1x2 Teeth	10 in 254 mm
06-8790	2x3 Teeth	7⅞ in 181 mm
06-8795	2x3 Teeth	12 in 305 mm



06-8791

Bonney Tissue Forceps

CODE	TIP WIDTH	TEETH	LENGTH
30-1129	3.0 mm	1x2	6¾ in 171 mm



Boston Lying-In Cervical Grasping Forceps

CODE	DESCRIPTION	LENGTH
30-5570	Fenestrated	9½ in 241 mm

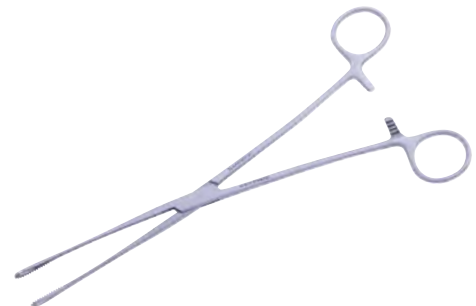

Forceps (Tissue)

Boys-Allis Tissue Forceps

CODE	DESCRIPTION	LENGTH
50-0715	5 x 6 Teeth	6 in 152 mm



Bridge Forceps

CODE	DESCRIPTION	LENGTH
54-5010	Straight	11 in 279 mm
54-5009	Curved	7½ in 191 mm
54-5011	Curved	11 in 279 mm
30-4700	Curved	11 in 279 mm

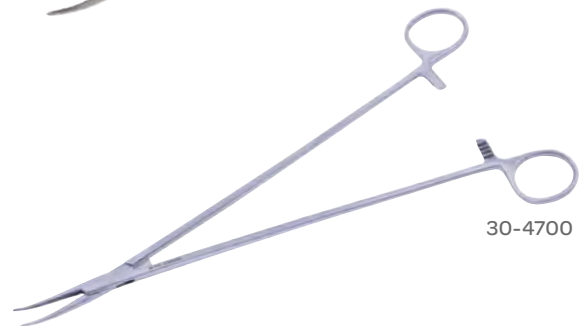

Bridge Forceps

CODE	DESCRIPTION	LENGTH
54-5021	Curved	14 in 356 mm

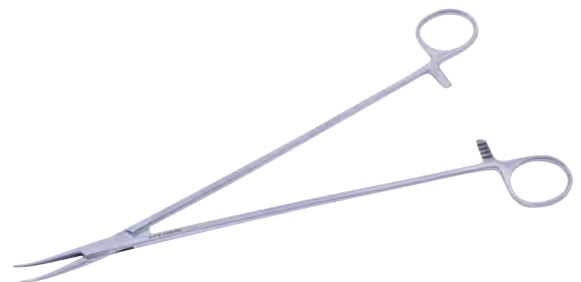

Forceps (Tissue)

Brigham Brain Tumor Forceps

CODE	RING JAW DIAMETER	LENGTH
30-1117	$\frac{3}{8}$ in (10 mm)	7 $\frac{3}{8}$ in 187 mm

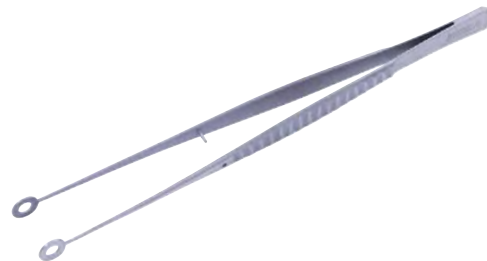

Brigham Tissue Forceps

CODE	TIP	TEETH	LENGTH
30-4239	2.2 mm Dissecting End	1 x 2	5 $\frac{1}{2}$ in 140 mm



Brown Tissue Forceps

CODE	DESCRIPTION	LENGTH
07-1015	Side-Grasping Teeth	6 in 152 mm
07-1020	Side-Grasping Teeth	8 in 203 mm
07-1025	Side-Grasping Teeth	10 in 254 mm
07-1030	Side-Grasping Teeth	12 in 305 mm
30-4200	Tip Width 2.2 mm Parallel Multiple Teeth	6 $\frac{1}{4}$ in 159 mm
30-4201	Tip Width 3.1 mm Parallel Multiple Teeth	8 in 203 mm



Cartilage & Meniscus Forceps

CODE	DESCRIPTION	LENGTH
35-2021	Forceps	

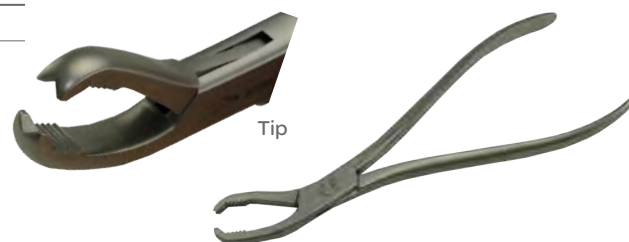

Forceps (Tissue)

Castaneda Vascular Forceps

Titanium

CODE	DESCRIPTION	LENGTH	
30-8500	Tip Width 1.7 mm 1 x 2 Vascular Teeth Grooved with Cross Serrations	6 in	152 mm



Classic Plus® General Surgery Dressing Forceps

Fine Tungsten Carbide Inserts

CODE	TIP WIDTH	LENGTH	
36-6010	1.8 mm Tip,	6 in	152 mm



Coller Forceps

CODE	DESCRIPTION	LENGTH	
30-4035	Curved	6¼ in	159 mm



Cooley Vascular Tissue Forceps

CODE	TIP WIDTH	LENGTH	
37-4028	1.0 mm, Cross-Serrated Jaws	8 in	203 mm



Forceps (Tissue)

Cushing Tissue Forceps

CODE	DESCRIPTION	LENGTH	
32-520	Straight, Tungsten Carbide Inserts, Dissector Handle End	7 in	178 mm
36-6005	Straight 1.4 mm, Tip Tungsten Carbide Inserts	7 in	178 mm
32-525	Bayonet, Tungsten Carbide Inserts, Dissector Handle End	7½ in	191 mm
36-6007	Bayonet, 1.4 mm Tip Tungsten Carbide Inserts	7¾ in	197 mm
30-1140	Tip Width 1.5 mm, 1 x 2 Teeth Serrated Handle	7 in	178 mm
30-1142	Tip Width 1.7 mm, 1 x 2 Teeth Gutsch Handle	7 in	178 mm
30-1143	Tip Width 1.3 mm, 1 x 2 Teeth Gutsch Handle, Fine Tip	7 in	178 mm
30-1145	Tip Width 1.6 mm, 1 x 2 Teeth	7¾ in	197 mm



30-1140

Cushing-Brown Bayonet Tissue Forceps

CODE	DESCRIPTION	LENGTH	
07-2879	Tissue Forceps	7½ in	191 mm

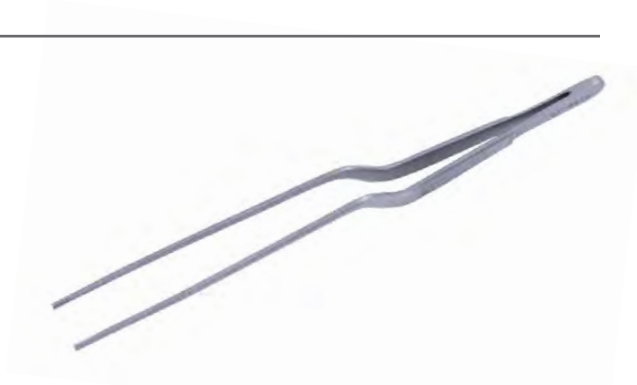

D&y Scalp Forceps

Curved on One Side, Bright Finish

CODE	TEETH	LENGTH	
32-4160	1 x 2 Serrated	5½ in	140 mm
32-4161	1 x 2 Teeth	5½ in	140 mm



32-4161

Forceps (Tissue)

DeBakey-Collier Tissue Forceps

CODE	DESCRIPTION	LENGTH
32-3549	Angled, Serrated	14 in 356 mm

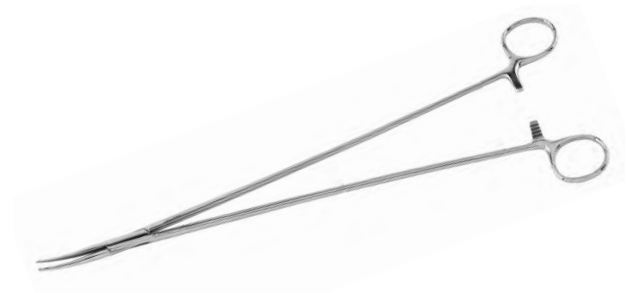

DeBakey Needle Pulling Tissue Forceps

DeBakey Teeth, Tungsten Carbide Inserts Behind Teeth

CODE	DESCRIPTION	LENGTH
32-559	1.5 mm Tip	7 ³ / ₈ in 187 mm



DeBakey Tissue Forceps

DeBakey Teeth, Tungsten Carbide Inserts Behind Teeth

CODE	TIP	LENGTH
32-564	1.5 mm	6 in 152 mm
32-565	1.5 mm	8 ¹ / ₄ in 210 mm
32-566	1.5 mm	9 ⁵ / ₈ in 244 mm
32-560	2.0 mm	6 in 152 mm
32-561	3.0 mm	7 ⁷ / ₈ in 200 mm
32-562	3.0 mm	9 ¹ / ₂ in 241 mm
32-563	3.0 mm	12 in 305 mm



32-561

Forceps (Tissue)

Delicate Right Angle Forceps

CODE	DESCRIPTION	LENGTH
54-7275	Angled, Delicate Jaws, 90°	5¼ in 133 mm
54-7277	Angled, Delicate Jaws, 90°	7¼ in 184 mm



D'Errico Bayonet Tissue Forceps

Bayonet Shape

CODE	TIP WIDTH	TEETH	LENGTH
30-1201	2.4 mm	1x2	8¾ in 222 mm

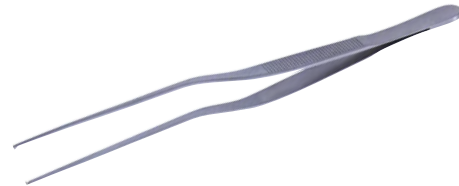

D'Errico Hypophyseal Forceps

Bayonet Shape

CODE	CUP I.D.	WORKING DISTANCE	LENGTH
30-1204	¼ in 6.0 mm	3½ in 89 mm	8⅝ in 219 mm



Duval Lung Forceps

CODE	JAW WIDTH	LENGTH
30-8095	1 in 25 mm	7¾ in 197 mm

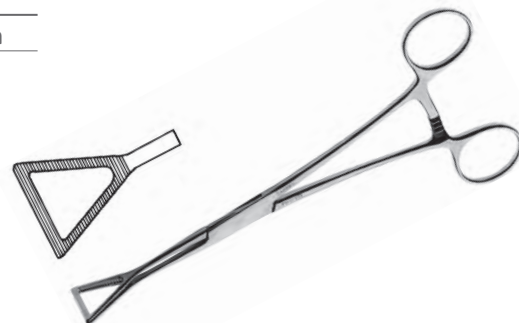

Forceps (Tissue)

Duval Tissue Forceps

Triangular Jaws, Tungsten Carbide Inserts

CODE	JAW WIDTH	LENGTH
36-6055	$\frac{3}{8}$ in 10 mm	$8\frac{1}{4}$ in 210 mm



Duval-Collins Tissue Grasping Forceps

Triangular Jaw

CODE	JAW WIDTH	LENGTH
17-3615	15 mm	$7\frac{1}{2}$ in 191 mm
17-3665	15 mm	9 in 229 mm
17-3620	20 mm	$7\frac{1}{2}$ in 191 mm
17-3650	20 mm	9 in 229 mm
17-3671	25 mm	12 in 305 mm
17-3670	29 mm	9 in 229 mm



Evans Tissue Forceps

CODE	DESCRIPTION	LENGTH
32-550	Tungsten Carbide Inserts Dissector Handle End	10 in 254 mm

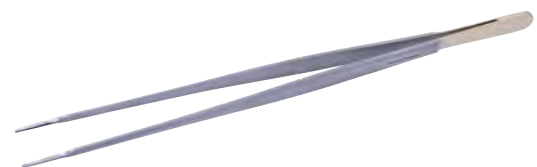

Forceps (Tissue)

Ewald-Hudson Tissue Forceps

CODE	TIP WIDTH	TEETH	LENGTH
30-4216	1.6 mm	1x2	5 in 127 mm



Ferris Smith Tissue Forceps

CODE	TIP WIDTH	TEETH	LENGTH
06-8792		1x2 Teeth	6 $\frac{7}{8}$ in 175 mm
30-1132	3.9 mm	2x3 Teeth	6 $\frac{3}{4}$ in 171 mm
06-8793		2x3 Teeth	6 $\frac{7}{8}$ in 175 mm



Forceps Allis Willauer

Bariatric Forceps

CODE	TEETH	LENGTH
32-3547	3x3 Teeth	14 in 356 mm



Gemini Classic® Delicate Clamp

CODE	DESCRIPTION	LENGTH
30-4492	80° Angle	7 $\frac{1}{4}$ in 184 mm



Forceps (Tissue)

Gemini Mixer Forceps

CODE	DESCRIPTION	LENGTH
54-7262	Curved	14 in 356 mm
54-7255	Right Angle 90°, Delicate Jaws	5½ in 140 mm
54-7256	Right Angle 90°, Delicate Jaws	7¼ in 184 mm
54-7257	Right Angle 90°, Delicate Jaws	8¼ in 210 mm
54-7258	Right Angle 90°, Delicate Jaws	9 in 229 mm
54-7259	Right Angle, Delicate Jaws	11¼ in 286 mm
54-7266	Right Angle 90°	16 in 406 mm



54-7262

Gemini Tissue Forceps

CODE	DESCRIPTION	LENGTH
32-3546	Serrated Tip	14 in 356 mm



Gerald Tissue Forceps

CODE	DESCRIPTION	LENGTH
55-9001	1 x 2 Teeth	7 in 178 mm
32-568	1 x 2 Teeth, Tungsten Carbide Inserts	7 in 178 mm
32-567	1.0 mm Tips, Tungsten Carbide Inserts	9¼ in 235 mm
55-9000	Serrated	7 in 178 mm
55-9004	Serrated	9½ in 241 mm
55-9006	Serrated	14 in 356 mm



55-9000

55-9001

Forceps (Tissue)

Gerald Tissue Forceps

Tungsten Carbide Inserts

CODE	DESCRIPTION	LENGTH
32-570	1.0 mm Tips	7 in 178 mm
32-3531	1.0 mm Tips	7 in 178 mm
32-575	1.0 mm Tips	10 in 254 mm
32-3532	1.0 mm Tips	10 in 254 mm
32-576	1 x 2 Teeth	10 in 254 mm

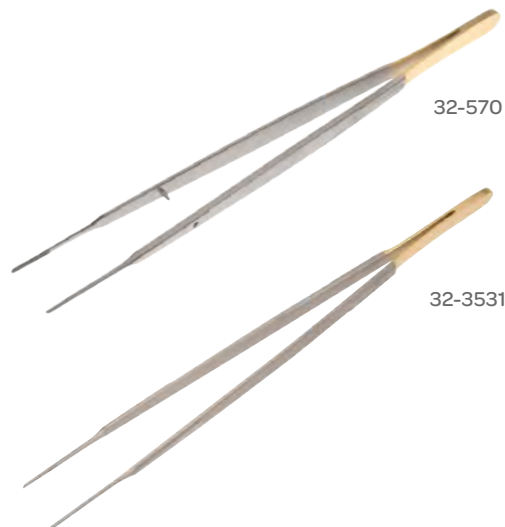

Gerald Tissue Forceps

CODE	DESCRIPTION	LENGTH
55-9048	Cross Serrations	7 ¾ in 197 mm



Gerald Bayonet Tissue Forceps

1 x 2 Teeth

CODE	DESCRIPTION	LENGTH
30-1213	Tip Width 1.3 mm Working Distance: 3 ½ in (89 mm)	7 ½ in 191 mm



Forceps (Tissue)

Gerald Tissue Forceps

Straight

CODE	TIP WIDTH	TEETH	LENGTH
30-1210	1.3 mm	1x2	7 in 178 mm



Gillies Tissue Forceps

CODE	TEETH	LENGTH
06-4085	1x2 Teeth	6 in 152 mm

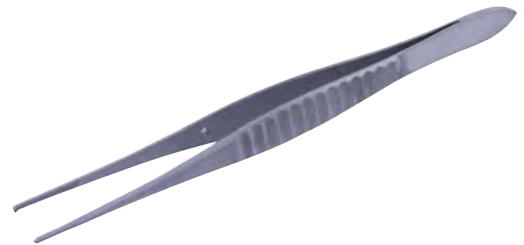

Gorney Adson Forceps

CODE	TEETH	LENGTH
32-505	1x2 Teeth, Diamond-Dusted	4 ¾ in 121 mm



Harrington-Mixer Forceps

Right-Angled Longitudinal Serrations with Cross-Serrated Tips

CODE	DESCRIPTION	LENGTH
30-8051	Thoracic Clamp	12 ¼ in 311 mm



Forceps (Tissue)

Heaney Tissue Forceps

CODE	DESCRIPTION	LENGTH
06-8798	2 x 3 Teeth, Cross-Serrated	5½ in 140 mm



Hoehn Bayonet Tissue Forceps

Guthsch Handle

CODE	DESCRIPTION	LENGTH
30-1166	1 x 2 Teeth, Tip Width 2.1 mm Working Distance: 3 in (76 mm)	7¾ in 197 mm

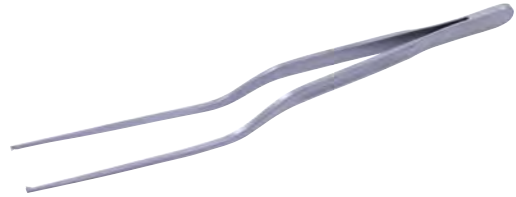

Hoehn Scalp Hemostatic Forceps

CODE	DESCRIPTION	LENGTH
30-1115	Curved on Side, Serrated	5⅝ in 137 mm



Hudson Forceps

CODE	DESCRIPTION	LENGTH
06-2005	1 x 2 Teeth	4¾ in 121 mm



Forceps (Tissue)

Iowa Membrane Puncturing Forceps

CODE	DESCRIPTION	LENGTH
53-1226	5 x 6 Teeth, S-Shaped	10 ¼ in 260 mm



Iris Tissue Forceps

1 x 2 Teeth

CODE	TIP WIDTH	LENGTH
30-6530	0.5 mm, Straight	4 in 108 mm
30-6532	0.5 mm, Curved	4 in 108 mm



Jewelers Forceps

CODE	DESCRIPTION	LENGTH
30-6712	#3, Extra Fine Point	4 ¾ in 121 mm
30-6713	#3C, Extra Fine Point	4 ⅝ in 109 mm
30-6714	#4, Extra Fine Point	4 ¼ in 108 mm
30-6715	#5, Extra Fine Point	4 ⅝ in 109 mm

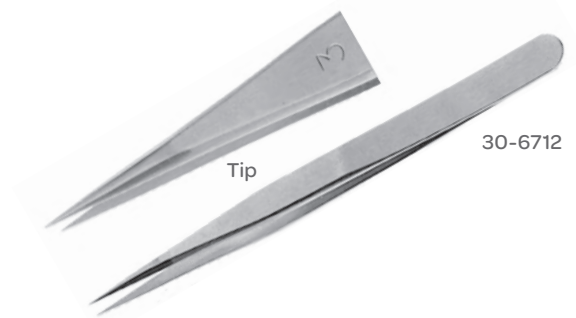

Johns Hopkins Gallbladder Forceps

CODE	DESCRIPTION	LENGTH
30-4297	Curved	8 in 203 mm



Forceps (Tissue)

Judd-Allis Tissue Forceps

CODE	DESCRIPTION	TEETH	LENGTH
50-0665	Narrow Jaws	3 x 4	6 in 152 mm
50-0670	Narrow Jaws	3 x 4	7½ in 191 mm

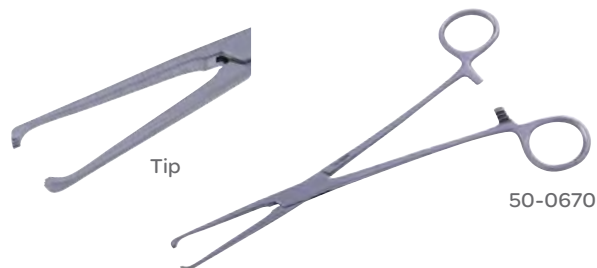

Lahey Hemostatic Forceps

Full Serrations

CODE	DESCRIPTION	LENGTH
30-4020	Straight	5½ in 140 mm
30-4021	Curved	5¾ in 146 mm



Lahey Gallbladder Duct Forceps Cross

CODE	DESCRIPTION	LENGTH
30-4500	Longitudinal Serrations	7½ in 191 mm
30-4502	Longitudinal Serrations	8¾ in 222 mm
30-4501	Horizontal Serrations	7½ in 191 mm



Lawrence Forceps

CODE	DESCRIPTION	LENGTH
54-5006	Jaws Strongly Curved	7¼ in 184 mm
54-5007	Jaws Strongly Curved	11 in 279 mm



Forceps (Tissue)

Lockwood-Allis Tissue Forceps

CODE	TIP WIDTH	TEETH	LENGTH
50-0616		4x5	6 $\frac{1}{8}$ in 156 mm
30-4535	$\frac{3}{16}$ in 5.0 mm	5x6	6 in 152 mm



50-0616

Martin Tissue Forceps

CODE	DESCRIPTION	LENGTH
07-5016	7x8 Teeth	8 in 203 mm
30-4230	6.0 mm Tip	6 in 152 mm
30-4231	6.0 mm Tip	7 in 178 mm



30-4231

Mayo-Russian Tissue Forceps

CODE	DESCRIPTION	TIP WIDTH	LENGTH
30-8112	Fenestrated Jaws	6.0 mm	9 in 229 mm

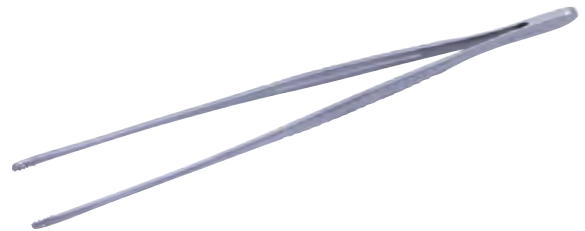

Meeker Forceps

CODE	DESCRIPTION	LENGTH
54-5005	Angled 90°	7 in 178 mm
54-7260	Angled 90°	10 $\frac{3}{4}$ in 273 mm



54-5005

Forceps (Tissue)

Meeker Deep Surgery Forceps

CODE	DESCRIPTION	LENGTH
30-4701	Right Angle	10 ³ / ₄ in 273 mm

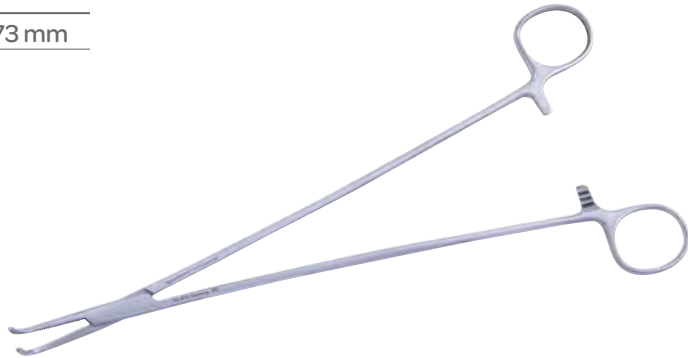

Micro Forceps

CODE	DESCRIPTION	DIAMETER	TIP	LENGTH
78-0045	Straight, Flat Handle	9.0 mm	0.3 mm	4 ¹ / ₄ in 108 mm
78-0070	Straight, Flat Handle	9.0 mm	0.4 mm	4 ¹ / ₄ in 108 mm
78-0060	Straight, Flat Handle	7.0 mm	0.3 mm	5 ¹ / ₄ in 133 mm
78-0055	Straight, Flat Handle	9.0 mm	0.3 mm	5 ¹ / ₄ in 133 mm
78-0075	Straight, Flat Handle	9.0 mm	0.3 mm Pierce	5 ¹ / ₄ in 133 mm
78-0050	Straight, Flat Handle	9.0 mm	0.3 mm w/Platform	5 ¹ / ₂ in 140 mm
78-0047	Straight, Round Handle	8.0 mm	0.3 mm	5 ¹ / ₂ in 140 mm
78-0106	Straight, Counterbalance Handle	8.0 mm	0.6 mm w/Platform	6 in 152 mm
78-0086	Straight			4 ³ / ₄ in 121 mm
78-0025	Round Handle	8.0 mm	0.3 mm	
78-0012	Flat Handle	9.0 mm	0.3 mm	4 ³ / ₄ in 121 mm
78-0065	Angled 45°, Flat Handle	9.0 mm	0.3 mm	4 ¹ / ₄ in 108 mm
78-0040	Angled 45°, Flat Handle	9.0 mm	0.3 mm	5 ¹ / ₄ in 133 mm
78-0142			0.3 mm w/Platform	7 in 178 mm



78-0040

Forceps (Tissue)

Adson (Micro) Tissue Forceps

CODE	DESCRIPTION	LENGTH
06-2312	1x2 Teeth	4 ³ / ₄ in 121 mm
06-2315	1x2 Teeth	6 in 152 mm

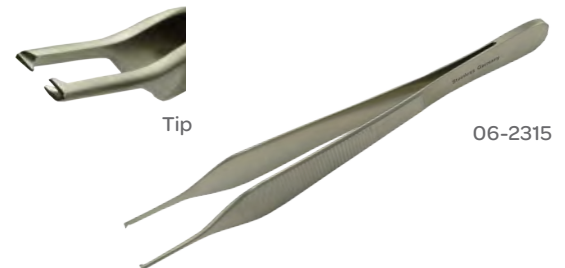

Adson (Micro) Tissue Forceps

CODE	DESCRIPTION	LENGTH
06-2212	Serrated	4 ³ / ₄ in 121 mm
06-2215	Serrated	6 in 152 mm



Mixer Forceps

CODE	DESCRIPTION	LENGTH
17-0723	Right Angled, Delicate	9 ¹ / ₂ in 241 mm



Mixer Right-Angled Forceps

CODE	DESCRIPTION	LENGTH
17-0820	90°	12 in 305 mm
17-0830	90°	14 ¹ / ₂ in 368 mm
17-0840	90°	16 in 406 mm
17-0845	90°	18 in 458 mm
17-1219	Cross-Serrated Tips, Longitudinal Serrations	7 ¹ / ₂ in 191 mm
17-1222	Cross-Serrated Tips, Longitudinal Serrations	8 ¹ / ₂ in 216 mm
17-1225	Cross-Serrated Tips, Longitudinal Serrations	10 in 254 mm
17-1228	Cross-Serrated Tips, Longitudinal Serrations	12 ³ / ₈ in 314 mm

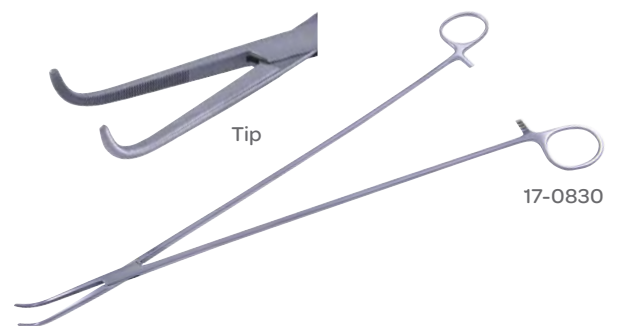

Forceps (Tissue)

Mixer Classic® Delicate Hemostatic Forceps

CODE	DESCRIPTION	LENGTH
30-4485	Right Angle	5½ in 140 mm



Mixer Gall Bladder Forceps

CODE	DESCRIPTION	LENGTH
30-4080	Curved	6¼ in 159 mm
30-4081	Curved	7¼ in 184 mm



30-4080

Needle Forceps

Micro, Tungsten Carbide Inserts

CODE	DESCRIPTION	LENGTH
32-532	1 x 2 Teeth with Serrations	6¼ in 159 mm

Nelson Tissue Forceps

CODE	DESCRIPTION	LENGTH
07-1915	6 x 7 Teeth	6 in 152 mm



Forceps (Tissue)

Nugent Utility Forceps

Smooth, Angled Tip

CODE	TIP WIDTH	LENGTH
30-6695	0.5 mm	4 in 102 mm



Opti-Length® Forceps

General Surgery

CODE	TIP WIDTH	LENGTH
67-7584	2.0 mm	10 in 254mm
67-7586	2.0 mm	12 in 305 mm
67-7585	3.0 mm	10 in 254 mm
67-7587	3.0 mm	12 in 305 mm

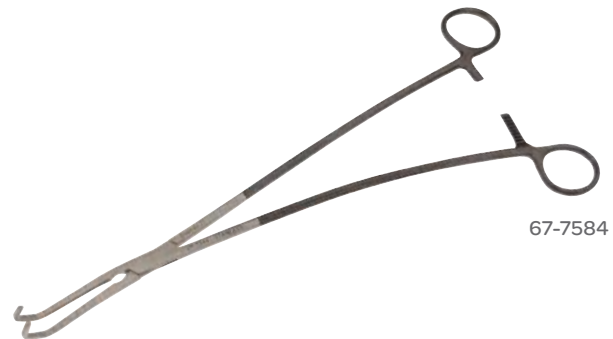

67-7584

Penfield Watchmaker Forceps

CODE	TIP WIDTH	LENGTH
06-1966	0.9 mm	7 in 178 mm
30-1194	0.9 mm	7 in 178 mm



30-1194

Pennington Forceps

Triangular Jaw

CODE	JAW WIDTH	LENGTH
17-3415	12 mm	6 in 152 mm
17-3420	12 mm	8 ½ in 216 mm



17-3415

Forceps (Tissue)

Potts-Smith Tissue Forceps

CODE	DESCRIPTION	LENGTH
32-526	Tungsten Carbide Inserts	7¼ in 184 mm
32-527	Tungsten Carbide Inserts	8 in 203 mm
32-530	Tungsten Carbide Inserts	9 in 229 mm
32-531	Tungsten Carbide Inserts	10 in 254 mm



32-526

Potts-Smith Tissue Forceps

CODE	DESCRIPTION	LENGTH
06-4818	1x2 Teeth	7½ in 181 mm
06-4820	1x2 Teeth	8½ in 216 mm
06-4825	1x2 Teeth	10 in 254 mm
06-4835	1x2 Teeth	12 in 305 mm
06-4838	1x2 Teeth	14 in 356 mm



06-4818

Potts-Smith Tissue Forceps

CODE	DESCRIPTION	TIP WIDTH	LENGTH
30-8023	1x2 Teeth	1.7 mm	7¼ in 184 mm
30-8024	1x2 Teeth	1.7 mm	8¼ in 210 mm

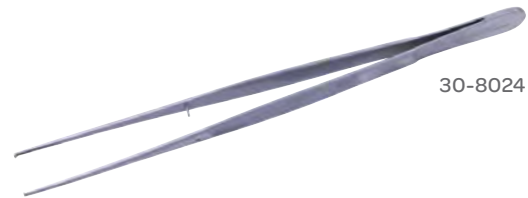

30-8024

Potts-Smith Tissue Forceps

CODE	DESCRIPTION	TIP WIDTH	LENGTH
30-8123	1x2 Teeth	1.8 mm	12 in 305 mm
36-6015	Tungsten Carbide Inserts	1.5 mm	9 in 229 mm

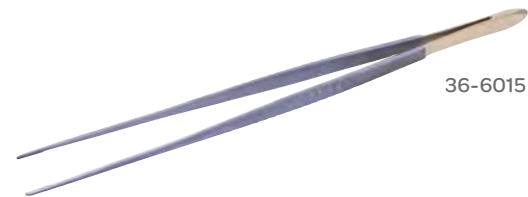

36-6015

Potts-Smith Tissue Forceps

T-Shaped

CODE	TIP WIDTH	LENGTH
30-4095	⅝ in 8.0 mm	6 in 152 mm



Forceps (Tissue)

Raimondi Scalp Forceps

Infant Scalp

CODE	DESCRIPTION	LENGTH
30-1360	1x2 Teeth, Curved on Side	5 in 127 mm

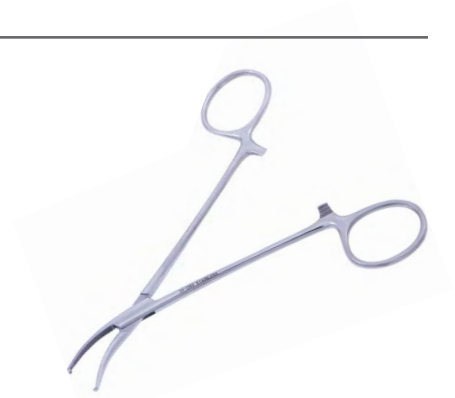

Resano Titanium Vascular Tissue Forceps

CODE	DESCRIPTION	LENGTH
55-2050T	Atraumatic Teeth	9 in 229 mm

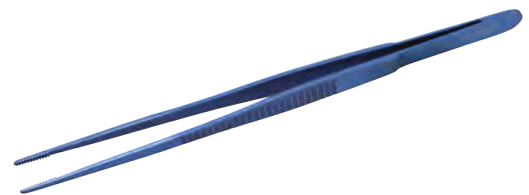

Rhoton® Dural Forceps

CODE	DESCRIPTION	TIP WIDTH	LENGTH
80-1731	1x2 Teeth, Titanium	1.0 mm	7 in 178 mm



Rhoton® Forceps

Titanium

CODE	DESCRIPTION	TIP WIDTH	LENGTH
80-1700	Straight	0.3 mm, Extra Fine	7 in 178 mm
80-1701	Straight	0.7 mm, Fine	7 in 178 mm
80-1702	Bayonet	0.5 mm, Fine	8 ½ in 216 mm
80-1703	Bayonet	1.0 mm, Regular	8 ½ in 216 mm



80-1702

Forceps (Tissue)

Rhoton® Tumor Forceps

Bayonet, Tip Width 4.0 mm, Serrated Ring

CODE	DESCRIPTION	LENGTH
80-1736	Working Distance 3½ in (89 mm) Titanium	8½ in 216 mm
80-1748	Working Distance 3¾ in (95 mm)	9½ in 241 mm



80-1736

Russian Tissue Forceps

CODE	DESCRIPTION	TIP WIDTH	LENGTH
07-1515	Side Grasping Teeth	6 in	152 mm
07-1520	Side Grasping Teeth	8 in	203 mm
07-1525	Side Grasping Teeth	10¼ in	260 mm
07-1530	Side Grasping Teeth	14 in	356 mm
30-4220		6.0 mm	6 in 152 mm
30-4221		7.0 mm	8 in 203 mm
30-4222		7.2 mm	10 in 254 mm



30-4220

Sawtell Forceps

CODE	DESCRIPTION	LENGTH
17-2155	Full Curve, One Open Ring	7½ in 191 mm
17-2156	Full Curve, Closed Rings	7¼ in 184 mm

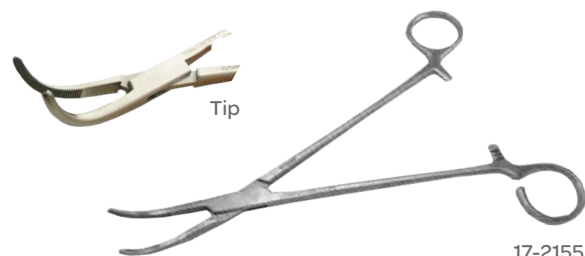

17-2155

Schmidt Forceps

CODE	DESCRIPTION	LENGTH
17-2150	Light Curve, One Open Ring	7½ in 191 mm
17-2151	Light Curve, Closed Rings	7½ in 191 mm
17-2157	Closed Ring	10 in 254 mm

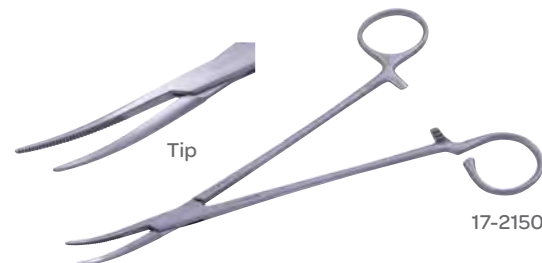

17-2150

Forceps (Tissue)

Seizing Forceps

CODE	DESCRIPTION
14-4805	Ext Forceps Wire

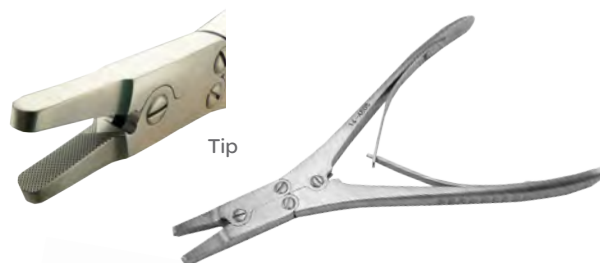

Selman Tissue Forceps

CODE	DESCRIPTION	LENGTH
07-1406	Round Jaws with Teeth	6¼ in 159 mm
07-1410	Round Jaws with Teeth	8¼ in 210 mm



Semken Tissue Forceps

CODE	TIP WIDTH	LENGTH
30-1170	1.3 mm	5 in 127 mm



Semkin Forceps

CODE	DESCRIPTION	LENGTH
06-3115	1x2 Teeth, Straight	6 in 152 mm



Forceps (Tissue)

Singly Intestinal Forceps

CODE	DESCRIPTION	LENGTH
30-4517	Serrated Fenestrated Jaws	9 in 229 mm

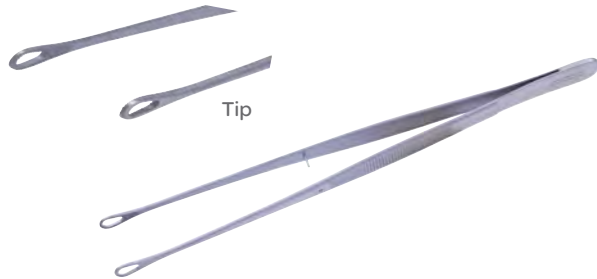

Skinner Needle Forceps

CODE	DESCRIPTION	LENGTH
32-519	1 x 2 Teeth, Tungsten Carbide Inserts	9 in 229 mm
32-521	1 x 2 Teeth, Tungsten Carbide Inserts	9 in 229 mm

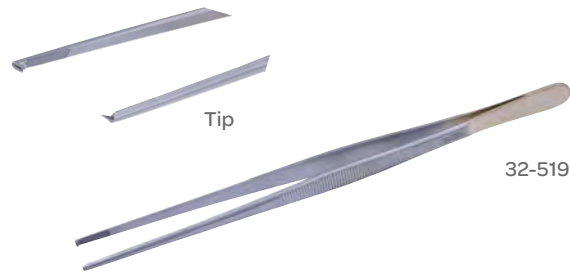

Spetzler Neuro-Vascular Forceps

Bayonet, Titanium, Working Distance 4 in (102 mm)

CODE	DESCRIPTION	TIP WIDTH	LENGTH
80-1905	Straight Tip	0.7 mm	9½ in 241 mm
80-1906	30° Angled Tip	0.7 mm	9½ in 241 mm



Stern-Castroviejo Forceps

CODE	DESCRIPTION	LENGTH
60-1633	Straight, 0.5 mm Teeth with Platform with Lock	4½ in 105 mm



Forceps (Tissue)

Tebbetts-Brown Forceps

CODE	DESCRIPTION	LENGTH
32-508	Tungsten Carbide Inserts	4 ³ / ₄ in 121 mm



Thoms-Allis Tissue Forceps

CODE	DESCRIPTION	LENGTH
50-0520	6 x 7 Teeth	8 in 203 mm
30-4554	Tip Width ¹ / ₄ in (6.0 mm)	8 ¹ / ₂ in 216 mm



30-4554

Thoracic Forceps

CODE	DESCRIPTION	LENGTH
30-8082	Delicately Curved	9 ¹ / ₂ in 241 mm



Tickner Tissue Forceps

CODE	DESCRIPTION	TIP WIDTH	LENGTH
36-6030	Tungsten Carbide Inserts	1.8 mm	6 in 152 mm

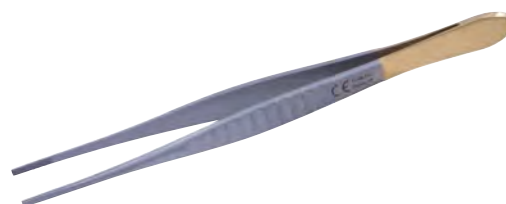

Tissue Forceps

CODE	DESCRIPTION	LENGTH
32-3557	Non-Slip, Round Tip	10 in 254 mm



Forceps (Tissue)

Tissue Forceps

CODE	DESCRIPTION	LENGTH
06-1125	3 x 4 Teeth, Standard Pattern	10 in 254 mm

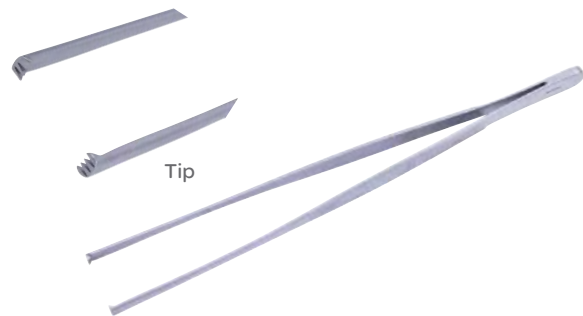

Tissue Forceps

CODE	DESCRIPTION	LENGTH
06-5614	4 x 5 Teeth, Stille-Type	5 in 127 mm



Tissue Forceps

Standard Pattern

CODE	DESCRIPTION	LENGTH
06-0511	1 x 2 Teeth	4 ¾ in 121 mm
06-0513	1 x 2 Teeth	5 in 127 mm
06-0514	1 x 2 Teeth	5 ½ in 140 mm
06-0515	1 x 2 Teeth	6 in 152 mm
06-0518	1 x 2 Teeth	7 in 178 mm
06-0520	1 x 2 Teeth	8 in 203 mm
06-0525	1 x 2 Teeth	10 in 254 mm
06-0530	1 x 2 Teeth	12 in 305 mm
06-0535	1 x 2 Teeth	14 in 356 mm
06-0545	1 x 2 Teeth	18 in 458 mm
06-1013	2 x 3 Teeth	5 ½ in 130 mm
06-1014	2 x 3 Teeth	5 ¾ in 146 mm
06-1016	2 x 3 Teeth	6 ¼ in 159 mm
06-1020	2 x 3 Teeth	8 in 203 mm
06-1113	2 x 3 Teeth	5 ½ in 130 mm
06-1114	2 x 3 Teeth	5 ¾ in 146 mm
06-1116	2 x 3 Teeth	6 ¼ in 159 mm
06-1120	2 x 3 Teeth	8 in 203 mm

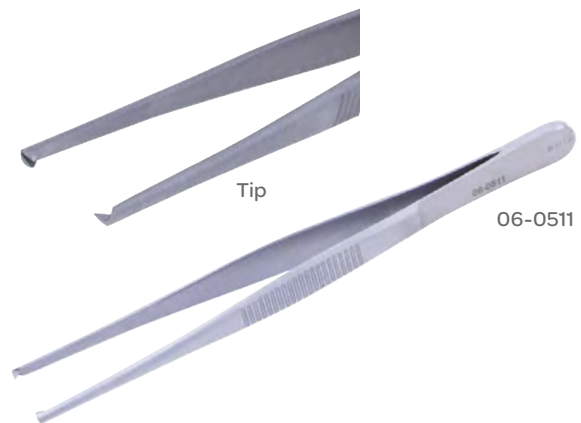

Forceps (Tissue)

Tissue Forceps

CODE	DESCRIPTION	LENGTH
30-4161	2 x 3 Teeth, 3.9 mm Tip	5½ in 140 mm

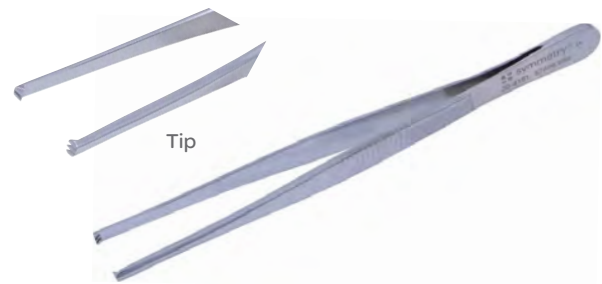

Tissue Forceps

Tungsten Carbide Inserts

CODE	DESCRIPTION	LENGTH
32-514	1 x 2 Teeth	5¾ in 146 mm
32-516	1 x 2 Teeth	6¼ in 159 mm



Tissue Forceps

CODE	TIP WIDTH	LENGTH
67-7582	2.0 mm	8 in 203 mm



Tissue Forceps

1 x 2 Teeth

CODE	TIP WIDTH	LENGTH
30-4151	2.3 mm	5 in 127 mm
30-4152	2.3 mm	5½ in 140 mm
30-4153	2.3 mm	6 in 152 mm
30-4155	3.0 mm	8 in 203 mm
30-4156	3.1 mm	10 in 254 mm
30-4157	3.9 mm	12 in 305 mm



Forceps (Tissue)

Tissue Forceps MagnaFree®

Non-Magnetic, Titanium

CODE	DESCRIPTION	TIP	LENGTH
65-2420	2x3 teeth	3.9 mm	5½ in 140 mm



Tuttle (Singley) Tissue Forceps

CODE	DESCRIPTION	LENGTH
07-1718	Tissue Forceps	7½ in 181 mm
07-1723	Tissue Forceps	9 in 229 mm
07-1724	Tissue Forceps	14 in 356 mm
07-1728	Tissue Forceps	18 in 458 mm

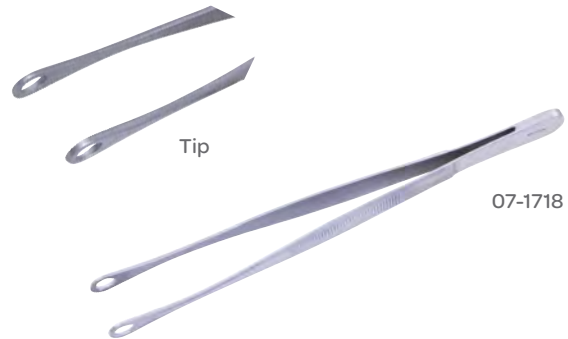

Varco Gall Bladder Forceps Slight Curve

CODE	DESCRIPTION	LENGTH
30-4652	Slightly Curved	7½ in 191 mm

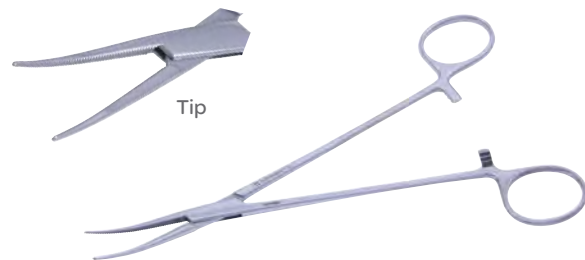

Von Graefe Fixation Forceps

CODE	DESCRIPTION	TIP WIDTH	LENGTH
30-6585	No Teeth	2.0 mm	4¾ in 121 mm



Forceps (Tissue)

Wangensteen Tissue Forceps

CODE	DESCRIPTION	LENGTH
32-535	Serrated, Tungsten Carbide Inserts	9 in 229 mm

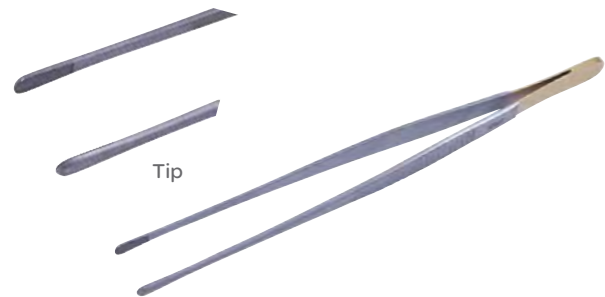

Waugh Tissue Forceps

CODE	DESCRIPTION	TEETH	LENGTH
06-4215	Serrated		6 in 152 mm
06-4220	Serrated		8 in 203 mm
06-4315		1x2	6 in 152 mm



Willauer-Allis Tissue Forceps

CODE	DESCRIPTION	LENGTH
30-8085	Curved	10 in 254 mm



Williams Tissue Forceps

CODE	DESCRIPTION	LENGTH
50-0816	Straight	6½ in 165 mm

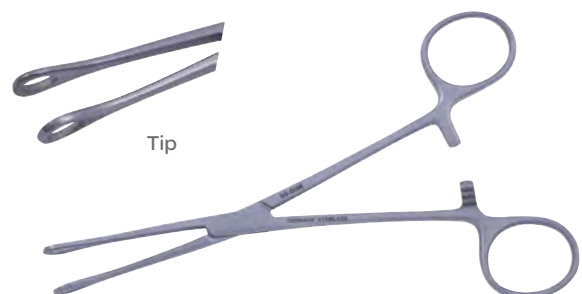

Forceps (Tissue-Tying)

Callison Tissue-Tying Forceps

Tying Platform

CODE	DESCRIPTION	LENGTH
06-2590	1 x 2 Teeth, 1.5 mm Teeth	4 $\frac{7}{8}$ in 124 mm

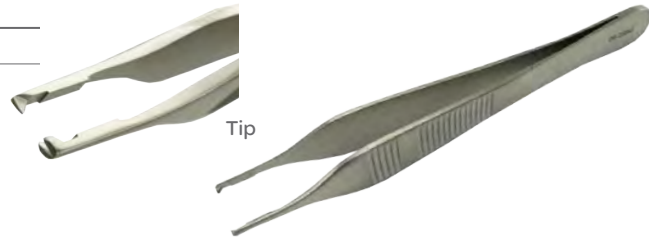

Forceps (Titanium)

Adson MagnaFree® Tissue Forceps

Titanium, Non-Magnetic

CODE	DESCRIPTION	LENGTH
65-2413	1 x 2 Teeth	5 in 127 mm



Adson Titanium Dressing Forceps

CODE	DESCRIPTION	LENGTH
06-2012T	Serrated Jaws	4 $\frac{3}{4}$ in 121 mm
06-2112T	1 x 2 Teeth	4 $\frac{3}{4}$ in 121 mm

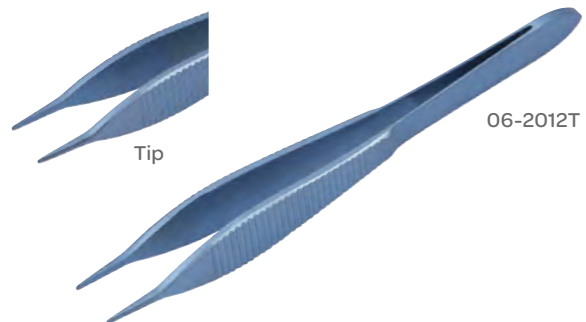

DeBakey Titanium Vascular Tissue Forceps

DeBakey Teeth, Titanium

CODE	DESCRIPTION	LENGTH
55-2004T	1.0 mm Tips	6 in 152 mm
55-2005T	1.0 mm Tips	7 $\frac{3}{4}$ in 197 mm
55-2008T	2.0 mm Tips	7 $\frac{3}{4}$ in 197 mm
55-2009T	2.0 mm Tips	9 $\frac{1}{2}$ in 241 mm
55-2007T	2.0 mm Tips	6 in 152 mm

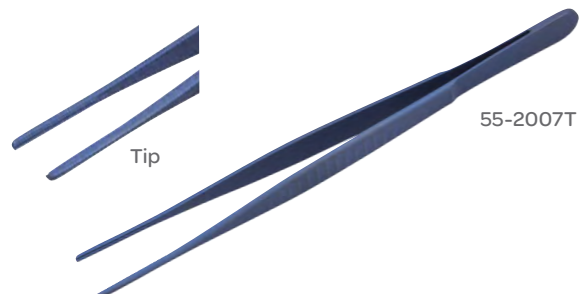

Forceps (Titanium)

Forceps

Straight, Titanium

CODE	DESCRIPTION	TIP WIDTH	LENGTH	
80-6631	Extra Fine Utility	0.3 mm	6 in	152 mm
80-6630	Extra Fine Tying Tip	0.7 mm	6 in	152 mm
80-6001	Ring Tip, Closing Pressure (Appx.) 50 Grams	1.0 mm	6 in	152 mm
80-6002	Ring Tip, Serrated, Closing Pressure (Appx.) 50 Grams	1.0 mm	6 in	152 mm



MagnaFree® Crile Forceps

Delicate

CODE	DESCRIPTION	LENGTH	
65-2418	Straight, Titanium	5½ in	140 mm
65-2419	Curved, Titanium	5½ in	140 mm



MagnaFree® Dressing Forceps

Non-Magnetic for Interventional MRI

CODE	DESCRIPTION	TIP	LENGTH	
65-2407	Serrated, Titanium	3.0 mm	10 in	254 mm



Forceps

MagnaFree® Sponge Forceps

CODE	DESCRIPTION	LENGTH
65-2415	Straight, Serrated Jaws, Titanium, Non Magnets	9½ in 241 mm

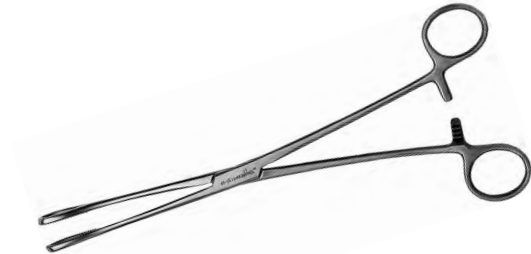

Forceps (Tongue)

Collin Tongue Forceps

CODE	DESCRIPTION	LENGTH
30-4330	Seizing Forceps	6½ in 165 mm



Forceps (Tonsil)

Schmidt Forceps

CODE	DESCRIPTION	LENGTH
17-2154	Full Curve, Closed Rings	14 in 356 mm

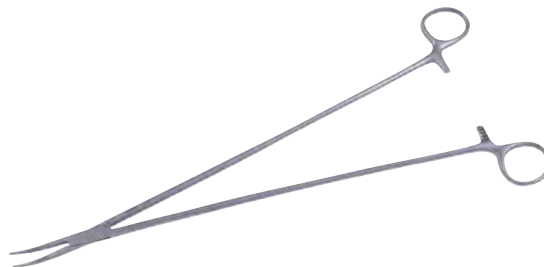

White Tonsil Forceps

CODE	DESCRIPTION	LENGTH
30-7315	Seizing Forceps	7 in 178 mm



Forceps (Tracheal Tenaculum)

Jackson Tracheal Hook Tenaculum Forceps

CODE	DESCRIPTION	LENGTH
20-4014	1 Prong, Sharp	5 $\frac{3}{4}$ in 146 mm



Forceps (Tying)

Jaffe Tying Forceps

Smooth Tips, Very Delicate with Platform

CODE	DESCRIPTION	LENGTH
60-1608	Straight	4 in 102 mm
60-1609	Curved	4 in 102 mm



Forceps (Uterine)

Bozeman Uterine Dressing Forceps

CODE	DESCRIPTION	LENGTH
30-5561	Curved Shafts and Shanks	10 in 254 mm



Jacobs Uterine Vulsellum Forceps

CODE	DESCRIPTION	LENGTH
30-5605	2 x 2 Teeth	8 in 203 mm



Forceps (Uterine)

Phaneuf Uterine Artery Forceps

CODE	DESCRIPTION	LENGTH
30-5536	1 x 2 Teeth, Angled	8 ¼ in 210 mm

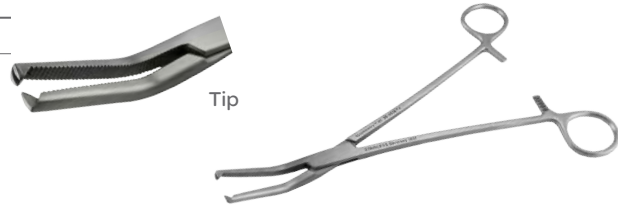

Schroeder Uterine Tenaculum Forceps

CODE	DESCRIPTION	LENGTH
30-5580	1 x 1 Sharp Teeth, Straight	8 ¾ in 222 mm



Schroeder Uterine Vulsellum Forceps

CODE	DESCRIPTION	LENGTH
30-5595	2 x 2 Sharp Teeth	9 in 229 mm



Teale Uterine Vulsellum Forceps

CODE	DESCRIPTION	LENGTH
30-5615	4 x 5 Sharp Teeth, Curved on Side	10 ⅞ in 257 mm



Forceps (Vascular)

Cooley Vascular Forceps

CODE	DESCRIPTION	LENGTH	
55-2026	1.0 mm, Cross-Serrated Tip	8 in	203 mm
55-2027	1.0 mm, Cross-Serrated Tip	12 in	305 mm

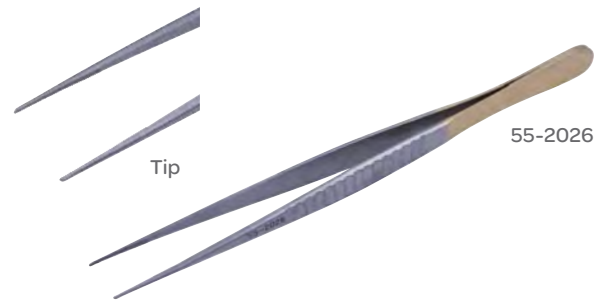

Cooley Vascular Tissue Forceps

CODE	DESCRIPTION	LENGTH	
55-2022	Cooley Teeth	6 in	152 mm
55-2023	Cooley Teeth	8 in	203 mm
55-2024	Cooley Teeth	9½ in	241 mm

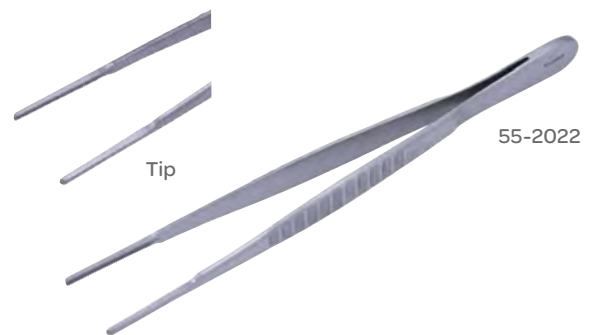

Forceps (Vascular)



Daicoff Vascular & Needle Pulling Forceps

Tungsten Carbide Inserts, Serration Length $1\frac{1}{16}$ in (17 mm)

CODE	DESCRIPTION	TIP WIDTH	TOOTH LENGTH	LENGTH
30-8015	1 x 2 Vascular Teeth	2.0 mm	0.8 mm	7 $\frac{3}{4}$ in 197 mm

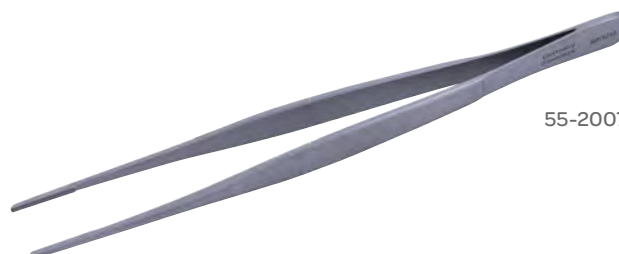

55-2007

DeBakey Vascular Tissue Forceps

CODE	DESCRIPTION	TIP WIDTH	LENGTH
55-2000	Straight Tips	2.0 mm	7 in 178 mm
55-2007	Fluted Handle	2.0 mm	6 in 152 mm
55-2008	Fluted Handle	2.0 mm	7 $\frac{3}{4}$ in 197 mm
55-2009	Fluted Handle	2.0 mm	9 $\frac{1}{2}$ in 241 mm
55-2010	Fluted Handle	2.0 mm	12 in 305 mm
55-2030	Fluted Handle	2.0 mm	14 in 356 mm
55-2040	Fluted Handle	2.0 mm	16 in 406 mm
55-2015	Angled Tips	2.0 mm	7 $\frac{3}{4}$ in 197 mm
55-2016	Angled Tips	2.0 mm	9 $\frac{1}{2}$ in 241 mm
55-2017	Angled Tips	2.0 mm	11 $\frac{3}{4}$ in 298 mm
55-2018	Fluted Handle with Shoulders	3.0 mm	6 in 152 mm
55-2019	Fluted Handle with Shoulders	3.0 mm	7 $\frac{3}{4}$ in 197 mm
55-2020	Fluted Handle with Shoulders	3.0 mm	9 $\frac{1}{2}$ in 241 mm
55-2021	Fluted Handle with Shoulders	3.0 mm	12 in 305 mm
55-2065	Fluted Handle with Shoulders	3.0 mm	14 in 356 mm
55-2075	Fluted Handle with Shoulders	3.0 mm	16 in 406 mm

Forceps (Vascular)

DeBakey Vascular Tissue Forceps

CODE	TIP WIDTH	LENGTH
67-7801	2.0 mm	12 in 305 mm
67-7803	2.0 mm	14 in 356 mm



67-7801

DeBakey Dietrich Vascular Tissue Forceps

DeBakey Teeth, Serrated Handle

CODE	TIP WIDTH	LENGTH
55-2004	1.0 mm	6 in 152 mm
55-2005	1.0 mm	7¾ in 197 mm
55-2006	1.0 mm	9½ in 241 mm

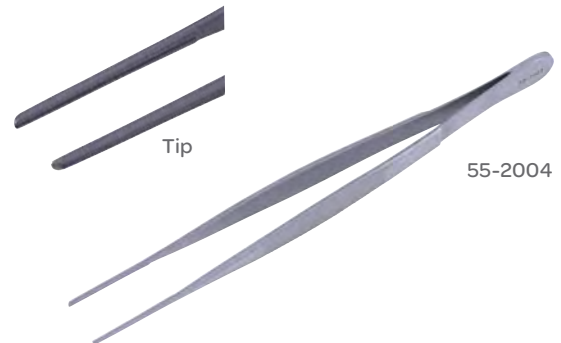

55-2004

DeBakey Dietrich Vascular Tissue Forceps

CODE	DESCRIPTION	LENGTH
30-8131	Tip Tapers From 1.5–1.3 mm	6 in 152 mm
30-8132	Tips Taper From 1.5–1.3 mm	7¾ in 197 mm
30-8133	Tips Taper From 1.5–1.3 mm	9½ in 241 mm

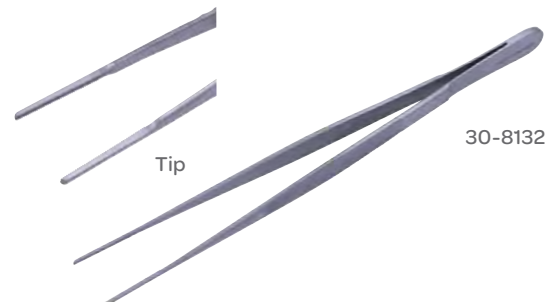

30-8132

DeBakey Opti-Length® Forceps

CODE	TIP WIDTH	LENGTH
67-7800	1.5 mm	12 in 305 mm
67-7802	1.5 mm	14 in 356 mm



67-7800

Forceps (Vascular)

DeBakey Thoracic Tissue Forceps

CODE	DESCRIPTION	LENGTH
32-3550	Tissue Forceps	14 in 356 mm



DeBakey Tissue Forceps

CODE	TIPS	LENGTH
37-1000	3.0 mm Tips	6 in 152 mm
37-1001	3.0 mm Tips	7 ³ / ₄ in 197 mm
37-1002	3.0 mm Tips	9 ¹ / ₂ in 241 mm
37-1003	3.0 mm Tips	12 in 305 mm

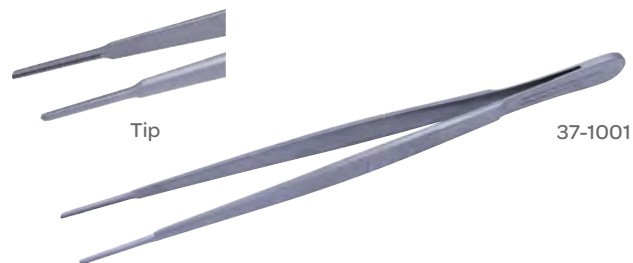

DeBakey Vascular Forceps

CODE	DESCRIPTION	LENGTH
37-1010	2.0 mm Tips	6 in 152 mm
37-1011	2.0 mm Tips	7 ³ / ₄ in 197 mm
37-1012	2.0 mm Tips	9 ¹ / ₂ in 241 mm
37-1013	2.0 mm Tips	12 in 305 mm



DeBakey-Liddicoat Vascular Forceps

Straight, 1 x 2 Vascular Teeth, Titanium

CODE	TIP WIDTH	LENGTH
30-8400	1.8 mm	6 in 152 mm
30-8401	1.8 mm	6 in 152 mm
30-8402	1.8 mm	7 ³ / ₄ in 197 mm
30-8403	1.8 mm	7 ³ / ₄ in 197 mm
30-8404	1.8 mm	9 ¹ / ₂ in 241 mm
30-8405	2.25 mm	9 ¹ / ₂ in 241 mm

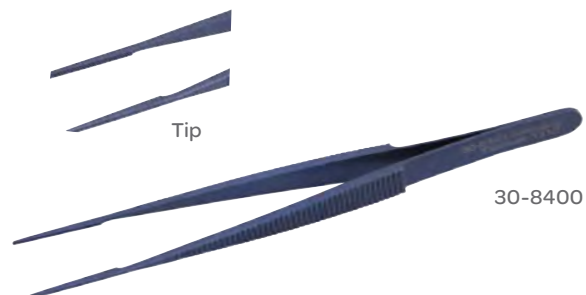

Forceps (Vasectomy)

Sanders Vasectomy Forceps

CODE	DESCRIPTION	LENGTH
51-8001	1x1 Prongs	6 $\frac{1}{8}$ in 156 mm



Vasectomy No Scalpel Hemostatic Forceps

CODE	DESCRIPTION	LENGTH
51-8004	Circular Jaws	6 $\frac{1}{4}$ in 159 mm



Goniometers (Finger Goniometer)

Pollock Finger Goniometer

CODE	DESCRIPTION	LENGTH
44-3830	Finger Goniometer	6 in 152 mm



Hammers

Taylor Percussion Hammer

CODE	DESCRIPTION	LENGTH
88-4000	Percussion Hammer	8 in 203 mm



Hooks (Double Hook)

Fixation Double Hook

2 Prongs, Sharp

CODE	TIP WIDTH	LENGTH
60-1298	1.5 mm	5 1/8 in 130 mm
60-1299	2.0 mm	5 1/8 in 130 mm



Freer Double Hook

CODE	TIP WIDTH	LENGTH
20-5202	3.0 mm, Sharp	6 in 152 mm

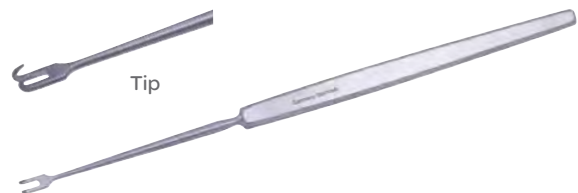

Hooks (Double Hook)

Joseph Nasal Double-Prong Hook

CODE	TIP WIDTH	LENGTH
38-6645	$\frac{1}{16}$ in 2.0 mm	6 $\frac{1}{4}$ in 159 mm
38-6646	$\frac{3}{16}$ in 5.0 mm	6 $\frac{1}{4}$ in 159 mm
38-6647	$\frac{1}{4}$ in 6.0 mm	6 $\frac{1}{4}$ in 159 mm
38-6648	$\frac{3}{8}$ in 10 mm	6 $\frac{1}{4}$ in 159 mm



38-6648

Joseph Skin Hook

Sharp

CODE	TIP WIDTH	LENGTH
20-5002	$\frac{1}{16}$ in 2.0 mm	6 $\frac{1}{4}$ in 159 mm
20-5005	$\frac{3}{16}$ in 5.0 mm	6 $\frac{1}{4}$ in 159 mm
20-5007	$\frac{1}{4}$ in 6.0 mm	6 $\frac{1}{4}$ in 159 mm
20-5010	$\frac{3}{8}$ in 10 mm	6 $\frac{1}{4}$ in 159 mm



20-5002

Meyerding Finger Hook-Retractor

With Skin Hook, Double Ended

CODE	DESCRIPTION	LENGTH
50-4485	Blade Width $\frac{3}{16}$ in (5.0 mm) Blade Depth $\frac{5}{8}$ in (16 mm) Hook Depth $\frac{3}{8}$ in (10 mm)	6 $\frac{1}{4}$ in 159 mm



Smithwick Neck Hook-Dissector

Blunt, Double Ended

CODE	DESCRIPTION	LENGTH
38-1088	Tip Diameter (0.02 mm) Hook Length $\frac{7}{16}$ in (11 mm)	12 in 305 mm



Hooks (Dura)

Tracheal Hook

CODE	DESCRIPTION	LENGTH
20-6502	Double Prong, Blunt	6¼ in 159 mm



Adson Dura Hook

CODE	DESCRIPTION	LENGTH
20-2722	1 Prong, Sharp	8 in 203 mm
20-2723	1 Prong, Blunt	8 in 203 mm
20-2723E	Blunt, Ebonized	8 in 203 mm

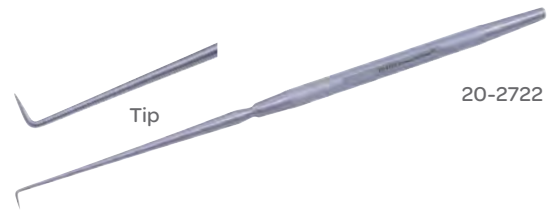

Hooks

Chamberlain-Fries Hook

CODE	DESCRIPTION	LENGTH
20-2040	Single	6½ in 165 mm



Hook

CODE	DESCRIPTION
20-5012	Hook Single Prong, Large, Sharp



Hooks (Nerve Hook)

Adson Dura Hook

1 Prong, Blunt

CODE	TIP WIDTH	LENGTH
20-2057	7.0 mm	6¼ in 159 mm



Hooks (Nerve)

Cushing Nerve Hook

Ball Tip

CODE	TIP WIDTH	LENGTH
20-2231	4.0 mm	7½ in 191 mm
20-2232	6.0 mm	7½ in 191 mm
20-2236	6.0 mm	11 in 279 mm

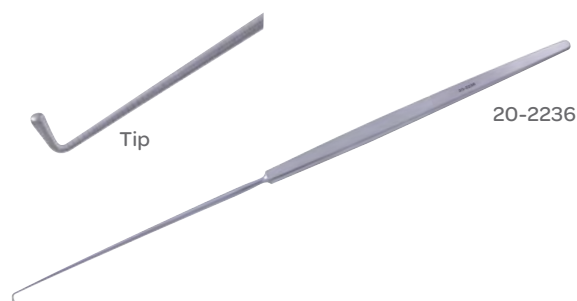

Lucae Nerve Hook

Probe Tip

CODE	DESCRIPTION	LENGTH
20-2201	Small	5½ in 140 mm
20-2202	Medium	5½ in 140 mm
20-2203	Large	5½ in 140 mm

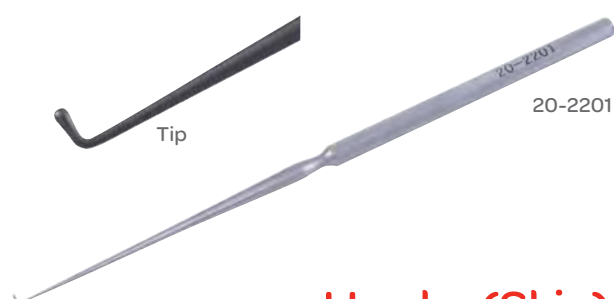

Hooks (Skin)

Barsky Skin Hook

CODE	DESCRIPTION	LENGTH
20-3501	1 Prong, Sharp	6 in 152 mm

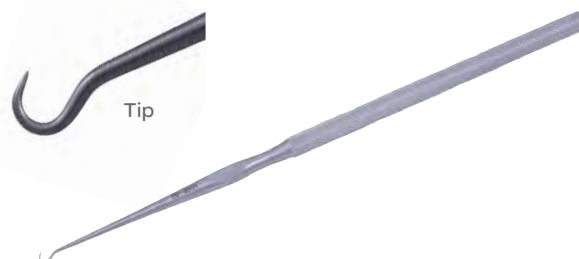

Frazier Skin Hook

CODE	DESCRIPTION	LENGTH
20-3012	1 Prong, Small, Sharp	5 in 127 mm



Hooks (Skin)

Gilles Skin Hook

1 Prong, Sharp

CODE	TIP WIDTH	LENGTH
20-3019	3.0 mm, Small	7 in 178 mm
20-3020	4.0 mm, Large	7½ in 191 mm



Guthrie Skin Hook

1 Prong, Sharp

CODE	TIP WIDTH	LENGTH
20-5210	1.5 mm	5⅛ in 130 mm
20-5211	2.0 mm	5⅛ in 130 mm



Joseph Skin Hook

1 Prong, Sharp

CODE	TIP WIDTH	LENGTH
20-5001	4.0 mm	6¼ in 159 mm



Kilner Skin Hook

CODE	DESCRIPTION	LENGTH
20-5109	Skin Hook	5 in 127 mm



Hooks (Skin Hook)

Kleinert-Kutz Skin Hook

1 Prong, Sharp

CODE	DESCRIPTION	LENGTH
20-4803	#1, 3.0 mm	5 1/8 in 130 mm
20-4805	#2, 5.0 mm	5 1/8 in 130 mm
20-4807	#3, 7.0 mm	5 1/8 in 130 mm



Straight Skin Hook

CODE	DESCRIPTION	LENGTH
20-3113	1 Prong, Sharp	5 1/8 in 130 mm



Hooks (Swivel)

Humby Swivel Skin Hook

CODE	DESCRIPTION	LENGTH
20-3532	Sharp	4 1/2 in 114 mm



Hooks (Tracheal Retractor)

Tracheal Retractor

CODE	DESCRIPTION	LENGTH
20-6402	2 Prongs, Sharp	6 1/4 in 159 mm



Hooks (Tracheal Retractor)

Converse Skin Hook

Sharp

CODE	HOOK SIZE			LENGTH	
38-6638	1/8 in	3.0 mm	Small	7 1/4 in	184 mm
38-6640	1/5 in	5.0 mm	Large	7 1/4 in	184 mm



38-6638

Gilles Skin Hook

Sharp

CODE	HOOK SIZE			LENGTH	
38-2520	1/5 in	3.0 mm		7 1/8 in	181 mm



Guthrie Eye Fixation Hook

Standard

CODE	TIP WIDTH	LENGTH	
38-6530	2.0 mm	4 3/4 in	121 mm



Guthrie Fixation Hook Del

Delicate

CODE	TIP WIDTH	LENGTH	
38-6531	1.0 mm	5 1/4 in	133 mm



Hooks (Tracheal Retractor)

Joseph Single Prong Nasal Hook

CODE	DESCRIPTION	LENGTH
38-6642	Single Prong Nasal Hook	6¼ in 159 mm



Tyrell Iris Hook

CODE	TIP WIDTH	LENGTH
38-6525	0.4 mm, Sharp	4¾ in 121 mm



Knives (Golf Stick)

Golf Stick Knife

CODE	DESCRIPTION
43-4043	Stick Knife



Knife Handles

Corwin Knife Handle

CODE	DESCRIPTION	LENGTH
01-2740	Knife Handle	6¼ in 159 mm



Knife Handles

Javelin Micro-Knife Handles

Working Distance $4\frac{2}{3}$ in (117 mm), Handle Diameter $\frac{3}{11}$ in (7 mm)

CODE	DESCRIPTION	LENGTH
46-3177	2.0 mm Micro Tip	9 in 229 mm
46-3178	1.5 mm Ultra Tip	9 in 229 mm

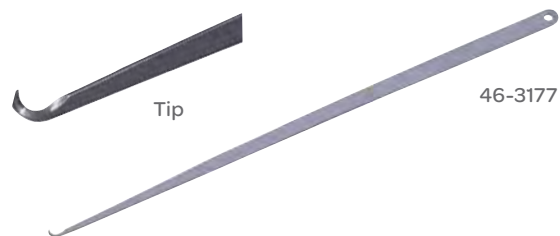

Kaye Knife Handle

CODE	DESCRIPTION	LENGTH
01-6708	Lightweight (For BP Blades 10-15)	$6\frac{1}{8}$ in 156 mm



Knife Handle

CODE	DESCRIPTION	LENGTH
01-2003	Octagonal	$5\frac{1}{4}$ in 133 mm



Knife Handle

CODE	DESCRIPTION	LENGTH
01-2723	#3LA, Angled	$8\frac{3}{8}$ in 213 mm
01-2713	#3L, Long	$8\frac{3}{8}$ in 213 mm
01-2703	#3, Standard	5 in 127 mm
01-2733	#3, Standard	12 in 305 mm
01-2746	#3, Standard	16 in 406 mm



Knife Handles

Knife Handle

CODE	DESCRIPTION	LENGTH
01-2707	#7, Standard	6½ in 165 mm
01-2708	#7, Standard	9 in 229 mm



01-2708

Knife Handle

CODE	DESCRIPTION	LENGTH
01-2709	#9, Standard	5 in 127 mm



Knife Handle

CODE	DESCRIPTION	LENGTH
01-2804	#4, Standard	5¼ in 133 mm
01-2814	#4L, Long	8¾ in 213 mm



01-2804

Knife Handle

CODE	DESCRIPTION	LENGTH
01-2850	Round (3K)	4 in 102 mm

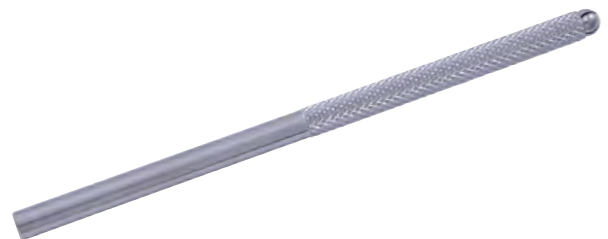

Knife Handles

Knife Handle

CODE	DESCRIPTION	LENGTH
01-3032L	Round	6¼ in 159 mm



Knife Handle

CODE	DESCRIPTION	LENGTH
01-3034	Hexagonal	4 in 102 mm
01-3036	Hexagonal	6 in 152 mm



01-3034

Knife Handle

CODE	DESCRIPTION	LENGTH
11-5530	#3	4⅞ in 124 mm
11-5531	#4	5¼ in 133 mm
11-5534	#7	6¼ in 159 mm
11-5535	#3 Long	8⅜ in 213 mm



11-5531

Markers (Surgical)

Surgical Marker

Gentian Violet Dye, Sterile, Disposable, Packaged with 6 inch Ruler

CODE	DESCRIPTION	QTY
43-1030	Regular Tip	36/Box
43-1032	Micro Tip	36/Box



Nail Nippers

Nail Nipper

CODE	DESCRIPTION	LENGTH
43-7081	Sharp End, Concave Jaw	5½ in 140 mm



Nail Nipper

CODE	DESCRIPTION	LENGTH
43-7082	Barrel Spring, Concave Jaw	4½ in 114 mm
43-7083	Barrel Spring, Concave Jaw	5½ in 140 mm

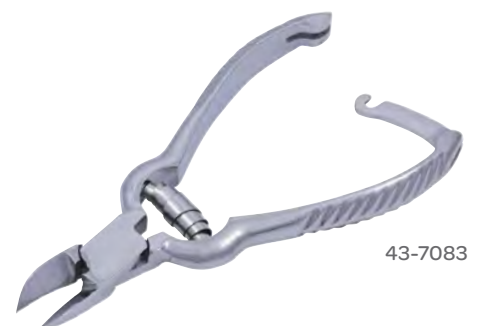

Nail Nippers

Nail Nipper

CODE	DESCRIPTION	LENGTH
43-7313	Stainless Steel, Straight Jaw	5 in 127 mm



Nail Nipper

CODE	DESCRIPTION	LENGTH
43-7514	Double Spring, Concave Jaw	5½ in 140 mm
43-7515	Double Spring, Straight Jaw	5½ in 140 mm



43-7514

Nail Nipper

CODE	DESCRIPTION	LENGTH
43-7592	7/16 in 11 mm	4½ in 114 mm



Nail Nipper

CODE	DESCRIPTION	LENGTH
43-7810	Straight Jaw, Double Spring	4 in 102 mm



Nail Nippers

Mycotic Nail Nipper

CODE	DESCRIPTION	LENGTH
43-0446	Double Action, Barrel Spring	6 in 152 mm

Nail Nippers (Tissue & Cuticle)

Tissue & Cuticle Nipper

CODE	DESCRIPTION	LENGTH
43-7594	Convex Jaw	5 in 127 mm



Nail Nippers

Nail Nipper

CODE	DESCRIPTION	LENGTH
43-7914	English Anvil, Double Spring	5 in 127 mm



Nail Nipper

Curved Back, Straight Jaws

CODE	DESCRIPTION	LENGTH
43-7813	Stainless Steel	4 in 102 mm
43-7812	Heavy Pattern	4 in 102 mm



43-7813

Nail Splitters

Nail Splitter

Straight, Single End

CODE	DESCRIPTION	LENGTH
43-0557	Small Blade	5 in 127 mm
43-0560	Large Blade	5 in 127 mm



43-0557

Needle Holders (Combination with Scissor)

Gillies Needle Holder & Scissor Holder

CODE	DESCRIPTION	LENGTH
32-425	Tungsten Carbide Inserts, Use with 2-0, 3-0 Suture	6½ in 165 mm



Needle Holders (Double Action)

Double Action Needle Holder

Jaw Surface with Fine Tungsten Carbide Dust, Use with 5-0, 6-0 and 7-0 Suture, Round Handle

CODE	DESCRIPTION	LENGTH
55-2604	Straight without Lock	7¼ in 184 mm
55-2612	Straight without Lock	9 in 229 mm
55-2610	Straight with Lock	9 in 229 mm
55-2608	Curved without Lock	7¼ in 184 mm

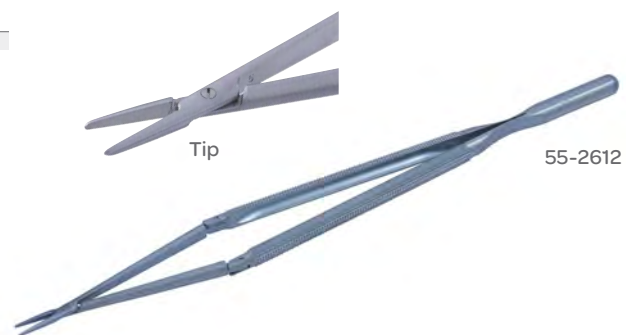

55-2612

Needle Holders (Micro)

Castroviejo (Jacobson Style) Heavy Needle Holder

Straight, Tungsten Carbide Inserts, Use with 1-0, 2-0, 3-0 Suture, Serrated Jaws

CODE	DESCRIPTION	LENGTH
32-449	Flat Handle with Lock	7¼ in 184 mm
32-439	Flat Handle with Lock	8¼ in 210 mm



Jacobson Heavy Needle Holder

Straight, use with 1-0, 2-0 and 3-0 Suture, Round Handle, with Lock

CODE	DESCRIPTION	LENGTH
32-470	Tungsten Carbide Inserts	7¾ in 197 mm
32-471	Tungsten Carbide Inserts	9¼ in 235 mm
32-473	Tungsten Carbide Inserts	10 in 254 mm



Needle Holders (Micro)

Double Action Titanium Needle Holder

Jaw Surfaces with Tungsten Carbide Dust

CODE	DESCRIPTION	LENGTH
55-2612T	Straight	9 in 229 mm



Needle Holders (Micro)

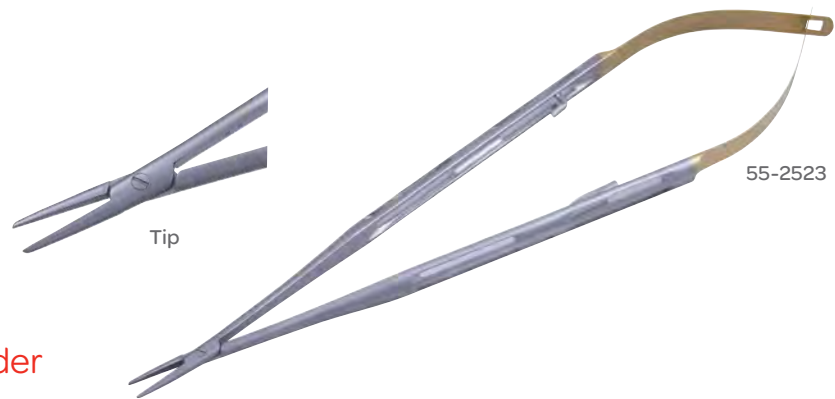

Jacobson Micro Needle Holder

Tungsten Carbide Inserts, Straight

CODE	TIP	HANDLE	LENGTH
32-480	Smooth, Use with 4-0, 5-0 and 6-0 Suture	Flat Handle with Lock	7 in 178 mm
32-488	Serrated, Use with 3-0 and 4-0 Suture	Round Handle without Lock	7¼ in 184 mm
32-492	Serrated, Use with 3-0 and 4-0 Suture	Round Handle without Lock	8¼ in 210 mm
32-493	Serrated, Use with 3-0 and 4-0 Suture	Round Handle without Lock	9 in 229 mm

Jacobson Micro Needle Holder

Tungsten Carbide Dust Jaws, Straight, Round Handle with Short Knurling

CODE	TIP	HANDLE	LENGTH
55-2527	Delicate Tips, Use with 7-0 and 8-0 Suture	With Lock	8¼ in 210 mm
55-2531	Delicate Tips, Use with 7-0 and 8-0 Suture	With Lock	9 in 229 mm
55-2528	Delicate Tips, Use with 7-0 and 8-0 Suture	Without Lock	8¼ in 210 mm
55-2532	Delicate Tips, Use with 7-0 and 8-0 Suture	Without Lock	9 in 229 mm

Jacobson Micro Needle Holder

Tungsten Carbide Dust Jaws, Round Handle

CODE	TIP	HANDLE	LENGTH
55-2523	Straight, Use with 5-0, 6-0 and 7-0 Suture	With Lock	7¼ in 184 mm
55-2525	Straight, Use with 5-0, 6-0 and 7-0 Suture	With Lock	8¼ in 210 mm
55-2536	Straight, Use with 5-0, 6-0 and 7-0 Suture	With Lock	9¼ in 235 mm
55-2423	Curved, Use with 5-0, 6-0 and 7-0 Suture	With Lock	7¼ in 184 mm

Jacobson Micro Needle Holder

Tungsten Carbide Dust Jaws, Round Handle

CODE	TIP	HANDLE	LENGTH
55-2549	Straight, Use with 5-0, 6-0 Suture	With Lock	9 in 229 mm
55-2524	Straight, Use with 5-0, 6-0 Suture	Without Lock	7¼ in 184 mm
55-2526	Straight, Use with 5-0, 6-0 Suture	Without Lock	8½ in 216 mm
55-2535	Straight, Use with 5-0, 6-0 Suture	Without Lock	9¼ in 235 mm
55-2530	Curved, Use with 5-0, 6-0 Suture	Without Lock	8½ in 216 mm

Needle Holders (Micro)



Jacobson Micro Needle Holder

Tungsten Carbide Dust Jaws, Round Handle

CODE	TIP	HANDLE	LENGTH
55-2541	Straight, Use with 7-0 and 8-0 Suture	With Lock	7¼ in 184 mm
55-2540	Curved, Use with 7-0 and 8-0 Suture	With Lock	7¼ in 184 mm

Jacobson Micro Needle Holder

Finely Serrated Stainless Steel Jaws, Flat Handle

CODE	TIP	HANDLE	LENGTH
55-2500	Straight, Use with 4-0, 5-0 and 6-0 Suture	With Lock	7 in 178 mm
55-2510	Straight, Use with 4-0, 5-0 and 6-0 Suture	With Lock	9 in 229 mm

Jacobson Micro Needle Holder

Tungsten Carbide Dust Jaws, Flat Knurled Handle

CODE	TIP	HANDLE	LENGTH
55-2547	Straight, Use with 5-0 and Smaller Suture	With Lock	8 in 203 mm

Jacobson Micro Needle Holder

Tungsten Carbide Dust Jaws, Flat Handle

CODE	TIP	HANDLE	LENGTH
55-2550	Straight, Use with 6-0, 7-0 and 8-0 Suture	With Lock	7 in 178 mm
55-2555	Straight, Use with 6-0, 7-0 and 8-0 Suture	With Lock	7¼ in 184 mm
55-2560	Straight, Use with 6-0, 7-0 and 8-0 Suture	With Lock	8¼ in 210 mm
55-2565	Straight, Use with 6-0, 7-0 and 8-0 Suture	With Lock	9¾ in 238 mm
55-2566	Straight, Use with 6-0, 7-0 and 8-0 Suture	Without Lock	9½ in 241 mm

Needle Holders (Micro)

Jacobson Micro Needle Holder

Straight, Slim Pattern, Jaw Surface with Fine Tungsten Carbide Dust, Use with 7-0 and 8-0 Suture, Slim Line Jacobson

CODE	DESCRIPTION	LENGTH
55-2727	Round Handle with Lock	8¼ in 210 mm
55-2728	Round Handle with Lock	8¼ in 210 mm



55-2727

Jacobson Micro Needle Holder

Straight, Jaw Surfaces with Tungsten Carbide Dust, Use with 5-0, 6-0 Suture

CODE	DESCRIPTION	LENGTH
55-2549	Round Handle with Lock	9 in 229 mm



Micro Needle Holder

Straight, Smooth Jaws

CODE	DESCRIPTION	LENGTH
58-1515	Round Handle with Lock	7 in 178 mm



Needle Holders (Micro)

Micro Needle Holder

Tip Width 0.5 mm

CODE	DESCRIPTION	LENGTH
80-2002	Straight Tip	5½ in 140 mm
80-2003	Curved Tip	5½ in 140 mm



Castroviejo Microsurgical Needle Holder

Tungsten Carbide Inserts with Lock

CODE	DESCRIPTION	LENGTH
36-1006	Smooth Jaws	5½ in 140 mm
36-1007	Smooth Jaws	7 in 178 mm
36-1008	Smooth Jaws	8½ in 216 mm



Needle Holders

Microvascular Classic Plus® Needle Holder

CODE	DESCRIPTION	LENGTH
36-3011	Tungsten Carbide Jaw Inserts, with Lock	9 in 229 mm



Microvascular Needle Holder

Tungsten Carbide Inserts, Use with 5-0 and 6-0 Suture, Ring Handle

CODE	DESCRIPTION	TIP WIDTH	LENGTH
32-431	Serrated Jaw	1.0 mm	6 in 152 mm
32-322	Serrated Jaw	1.0 mm	7 in 178 mm
32-327	Serrated Jaw	1.0 mm	8 in 203 mm
32-352	Serrated Jaw	1.0 mm	9¼ in 235 mm

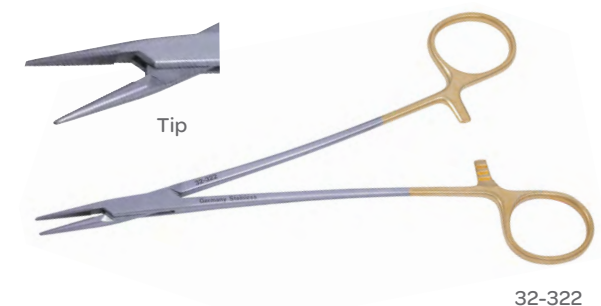

Needle Holders (Micro)



Microvascular Classic Plus® Needle Holder

CODE	DESCRIPTION	LENGTH
36-3010	Tungsten Carbide Jaw Inserts	7 in 178 mm



Ultra™ Micro Needle Holder

Jaw Surface with Fine Tungsten Carbide Dust

CODE	DESCRIPTION	LENGTH
55-2513	Straight, Delicate, Serrated, Use with 7-0 and 8-0 Suture Round Handle, with Lock	7 in 178 mm
55-2515	Straight, Delicate, Serrated, Use with 7-0 and 8-0 Suture Round Handle, with Lock	9 in 229 mm
55-2518	1.0 mm Jaw (25 mm), Use with 5-0, 6-0 and 7-0 Suture Ring Handle	5 in 127 mm
55-2519	1.0 mm Jaw (25 mm), Use with 5-0, 6-0 and 7-0 Suture Ring Handle	5¾ in 146 mm
55-2520	1.0 mm Jaw (25 mm), Use with 5-0, 6-0 and 7-0 Suture Ring Handle	6½ in 165 mm
55-2521	1.0 mm Jaw (25 mm), Use with 5-0, 6-0 and 7-0 Suture, Ring Handle	7¼ in 184 mm
55-2522	1.0 mm Jaw (25 mm), Use with 5-0, 6-0 and 7-0 Suture, Ring Handle	8½ in 216 mm

Needle Holders (Titanium)

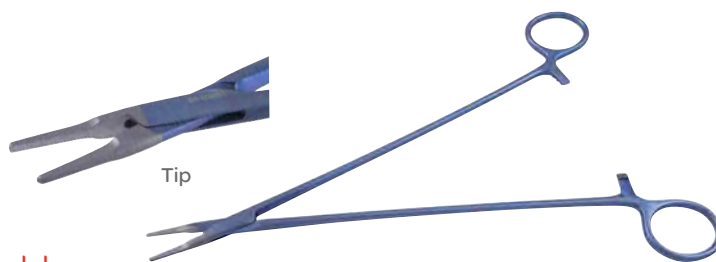

Cardiovascular Titanium Needle Holder

Jaw Surfaces with Fine Tungsten Carbide Dust

CODE	DESCRIPTION	LENGTH
55-0366T	Straight, Ring Handle	10 in 254 mm

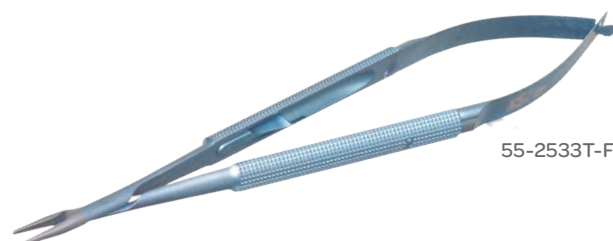

Cardiovascular Titanium Needle Holder

Jaw Surfaces with Tungsten Carbide Dust, Round Handle

CODE	DESCRIPTION	LENGTH
55-2533T-F	Straight, Slim Line Pattern, Use with 7-0 and 8-0 Suture, with Lock	6 in 152 mm
55-2533T	Straight, Use with 5-0, and 6-0 Suture, with Lock	6 ½ in 165 mm
55-2534T	Straight, Use with 5-0, and 6-0 Suture, without Lock	6 ½ in 165 mm
55-2538T	Curved, Use with 5-0, and 6-0 Suture, without Lock	6 ½ in 165 mm

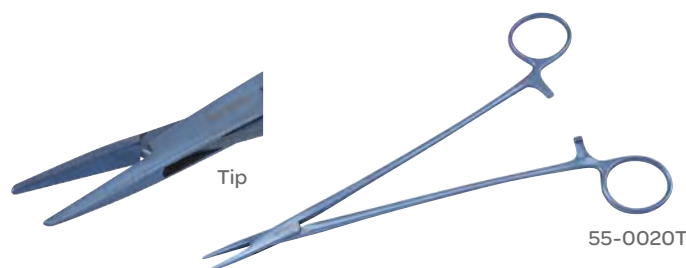

DeBakey Titanium Needle Holder

Straight, Jaw Surfaces with Fine Tungsten Carbide Dust, Ring Handle

CODE	DESCRIPTION	LENGTH
55-0010T	Titanium Needle Holder	7 ¼ in 184 mm
55-0015T	Titanium Needle Holder	8 in 203 mm
55-0020T	Titanium Needle Holder	9 in 229 mm
55-0030T	Titanium Needle Holder	10 in 254 mm

Needle Holders (Titanium)



Tip



80-6006

Needle Holders

Curved, Titanium

CODE	DESCRIPTION	TIP WIDTH	LENGTH	
80-6621	Extra Fine	0.5 mm	6 in	152 mm
80-6006	Fine Tip	0.7 mm	6 in	152 mm
80-6007	Standard Tip	1.0 mm	6 in	152 mm

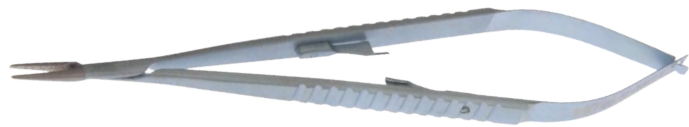

55-2555T-F

Jacobson Micro Titanium Needle Holder, Straight

Jaw Surfaces with Tungsten Carbide Dust

CODE	DESCRIPTION	HANDLE	LENGTH	
55-2526T	Use with 5-0 and 6-0 Suture	Without Lock	8 ¼ in	210 mm
55-2531T	Straight	Round Handle, with Lock	9 in	229 mm
55-2543T	Delicate	Round Handle	10 in	254 mm
55-2523T-F	Use with 5-0 and 6-0 Suture	Round Handle, with Lock	7 in	178 mm
55-2524T	Use with 5-0 and 6-0 Suture	Round Handle, with Lock	7 ¼ in	184 mm
55-2556T	Use with 6-0, 7-0 and 8-0 Suture	Flat Handle, without Lock	7 ¼ in	184 mm
55-2565T	Use with 6-0, 7-0 and 8-0 Suture	Flat Handle, with Lock	9 in	229 mm
55-2555T-F	Slim Line Pattern	Flat Handle, with Lock	7 ¼ in	184 mm
55-2525T-F	Slim Line Pattern, Use with 7-0 and 8-0 Suture	Round Handle, with Lock	8 ¼ in	210 mm
55-2531T-F	Slim Line Pattern, Use with 7-0 and 8-0 Suture	Round Handle, with Lock	9 in	229 mm
55-2543T-F	Slim Line Pattern, Use with 5-0, 6-0 and 7-0 Suture	Round Handle, with Lock	10 in	254 mm



55-2423T-F

Jacobson Micro Titanium Needle Holder, Curved

Jaw Surfaces with Tungsten Carbide Dust

CODE	DESCRIPTION	HANDLE	LENGTH	
55-2423T-F	Use with 5-0 and 6-0 Suture	Round Handle, with Lock	7 in	178 mm
55-2424T	Use with 5-0 and 6-0 Suture	Round Handle, without Lock	7 ¼ in	184 mm
55-2530T	Use with 5-0 and 6-0 Suture	Round Handle, without Lock	8 ¼ in	210 mm
55-2557T	Use with 6-0, 7-0 and 8-0 Suture	Flat Handle, with Lock	7 ¼ in	184 mm
55-2558T	Use with 6-0, 7-0 and 8-0 Suture	Flat Handle, without Lock	7 ¼ in	184 mm
55-2560T	Use with 6-0, 7-0 and 8-0 Suture	Flat Handle, with Lock	8 ½ in	216 mm
55-2560T-F	Slim Line Pattern	Flat Handle, with Lock	8 ½ in	216 mm

Needle Holders



55-2555T

Jacobson Titanium Micro Needle Holder

Flat Handle with Lock, Jaw Surfaces with Tungsten Carbide Dust

CODE	DESCRIPTION	LENGTH
55-2555T	Straight, Use with 6-0, 7-0 and 8-0 Suture	7¼ in 184 mm
55-2557T	Curved, Use with 6-0, 7-0 and 8-0 Suture	7¼ in 184 mm



55-2523T

Jacobson Titanium Needle Holder

Jaw Surfaces with Fine Tungsten Carbide Dust Use with 5-0, and 6-0 Suture, Round Handle with Lock

CODE	DESCRIPTION	LENGTH
55-2523T	Straight	7¼ in 184 mm
55-2525T	Straight	8 in 203 mm
55-2529T	Curved	8 in 203 mm



MagnaFree® MRI Mayo-Hegar Needle Holder

CODE	DESCRIPTION	LENGTH
65-2414	Non-Magnetic (Titanium) for Interventional MRI	7 in 178 mm

Needle Holders (Titanium)

Malis® Needle Holder

Tip Width 0.5 mm, Titanium

CODE	DESCRIPTION	LENGTH
80-1510	Straight Tip	6 ³ / ₄ in 171 mm
80-1511	Curved Tip	6 ³ / ₄ in 171 mm

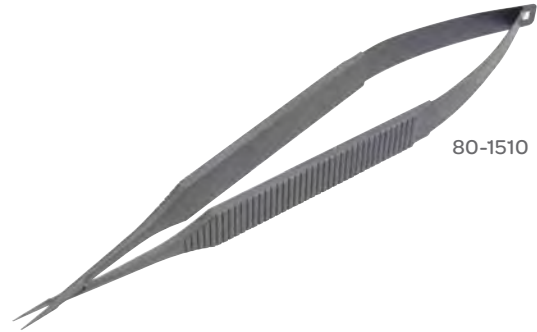

Malis® Needle Holder

Titanium, Straight Tip

CODE	DESCRIPTION	TIP WIDTH	LENGTH
80-1515	Bayonet	0.4 mm	8 ³ / ₄ in 222 mm
80-1512	Bayonet	0.6 mm	8 ³ / ₄ in 222 mm
80-1514	Fine	0.5 mm	6 ³ / ₄ in 171 mm

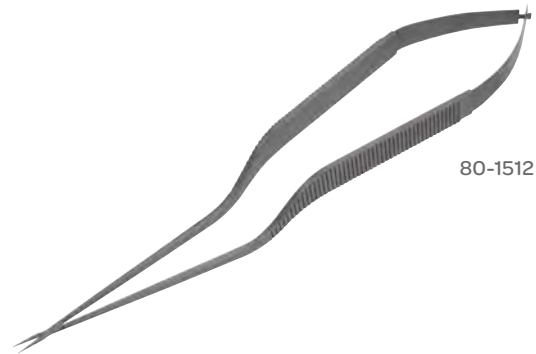

Mayo Hegar Titanium Needle Holder

Jaw Surfaces with Fine Tungsten Carbide Dust, Ring Handle

CODE	DESCRIPTION	LENGTH
55-0120T	Straight	6 ¹ / ₄ in 159 mm
55-0130T	Straight	7 ¹ / ₈ in 181 mm
55-0140T	Straight	8 in 203 mm



Needle Holders (Titanium)

Micro Titanium Needle Holder

Smooth Jaws, Round Handle

CODE	DESCRIPTION	LENGTH	
60-5510	Straight, with Lock	5 in	127 mm
60-5509	Straight, without Lock	5 in	127 mm
60-5520	Straight, without Lock	5 ³ / ₈ in	137 mm
60-5511	Curved, without Lock	5 in	127 mm

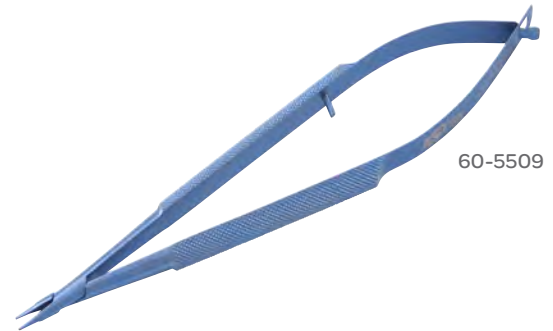

60-5509

Microvascular Titanium Needle Holder

Jaw Surfaces with Fine Tungsten Carbide Dust, Ring Handle

CODE	DESCRIPTION	LENGTH	
55-0322T	Straight	7 ³ / ₈ in	187 mm
55-0352T	Straight	8 ⁵ / ₈ in	219 mm
55-0362T	Straight	10 in	254 mm



55-0322T

Rhoton® Needle Holder

Titanium

CODE	DESCRIPTION	TIP WIDTH	LENGTH	
80-1726	Straight	0.9 mm	7 in	178 mm
80-1725	Curved, Fine	0.5 mm	7 in	178 mm
80-1727	Curved	0.9 mm	7 in	178 mm

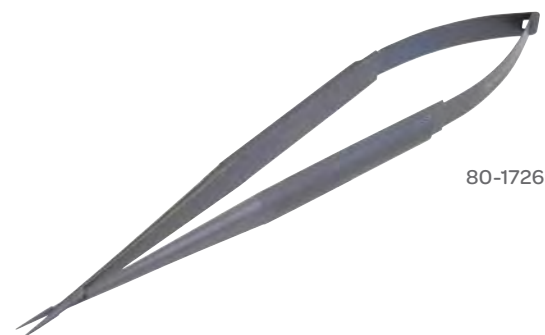

80-1726

Needle Holders (Titanium)

Rhoton® Needle Holders

Bayonet, Titanium

CODE	DESCRIPTION	TIP WIDTH	LENGTH
80-1728	Straight	0.9 mm	8 ½ in 216 mm
80-1746	Straight		9 ½ in 241 mm
80-1729	Curved	0.9 mm	8 ½ in 216 mm
80-1747	Curved		9 ½ in 241 mm



Ryder Titanium Needle Holder

Ring Handle, Jaw Surfaces with Fine Tungsten Carbide Dust

CODE	DESCRIPTION	LENGTH
55-0466T	Straight	6 in 152 mm



Needle Holders (Wire Twister)

Rubio Wire Twister

Snub Nose, Tungsten Carbide Inserts

CODE	DESCRIPTION	LENGTH
32-302	Ring Handle	5 ¼ in 133 mm



Needle Holders (Wire Twister)

Sternal Classic Plus® Needle Holder & Wire Twister

CODE	DESCRIPTION	LENGTH
36-2025	Tungsten Carbide Jaw Inserts	7 in 178 mm



Sternal Wire Twister

Ultra™, Tungsten Carbide Inserts, Use with Sternal Needles and Wire 1-5

CODE	DESCRIPTION	LENGTH
32-132	Ring Handle	8¼ in 210 mm



Ultra™ Sternal Needle Holder

Ultra™, 6.0 mm Jaws, Tungsten Carbide Inserts

CODE	DESCRIPTION	LENGTH
32-303	Ring Handle	7¼ in 184 mm



Ultra™ Sternal Needle Holder & Wire Twister

Ultra™, 6.0 mm Jaws, Tungsten Carbide Inserts

CODE	DESCRIPTION	LENGTH
32-134	Ring Handle	7¼ in 184 mm



Needle Holders

Adson Dural Needle Holder

CODE	DESCRIPTION	LENGTH
64-1000	Fenestrated Jaws	7¼ in 184 mm



Baumgartner Needle Holder

Tungsten Carbide Inserts, Ring Handle

CODE	DESCRIPTION	LENGTH
32-110	Use with 2-0, 3-0, 4-0 Suture	5 in 127 mm



Baumgartner Classic Plus® Needle Holder

CODE	DESCRIPTION	LENGTH
36-2010	Tungsten Carbide Jaw Inserts	5 in 127 mm



Bayonet Needle Holder

CODE	DESCRIPTION	LENGTH
32-157	Tungsten Carbide	7 in 178 mm



Needle Holders

Brown Needle Holders

Convex Jaws, Fine Serrations

CODE	DESCRIPTION	LENGTH
10-0902	Ring Handle	5¼ in 133 mm



Castroviejo Needle Holders

Tungsten Carbide Inserts, Use with 5-0, 6-0 and 7-0 Suture

CODE	DESCRIPTION	LENGTH
32-440	Straight, Flat Spring Handle with Lock	5½ in 140 mm
32-444	Straight, Flat Spring Handle with Lock	7 in 178 mm
32-442	Straight, Flat Handle with Lock	8½ in 216 mm
32-441	Curved, Flat Spring Handle with Lock	5½ in 140 mm



32-440

Castroviejo Needle Holders

Straight, Jaw Surfaces with Fine Tungsten Carbide Dust

CODE	DESCRIPTION	LENGTH
55-2533	Round Handle with Lock	5¾ in 146 mm
55-2534	Round Handle without Lock	5¾ in 146 mm



55-2533

Castroviejo (Jacobson Style) Needle Holders

Tungsten Carbide Inserts, Use with 5-0, 6-0 and 7-0 Suture

CODE	DESCRIPTION	LENGTH
32-446	Curved, Smooth Jaws, Flat Handle with Lock	5½ in 140 mm



Needle Holders

Castroviejo Needle Holders

CODE	DESCRIPTION	LENGTH
36-1000	Tungsten Carbide Inserts with Lock	5½ in 140 mm
36-1002	Tungsten Carbide Inserts with Lock	7 in 178 mm
36-1001	Tungsten Carbide Inserts with Lock	8½ in 216 mm

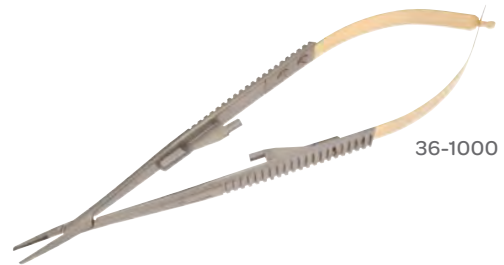

36-1000

Castroviejo-Ryder Needle Holders

1.0 mm Jaws Tungsten Carbide Inserts, Use with 5-0, 6-0 and 7-0 Suture

CODE	DESCRIPTION	LENGTH
32-454	Flat Handle	5½ in 140 mm
32-455	Flat Handle	7¼ in 184 mm
32-456	Flat Handle	8½ in 216 mm

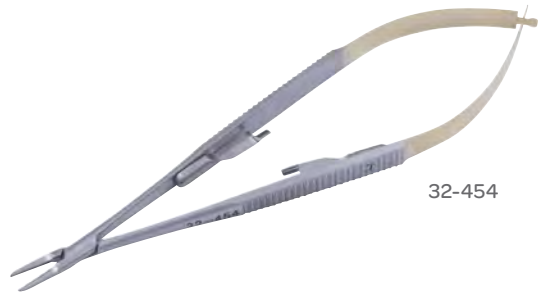

32-454

Cooley Needle Holders

CODE	DESCRIPTION	LENGTH
32-458	Serrated, Jaw Tungsten Carbide Inserts, Delicate, Use with 5.0 and 6.0 Suture	6¾ in 171 mm
32-457	Serrated, Jaw Tungsten Carbide Inserts	6 in 152 mm
32-462	Extra Delicate	8 in 203 mm

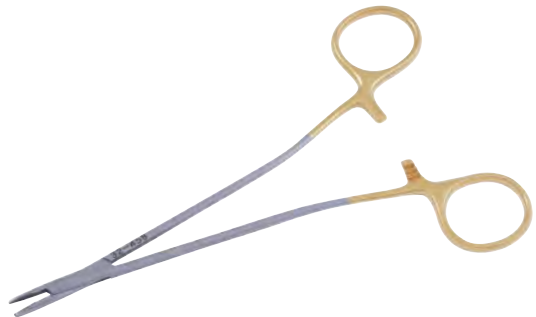

Needle Holders

Crile Wood Needle Holder

Use with 3-0 and 4-0 Suture, Ring Handle, Tungsten Carbide Inserts

CODE	DESCRIPTION	LENGTH
32-435	Straight, Smooth Jaw	6 ¼ in 159 mm
32-430	Straight, Serrated Jaw	5 7/8 in 149 mm
32-320	Straight, Serrated Jaw	7 1/8 in 181 mm
32-325	Straight, Serrated Jaw	8 in 203 mm
32-350	Straight, Serrated Jaw	9 ½ in 241 mm
32-365	Straight, Serrated Jaw	10 1/8 in 257 mm
32-310	Straight, Serrated Jaw	11 ¾ in 298 mm
32-330	Curved, Serrated Jaw	7 7/8 in 181 mm
32-360	Curved, Serrated Jaw	9 in 229 mm
32-350L	Serrated Jaw, Left Handed Pattern	9 in 229 mm



32-310

Crile Wood Needle Holder

Use with 3-0 and 4-0 Suture, Ring Handle

CODE	DESCRIPTION	LENGTH
10-2015	Needle Holder	5 7/8 in 149 mm
10-2018	Needle Holder	7 in 178 mm
10-2020	Needle Holder	8 in 203 mm

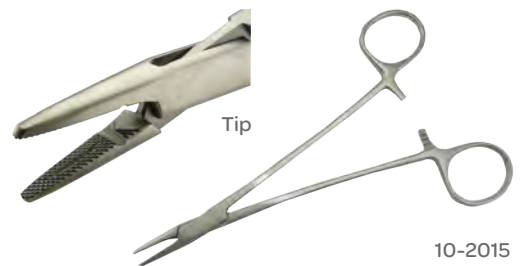

10-2015

Crile-Wood Bariatric Needle Holder

CODE	DESCRIPTION	LENGTH
32-3685	Tungsten Carbide Insert	14 in 356 mm



Crile-Wood Bariatric Needle Holder

CODE	DESCRIPTION	LENGTH
36-2000	Tungsten Carbide Jaw Inserts	6 in 152 mm
64-2509	Tungsten Carbide Jaw Inserts	6 in 152 mm
36-2001	Tungsten Carbide Jaw Inserts	7 in 178 mm
36-2002	Tungsten Carbide Jaw Inserts	8 in 203 mm
36-2003	Tungsten Carbide Jaw Inserts	9 in 229 mm
36-2004	Tungsten Carbide Jaw Inserts	10 in 254 mm
36-2005	Tungsten Carbide Jaw Inserts	12 in 305 mm



36-2000

Needle Holders

DeBakey Needle Holder

2.0 mm Tips, Serrated Jaw, Tungsten Carbide Inserts, Use with 3-0 and 4-0 Suture

CODE	DESCRIPTION	LENGTH
32-010	Ring Handle	7 ¼ in 181 mm
32-030	Ring Handle	10 ¼ in 260 mm
32-040	Ring Handle	12 ¼ in 311 mm



32-010

DeBakey Ultra Light Needle Holder

1.0 mm Tip, Jaws Have Tungsten Carbide Inserts, Use 5-0 and 6-0 Suture

CODE	DESCRIPTION	LENGTH
32-001	Ring Handle	6 ¼ in 159 mm
32-002	Ring Handle	7 in 178 mm
32-003	Ring Handle	8 in 203 mm
32-004	Ring Handle	9 in 229 mm



32-001

Deithrich Needle Holder

1.0 mm Tips, Serrated Jaw, Tungsten Carbide Inserts, Use with 6-0, 7-0 and 8-0 Suture

CODE	DESCRIPTION	LENGTH
32-453	Spring/Ring Handle with Lock	6 ¼ in 159 mm
32-450	Spring/Ring Handle with Lock	7 in 178 mm
32-451	Spring/Ring Handle with Lock	8 in 203 mm



32-450

Needle Holders

Derf Needle Holders

CODE	DESCRIPTION	LENGTH
10-1212	Ring Handle	5 in 127 mm



Derf (Webster) Needle Holder

Tungsten Carbide Inserts, Use with 4-0, 5-0, 6-0 Suture, Ring Handle

CODE	DESCRIPTION	LENGTH
32-400	Standard Pattern	4 3/4 in 121 mm
32-400L	Left-Handed Pattern	4 3/4 in 121 mm



Derf Needle Holders

CODE	DESCRIPTION	LENGTH
36-1010	Tungsten Carbide Jaw Inserts	5 in 127 mm



Diethrich Micro Needle Holders

1.0 mm Jaw (25 mm), Jaw Surface with Fine Tungsten Carbide Dust, Use with 6-0, 7-0 and 8-0 Suture

CODE	DESCRIPTION	LENGTH
55-2570	Flat Handle	5 3/4 in 146 mm



Needle Holders

Euphrate-Pasque Needle Holder

Tungsten Carbide Inserts, Use with 6-0, 7-0 and 8-0 Suture, Ring Handle

CODE	DESCRIPTION	LENGTH
32-153	Micro Insert	7 in 178 mm
32-155	Micro Insert	8 in 203 mm
32-152	Smooth Insert	6 in 152 mm
32-153	Smooth Insert	7 in 178 mm
32-156	Smooth Insert	8 in 203 mm



32-152

French Eye Needle Holder

Tungsten Carbide Inserts, Use with 1-0, 2-0 and 3-0 Suture

CODE	DESCRIPTION	LENGTH
32-200	Ring Handle	6 1/8 in 156 mm
32-210	Ring Handle	7 1/8 in 181 mm



32-200

Halsey Needle Holder

Ring Handle

CODE	DESCRIPTION	LENGTH
10-1013	Smooth Jaws	5 in 127 mm
10-1213	Serrated Jaws	5 in 127 mm

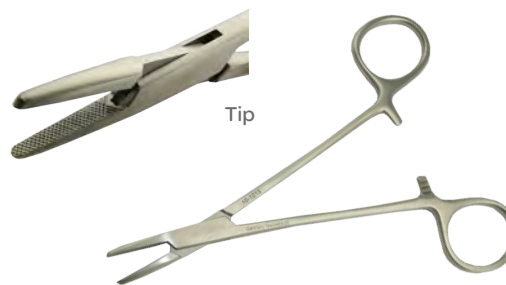

10-1213

Halsey Needle Holder

Ring Handle, Tungsten Carbide Inserts, Use With 5-0, 6-0 Suture

CODE	DESCRIPTION	LENGTH
32-415	Smooth Jaws	5 1/8 in 130 mm
32-410	Serrated Jaws	5 1/8 in 130 mm



32-415

Needle Holders

Halsey Needle Holder

Tungsten Carbide Inserts

CODE	DESCRIPTION	LENGTH
36-1016	Smooth Jaws	5 in 127 mm
36-1015	Serrated Jaws	5 in 127 mm



36-1015

Halsey Needle Holder

Fine Tungsten Carbide Inserts, Use with 1-0, 2-0 and 3-0 Suture, Curved

CODE	DESCRIPTION	LENGTH
32-230	Ring Handle	8 in 203 mm
32-230L	Left Handed	8 in 203 mm
10-3121	Serrated, Ring Handle	8 ¼ in 210 mm
32-235	Ring Handle	10 ½ in 267 mm
32-236		12 in 305 mm
32-239	Ring Handle	14 in 356 mm



32-230

Halsey Needle Holder

CODE	DESCRIPTION	LENGTH
64-6558	Smooth Jaws, Stainless Steel	5 in 127 mm



64-6558

Needle Holders

Heaney Classic Plus® Needle Holders

CODE	DESCRIPTION	LENGTH
36-4010	Curved Tip, Tungsten Carbide Inserts	8¼ in 210 mm



Heaney Needle Holder

CODE	DESCRIPTION	LENGTH
32-3687	Curved, Serrated	14 in 356 mm

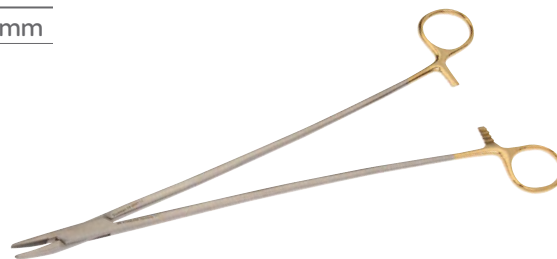

Heaney Needle Holder

CODE	DESCRIPTION	LENGTH
64-2595	Curved, Serrated	8¼ in 210 mm



Intracardiac (Ryder) Needle Holder

2.0 mm Tips, Serrated Jaw, Tungsten Carbide Inserts, Use with 3-0, 4-0 and 5-0 Suture

CODE	DESCRIPTION	LENGTH
32-326	Ring Handle	8 in 203 mm
32-366	Ring Handle	10¼ in 260 mm
32-368	Ring Handle	12 in 305 mm



32-368

Needle Holders

Jacobson Needle Holder

Jaws Have Tungsten Carbide Inserts, Use with 3-0, and 4-0 Suture, Round Handle with Lock

CODE	DESCRIPTION	LENGTH
32-497	Straight	5 $\frac{7}{8}$ in 149 mm
32-489	Straight	7 in 178 mm
32-490	Straight	8 $\frac{1}{4}$ in 210 mm
32-491	Straight	9 in 229 mm
32-495	Curved	9 in 229 mm



32-489

Jacobson Needle Holders

Straight, Smooth Jaws, Titanium

CODE	DESCRIPTION	LENGTH
80-1866	With Lock	7 in 178 mm
80-1867	Without Lock	7 in 178 mm



80-1867

Jacobson Needle Holders

Straight, Smooth Jaws, Titanium

CODE	DESCRIPTION	LENGTH
80-1868	With Lock	8 $\frac{1}{2}$ in 216 mm
80-1869	Without Lock	8 $\frac{1}{2}$ in 216 mm



80-1868

Jones Ima Needle Holder Classic Plus®

CODE	DESCRIPTION	LENGTH
36-3018	Straight	6 in 152 mm
36-3019	Straight	7 in 178 mm



36-3018

Needle Holders

Julian Needle Holder

Jaws Have Tungsten, Carbide Inserts, Use With 5-0 and 6-0 Suture, Ring Handle

CODE	DESCRIPTION	LENGTH
32-475	Straight	8 in 203 mm



Julian Classic Plus® Needle Holders

Tungsten Carbide Inserts

CODE	DESCRIPTION	LENGTH
36-3042	Straight	8 ¼ in 210 mm
36-3043	Curved	8 ¼ in 210 mm



36-3042

Masson Needle Holder

Heavy Pattern, Tungsten Carbide Inserts

CODE	DESCRIPTION	LENGTH
32-304	Needle Holder	16 in 406 mm
32-305	Needle Holder	18 in 458 mm

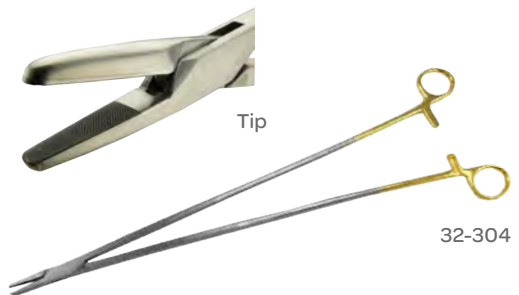

32-304

Mathieu Needle Holder

Serrated Jaw, Tungsten Carbide Inserts Use with 2-0 and 3-0 Suture

CODE	DESCRIPTION	LENGTH
32-190	Flat Spring Handle with Lock	7 ½ in 191 mm



Needle Holders

Mayo-Hegar Needle Holder

Tungsten Carbide Inserts, Use With 1-0, 2-0 Suture

CODE	DESCRIPTION	LENGTH
32-120L	Left Handed Pattern, Ring Handle	6 in 152 mm
32-130L	Left Handed Pattern, Ring Handle	7 in 178 mm
32-140L	Left Handed Pattern, Ring Handle	8 ¼ in 210 mm
32-120	Ring Handle	6 ¼ in 159 mm
32-130	Ring Handle	7 ¼ in 184 mm
32-140	Ring Handle	8 ¼ in 210 mm
32-145	Ring Handle	9 ½ in 241 mm
32-240	Ring Handle	10 ½ in 267 mm
32-300	Ring Handle	11 ⅞ in 302 mm



Mayo-Hegar Needle Holder

CODE	DESCRIPTION	LENGTH
10-1813		5 ¼ in 133 mm
10-1819	Stubby Jaw	7 in 178 mm



Needle Holders

Mayo-Hegar Needle Holder

CODE	DESCRIPTION	LENGTH
36-2015	Tungsten Carbide Jaw Inserts	5 in 127 mm
36-2016	Tungsten Carbide Jaw Inserts	6 in 152 mm
36-2017	Tungsten Carbide Jaw Inserts	7 in 178 mm
36-2018	Tungsten Carbide Jaw Inserts	8 in 203 mm
36-2019	Tungsten Carbide Jaw Inserts	10 in 254 mm
36-2020	Tungsten Carbide Jaw Inserts	12 in 305 mm
32-3686	Tungsten Carbide Insert	14 in 356 mm



36-2015

Mayo-Hegar Needle Holder

CODE	DESCRIPTION	LENGTH
64-2512	Stainless Steel	6 in 152 mm
10-1815	Stainless Steel	6¼ in 159 mm
64-2513	Stainless Steel	7 in 178 mm
10-1818	Stainless Steel	7¾ in 187 mm
10-1820	Stainless Steel	8 in 203 mm
64-2503	Stainless Steel	8 in 203 mm
10-1823	Stainless Steel	9½ in 241 mm
10-1828	Stainless Steel	14 in 356 mm



64-2503

Needle Holder

CODE	DESCRIPTION	LENGTH
78-0220	Curved Smooth Jaws, without Lock	6 in 152 mm
80-2012	Straight, 0.5 mm Tip	7 in 178 mm
78-0138	Curved, 0.4 mm, Round Handle without Lock	7 in 178 mm
80-2013	Curved, 0.5 mm Tip	7 in 178 mm
80-1800	Microvascular Needle Holder Titanium	7 in 178 mm

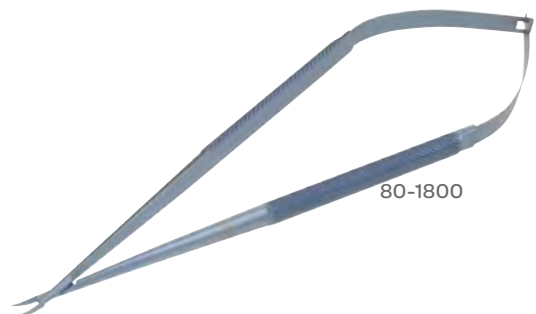

80-1800

Needle Holders

Neivert Needle Holder

CODE	DESCRIPTION	LENGTH
10-0812	Offset Ring Handle, Stainless Steel	4 $\frac{7}{8}$ in 124 mm
32-420	Tungsten Carbide Inserts, Use With 5-0, 6-0 Suture Offset Ring Handle	5 in 127 mm



10-0812

New Orleans Needle Holder

CODE	DESCRIPTION	LENGTH
32-150	Ring Handle	7 in 178 mm
10-1418	Serrated, Ring Handle	7 in 178 mm

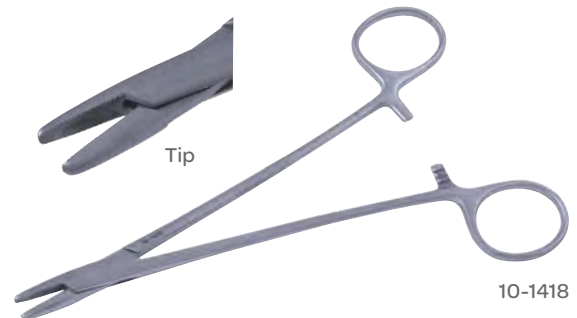

10-1418

Olsen-Hegar Needle Holder

Combination Needle Holder And Scissors, Use with 3-0 and 4-0 Suture

CODE	DESCRIPTION	LENGTH
32-159	Tungsten Carbide Inserts	5 in 127 mm
32-160	Tungsten Carbide Inserts	5 $\frac{1}{2}$ in 140 mm
32-170	Tungsten Carbide Inserts	5 $\frac{3}{4}$ in 146 mm
32-180	Tungsten Carbide Inserts Ring Handle	7 $\frac{1}{2}$ in 191 mm



32-180

Needle Holders

Olsen Hegar Needle Holder

Combination of Needle Holder and Scissors

CODE	DESCRIPTION	LENGTH
36-4000	Tungsten Carbide Jaw Inserts	5½ in 140 mm



Par Needle Holder

Tungsten Carbide Inserts, Use with 6-0, 7-0 Suture

CODE	DESCRIPTION	LENGTH
32-404	Ring Handle	4¾ in 118 mm



Rogers Classic Plus® Needle Holder

Tungsten Carbide Inserts

CODE	DESCRIPTION	LENGTH
36-4011	Curved Jaws	10½ in 267 mm



Rubio Classic Plus® Needle Holder

Tungsten Carbide Jaw Inserts, Tip 1.14 mm, Serrated Jaw

CODE	DESCRIPTION	LENGTH
36-2024	Offset Handles	7⅝ in 194 mm



Needle Holders

Ryder Needle Holder

Tungsten Carbide Inserts, Use with 5-0, 6-0 and 7-0 Suture

CODE	DESCRIPTION	TIP	LENGTH
32-465	Serrated Jaw, Ring Handle	1.0 mm	5¼ in 133 mm
32-466	Serrated Jaw, Ring Handle	1.0 mm	6 in 152 mm
32-467	Serrated Jaw, Ring Handle	1.0 mm	7¼ in 184 mm
32-468	Serrated Jaw, Ring Handle	1.0 mm	8 in 203 mm
32-469	Serrated Jaw, Ring Handle	1.0 mm	9 in 229 mm
32-472	Serrated Jaw, Ring Handle	1.0 mm	10¼ in 260 mm
32-467L	Serrated Jaw, Left-Handed	1.0 mm	7 in 178 mm
32-467XL	Serrated Jaw, Extra Large	1.0 mm	12 in 305 mm
32-468S	Smooth Jaw, Ring Handle	1.0 mm	8 in 203 mm



32-465

Ryder Needle Holder

Jaw Surface with Fine Tungsten Carbide Dust, Use with 6-0, 7-0 and 8-0 Suture

CODE	DESCRIPTION	LENGTH
55-2660	Ring Handle	6½ in 165 mm
55-2662	Ring Handle	7¼ in 184 mm
55-2664	Ring Handle	8½ in 216 mm



55-2660

Needle Holders

Ryder Classic Plus® Needle Holder

Serrated Jaw, Tungsten Carbide Jaw Inserts

CODE	JAW WIDTH	TIP SIZE	LENGTH
36-3023	1.0 mm	1.5 mm	5 in 127 mm
36-3014	1.0 mm	1.5 mm	6 in 152 mm
36-3012	1.0 mm	1.5 mm	7 in 178 mm
36-3015	1.0 mm	1.5 mm	8 in 203 mm
36-3013	1.0 mm	1.5 mm	9 in 229 mm
36-3000	2.0 mm	1.5 mm	5 in 127 mm
36-3001	2.0 mm	1.5 mm	6 in 152 mm
36-3002	2.0 mm	1.5 mm	7 in 178 mm
36-3003	2.0 mm	1.5 mm	8 in 203 mm
36-3004	2.0 mm	1.5 mm	9 in 229 mm
36-3005	2.0 mm	1.5 mm	10 in 254 mm



36-3000

Ryder Classic Plus® Needle Holder

Smooth Jaw, Tungsten Carbide Jaw Inserts

CODE	JAW WIDTH	LENGTH
36-3022	1.0 mm	5 in 127 mm
36-3007	1.0 mm	6 in 152 mm
36-3008	1.0 mm	7 in 178 mm
36-3009	1.0 mm	9 in 229 mm



36-3007

Needle Holders

Sarot Needle Holder

Tungsten Carbide Inserts, Ring Handle, Use with 3-0 and 4-0 Suture

CODE	DESCRIPTION	LENGTH
32-340	Serrated Jaw	7 ³ / ₈ in 187 mm
32-342	Serrated Jaw	8 in 203 mm
32-344	Serrated Jaw	9 in 229 mm
10-2218	Serrated Jaw, Stainless Steel	7 ¹ / ₄ in 184 mm



Sarot Classic Plus® Needle Holder

CODE	DESCRIPTION	LENGTH
36-3020	Tungsten Carbide Jaw Inserts	7 in 178 mm
36-3021	Tungsten Carbide Jaw Inserts	10 in 254 mm



Spencer Needle Holder

Tungsten Carbide Inserts, Flat Handle

CODE	JAW WIDTH	LENGTH
32-185	0.76 mm	7 ¹ / ₄ in 184 mm



Needle Holders

Stratte Needle Holder

Curved Jaws, Tungsten Carbide Inserts

CODE	DESCRIPTION	LENGTH
32-255	Bent Shanks, Ring Handle	8 ¼ in 210 mm
32-256	Bent Shanks	9 in 229 mm
32-251	Bent Shanks, Curved to the Right	9 in 229 mm



Stratte Classic Plus® Needle Holder

Tungsten Carbide Inserts

CODE	DESCRIPTION	LENGTH
36-4015	Curved Jaw	9 in 229 mm

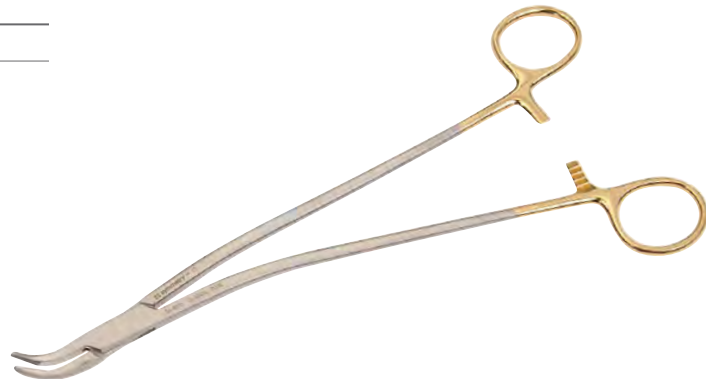

Sweden Needle Holder

Tungsten Carbide Inserts, Delicate, Ring Handle, Use with 5-0 and 6-0 Suture

CODE	JAWS	LENGTH
32-460	1.5 x 8.0 mm	6 ¾ in 171 mm

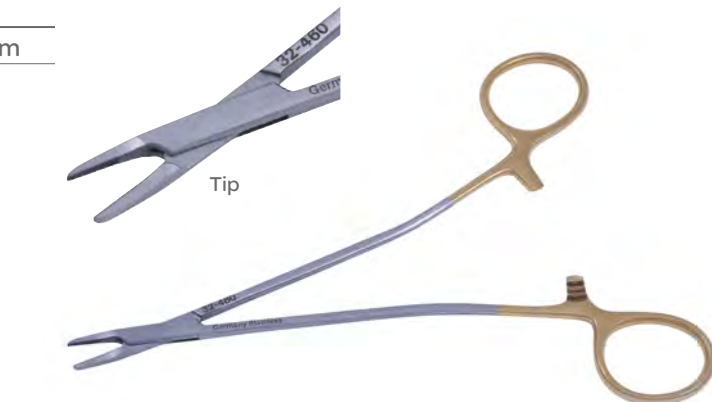

Needle Holders

Total Occlusion Needle Holder

Tungsten Carbide Inserts

CODE	DESCRIPTION	LENGTH
37-4029	Smooth Jaw	4 ¾ in 121 mm



Wangensteen Classic Plus® Needle Holder

CODE	DESCRIPTION	LENGTH
36-4020	Tungsten Carbide Jaw Inserts	10 ½ in 267 mm

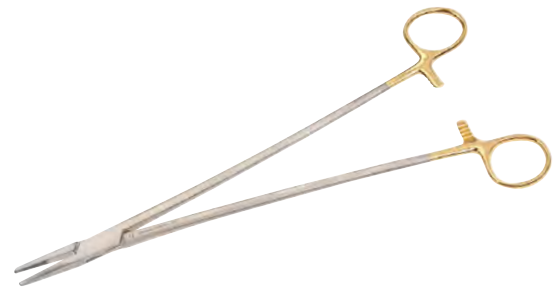

Webster Needle Holder

Ring Handle, Use with 4-0, 5-0, 6-0 Suture

CODE	DESCRIPTION	LENGTH
32-405	Fine Tungsten Carbide Inserts,	4 ½ in 114 mm
32-405L	Fine Tungsten Carbide Inserts, Left Handed	4 ½ in 114 mm



Webster Needle Holder

Ring Handle

CODE	DESCRIPTION	LENGTH
10-1012	Smooth Jaws, Non-Tungsten	5 in 127 mm



Needles

Heparin Needle

CODE	DESCRIPTION	LENGTH
54-6016	Medium Tip, 3.7 mm	2 $\frac{1}{8}$ in 55 mm



Webster Infusion Needle

CODE	DESCRIPTION	LENGTH
09-5011	Straight	2 $\frac{7}{16}$ in 62 mm
09-5012	Curved	2 $\frac{3}{8}$ in 60 mm



09-5012

Heparin Needle

CODE	DESCRIPTION	LENGTH
54-6000	Olive Tip, 2.9 mm	2 in 51 mm



Reverdin Needle

CODE	DESCRIPTION	LENGTH
13-6101	#1	7 $\frac{1}{2}$ in 191 mm
13-6102	#2	7 $\frac{1}{2}$ in 191 mm
13-6103	#3	7 $\frac{1}{2}$ in 191 mm
13-6104	#4	7 $\frac{1}{2}$ in 191 mm
13-6201	#1	8 $\frac{1}{4}$ in 210 mm
13-6202	#2	8 $\frac{1}{4}$ in 210 mm
13-6203	#3	8 $\frac{1}{4}$ in 210 mm
13-6204	#4	8 $\frac{1}{4}$ in 210 mm



13-6101

Pin Wheels

Wartenberg Pin Wheel

CODE	LENGTH
44-3025	7¼ in 184 mm



Pliers

Heavy Duty Lock Pliers

CODE	DESCRIPTION	LENGTH
37-4101	Vice Grips	7 in 178 mm
32-3337	Tip Width 0.9 cm	8 in 203 mm



Needle Nose Pliers

CODE	DESCRIPTION	LENGTH
32-3339	Wire Notch	5½ in 140 mm



Pliers

Needle Nose Pliers

CODE	DESCRIPTION	LENGTH
37-4100	Serrated Jaws	6¼ in 159 mm



Pliers

CODE	DESCRIPTION	LENGTH
14-4600	Flat Nose Pliers, 2.0 mm Tip	6 in 152 mm

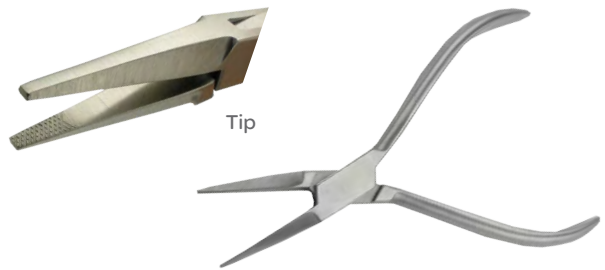

Pliers

CODE	DESCRIPTION	LENGTH
14-5000	Slip Joint Pliers	6 in 152 mm



Pliers

CODE	DESCRIPTION	LENGTH
14-5620	Parallel Pliers	7 in 175 mm



Probes

Excavator & Probe

CODE	DESCRIPTION	LENGTH
43-8501	Double-Ended	6 in 152 mm



Double-Ended Probe

2.0 mm Diameter on Tip

CODE	DESCRIPTION	LENGTH
09-0514	Stainless Steel	5 3/4 in 146 mm
09-0515	Stainless Steel	6 in 152 mm
09-0520	Stainless Steel	8 in 203 mm

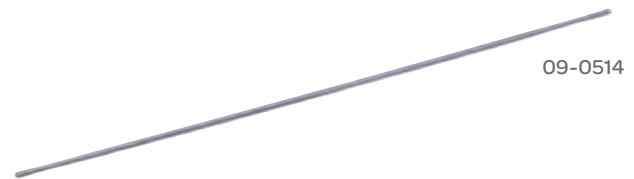

09-0514

Grooved Director & Tounge Tie Probe

2.0 mm Diameter on Tip

CODE	DESCRIPTION	LENGTH
09-1512	Stainless Steel	4 1/2 in 114 mm
09-1513	Stainless Steel	5 1/8 in 130 mm
09-1514	Stainless Steel	5 3/4 in 146 mm
09-1516	Stainless Steel	6 1/4 in 159 mm
09-1613	Stainless Steel, Probe End	5 1/8 in 130 mm
09-1614	Stainless Steel, Probe End	5 3/4 in 146 mm



09-1512

Probes

Probe with Eye

CODE	DESCRIPTION	LENGTH
49-4030	Stainless Steel	4 ½ in 114 mm
49-4031	Stainless Steel	5 in 127 mm
49-4032	Stainless Steel	5 ½ in 140 mm
49-4033	Stainless Steel	6 in 152 mm
49-4035	Stainless Steel	8 in 203 mm
49-4037	Stainless Steel	10 in 254 mm



49-4030

Bowman Lacrimal Probe

Double-Ended, Malleable, Silver

CODE	DESCRIPTION	LENGTH
49-6500	0000-000	4 7/8 in 118 mm
49-6501	00-0	4 7/8 in 118 mm
49-6502	1-2	4 7/8 in 118 mm
49-6503	3-4	4 7/8 in 118 mm
49-6504	5-6	4 7/8 in 118 mm
49-6505	7-8	4 7/8 in 118 mm



49-6503

Probe

CODE	DESCRIPTION	LENGTH
09-1113	Stainless Steel	5 1/8 in 130 mm
09-1114	Stainless Steel	5 1/2 in 140 mm
09-1115	Stainless Steel	6 in 152 mm
09-1120	Stainless Steel	8 in 203 mm



09-1113

Punches (Dermal Punch)

Keyes Dermal Punch

CODE	DESCRIPTION	LENGTH
43-0302	2.0 mm	3 3/4 in 95 mm
43-0303	3.0 mm	3 3/4 in 95 mm
43-0304	4.0 mm	3 3/4 in 95 mm
43-0305	5.0 mm	3 3/4 in 95 mm
43-0306	6.0 mm	3 3/4 in 95 mm
43-0307	7.0 mm	3 3/4 in 95 mm
43-0308	8.0 mm	3 3/4 in 95 mm

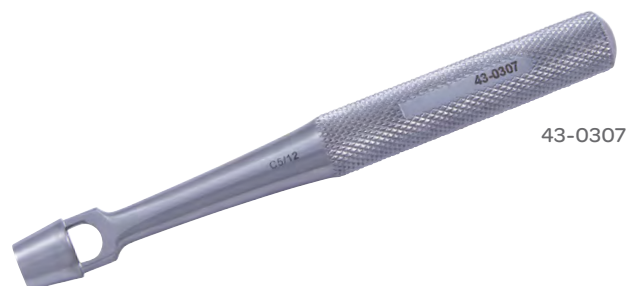

43-0307

Raspatories

Joseph Periosteal Raspatory

CODE	DESCRIPTION	TIP WIDTH	WORKING DISTANCE	LENGTH
52-1005	Sharp	¼ in 6.0 mm	1 ⅝ in 41 mm	6 ⅞ in 175 mm



Retractors (Abdominal)

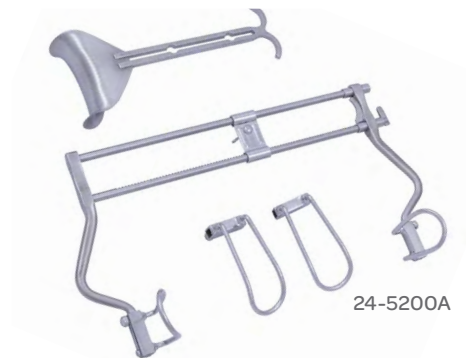

Balfour Abdominal Retractor

Includes Two Pairs of Lateral "Snap On" Wire Blades 2 ½ in and 3 ½ in Deep, 24-5012B Center Blade

CODE	DESCRIPTION	MAXIMUM SPREAD	SIDE BLADE DEPTH
24-5200A	Complete, Snap on Lateral Blades	10 ½ in 267 mm	2 ½ in 64 mm
24-5200AA	Complete, Snap on Lateral Blades	14 in 356 mm	2 ½ in 64 mm
24-5200AAA	Complete, Snap on Lateral Blades	16 in 405 mm	3 ½ in 90 mm
24-7015	Complete, Fixed Blades 4 in deep, with Center Blade	7 ⅞ in 181 mm	4 in 102 mm
24-7017	Complete, Fixed Blades 4 in deep, with Center Blade	10 in 254 mm	4 in 102 mm



Balfour Retractor Snap-On Lateral Blades

CODE	DESCRIPTION	DEPTH
24-5201	Wire	2 ½ in 63 mm
24-5204	Solid	4 in 102 mm

Retractors (Abdominal)



Balfour Fenestrated Retractor

With 2 Lateral Blades and 1 Center Blade

CODE	TOTAL OPENING		LATERAL BLADE (W X D)		CENTER BLADE (W X D)	
50-4500	7 in	178 mm	1¼x2 in	32x51 mm	3x2 in	76x51 mm



Balfour Retractor Complete

Self-Retaining with Ratchet Crossbar

CODE	COMPLETE TOTAL OPENING		LATERAL BLADES (W X D)		CENTER BLADE (W X D)	
50-4514	7 in	178 mm	1½x2¼ in (38 x 57 mm)	1½x3¼ in (38 x 83 mm)	¾x2¼ in (83 x 57 mm)	2½x2½ in (64 x 64 mm)

Retractors (Abdominal)

Balfour Retractor Blade

CODE	DESCRIPTION	LENGTH (W X D)	CODE	DESCRIPTION	LENGTH (W X D)
24-5012B	Standard Blade	2½ x 1¾ in (64 x 44 mm)	24-5022B	Supra-Pubic Blade	2¾ x 2⅝ in (70 x 67 mm)
24-5014B	Standard Blade	3⅝ x 1¾ in (92 x 44 mm)	24-5024B	Supra-Pubic Blade	3⅜ x 2¾ in (86 x 70 mm)



Balfour Retractor Blade

CODE	DESCRIPTION
24-5060C	Center Blade Attachment, with Wing Nut



Balfour Retractor Blade

CODE	DESCRIPTION	LENGTH (W X D)
24-7071	Center Blade	2½ x 1½ in 64 x 38 mm
24-7072	Center Blade	3 x 2 in 76 x 51 mm
24-7073	Center Blade	3⅝ x 2½ in 86 x 64 mm
24-7074	Center Blade	3⅞ x 2⅞ in 79 x 73 mm
24-5032B	Center Blade	2½ x 3½ in 64 x 89 mm
24-7075	Center Blade	2¾ x 4 in 70 x 102 mm



Retractors (Abdominal)

Balfour Retractor Blade

CODE	DESCRIPTION	LENGTH (W X D)
24-7085	Horgan Center Blade, Malleable	2x5 in 51x127 mm



Balfour Retractor Blade

CODE	DESCRIPTION	LENGTH (W X D)
24-5036B	Horgan Blade, Malleable	2½ x 6½ in 64 x 165 mm



Horgan Retractor Blade

CODE	DESCRIPTION	BLADE LENGTH	LENGTH
50-4524	Center Blade	7¾ in 197 mm	14¾ in 375 mm



Balfour Retractor Blade

CODE	DESCRIPTION	LENGTH (W X D)
24-5028B	Narrow Blade	1⅝ x 3½ in 41 x 89 mm



Retractors (Abdominal)

Balfour Fenestrated Retractor

One Pair, Use with 50-4503 and 50-4509

CODE	DESCRIPTION	DEPTH
50-4505	Lateral Blade	3 ½ in 89 mm
50-4506	Lateral Blade	4 in 102 mm



50-4505

Balfour Retractor Fourth Arm Attachment

Without Blade

CODE	DESCRIPTION	LENGTH
24-5062L	Left	12 in 305 mm
50-4526	Left	12 in 305 mm
50-4527	Right	12 in 305 mm



50-4526

Balfour Retractor Blade

CODE	DESCRIPTION
24-5062C	Clamp for Balfour Fourth Blade Attachment, with Wing Nut

Retractors (Abdominal)



Baby Balfour Retractor

Abdominal Retractor, Miniature Model, Self-Retaining With Fixed Lateral Fenestrated Blades And One Center Blade

CODE	TOTAL OPENING		ARM LENGTH		LATERAL BLADE		CENTER BLADE	
50-5651	3 ³ / ₄ in	95 mm	3 ³ / ₄ in	95 mm	1 x 1 in	25 x 25 mm	1 x 1 in	25 x 25 mm

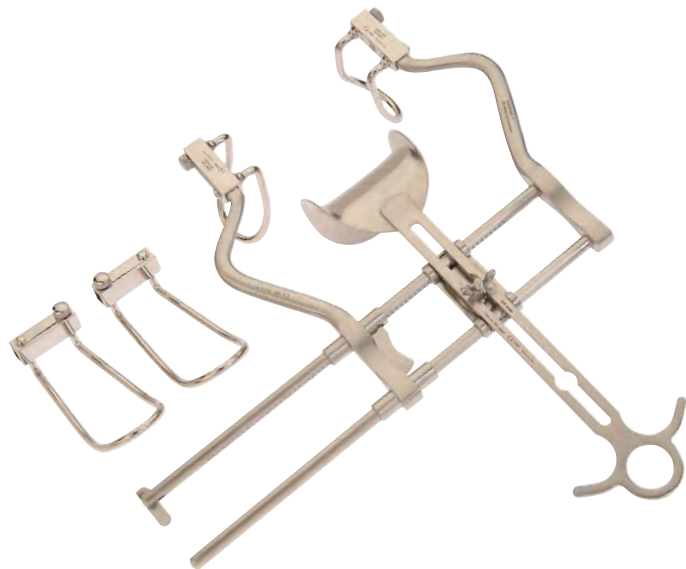

Balfour Retractor with Fenestrated Blades

Abdominal Retractor, Self-Retaining with Trigger Ratchet. Includes Two Pair Of Detachable Lateral Fenestrated Blades And One Center Blade

CODE	TOTAL OPENING		LATERAL BLADES (W X D)		CENTER BLADE (W X D)		TOTAL WIDTH
50-4503	7 ⁵ / ₈ in	194 mm	1 ³ / ₄ x 2 ¹ / ₂ in	44 x 64 mm	2 ¹ / ₂ x 2 ¹ / ₂ in	64 x 64 mm	7 ⁵ / ₈ 194 mm
			1 ³ / ₄ x 3 ³ / ₈ in	44 x 86 mm			

Retractors (Abdominal)



Balfour Retractor with Fenestrated Blades

Abdominal Retractor, Self-Retaining. With Two Fixed Blades, Two Removable Small Blades And One Large Removable Blade

CODE	TOTAL OPENING	LATERAL BLADE (W X D)	CENTER BLADE (W X D)
50-4510	8½ in 216 mm	1½ x 2½ in 38 x 64 mm	2½ x 2½ in 64 x 64 mm



B.E. Glass Abdominal Retractor

CODE	DIMENSIONS (W X D)	LENGTH
24-3380	6 x 3¼ in 153 x 83 mm	9¾ in 248 mm



O'Connor-O'Sullivan Abdominal Retractor

Abdominal Retractor, self-retaining. Includes two fixed blades, two removable small blades and one large removable blade.

CODE	DESCRIPTION	SMALL BLADE (W X D)	FIXED BLADE (W X D)	LARGE BLADE
50-4400	Self-Retaining	1¾ x 3¼ in (44 x 83 mm)	1 x 2 in (25 x 51 mm) Opening: 5½ in (140 mm)	4 in (102 mm) Opening: 6½ in (159 mm)

Retractors (Abdominal)

O'Connor-O'Sullivan Abdominal Retractor

CODE	DESCRIPTION	LENGTH	
24-8500	Complete Set (24-8509, 24-8511, 24-8512)		
24-8509	Frame Only, with 2 Rotatable Lateral Blades Attached	1 x 2½ in	25 x 60 mm
24-8511	Center Blade, 2/Each Included in 24-8500	1¾ x 3¼ in	44 x 83 mm
24-8512	Center Blade, 1/Each Included in 24-8500	2¾ x 4⅛ in	70 x 105 mm
24-8599	Wing Nuts (Pair)		

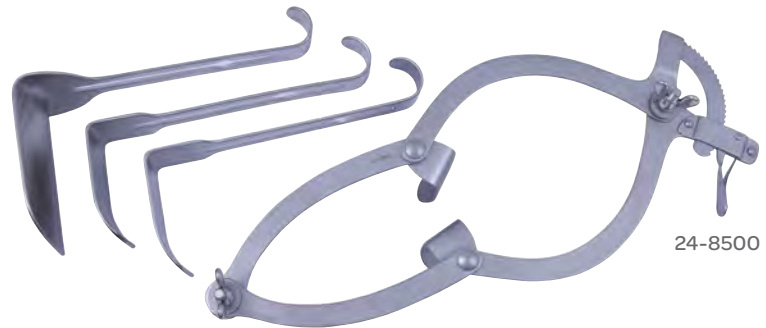

Retractors (Bookwalter® Horizontal Bars)

Bookwalter® Gooseneck Horizontal Bar

CODE	DESCRIPTION	LENGTH
50-4681	Gooseneck Table Post for 1 in (25 mm) System, Includes Built In Coupler. For Use with 50-4680	



Retractors (Bookwalter® Horizontal Bars)

Bookwalter® Lightweight Horizontal Bar

CODE	DESCRIPTION	LENGTH
50-4552	Horizontal Bar	14 ¼ in 362 mm

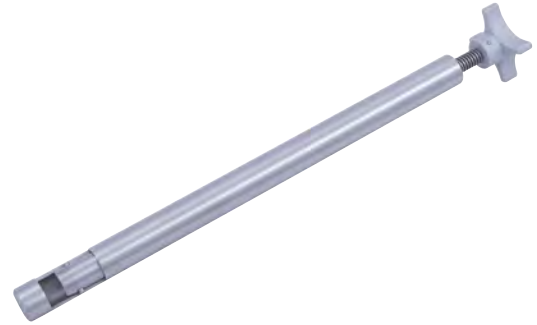

Bookwalter® Lightweight Horizontal Flexbar

CODE	DESCRIPTION
50-4582	Horizontal Flexbar with 360° Rotation

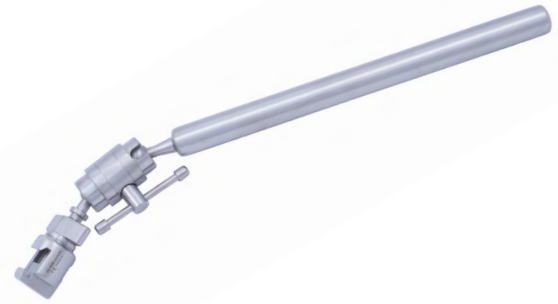

Bookwalter® Ironman Horizontal Ring Holder

CODE	DESCRIPTION
50-4678	Horizontal Bar with incorporated Coupler for added adjustability

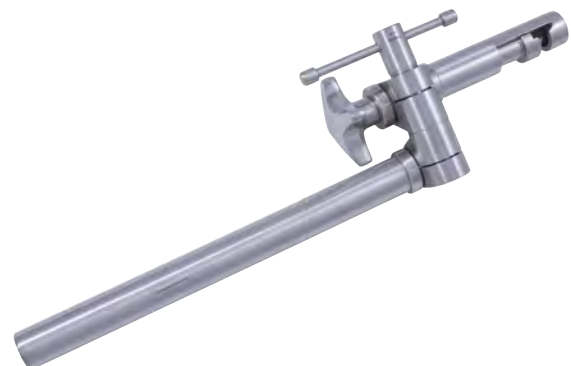

Retractors (Bookwalter® Horizontal Bars)

Bookwalter® Lightweight Horizontal Bar

CODE	DESCRIPTION
50-4618	Bookwalter® Lightweight Horizontal Bar 50-4618 Horizontal Bar, Lightweight design that can be back fed into the Bookwalter® Coupler.

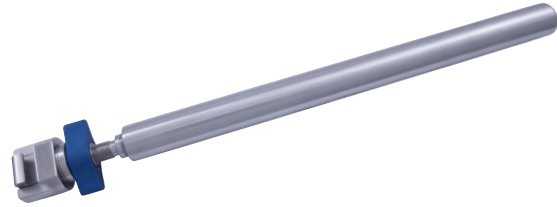

Bookwalter® Lightweight Extension Bar

CODE	LENGTH
50-4553	12 in 305 mm
50-4797	18 in 458 mm



50-4553

Retractors (Bookwalter® Blades)

Bookwalter® Balfour Blade

CODE	WIDTH	DEPTH
50-4576	2 ⁵ / ₈ in 67 mm	3 in 76 mm
BW1271017	3 ¹ / ₂ in 89 mm	2 ³ / ₄ in 70 mm

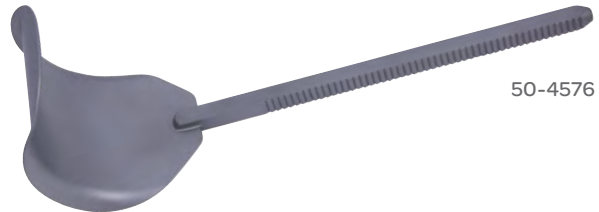

50-4576

Bookwalter® Gelpi Blade

CODE	DESCRIPTION
50-4577	Sharp Tip



Retractors (Bookwalter® Blades)

Bookwalter® Harrington Blade

CODE	DESCRIPTION	WIDTH		DEPTH	
50-4566	Harrington Blade	2½ in	63 mm	5⅝ in	143 mm
BW1045176	Harrington Blade	3½ in	88 mm	10 in	253 mm



50-4566

Bookwalter® Kelly Blade

CODE	DESCRIPTION	WIDTH		DEPTH	
50-4574	Kelly Blade	1 in	25 mm	1 in	25 mm
50-4575	Kelly Blade	1 in	25 mm	2½ in	64 mm
50-4565	Kelly Blade	2 in	51 mm	1½ in	38 mm
50-4563	Kelly Blade	2 in	51 mm	2 in	51 mm
50-4572	Kelly Blade	2 in	51 mm	2½ in	64 mm
50-4568	Kelly Blade	2 in	51 mm	3 in	76 mm
50-4569	Kelly Blade	2 in	51 mm	4 in	102 mm
50-4570	Kelly Blade	2 in	51 mm	5 in	127 mm
50-4571	Kelly Blade	2 in	51 mm	6 in	152 mm
BW1045000	Kelly Blade	2 in	51 mm	8 in	203 mm



50-4568

Bookwalter® Rake Retractor

Sharp Teeth

CODE	DESCRIPTION	WIDTH		DEPTH	
50-4644	3 Prongs	⅔ in	17 mm	¾ in	19 mm
50-4645	4 Prongs	¾ in	19 mm	⅓ in	8.4 mm
50-4646	5 Prongs	1 in	25 mm	⅓ in	8.4 mm

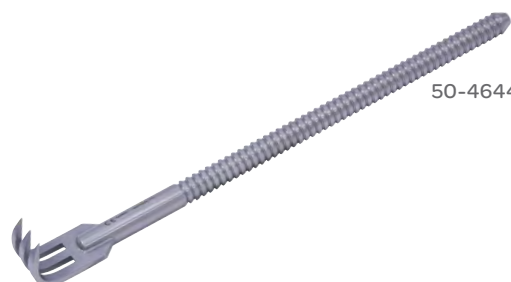

50-4644

Retractors (Bookwalter® Blades)

Bookwalter® Richardson Blade

CODE	WIDTH X LENGTH
50-4597	$\frac{3}{4}$ x 1 in 19 x 25 mm
50-4598	$\frac{3}{4}$ x 2 in 19 x 51 mm
50-4599	1 x $1\frac{1}{4}$ 25 x 32 mm



Bookwalter® Scoville Hook

CODE	DESCRIPTION	DEPTH
50-4640	Small	2 in 51 mm
50-4639	Large	$3\frac{1}{4}$ in 83 mm

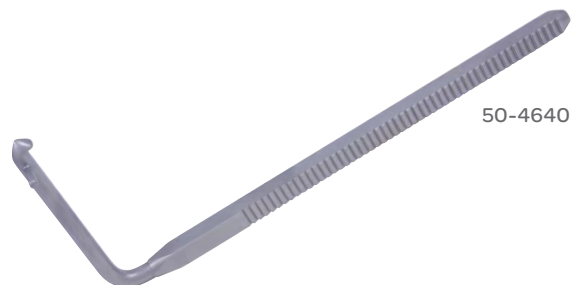

Bookwalter® -Meyerding Retractor Blade

Small Sharp Teeth

CODE	DESCRIPTION	DIMENSIONS
50-4641	Small	$\frac{2}{3}$ x $2\frac{1}{3}$ in 17 x 60 mm
50-4642	Medium	1 x $3\frac{1}{3}$ in 25 x 85 mm
50-4643	Large	2 x $3\frac{3}{4}$ in 51 x 95 mm



Bookwalter® Opti-Length® Retractor Blade

Ebonized

CODE	DESCRIPTION	WIDTH X LENGTH
67-7502	Malleable with Lip	$1\frac{1}{2}$ x 11 in 38 x 279 mm
67-7504	Malleable with Lip	2 x 11 in 51 x 279 mm
67-7499	Malleable with Lip	3 x 11 in 76 x 279 mm
67-7500	Malleable with Lip	4 x 11 in 102 x 279 mm



Retractors (Bookwalter® Blades)

Bookwalter® Malleable Retractor Blade

Stainless Steel Matte Finish

CODE	WIDTH X LENGTH	
50-4561	2 x 6 in	51 x 152 mm
50-4562	1½ x 6 in	38 x 152 mm
50-4567	3 x 6 in	76 x 152 mm
BW1043016	2 x 10 in	51 x 254 mm
BW1043029	3 x 10 in	76 x 254 mm
BW1045069	4 x 8 in	101 x 203 mm

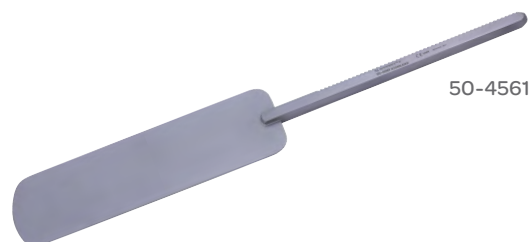

50-4561

Bookwalter® Malleable Blade With Lip

CODE	DESCRIPTION	WIDTH X LENGTH	
50-4694	Small	1 x 4 in	25 x 102 mm
50-4672	Medium	1½ x 6 in	38 x 152 mm
50-4673	Large	2 x 6 in	51 x 152 mm
50-4674	X-Large	3 x 6 in	76 x 152 mm

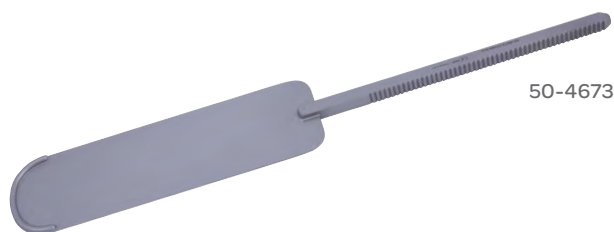

50-4673

Bookwalter® Retractor Blade

CODE	DESCRIPTION	WIDTH X LENGTH	
50-4669	Small	1½ x 6 in	38 x 152 mm
50-4670	Medium	2 x 6 in	51 x 152 mm
50-4671	Large	2 x 6 in	76 x 152 mm



50-4669

Bookwalter®-Magrina Retractor Blade

CODE	DESCRIPTION	WIDTH X LENGTH	
50-4691	Malleable with Lip	1 x 4 in	25 x 102 mm



Retractors (Bookwalter® Blade)

Bookwalter® Radiolucent Titanium Blade

Low Glare Gold Coating

CODE	DESCRIPTION	WIDTH X LENGTH	
505580	Titanium Blade	1 x 4 in	25 x 102 mm
505581	Titanium Blade	1 x 5 in	25 x 127 mm
505582	Titanium Blade	1 x 6 in	25 x 152 mm
505583	Titanium Blade	1 x 7 in	25 x 178 mm
505584	Titanium Blade	1 x 8 in	25 x 203 mm
505585	Titanium Blade	2 x 4 in	51 x 102 mm
505586	Titanium Blade	2 x 5 in	51 x 127 mm
505587	Titanium Blade	2 x 6 in	51 x 152 mm
505588	Titanium Blade	2 x 7 in	51 x 178 mm
505589	Titanium Blade	2 x 8 in	51 x 203 mm



505581

Bookwalter® Lightweight Post Coupling

CODE	DESCRIPTION	LENGTH	
50-4554	Malleable with Lip	1 x 1 in	25 x 25 mm



Retractors (Bookwalter® Kits)

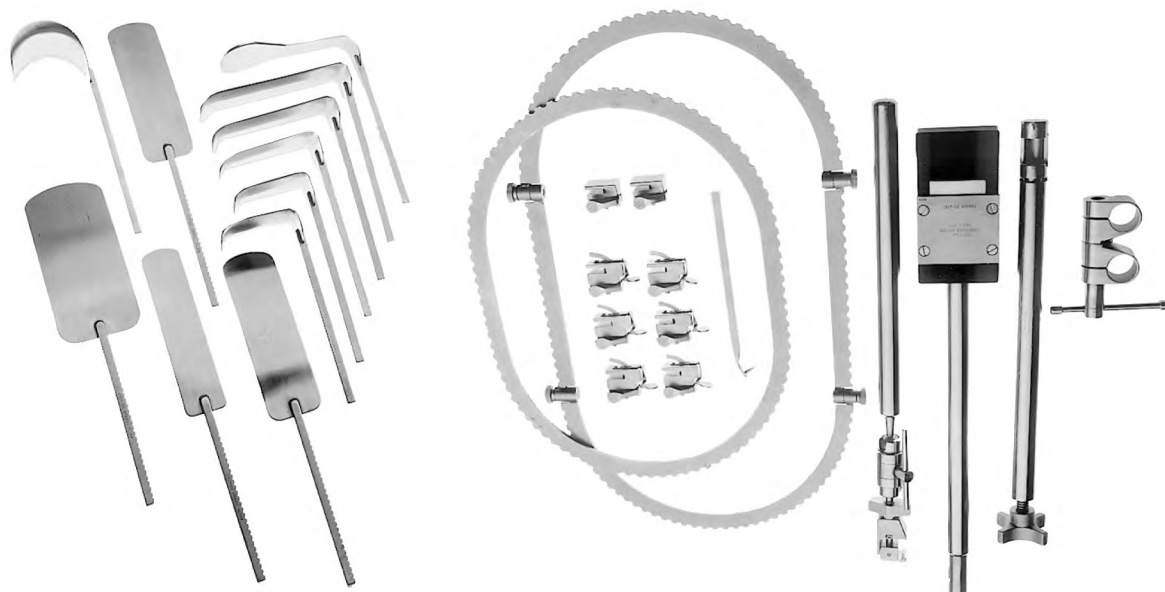

Bookwalter® Retractor Kit II

CODE	DESCRIPTION	QUANTITY
50-4542	Includes Part Numbers and Quantities Listed Below:	
50-4581	Table Post	1
50-4554	Post Coupling	1
50-4552	Horizontal Bar	1
50-4582	Horizontal Flex Bar	1
50-4557	Medium Oval Ring	1
50-4583	Segmented Ring	1
50-4579	Ratchet Mechanisms	2
50-4580	Tilt Ratchet Mechanisms	6
50-4579	Ratchet Mechanisms	2
50-4580	Tilt Ratchet Mechanisms	6
50-4566	Harrington Retractor	1
50-4576	Balfour Retractor	1
50-4568	Kelly Retractors, 2 x 3 in (51 x 76 mm)	2
50-4569	Kelly Retractor, 2 x 4 in (51 x 102 mm)	1
50-4570	Kelly Retractor 2 x 5 in (51 x 127 mm)	1
50-4571	Kelly Retractor 2 x 6 in (51 x 152 mm)	1
50-4562	Malleable Retractor 1 ½ x 6 in (38 x 152 mm)	1
50-4561	Malleable Retractors, 2 x 6 in (51 x 152 mm)	2
50-4567	Malleable Retractor 3 x 6 in (76 x 152 mm)	1
50-4577	Gelpi Retractor	1
ACCESSORIES		
50-4507	Table Fixation & Ring Case	1
50-4508	Blade & Accessories Case	1

Retractors (Bookwalter® Kits)

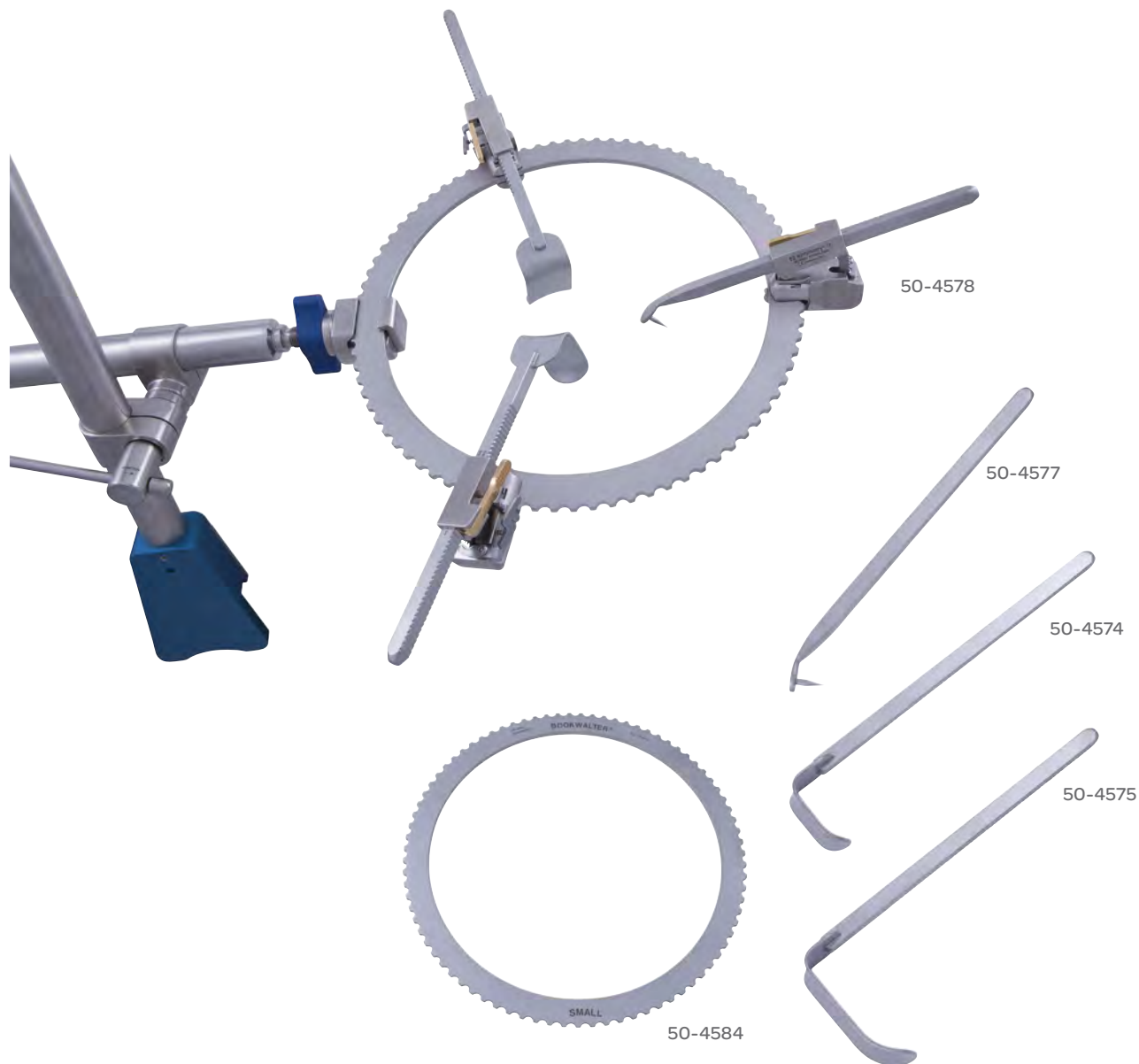

Bookwalter® Small Incision Kit

CODE	DESCRIPTION	LENGTH
50-4578	Includes Part Numbers Below:	
50-4584	Round Ring	8½ in 216 mm
50-4577	Retractor Gelpi Blade	
50-4574	Kelly Retractor Blades	1x1½ in 25x38 mm
50-4575	Kelly Blade	1x2½ in 25x64 mm

Note: Bookwalter® Small Incision Kit, does not include: Bookwalter® Table Post, Bookwalter® Coupler, Bookwalter® Horizontal Bar or Bookwalter® Ratchets.

Retractors (Bookwalter® Kits)

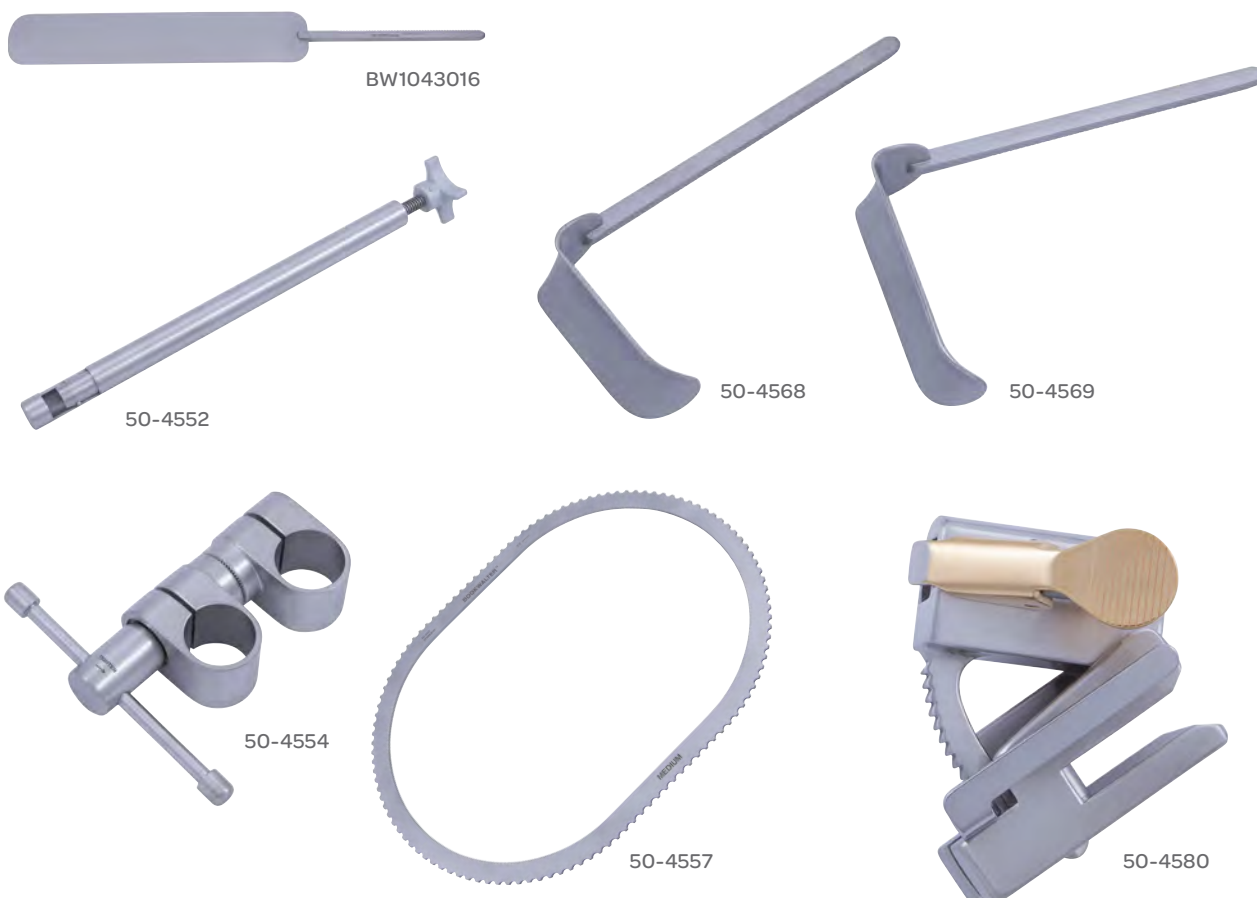

Bookwalter® Obese Patient Retractor System, 18 Inch (258 mm) Table Post

CODE	DESCRIPTION	LENGTH		QUANTITY
BW1046BKIT	Includes Part Numbers Listed Below:			
BW0144005	Table Post Obese Patients			1
BW1043016	Malleable Blade	2 x 10 in	51 x 254 mm	1
BW1043029	Malleable Blade	3 x 10 in	76 x 254 mm	1
BW1045069	Malleable Blade	4 x 8 in	102 x 203 mm	1
BW1045000	Kelly Blade	2 x 8 in	51 x 203 mm	1
BW1271017	Balfour Blade	3 ½ x 2 ¾ in	89 x 70 mm	1
BW1045176	Harrington Blade	3 ½ x 10 in	89 x 254 mm	1
BW0338014	Ratchet Extender			1
BW0338015	Twister Ratchet			1
50-4552	Retractor Horizontal Bar			1
50-4554	Post Coupling	1 x 1 in	25 x 25 mm	1
50-4557	Retractor, Oval Ring Medium			1
50-4568	Kelly Retractor Blades	2 x 3 in	51 x 76 mm	1
50-4569	Kelly Retractor Blades	2 x 4 in	51 x 102 mm	1
50-4580	Tilting Ratchets			6

Retractors (Bookwalter® Kits)

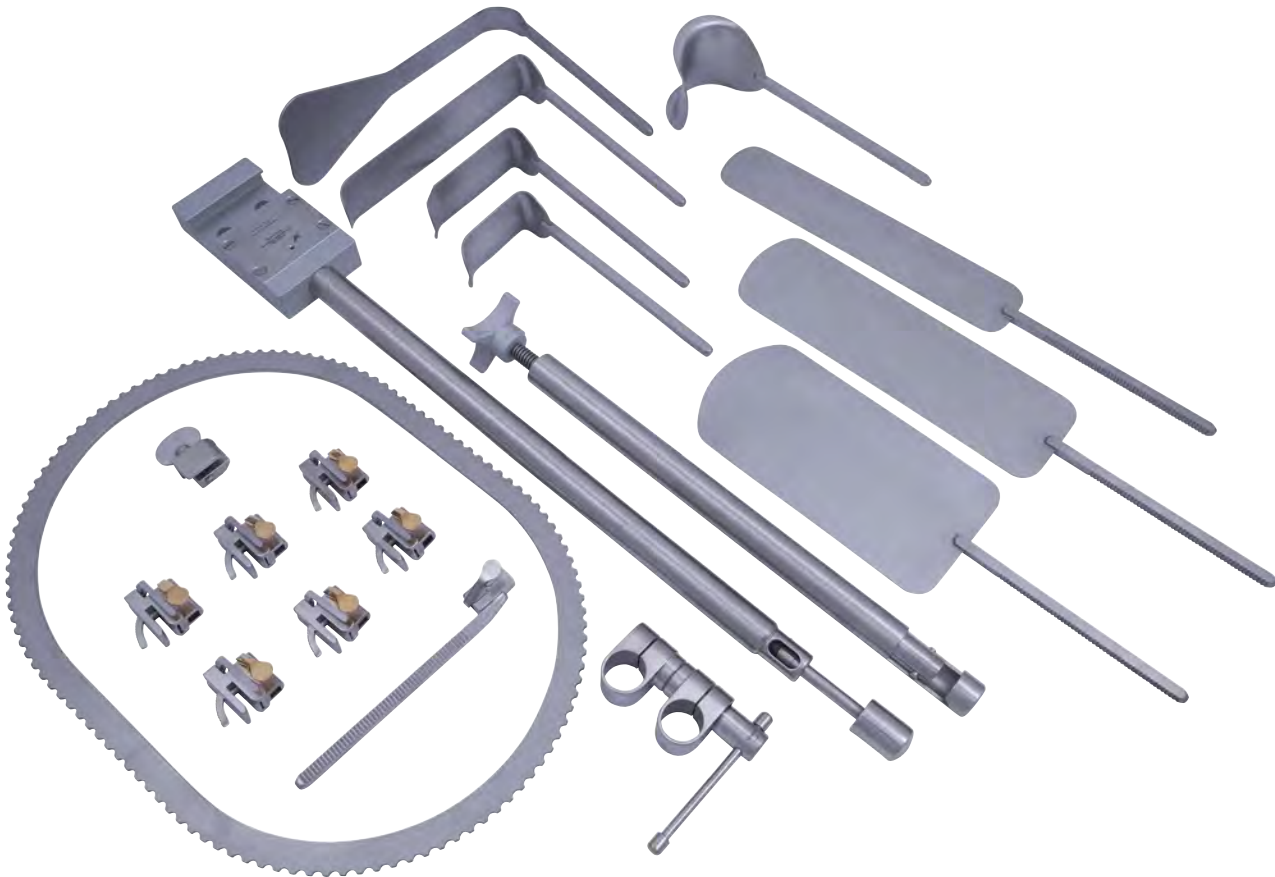

Bookwalter® Obese Patient Retractor System, 24 Inch (610 mm) Table Post

CODE	DESCRIPTION	LENGTH	QUANTITY
BW1045BKIT	Includes Part Numbers Listed Below:		
BW0144003	Table Post		1
BW1043016	Malleable Blade	2 x 10 in 51 x 254 mm	1
BW1043029	Malleable Blade	3 x 10 in 76 x 254 mm	1
BW1045069	Malleable Blade	4 x 8 in 102 x 203 mm	1
BW1045000	Kelly Blade	2 x 8 in 51 x 203 mm	1
BW1271017	Balfour Blade	3½ x 2¾ in 89 x 70 mm	1
BW1045176	Harrington Blade	3½ x 10 in 89 x 254 mm	1
BW0338014	Ratchet Extender		1
BW0338015	Twister Ratchet		1
50-4552	Horizontal Bar		1
50-4554	Post Coupling	1 x 1 in 25 x 25 mm	1
50-4557	Medium Oval Ring		1
50-4568	Kelly Blade	2 x 3 in 51 x 76 mm	1
50-4569	Kelly Blade	2 x 4 in 51 x 102 mm	1
50-4580	Tilt Ratchets		6

Retractors (Bookwalter® Kits)



Bookwalter® Obese Patient Accessory Kit, 18 Inch (458 mm) Table Post

CODE	DESCRIPTION	LENGTH		QUANTITY
BW1046BRT	Includes Part Numbers Listed Below:			
BW0144005	Table Post	18 in	460 mm	1
BW1043016	Malleable Blade	2 x 10 in	51 x 254 mm	1
BW1043029	Malleable Blade	3 x 10 in	76 x 254 mm	1
BW1045069	Malleable Blade	4 x 8 in	102 x 203 mm	1
BW1045000	Kelly Blade	2 x 8 in	51 x 203 mm	1
BW1271017	Balfour Blade	3 ½ x 2 ¾ in	89 x 70 mm	1
BW1045176	Harrington Blade	3 ½ x 10 in	89 x 254 mm	1
BW0338014	Ratchet Extender			1
BW0338015	Twister Ratchet			1



50-4596

Bookwalter® Richardson Blade Kit

CODE	DESCRIPTION	LENGTH	
50-4596	Includes 1 each of the following:		
50-4597	Blade	¾ x 1 in	19 x 25 mm
50-4598	Blade	¾ x 2 in	19 x 50 mm
50-4599	Blade	1 x 1 ¼ in	25 x 31 mm

Retractors (Bookwalter® Ratchets)

Bookwalter® Ratchet Mechanism

CODE	DESCRIPTION	QTY
50-4579	Basic Ratchet provides simple retraction at 0° angle to the surgical site.	1/Each Sold Individually



Bookwalter® Tilt Ratchet Mechanism

CODE	DESCRIPTION	QTY
50-4580	Tilt ratchet articulates the blade into the surgical site.	1/Each Sold Individually



Retractors (Bookwalter® Ratchets)

Bookwalter Rotilt® Ratchet

CODE	DESCRIPTION	QTY
50-4589	The RoTilt Ratchet twists the blade in 7 indexed positions along a 60° arch and has the ability to independently articulate the blade into the surgical site.	1/Each Sold Individually



Bookwalter® Self-Retaining Tilt Ratchet

CODE	DESCRIPTION	QTY
50-4686	Like the 50-4580 this ratchet articulates the blade into the surgical site, it also has an additional self-retention latch that holds the ratchet onto the Bookwalter® Retractor Ring.	1/Each Sold Individually



Bookwalter® Self-Retaining Low Profile Locking Rotilt

CODE	DESCRIPTION	LENGTH
50-4696	The Bookwalter® Self-Retaining Low Profile Locking RoTilt Ratchet bring all of the best features of all other ratchets into one mechanism. The low profile design, inclusive of the capacity to tilt, rotate and self-retention it is the one ratchet to build your Bookwalter® Set.	1/Each Sold Individually



Retractors (Bookwalter® Ratchets)

Bookwalter® Twister Ratchet

CODE	DESCRIPTION
BW0338015	The Bookwalter® Twister Ratchet is compatible with all Bookwalter® Ratchets and Retractor Blades. It allows controlled fine tuning of blade position with the simple turn of the key.



Bookwalter® Ratchet Extender

CODE	DESCRIPTION
BW0338014	A Bookwalter® Extender provides the surgeon with the extra length that is sometimes needed to get a blade positioned in 'just the right spot'. Can be used with any Bookwalter® Retractor.

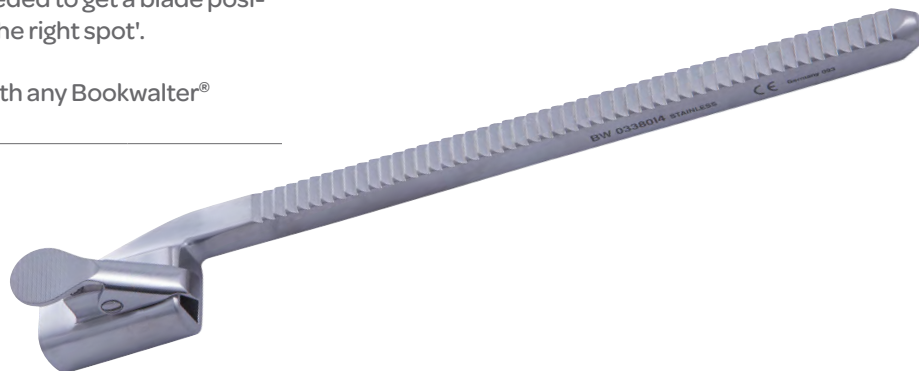

Retractors (Bookwalter® Rings)

Bookwalter® Adaptable Ring System Kit

CODE	DESCRIPTION
504810	Bookwalter® Adaptable Ring System includes the Horizontal Bar and dual ball joint hinge system as well as the Small Round, Medium Round and Medium Oval Ring Segments
504811	Small Round Ring Segments
504812	Medium Round Ring Segments
504813	Medium Oval Ring Segments

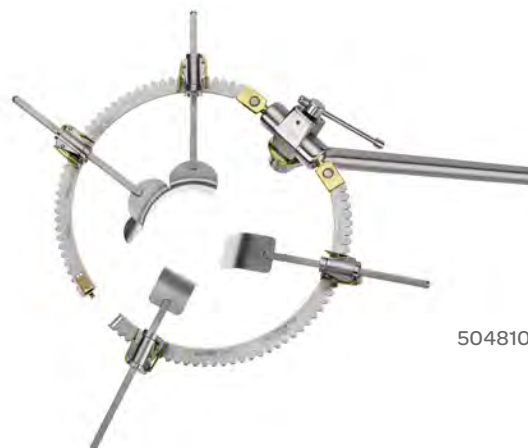

504810

Bookwalter® Adaptable Ring System Bridge

CODE	DESCRIPTION
504687	For use with 50-4810



Bookwalter® Elliptical Ring

For Obese Patients

CODE	DESCRIPTION	LENGTH
50-4595	Segmented	14 ½ in x 15 in 368 w x 381 mm



Retractors (Bookwalter® Rings)

Bookwalter® Oval Ring

CODE	DESCRIPTION	LENGTH	
50-4558	Small	8 x 12 ¼ in	203 x 311 mm
50-4557	Medium	10 ½ in x 14 ½ in	267 x 368 mm
50-4556	Large	12 x 18 ½ in	305 x 470 mm

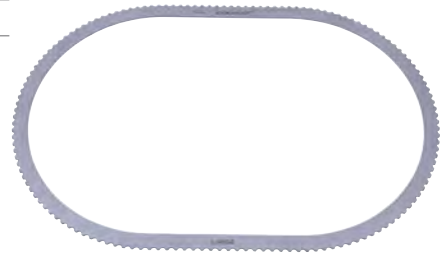

50-4556

Bookwalter® Round Ring

CODE	DESCRIPTION	LENGTH (INNER DIMENSION)	
50-4584	Small	8 ½ in	216 mm
50-4559	Medium	10 ½ in	267 mm
50-4560	Large	12 ½ in	318 mm



50-4584

Bookwalter® Segmented Round Ring

CODE	DESCRIPTION	DIAMETER	
50-4635	Small, 1 Pair	8 ½ in	216 mm
50-4634	Medium, 1 Pair	10 ½ in	267 mm
50-4633	Large, with Suture Slots	16 in	406 mm



50-4635

Retractors (Bookwalter® Rings)

Bookwalter® Round Suture Ring

CODE	DESCRIPTION	LENGTH
50-4684	Large	12½ in 318 mm



Bookwalter® Segmented Retractor Ring

CODE	DESCRIPTION	DIMENSIONS
50-4587	Small, Consists of One 8½ in (216 mm) Round Ring and Two 4 in Straight Segments	8½ x 14 in 216 x 356 mm
50-4583	Medium, Consists of One 10½ in (267 mm) Round Ring and Two 8 in Straight Segments	10½ x 19½ in 266 x 495 mm
50-4588	Large, Consists of One 12½ in (318 mm) Round Ring and Two 6 in Straight Segments	12½ x 19½ in 317 x 495 mm



50-4588

Bookwalter® Straight Ring Segments

Sold in Pairs

CODE	DESCRIPTION	LENGTH
50-4636	Straight Ring Segment	4 in 102 mm
50-4637	Straight Ring Segment	6 in 152 mm
50-4638	Straight Ring Segment	8 in 203 mm



50-4638

Retractor (Bookwalter® Table Posts)

Bookwalter® Post Holder

CODE	DESCRIPTION	LENGTH
50-4680	For Use with the Violi Gooseneck 50-4681	4 in 102 mm



Bookwalter® Table Post

CODE	DESCRIPTION	LENGTH
50-4581	Table Post	12 in 305 mm



Bookwalter® Table Post

CODE	DESCRIPTION	LENGTH
50-4683	Table Post	8 in 203 mm



Retractors (Bookwalter® Table Posts)

Bookwalter® Table Post

CODE	DESCRIPTION	LENGTH
BW0144005	Table Post	18 in 458 mm
BW0144003	Table Post	24 in 610 mm

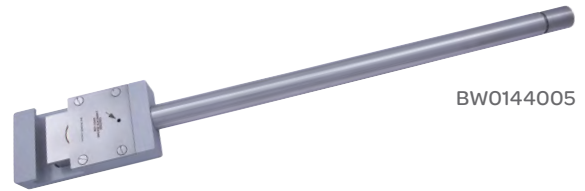

BW0144005

Bookwalter® Lightweight Table Post

CODE	DESCRIPTION	LENGTH
504688	Lightweight Table Post	12 in 305 mm
504697	Lightweight Table Post	16 in 406 mm

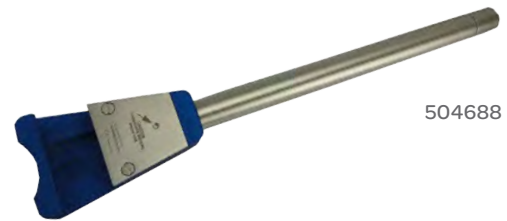

504688

Abdominal (Vision)

Ultra™ Swivel Blade

CODE	LENGTH	DIAMETER
59-8816A	12 in	1 in 25 mm



Ultra™ Blade Loading Locking Retractor Handle

CODE	LENGTH
59-0105	8 in 203 mm



Retractors (Universal Ring Retractor)

Universal Ring Big Boy Retractor Blade

CODE	DESCRIPTION	LENGTH	
58-0021	Fenestrated Blade	18 in	458 mm
58-0020	Fenestrated Blade	24 in	610 mm



58-0020

Universal Ring Harrington Retractor Blade

CODE	DESCRIPTION	LENGTH	
58-0035	Solid	$\frac{2}{3} \times 2\frac{1}{4}$ in	17 mm x 57 mm
58-0037	Solid	$3 \times 10\frac{1}{2}$ in	76 x 267 mm



58-0035

Retractors (Universal Ring Retractor)

Universal Ring Kelly Retractor Blade

CODE	DESCRIPTION	LENGTH	
58-0025	Stainless, Matte Finish	1 x 3 in	25 x 76 mm
58-0009	Stainless, Matte Finish	2½ x 5 x 3½ in	64 x 127 x 89 mm
58-0017T	Titanium	2½ x 8 x 3½ in	64 x 203 x 89 mm
58-0016T	Titanium	3 x 10½ in	76 x 267 mm



58-0009

Universal Ring Meyering Retractor Blade

Titanium

CODE	LENGTH	
58-0048T	2 x 4 in	51 x 102 mm
58-0051T	2½ x 3 in	64 x 76 mm



58-0048T

Universal Ring Pediatric Harrington Retractor Blade

CODE	LENGTH
58-0036	2 x 8 in 50 x 203 mm

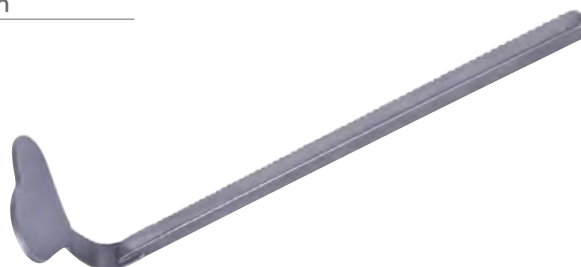

Retractors (Bookwalter®)

Universal Ring Retractor Blade

Titanium

CODE	DESCRIPTION	DIMENSIONS	
58-0073	Fence, Rigid	2 x 3 ³ / ₄ in	51 x 95 mm
58-0044T	Titanium	3 ¹ / ₂ x 3 ³ / ₄ in	89 x 95 mm



58-0073

Universal Ring Yu-Holtgrew Retractor Blade

CODE	DESCRIPTION	LENGTH
58-0022	Fence, Rigid	4 x 5 in 102 x 127 mm

Universal Ring Retractor Blade

CODE	DESCRIPTION	LENGTH	
58-0042	Malleable, With Lip	3/4 x 4 in	19 x 102 mm
58-0045	Malleable, With Lip	1/2 x 4 in	13 x 102 mm
58-0049	Malleable, With Lip	1 x 5 in	25 x 127 mm
58-0054	Malleable, With Lip	2 x 8 in	51 x 203 mm
58-0056	Malleable, With Lip	3 x 8 in	76 x 203 mm
58-0057N	Malleable, With Lip	6 x 9 in	152 x 229 mm
58-0044N	Malleable, With Lip	6 x 12 in	152 x 305 mm

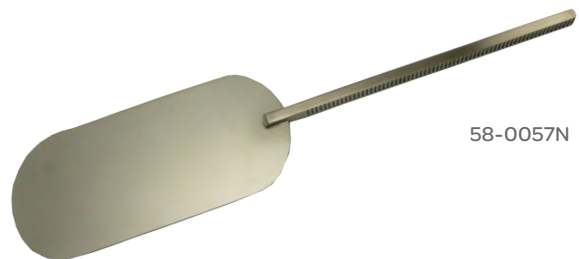

58-0057N

Retractors (Vision)

Ultra™ Mayo Swivel Blade

CODE	DESCRIPTION	LENGTH
59-8807A	Malleable, Lip	2 x 6 in 51 x 152 mm



Ultra™ Side Loading Longitudinal Retractor

CODE	DESCRIPTION	LENGTH
59-0101	Segmented	14 x 15 in 356 x 381 mm



Ultra™ Side Loading Transverse Retractor

CODE	LENGTH
59-0100	2 3/4 x 2 in 70 x 51 mm



Retractors (Vision)



Vision Retractor System

CODE	DESCRIPTION	DIMENSIONS		QTY
59-8850	System, Includes The Following Items:			
59-8802	Table Clamp with Vertical Post			1
59-8803	Retractor Clamp			6
59-8805	Vision Frame			1
59-8807	Mayo Swivel	2 3/4 x 2 in	70 x 51 mm	2
59-8809	Deaver Swivel	2 3/4 x 4 1/2 in	70 x 114 mm	1
59-8811	Harrington "Sweetheart"	2 x 5 in	51 x 127 mm	1
59-8813	Kelly Swivel "Modified"	3 x 2 1/2 in	76 x 64 mm	1
59-8814	Kelly Swivel "Modified"	3 x 4 in	76 x 102 mm	1
59-8815	Malleable Swivel, Perforated	3 x 6 in	76 x 152 mm	1
59-8816	Malleable Swivel, Perforated	3 x 6 1/2 in	76 x 165 mm	1
59-8818	Fence Swivel, Perforated	4 x 6 in	102 x 152 mm	1
59-8821	Splanchnic Swivel	2 x 6 in	51 x 152 mm	1
59-8828	Sterilization Case			1

Note: Individual components are available, in single quantities, by referencing their unique product code upon ordering.

Retractors (Vision)

Vision Retractor System

CODE	DESCRIPTION	DIMENSIONS		QTY
59-8855	System Includes The Following Items:			
59-8802	Table Clamp with Vertical Post			1
59-8803	Retractor Clamp			8
59-8804	Extension Arm, Hinged			1
59-8805	Vision Frame			1
59-8807	Mayo Swivel	2 ³ / ₄ x 2 in	70 x 51 mm	2
59-8809	Deaver Swivel	2 ³ / ₄ x 4 ¹ / ₂ in	70 x 114 mm	1
59-8811	Harrington "Sweetheart"	2 x 5 in	51 x 127 mm	1
59-8813	Kelly Swivel "Modified"	3 x 2 ¹ / ₂ in	76 x 64 mm	1
59-8814	Kelly Swivel "Modified"	3 x 4 in	76 x 102 mm	1
59-8815	Malleable Swivel, Perforated	3 x 6 in	76 x 152 mm	1
59-8816	Malleable Swivel, Perforated	3 x 6 ¹ / ₂ in	76 x 165 mm	1
59-8818	Fence Swivel, Perforated	4 x 6 in	102 x 152 mm	1
59-8821	Splanchnic Swivel	2 x 6 in	51 x 152 mm	1
59-8828	Sterilization Case			1

Note: Individual components are available, in single quantities, by referencing their unique product code upon ordering.

Retractors (Laparoscopic)



24-1800

Fan Retractor

CODE	DESCRIPTION	LENGTH	
24-1800	Pressure Lock Handle, 60° Opening 10 mm 60 mm	9 ¹ / ₂ in	241 mm
32-1800	Pressure Lock Handle, 60° Opening 10 mm 60 mm	12 ³ / ₅	320 mm
38-1800	Pressure Lock Handle, 60° Opening 10 mm 60 mm	15 in	381 mm
45-1800	Pressure Lock Handle, 60° Opening 10 mm 60 mm	17 ³ / ₄	450 mm

Retractors (Laparoscopic)

Fan Retractor

Pressure Lock Handle

CODE	DESCRIPTION	LENGTH
24-1800R	60° Opening 10 mm 60 mm	9½ in 240 mm
32-1800R	60° Opening 10 mm 60 mm	12¾ 320 mm
38-1800R	60° Opening 10 mm 60 mm	15 in 380 mm
45-1800R	60° Opening 10 mm 60 mm	17¾ 450 mm

Fan Retractor

CODE	DESCRIPTION	LENGTH
90-9800	Curve 5.0 mm	6¼ in 155 mm

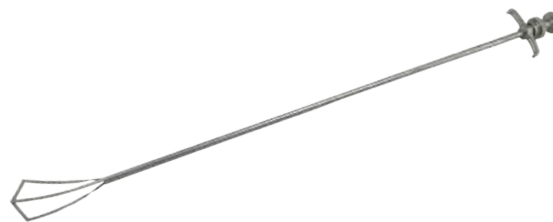

Liver Fan Retractor

Pressure Lock Handle

CODE	DESCRIPTION
68-1590	5.0 mm
68-1591	10 mm
68-1593	5.0 mm Adjustable
68-1594	10 mm Adjustable



Bookwalter® Telescopic Laparoscopic Holder

CODE	DESCRIPTION	LENGTH
504685	Telescopic with Instrument holder for instruments, trocars and laparoscopic retractors 5.0 mm - 17 mm.	



Retractors (Laparoscopic)

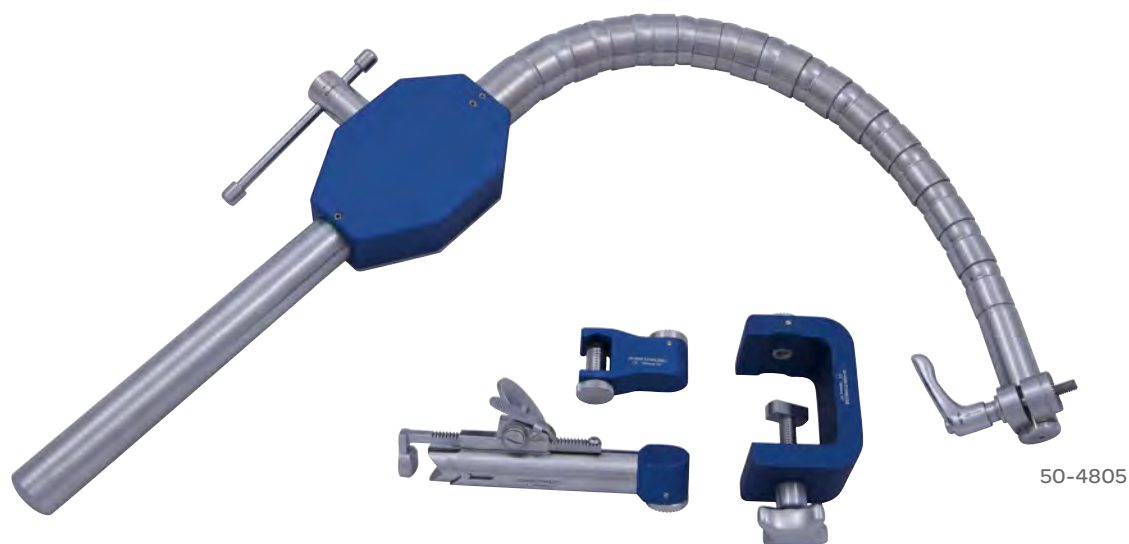

Bookwalter® Universal Flex Arm System

CODE	DESCRIPTION
50-4805	Includes Part Numbers Below:
50-4806	Ring Adapter for Bookwalter® Flex Arm
50-4807	Lap Instrument Adapter (Spring) for Bookwalter® Flex Arm
50-4808	Camera Lens Adapter for Bookwalter® Flex Arm
50-4809	Camera Housing Adapter for Bookwalter® Flex Arm

Retractors (Laparoscopic)



50-4507

Bookwalter® Table Fix & Ring Case, 12 In (305 mm) Post

CODE	DESCRIPTION
50-4507	Designed to Hold the Following Bookwalter® Components:
50-4581	Table Post
50-4582	Horizontal Flex Bar
50-4552	Retractor Horizontal Bar
50-4583	Medium Segmented Ring
50-4557	Retractor, Oval Ring Medium

For other specialty instrument holders and container systems please speak to your Symmetry Surgical Representative.

Retractors (Cerebellar)

Adson Cerebellar Retractor

4 x 4 Prongs

CODE	DESCRIPTION	LENGTH
24-2801	Sharp	7½ in 191 mm
24-2802	Straight Arms, Sharp	7½ in 191 mm

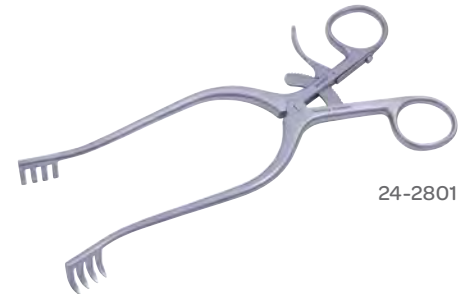

24-2801

Miskimon Cerebellar Retractor

7 x 7 Prongs, Sharp, Angled Arms

CODE	BLADE DEPTH	LENGTH
24-2810	1¼ in 32 mm	8¾ in 222 mm



Retractors (Epicardial)

Meyerding Finger Retractor

CODE	DESCRIPTION	LENGTH
20-1004	#4, Single Ring	7⅞ in 181 mm
20-1005	#5, Single Ring	7⅞ in 181 mm
20-1006	#6, Single Ring	7⅞ in 181 mm



20-1004

Retractors (Gall Bladder)

Foss Gall Bladder Retractor

CODE	DESCRIPTION	WIDTH		LENGTH	
23-6300	Bladder Retractor	1¾ in	44 mm	10 in	254 mm



Murphy Gall Bladder Retractor

CODE	DESCRIPTION	WIDTH		LENGTH	
23-6292	Bladder Retractor	2 in	51 mm	11 in	279 mm



Allison's Lung Retractor

CODE	DESCRIPTION	LENGTH
50-8152	Adult, Small	10½ in 267 mm
50-8153	Adult, Large	12½ in 318 mm

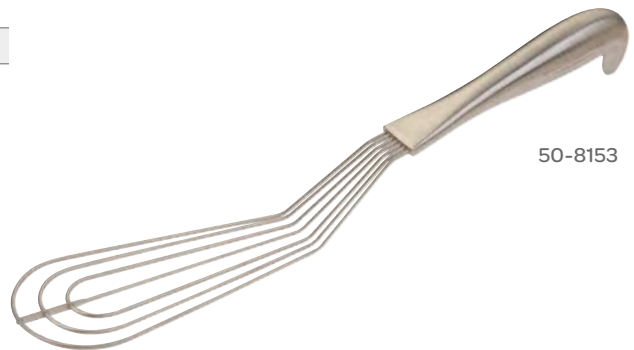

50-8153

Retractors (Hand-Held)

Meyering Finger Retractor

Single Ring

CODE	DESCRIPTION	LENGTH	CODE	DESCRIPTION	LENGTH
20-1001	#1	7 1/8 in 181 mm	20-1004	#4	7 1/8 in 181 mm
20-1002	#2	7 1/8 in 181 mm	20-1005	#5	7 1/8 in 181 mm
20-1003	#3	7 1/8 in 181 mm	20-1006	#6	7 1/8 in 181 mm



20-1001

Volkman Finger Retractor

CODE	DESCRIPTION	LENGTH	CODE	DESCRIPTION	LENGTH
22-2602	2 Prong, Sharp	4 1/2 in 114 mm	27-2702	2 Prong, Blunt	4 1/2 in 114 mm
22-2603	3 Prong, Sharp	4 1/2 in 114 mm	22-2703	3 Prong, Blunt	4 1/2 in 114 mm
22-2604	4 Prong, Sharp	4 1/2 in 114 mm	22-2704	4 Prong, Blunt	4 1/2 in 114 mm
22-2606	6 Prong, Sharp	4 1/2 in 114 mm	22-2706	6 Prong, Blunt	4 1/2 in 114 mm



22-2603

Flexible Neck Retractor

CODE	DESCRIPTION	LENGTH	CODE	DESCRIPTION	LENGTH
20-6452	2 Prong, Sharp	6 1/4 in 159 mm	20-6552	2 Prong, Blunt	6 1/4 in 159 mm
20-6453	3 Prong, Sharp	6 1/4 in 159 mm	20-6553	3 Prong, Blunt	6 1/4 in 159 mm



20-6453

Retractors (Hand-Held)

Baby Deaver Retractor

CODE	DESCRIPTION	BLADE (W X D)		LENGTH	
50-5630	Standard Handle	$\frac{5}{8}$ x 2 $\frac{1}{2}$ in	16 x 64 mm	8 in	203 mm
50-5631	Standard Handle	1 x 2 $\frac{1}{2}$ in	25 x 64 mm	8 in	203 mm

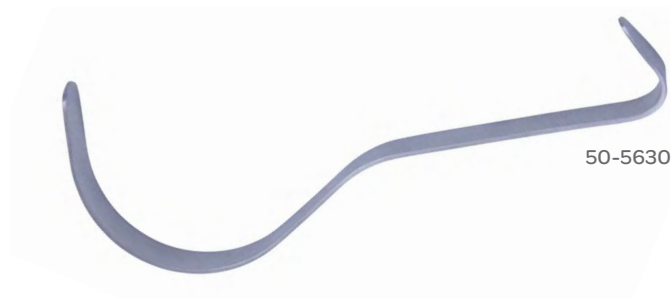

Blade Retractor

CODE	WIDTH	LENGTH	HANDLE LENGTH		CODE	WIDTH	LENGTH	HANDLE LENGTH	
50-1050	18 mm	3 in 76 mm	4 $\frac{1}{2}$ in	114 mm	50-1053	23 mm	3 in 76 mm	4 $\frac{1}{2}$ in	114 mm
50-1052	20 mm	3 in 76 mm	4 $\frac{1}{2}$ in	114 mm					



Boley Retractor

CODE	DESCRIPTION	BLADES (W X D)		LENGTH	
50-5608	#1, Double-Ended	$\frac{1}{2}$ x $\frac{1}{2}$ in	13 x 13 mm	6 $\frac{1}{4}$ in	159 mm
		$\frac{7}{16}$ x $\frac{7}{16}$ in	11 x 11 mm		



Retractors (Hand-Held)

Campbell Nerve Root Retractor

CODE	DESCRIPTION	BLADE WIDTH	LENGTH
50-1326	Malleable Shaft	$\frac{3}{8}$ in 10 mm	8 $\frac{1}{2}$ in 216 mm



Children's Hospital Retractor

CODE	DESCRIPTION	BLADE (W X D)	LENGTH
50-4100	Small, Double-Ended	$\frac{7}{16} \times \frac{7}{8}$ in 11 x 22 mm $\frac{9}{16} \times 1\frac{3}{8}$ in 14 x 35 mm	5 $\frac{1}{2}$ in 140 mm



Children's Hospital Retractor

CODE	DESCRIPTION	BLADE (W X D)	LENGTH
50-5645	S-Shaped, Double-Ended	$\frac{1}{4} \times \frac{3}{4}$ in 6.0 x 19 mm $\frac{1}{2} \times \frac{3}{4}$ in 13 x 19 mm	4 $\frac{7}{8}$ in 124 mm



Retractors (Hand-Held)

Collins Retractor

CODE	DESCRIPTION	LENGTH	QTY
22-1215	Double-Ended	6½ in 165 mm	Set of 2



Crile Retractor

CODE	DESCRIPTION	BLADE (W X D)	LENGTH
50-4105	Double-Ended	¼ x ¾ in	6.0 x 19 mm
		⅜ x ⅝ in	5.0 x 16 mm



Cushing Decompression Retractor

CODE	DESCRIPTION	SIZE (W X D)	LENGTH
50-1060	Fenestrated Blade	½ in x ⅞ in 13 x 22 mm	8⅜ in 213 mm



Cushing Retractor

CODE	JAW LENGTH	LENGTH	CODE	JAW LENGTH	LENGTH
32-3633	1.0 cm	11 in 279 mm	32-3634	1.1 cm	14 in 356 mm



32-3633

Retractors (Hand-Held)

Cushing Vein Retractor

CODE	DESCRIPTION	BLADE (W X D)	LENGTH
50-1020	Vein Retractor	13 x 10 mm	9 in 229 mm
50-1022	Vein Retractor	9 x 6 mm	7 ³ / ₄ in 197 mm
20-1750	Fenestrated Handle	11 mm	9 in 229 mm
20-1752	Fenestrated Handle	11 mm	14 in 356 mm



Davidson Scapular Retractor

CODE	DESCRIPTION	BLADE (W X D)	LENGTH
50-8096	Scapular Retractor	3 ¹ / ₂ x 3 in 89 x 76 mm	6 in 152 mm



Davis Retractor

CODE	DESCRIPTION	BLADES (W X D)	LENGTH
20-0510	Retractor	6.0 x 17 mm, 9.0 x 20 mm	6 in 152 mm



Retractors (Hand-Held)

Deaver Baby Retractor

CODE	DESCRIPTION	WIDTH		LENGTH	
23-7500	Standard Handle	3/8 in	10 mm	7 in	176 mm
23-7217	Standard Handle	1/16 in	17 mm	8 in	203 mm
23-7225	Standard Handle	1 in	25 mm	8 in	203 mm



23-7217

Deaver Retractor

CODE	DESCRIPTION	WIDTH		LENGTH	
23-7211	Ring-Grip Handle	1 in	25 mm	12 in	305 mm
23-7212	Ring-Grip Handle	1 in	25 mm	12 in	305 mm
23-7213	Ring-Grip Handle	1 1/2 in	38 mm	12 in	305 mm
23-7214	Ring-Grip Handle	2 in	51 mm	12 in	305 mm
23-7215	Ring-Grip Handle	3 in	76 mm	12 in	305 mm
23-7216	Ring-Grip Handle	4 in	102 mm	12 in	305 mm
23-7218	Ring-Grip Handle	2 in	51 mm	15 in	305 mm
23-7221	Ring-Grip Handle	1 in	25 mm	16 in	405 mm



23-7211

Deaver Retractor

Standard Handle

CODE	WIDTH	LENGTH	CODE	WIDTH	LENGTH
23-7501	3/4 in 19 mm	7 in 178 mm	23-7504	1 in 25 mm	12 in 305 mm
23-7502	7/8 in 22 mm	8 1/2 in 216 mm	23-7505	1 in 25 mm	12 in 305 mm
23-7503	1 in 25 mm	9 1/4 in 235 mm	23-7507	1 1/2 in 38 mm	12 in 305 mm
23-7244	1 in 25 mm	10 in 254 mm	23-7508	2 in 51 mm	12 in 305 mm
			23-7218	2 in 51 mm	15 in 381 mm



23-7244

Retractors (Hand-Held)

Deaver Retractor

Standard Handle

CODE	DESCRIPTION	WIDTH		LENGTH	
50-4303	#1	1 in	25 mm	12 in	305 mm
50-4304	#2	1 in	25 mm	12 in	305 mm
50-4306	#3	1½ in	38 mm	12 in	305 mm
50-4307	#4	2 in	51 mm	12 in	305 mm
50-4308	#5	3 in	76 mm	12 in	305 mm



50-4307

Deaver Retractor

CODE	DESCRIPTION	WIDTH		LENGTH	
50-4316	#1, Ring-Grip Handle	1 in	25 mm	12 in	305 mm
50-4320	#4, Ring-Grip Handle	2 in	51 mm	12 in	305 mm



50-4316

Bariatric Deaver Retractor

CODE	DESCRIPTION	BLADE LENGTH		HANDLE LENGTH	
32-3635	Deaver Retractor	2½ in	64 mm	14½ in	368 mm



D'Errico Nerve Root Retractor

CODE	DESCRIPTION	BLADE WIDTH		LENGTH	
50-1270	Nerve Root Retractor	¼ in	6.0 mm	9 in	229 mm



Retractors (Hand-Held)

Dural Suction Retractor

CODE	ANGLE	HANDLE LENGTH		TIP DEPTH		TIP WIDTH		WORKING DISTANCE	
46-3012	90°	4 ⁵ / ₈ in	117 mm	¹ / ₄ in	6.0 mm	⁹ / ₃₂ in	8.0 mm	4 ³ / ₄ in	121 mm



Farabeuf Baby Retractor

CODE	DESCRIPTION	LENGTH		QTY
22-1015	Double-Ended	6 in	152 mm	Set of 2



Flexible Nerve Root Retractor

CODE	DESCRIPTION	BLADE LENGTH		BLADE WIDTH		LENGTH	
50-1209	Nerve Root Retractor	1 in	25 mm	⁵ / ₁₆ in	8.0 mm	8 ¹ / ₂ in	216 mm



Retractors (Hand-Held)

Goelet Retractor

CODE	DESCRIPTION	BLADE (W X D)		LENGTH
23-3752	Double-Ended	1¼ x 1 in	32 x 25 mm	7½ in 191 mm
		1⅝ x 1¼ in	41 x 32 mm	
50-4095	Double-Ended	1¼ x 1 in	32 x 25 mm	7½ in 191 mm
		1⅝ x 1¼ in	41 x 32 mm	



50-4095

Green Retractor

CODE	DESCRIPTION	LENGTH
23-3512	Fenestrated Blade	8½ in 216 mm



Greene Thyroid Retractor

CODE	DESCRIPTION	BLADE (W X D)		LENGTH
50-4297	Fenestrated Blade	1⅛ x 1 in	17 x 25 mm	8¾ in 222 mm



Harrington-Pemberton Retractor

CODE	DESCRIPTION	SIZE		LENGTH
23-7040	Retractor	1⅝ x 5 in	41 x 127 mm	12½ in 318 mm
23-7106	Retractor	2½ x 7⅛ in	64 x 181 mm	12½ in 318 mm



23-7040

Retractors (Hand-Held)

Harrington Splanchnic Retractor

CODE	DESCRIPTION	BLADE WIDTH		LENGTH	
50-8102	Splanchnic Retractor	2½ in	64 mm	12½ in	318 mm



Hayes Hand Retractor

CODE	DESCRIPTION	BLADE WIDTH		LENGTH	
20-1776	Hand Retractor	3.0 mm		6¼ in	159 mm
20-1777	Hand Retractor	6.0 mm		6¼ in	159 mm



20-1776

Heiss Retractor

4 x 4 Prongs, Cross-Action

CODE	DESCRIPTION	LENGTH	CODE	DESCRIPTION	LENGTH
24-0909	Sharp	4 in 102 mm	24-0910	Blunt	4 in 102 mm
24-0911	Sharp	4 in 102 mm	24-0912	Blunt	4 in 102 mm



24-0909

Hibbs Retractor

CODE	DESCRIPTION	BLADE DEPTH		SIZE (W X D)		LENGTH	
23-6381	Sharp Teeth	1 in	25 mm	1 x 3 in	25 x 76 mm	9½ in	241 mm
23-6382	Sharp Teeth	1 in	25 mm	1 x 3¾ in	25 x 95 mm	9½ in	241 mm
50-2558C	Double-Ended, Set Two	2 in	51 mm	1 x ¾ in	25 x 19 mm	9½ in	241 mm



23-6381

Retractors (Hand-Held)

Hohmann Retractor

CODE	DESCRIPTION	WIDTH	LENGTH
77-1118	Retractor	18 mm	9½ in 241 mm



Israel Retractor

CODE	DESCRIPTION	PRONGS	BLADES (W X D)	LENGTH
50-4246	Blunt	4 Prong	1¾ x 1¾ in 44 x 44 mm	7¾ in 197 mm
22-7204	Blunt	4 Prong	1½ x 1½ in 38 x 38 mm	10 in 254 mm
22-7205	Blunt	5 Prong	2 x 1¾ in 51 x 44 mm	10 in 254 mm
22-7206	Blunt	6 Prong	2¾ x 2 in 60 x 51 mm	10 in 254 mm



Kasdan Hand Retractor

CODE	DESCRIPTION	BLADE WIDTH	LENGTH
20-0540	Double-Ended		6¼ in 159 mm



Retractors (Hand-Held)

Kelly Retractor

CODE	DESCRIPTION	BLADE (W X L)		LENGTH	
23-4701	Standard Handle	1½ x 2 in	35 x 51 mm	10¼ in	260 mm
23-4702	Standard Handle	2 x 2½ in	51 x 64 mm	10¼ in	260 mm
23-4703	Standard Handle	2½ x 3 in	64 x 76 mm	10¼ in	260 mm
23-4711	Lamb Handle	1¼ x 2 in	32 x 51 mm	10¼ in	260 mm
23-4712	Lamb Handle	2 x 2½ in	51 x 64 mm	10¼ in	260 mm
23-4713	Lamb Handle	2½ x 3 in	64 x 76 mm	10¼ in	260 mm
23-4714	Lamb Handle	3 x 3½ in	76 x 89 mm	10¼ in	260 mm
23-4715	Ring-Grip Handle	1½ x 2 in	38 x 51 mm	10¼ in	260 mm
23-4716	Ring-Grip Handle	2 x 2½ in	51 x 64 mm	10¼ in	260 mm
23-4717	Ring-Grip Handle	2½ x 3 in	63 x 76 mm	10¼ in	260 mm
23-4718	Ring-Grip Handle	3 x 3½ in	76 x 89 mm	10¼ in	260 mm



23-4701

Kelly Retractor

Standard Handle

CODE	DESCRIPTION	BLADE (W X D)		LENGTH	
50-4110	Small	1½ x 2 in	38 x 51 mm	9¼ in	235 mm
50-4111	Medium	2 x 2½ in	51 x 64 mm	9½ in	241 mm
50-4112	Large	2½ x 3 in	64 x 76 mm	10 in	254 mm



50-4110

Kelly Retractor

Ring-Grip Handle

CODE	DESCRIPTION	BLADE (W X D)		LENGTH	
50-4115	Small	1½ x 2 in	38 x 51 mm	9¼ in	235 mm
50-4116	Medium	2 x 2½ in	51 x 64 mm	9¼ in	235 mm
50-4117	Large	2½ x 3 in	64 x 76 mm	10 in	254 mm
50-4118	XL	3 x 3½ in	76 x 89 mm	10 in	254 mm



50-4117

Retractors (Hand-Held)

Knapp Retractor

CODE	DESCRIPTION	PRONGS	WIDTH	LENGTH
20-5516	Sharp	4 Prong	6.0 mm	5 in 127 mm
20-5517	Blunt	4 Prong	6.0 mm	5 in 127 mm

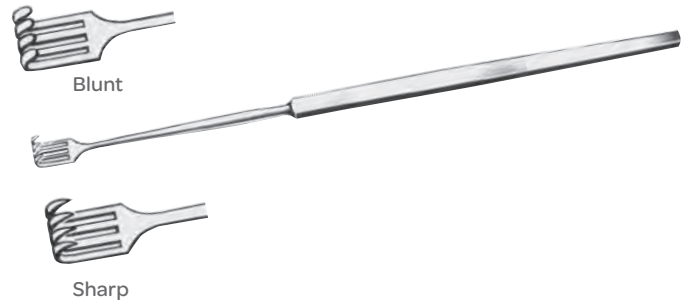

Lahey Retractor

CODE	DESCRIPTION	BLADE (W X D)	LENGTH
23-0306	Retractor		7 ³ / ₄ in 197 mm
50-4040C	Thyroid Retractor	¼ x 1 in 6.0 x 25 mm	8 ¹ / ₈ in 206 mm

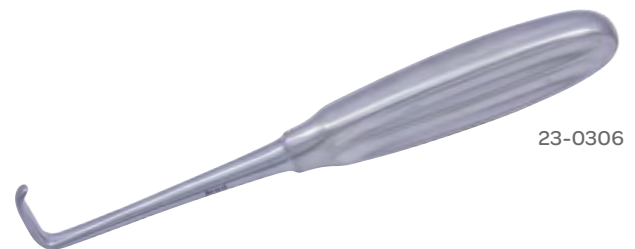

Langenbeck Retractor

CODE	DESCRIPTION	BLADE (W X D)	LENGTH
23-0710	Hollow Handle	¾ x 1½ in 10 x 38 mm	8¾ in 222 mm
50-4255	#1	¾ x 1⅝ in 10 x 41 mm	8¾ in 210 mm
50-4256	#2	½ x 1⅝ in 13 x 41 mm	8¾ in 210 mm



Retractors (Hand-Held)

Love Nerve Root Retractor

CODE	DESCRIPTION	BLADE WIDTH	SHAFT LENGTH	LENGTH
50-1315	Straight	¼ in 6.0 mm	4 in 102 mm	7 ⅝ in 194 mm
50-1316	90° Angle	¼ in 6.0 mm	4 in 102 mm	3 ¾ in 95 mm
50-1317	135° Angle	¼ in 6.0 mm	4 in 102 mm	3 ¼ in 83 mm



Mathieu Retractor

CODE	DESCRIPTION	PRONG WIDTH	BLADE WIDTH	BLADE DEPTH	LENGTH
50-4290	Double-Ended, 3 Prong, Sharp	⅜ in 10 mm	¼ in 6.0 mm	3/4 in 19 mm	6 ½ in 165 mm



Mayo Abdominal Retractor

CODE	LENGTH
23-6346 2 ¾ in 70 mm	10 in 254 mm

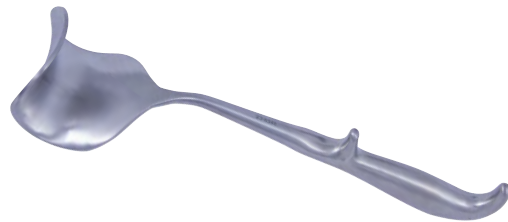

McBurney Thyroid Retractor

CODE	DESCRIPTION	BLADE (W X D)	LENGTH
50-4410	Fenestrated Blades	⅜ x ¾ in 10 x 19 mm	7 ⅝ in 187 mm



Retractors (Hand-Held)

Meyerding Retractor

CODE	DESCRIPTION	BLADE (W X D)		LENGTH	
23-6301	#1 Small	$\frac{5}{8}$ x 2 in	16 x 51 mm	9 in	229 mm
23-6302	#2 Medium	1 x 3 in	25 x 76 mm	9½ in	241 mm
23-6303	#3 Large	2 x 3½ in	51 x 89 mm	9½ in	241 mm



23-6301

Meyerding Laminectomy Retractor

CODE	DESCRIPTION	BLADE (W X D)		LENGTH	
50-1065	Small, Self-Retaining	$\frac{5}{8}$ x 2 in	16 x 51 mm	9 in	229 mm
50-1066	Medium, Self-Retaining	1 x 3 in	25 x 76 mm	9½ in	241 mm
50-1067	Large, Self-Retaining	2 x 3½ in	51 x 89 mm	9½ in	241 mm



50-1065

Murphy Retractor

CODE	DESCRIPTION	LENGTH
22-5004	4 Prong, Sharp	7¾ in 197 mm
50-8072	4 Prong, Sharp	7¾ in 197 mm
22-5006	6 Prong, Sharp	7¾ in 197 mm
22-5103	3 Prong, Blunt	7¾ in 197 mm
22-5104	4 Prong, Blunt	7¾ in 197 mm
22-5106	6 Prong, Blunt	7¾ in 197 mm



50-8072

Ollier Retractor

CODE	DESCRIPTION	LENGTH
22-7002	4 Prong, Blunt	8½ in 216 mm
50-4253	4 Prong, Blunt	9 in 229 mm



50-4253

Retractors (Hand-Held)

Parker Mott Retractor

CODE	DESCRIPTION	LENGTH	QTY
22-1516	Double-Ended	6½ in 166 mm	Set of 2



Parker Retractor

Double-Ended

CODE	DESCRIPTION	LENGTH	QTY
22-1413	Small	5 in 127 mm	Set of 2
50-4090	Small	5½ in 140 mm	Set of 2
22-1418	Large	7 in 176 mm	Set of 2



22-1418

Plastic Hand Retractor

CODE	DESCRIPTION	WIDTH	LENGTH
20-6102	2 Prong, Blunt	¾ in 5.0 mm	6¾ in 171 mm
20-6103	3 Prong, Blunt	⅓ in 8.0 mm	6¾ in 171 mm
20-6104	4 Prong, Blunt	⅞ in 11 mm	6¾ in 171 mm



20-6103

Plastic Hand Surgery Retractor

CODE	DESCRIPTION	DESCRIPTION	LENGTH
20-6001	9.0 mm Wide	1 Prong, Sharp	6¾ in 171 mm
20-6002	5.0 mm Wide	1 Prong, Sharp	6¾ in 171 mm
20-6003	8.0 mm Wide	3 Prong, Sharp	6¾ in 171 mm
20-6004	11 mm Wide	4 Prong, Sharp	6¾ in 171 mm



20-6002

Retractors (Hand-Held)

Ragnell Retractor

CODE	DESCRIPTION	BLADE (W X D)		LENGTH	
50-2608	Double-Ended	$\frac{1}{8} \times \frac{1}{4}$ in	3.0 x 6.0 mm	6 in	152 mm
		$\frac{1}{4} \times \frac{5}{8}$ in	6.0 x 16 mm		
20-0525	Double-Ended	$\frac{1}{8} \times \frac{1}{4}$ in	3.0 x 6.0 mm	6 in	152 mm
20-0526	Double-Ended	$\frac{1}{8} \times \frac{3}{16}$ in	3.0 x 5.0 mm	6 in	152 mm



50-2608

Ribbon Malleable Retractor

CODE	DESCRIPTION	BLADE WIDTH		LENGTH	
50-5637	Malleable, Double-Ended	$\frac{1}{2}$ in	13 mm	8 in	203 mm
50-5639	Malleable, Double-Ended	$\frac{3}{4}$ in	19 mm	8 in	203 mm
50-4210	Malleable, Double-Ended	1 in	25 mm	13 in	330 mm
50-4212	Malleable, Double-Ended	$1\frac{1}{2}$ in	38 mm	13 in	330 mm
50-4214	Malleable, Double-Ended	2 in	51 mm	13 in	330 mm



50-4212

Ribbon Retractor

Double-Ended, Malleable

CODE	WIDTH		LENGTH		CODE	WIDTH		LENGTH	
22-0006	$\frac{1}{4}$ in	6.0 mm	8 in	203 mm	22-0253	$1\frac{1}{4}$ in	32 mm	13 in	330 mm
22-0012	$\frac{1}{2}$ in	13 mm	8 in	203 mm	22-0254	$1\frac{1}{2}$ in	38 mm	13 in	330 mm
22-0017	$\frac{5}{8}$ in	16 mm	8 in	203 mm	22-0255	2 in	51 mm	13 in	330 mm
22-0025	1 in	25 mm	8 in	203 mm	22-0256	$2\frac{1}{2}$ in	64 mm	13 in	330 mm
22-0027	1 in	25 mm	10 in	254 mm	22-0257	3 in	76 mm	13 in	330 mm
22-0035	$1\frac{3}{4}$ in	44 mm	10 in	254 mm	22-0258	4 in	102 mm	13 in	330 mm
22-0251	$\frac{3}{4}$ in	19 mm	13 in	330 mm	22-0259	5 in	127 mm	13 in	330 mm
22-0252	1 in	25 mm	13 in	330 mm					

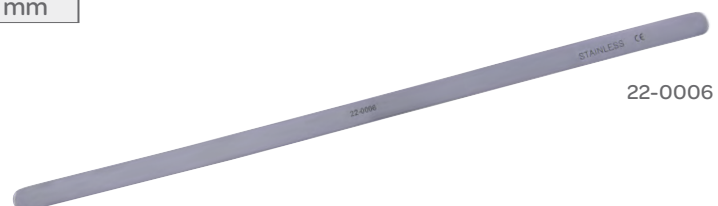

22-0006

Retractors (Hand-Held)

Richardson Appendectomy Retractor

CODE	DESCRIPTION	BLADE (W X D)	LENGTH
50-4130C	Standard Handle	$1\frac{3}{16}$ x 2 in 21 x 55 mm	9 $\frac{1}{4}$ in 235 mm
50-4131	Ring-Grip Handle	$\frac{3}{4}$ x 2 in 19 x 51 mm	9 $\frac{1}{4}$ in 235 mm



50-4130C

Richardson Retractor

CODE	DESCRIPTION	BLADE (W X D)	LENGTH
23-4501	Standard Handle	$\frac{3}{4}$ x 1 in 19 x 25 mm	9 $\frac{1}{2}$ in 241 mm
23-4502	Standard Handle	1 x 1 $\frac{1}{4}$ in 25 x 32 mm	9 $\frac{1}{2}$ in 241 mm
23-4503	Standard Handle	1 $\frac{1}{2}$ x 1 $\frac{1}{2}$ in 38 x 38 mm	9 $\frac{1}{2}$ in 241 mm
23-4504	Standard Handle	$\frac{3}{4}$ x 2 in 19 x 51 mm	9 $\frac{1}{2}$ in 241 mm
23-4505	Standard Handle	1 $\frac{5}{8}$ x 2 $\frac{1}{2}$ in 41 x 64 mm	9 $\frac{1}{2}$ in 241 mm



23-4501

Richardson Retractor

CODE	DESCRIPTION	BLADE (W X D)	LENGTH
23-4511	Lamb Handle	$\frac{3}{4}$ x 1 in 19 x 25 mm	9 $\frac{1}{2}$ in 241 mm
23-4512	Lamb Handle	1 x 1 $\frac{1}{4}$ in 25 x 32 mm	9 $\frac{1}{2}$ in 241 mm
23-4514	Lamb Handle	$\frac{3}{4}$ x 2 in 19 x 51 mm	9 $\frac{1}{2}$ in 241 mm



23-4514

Retractors (Hand-Held)

Richardson Retractor

CODE	DESCRIPTION	SIZE	BLADE (W X D)	LENGTH
23-4515	Ring-Grip Handle	Small	$\frac{3}{4}$ x 1 in 19 x 25 mm	9 $\frac{1}{2}$ in 241 mm
23-4516	Ring-Grip Handle	Medium	1 x 1 $\frac{1}{4}$ in 25 x 32 mm	9 $\frac{1}{2}$ in 241 mm
23-4517	Ring-Grip Handle	Large	1 $\frac{1}{2}$ x 1 $\frac{1}{2}$ in 38 x 38 mm	9 $\frac{1}{2}$ in 241 mm
23-4518	Ring-Grip Handle	Small	$\frac{3}{4}$ in x 2 in 19 x 51 mm	9 $\frac{1}{2}$ in 241 mm
23-4520	Ring-Grip Handle	Medium	1 $\frac{3}{16}$ x 4 in 30 x 100 mm	9 $\frac{1}{2}$ in 241 mm
50-4120	Standard Handle	Small	$\frac{3}{4}$ x 1 in 19 x 25 mm	9 $\frac{1}{4}$ in 235 mm
50-4121	Standard Handle	Medium	1 x 1 $\frac{1}{4}$ in 25 x 32 mm	9 $\frac{1}{4}$ in 235 mm
50-4122	Standard Handle	Large	1 $\frac{1}{2}$ x 1 $\frac{3}{4}$ in 38 x 44 mm	9 $\frac{1}{2}$ in 241 mm
50-4123C	Ring-Grip Handle	Small	$\frac{3}{4}$ x 1 in 19 x 25 mm	9 $\frac{1}{2}$ in 241 mm
50-4124C	Ring-Grip Handle	Medium	1 x 1 $\frac{1}{4}$ in 32 mm	9 $\frac{1}{2}$ in 241 mm
50-4125C	Ring-Grip Handle	Large	1 $\frac{1}{4}$ x 1 $\frac{1}{2}$ in 38 mm	9 $\frac{1}{2}$ in 241 mm



50-4122

Richardson-Eastman Retractor

Double-Ended

CODE	DESCRIPTION	BLADE (W X D)	LENGTH
23-4550	Set of Two	$\frac{7}{8}$ x $\frac{5}{16}$ in 22 x 8.0 mm	10 in 254 mm
23-4551	Small Only	1 $\frac{1}{2}$ x 1 $\frac{5}{8}$ in 38 x 41 mm	10 in 254 mm
23-4552	Large Only	1 $\frac{3}{16}$ x 1 $\frac{3}{16}$ in 44 x 64 mm	10 $\frac{1}{2}$ in 267 mm
50-4135C	Set of Two (Small and Large)	1 $\frac{3}{4}$ x 2 $\frac{1}{2}$ in 44 x 64 mm	10 in 254 mm

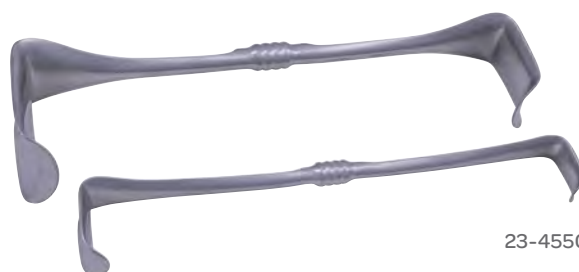

23-4550

Retractors (Hand-Held)

Rollet Lachrymal Sac Retractor

CODE	DESCRIPTION	LENGTH
50-6536	Four Prong, Sharp	5¼ in 133 mm



Roux Retractor

Double-Ended

CODE	BLADE (W X D)		LENGTH	
22-1614	7/8 x 1 1/8 in	22 x 29 mm	5 1/2 in	140 mm
22-1615	1 x 1 1/2 in	25 x 38 mm	6 in	152 mm
22-1616	1 1/4 x 1 3/4 in	32 x 45 mm	6 1/2 in	166 mm



22-1614

Sauerbruch Retractor

CODE	DESCRIPTION	BLADE (W X D)		LENGTH	
23-1501	#1	3/4 x 1 3/4 in	19 x 44 mm	9 in	229 mm
23-1502	#2	15/16 x 2 1/8 in	24 x 54 mm	9 in	229 mm
23-1503	#3	13/16 x 2 7/8 in	21 x 73 mm	9 in	229 mm



23-1501

Schoenborn Retractor

CODE	DESCRIPTION	BLADE (W X D)		LENGTH	
20-4460	13 x 6.0 mm	1/2 x 1/4 in	13 x 6.0 mm	8 in	203 mm

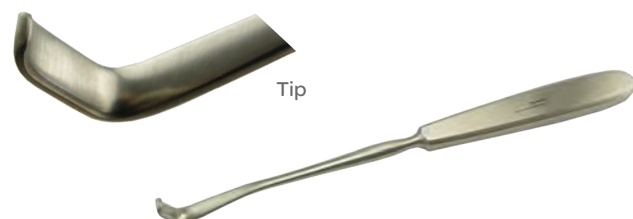

Tip

Retractors (Hand-Held)

Seeburger Retractor

CODE	LENGTH
22-0101	5½ in 140 mm



Senn Retractor

Double-Ended

CODE	DESCRIPTION	PRONG (W)	BLADE (W X D)	LENGTH
20-0508	3 Prong, Sharp	5/16 in 8.0 mm	1/4 x 3/4 in 6.0 x 19 mm	6 1/4 in 159 mm
50-4260	3 Prong, Sharp	5/16 in 8.0 mm	1/4 x 3/4 in 6.0 x 19 mm	6 7/8 in 175 mm
20-0509	3 Prong, Blunt	5/16 in 8.0 mm	1/4 x 3/4 in 6.0 x 19 mm	6 1/4 in 159 mm
50-4261	3 Prong, Blunt	5/16 in 8.0 mm	1/4 x 3/4 in 6.0 x 19 mm	6 7/8 in 175 mm



Turner-Doyen Retractor Blade

CODE	WIDTH	DEPTH	TOTAL LENGTH
32-3628	2 3/8 in (6.0 cm)	5 1/2 in 140 mm	11 1/2 in 292 mm



Retractors (Hand-Held)

US Army Retractor

CODE	DESCRIPTION	BLADE (W X D)	LENGTH
22-1821	Set of 2, Double-Ended		8 ¹ / ₄ in 210 mm
50-4071	Set of 2, Double-Ended	1 ³ / ₄ x ⁹ / ₁₆ in (44 x 14 mm) 1 ¹ / ₄ x ⁹ / ₁₆ in (32 x 14 mm)	8 ⁵ / ₁₆ in 211 mm



50-4071

Volkman Retractor

CODE	DESCRIPTION	BLADE (W X D)	LENGTH
22-3402	2 Prong, Sharp	Standard Pattern	8 ³ / ₄ in 222 mm
22-3403	3 Prong, Sharp	Standard Pattern	8 ³ / ₄ in 222 mm
22-3404	4 Prong, Sharp	Standard Pattern	8 ³ / ₄ in 222 mm
22-3406	6 Prong, Sharp	Standard Pattern	8 ³ / ₄ in 222 mm
22-3502	2 Prong, Blunt	Standard Pattern	8 ³ / ₄ in 222 mm
22-3503	3 Prong, Blunt	Standard Pattern	8 ³ / ₄ in 222 mm
22-3504	4 Prong, Blunt	Standard Pattern	8 ³ / ₄ in 222 mm
22-3506	6 Prong, Blunt	Standard Pattern	8 ³ / ₄ in 222 mm
50-4220CO	2 Prong, Sharp	⁷ / ₁₆ x ¹¹ / ₁₆ in 11 x 17 mm	8 ³ / ₄ in 222 mm
50-4221CO	3 Prong, Sharp	¹¹ / ₁₆ x ¹¹ / ₁₆ in 11 x 17 mm	8 ³ / ₄ in 222 mm
504222CO	4 Prong, Sharp	¹⁵ / ₁₆ x ¹¹ / ₁₆ in 24 x 17 mm	8 ³ / ₄ in 222 mm
50-4223CO	6 Prong, Sharp	1 ¹ / ₂ x ¹¹ / ₁₆ in 17 x 38 mm	8 ³ / ₄ in 222 mm
50-4225CO	2 Prong, Blunt	⁷ / ₁₆ x ¹¹ / ₁₆ in 11 x 17 mm	8 ³ / ₄ in 222 mm
50-4226CO	3 Prong, Blunt	¹¹ / ₁₆ x ¹¹ / ₁₆ in 17 x 17 mm	8 ³ / ₄ in 222 mm
504227CO	4 Prong, Blunt	¹⁵ / ₁₆ x ¹¹ / ₁₆ in 24 x 17 mm	8 ³ / ₄ in 222 mm
50-4228CO	6 Prong, Blunt	1 ¹ / ₂ x ¹¹ / ₁₆ in 38 x 17 mm	8 ³ / ₄ in 222 mm



50-4226CO

Retractors (Nerve Root)

D'Errico Nerve Root Retractor

CODE	DESCRIPTION	BLADE WIDTH	LENGTH
20-1814	Bayonet	¼ in 6.0 mm	9 in 229 mm



Holsher Nerve Root Retractor

CODE	DESCRIPTION	BLADE WIDTH	LENGTH
50-1331	Nerve Root Retractor	⅝ in 7.0 mm	9¾ in 248 mm



Scoville Nerve Root Retractor

90° Angle

CODE	BLADE WIDTH	SHAFT LENGTH	HANDLE LENGTH
50-1291	⅝ in (8 mm)	4¼ in 108 mm	5 in 127 mm
50-1293	½ in (13 mm)	4¼ in 108 mm	5 in 127 mm



Retractors (Pyloric Stenosis)

Benson Pyloric Stenosis Spreader Retractor

CODE	DESCRIPTION	LENGTH
50-5115	Stenosis Spreader	6⅛ in 156 mm



Retractors (Renal)

Wylie Renal Retractor

CODE	DESCRIPTION	BLADE WIDTH
54-1795	Renal Retractor	1 x 4 in 25 x 102 mm
54-1797	Renal Retractor	1 x 7 in 25 x 178 mm



Retractors (Renal Sinus)

Gil-Vernet Renal Sinus Retractor

CODE	DESCRIPTION	BLADE WIDTH	LENGTH
5150-A	Renal Sinus Retractor	9.0 mm	11 ¼ in 286 mm
5150-B			11 ¼ in 286 mm
5150-C			11 ¼ in 286 mm
5150-D			11 ¼ in 286 mm



Retractors (Scalp)

Contour Scalp Retractor

CODE	DESCRIPTION	LENGTH
24-2670	3 x 4 Prongs, Blunt	5 ½ in 140 mm
24-2671	3 x 4 Prongs, Sharp	5 ½ in 140 mm

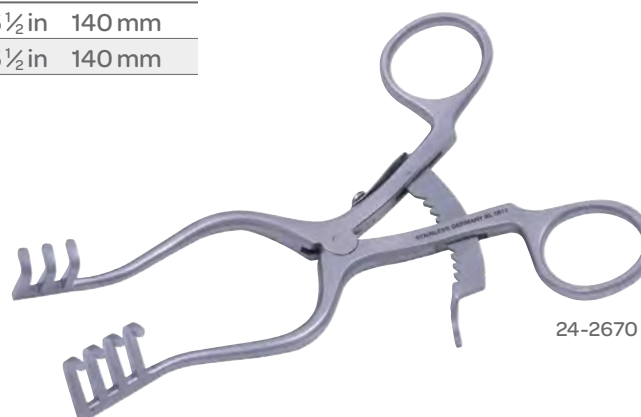

Retractors (Scalp)

Jansen Scalp Retractor

CODE	DESCRIPTION	LENGTH
24-1310	3 x 3 Prongs, Sharp	4 in 102 mm
24-1320	3 x 3 Prongs, Blunt	4 in 102 mm
24-1321	4 x 4 Prongs, Blunt	4 ³ / ₈ in 111 mm



24-1310

Retractors (Self-Retaining)

Adson 4 x 4 Retractor

4 x 4 Prongs, Sharp

CODE	DESCRIPTION	TOTAL OPENING	BLADE WIDTH	BLADE DEPTH	LENGTH
50-1180	Straight Arms, Straight Shaft	4 ¹ / ₂ in 114 mm	⁵ / ₈ in 16 mm	⁷ / ₈ in 22 mm	7 ¹ / ₂ in 191 mm
50-1182	Straight Arms, Straight Shaft	4 ¹ / ₂ in 114 mm	⁵ / ₈ in 16 mm	⁷ / ₈ in 22 mm	7 ¹ / ₂ in 191 mm
50-1181	Angled Arms, Angular Shaft	4 ¹ / ₂ in 114 mm	⁵ / ₈ in 16 mm	⁷ / ₈ in 22 mm	7 in 178 mm



50-1180

Adson Retractor

CODE	DESCRIPTION	ANGLE	PRONGS	TOTAL OPENING	LENGTH
50-1362	Sharp, Curved	65°	3 x 3	5 in 127 mm	9 ¹ / ₂ in 241 mm



Retractors (Self-Retaining)

Alm Self-Retaining Retractor

CODE	DESCRIPTION	LENGTH
24-1007	4 x 4 Prongs, Sharp	2 ¾ in 70 mm
24-1010	4 x 4 Prongs, Sharp	4 in 102 mm
24-1008	4 x 4 Prongs, Blunt	2 ¾ in 70 mm
24-1011	4 x 4 Prongs, Blunt	4 in 102 mm



24-1007

Alms Wound Retractor

CODE	DESCRIPTION	PRONG DEPTH	TOTAL OPENING	LENGTH
50-4265	Semi-Sharp Prongs	1/8 in 3.0 mm	2 in 51 mm	3 in 76 mm



Anderson-Adson Scalp Retractor

Angular Arms

CODE	DESCRIPTION	BLADE WIDTH	BLADE DEPTH	TOTAL OPENING	LENGTH
50-1186	4 x 4 Sharp Prongs	3/4 in 19 mm	5/8 in 16 mm	4 1/2 in 114 mm	7 1/2 in 191 mm



Beckman Adson Retractor

CODE	DESCRIPTION	PRONGS	TOTAL OPENING	BLADE DEPTH	LENGTH
50-1165	Sharp, Self-Retaining w/ Hinged Arms	4 x 4	5 1/2 in 140 mm	1 in 25 mm	12 in 305 mm



Retractors (Self-Retaining)

Beckman-Eaton Laminectomy Retractor

Self-Retaining with Hinged Arms

CODE	PRONGS	BLADE WIDTH		TOTAL OPENING		LENGTH	
50-1163	7x7	1¾ in	44 mm	5½ in	140 mm	12¾ in	324 mm



Beckman-Adson Laminectomy Retractor

Self-Retaining with Hinged Arms

CODE	DESCRIPTION	BLADE (W X D)		TOTAL OPENING		LENGTH	
50-1160	Blunt	1 x 1¼ in	25 x 32 mm	5 in	127 mm	12 in	305 mm
50-1161	Sharp	1 in	25 mm	5 in	127 mm	12 in	305 mm
50-1162	Blunt	1 x 1 in	25 x 25 mm	5½ in	140 mm	12 in	305 mm



Beckmann-Adson Laminectomy Retractor

Hinged Arms

CODE	DESCRIPTION	BLADE WIDTH		LENGTH	
24-3425	4 x 4 Prongs, Sharp	1 in	25 mm	12⅛ in	308 mm
24-3426	4 x 4 Prongs, Blunt	1 in	25 mm	12⅛ in	308 mm
24-3446	4 x 4 Prongs, Blunt	1¾ in	44 mm	12⅛ in	308 mm



Retractors (Self-Retaining)

Black 90° Dural Suction Retractor

CODE	TIP (W X D)	WORKING DISTANCE	HANDLE LENGTH
46-3012	$\frac{9}{32} \times \frac{1}{4}$ in 8.0 x 6.0 mm	4 $\frac{3}{4}$ in 120 mm	4 $\frac{5}{8}$ in 117 mm



Charnley Retractor Blades

CODE	DESCRIPTION	SIZE
24-2012	Short Blade	1 x 1½ in 25 x 38 mm
24-2004	Short Blade	1 x 2½ in 25 x 64 mm
24-2009	Short Blade	1 x 4 in 25 x 102 mm
24-2004A	Short Blade, Angled	1 x 2½ in 25 x 64 mm
24-2009A	Short Blade, Angled	1 x 4 in 25 x 102 mm
24-2020	Rounded Tip	1½ x 2½ in 38 x 64 mm
24-2020A	Angled Tip	1½ x 2½ in 38 x 64 mm
24-2011	Long Blade	1 x 1½ in 25 x 38 mm
24-2005	Long Blade	1 x 2½ in 25 x 64 mm
24-2010	Long Blade	1 x 4 in 25 x 102 mm
24-2019	Long Blade, Rounded Tip	1 x 2 in 25 x 51 mm
24-2019A	Long Blade, Angled Tip	1 x 2 in 25 x 51 mm
24-2005A	Long Blade, Angled	1 x 2½ in 25 x 64 mm
24-2010A	Long Blade, Angled	1 x 4 in 25 x 102 mm



24-2009

Retractors (Self-Retaining)

Charnley Initial Incision Retractor

CODE	DESCRIPTION
24-2000	Complete set
24-2000C	Chain
24-2000CW	Chain with Weight

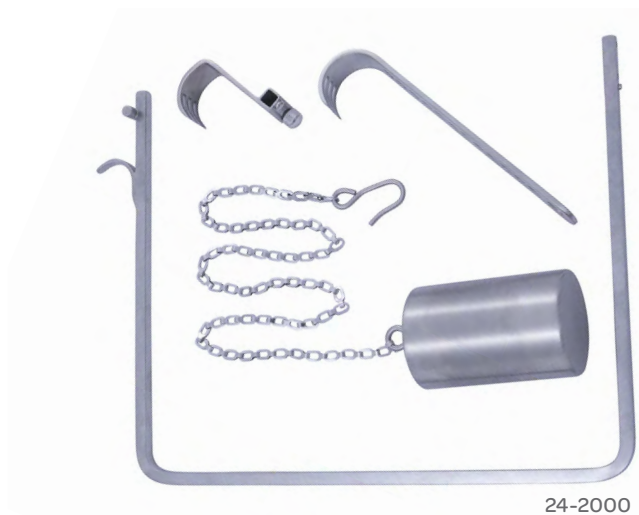

24-2000

Cone Scalp Retractor

With Hinged Arms

CODE	DESCRIPTION	LENGTH
50-1166	3 x 4 Prongs, Blunt	5 3/4 in 146 mm



Cone Laminectomy Retractor

Self-Retaining, Hinged Arms

CODE	DESCRIPTION	LENGTH
50-1167	3 x 4 Prongs, Sharp	6 3/8 in 162 mm
50-1168	3 x 4 Prongs, Sharp	8 in 203 mm



50-1167

Retractors (Self-Retaining)

Contour Scalp Retractor

Self-Retaining, with Blades Curved to Fit Contour of Skull

CODE	DESCRIPTION	BLADE (W X D)	TOTAL OPENING	LENGTH
50-1220	3 x 4 Prongs, Blunt	$\frac{5}{8}$ x $\frac{5}{8}$ in 16 x 16 mm	2 $\frac{1}{2}$ in 64 mm	5 $\frac{1}{2}$ in 140 mm



Gelpi Perineal Retractor

CODE	DESCRIPTION	TOTAL OPENING	LENGTH
50-1210	Self-Retaining	3 $\frac{3}{4}$ in 95 mm	7 $\frac{1}{4}$ in 184 mm



Gelpi Retractor

CODE	DESCRIPTION	LENGTH	WIDTH	CODE	DESCRIPTION	LENGTH	WIDTH
24-4013		3 $\frac{1}{2}$ in 89 mm		24-4017	Tips Bent 90°	6 $\frac{3}{4}$ in 171 mm	
24-4015		4 $\frac{1}{2}$ in 114 mm		24-4057	With Ball Stops	7 $\frac{1}{2}$ in 191 mm	
24-4018		6 $\frac{3}{4}$ in 121 mm					



Jansen Mastoid Retractor

Self-Retaining

CODE	DESCRIPTION	PRONG (W X D)	TOTAL OPENING	LENGTH
50-1227	3 x 3 Prongs, Blunt	$\frac{1}{16}$ x $\frac{3}{8}$ in (17 x 10 mm)	1 $\frac{3}{4}$ in 44 mm	4 in 102 mm



Retractors (Self-Retaining)

Jansen Scalp Retractor

Self-Retaining, Blunt

CODE	DESCRIPTION	PRONG (W X D)	BLADE WIDTH	BLADE DEPTH	TOTAL OPENING	LENGTH
50-1226	4 x 4 Prongs	$\frac{3}{4} \times \frac{3}{8}$ in 19 x 10 mm	$\frac{3}{4}$ in 19 mm	$\frac{3}{4}$ in 19 mm	3 in 76 mm	4 $\frac{5}{8}$ in 117 mm



Markham-Meyerding Hemilaminectomy Retractor

Self-Retaining

CODE	DESCRIPTION	BLADE WIDTH	BLADE DEPTH	TOTAL OPENING	TOTAL LENGTH
50-1205	Left	1 in 25 mm	2 in 51 mm	3 $\frac{3}{4}$ in 95 mm	7 in 178 mm
50-1206	Right	1 in 25 mm	2 in 51 mm	3 $\frac{3}{4}$ in 95 mm	7 in 178 mm



50-1205

Microvascular Modified Alm Retractor

Black Anodized

CODE	DESCRIPTION	LENGTH
80-1812	4 x 4 Prongs	3 in 76 mm
80-1813	12 x 12 Prongs	3 $\frac{3}{4}$ in 95 mm



80-1813

Miskimon Cerebellar Retractor

CODE	DESCRIPTION	BLADE (W X D)	LENGTH
50-1363	7 x 7 Prongs, Sharp	1 $\frac{1}{4}$ x 1 $\frac{3}{8}$ in (32 x 35 mm)	7 $\frac{1}{2}$ in 191 mm



Retractors (Self-Retaining)

Meyerding Laminectomy Retractor

CODE	DESCRIPTION	BLADE WIDTH	BLADE DEPTH	TOTAL OPENING	TOTAL OPENING
50-1191	Self-Retaining	1in 25 mm	2in 51mm	3¾in 95 mm	6½in 165 mm



Poppen-Gelpi Laminectomy Retractor

CODE	DESCRIPTION	TOTAL OPENING	LENGTH
50-1212	Self-Retaining	2½in 64 mm	5½in 140 mm



Tissue Retractors

Blunt

CODE	DESCRIPTION	PRONG (W X D)	TOTAL OPENING	LENGTH
50-1223	3 x 3 Prongs	½ x ⅝ in 13 x 16 mm	2½ in 64 mm	5¼ in 133 mm
50-1224	1 x 1 Prong	½ in 13 mm	2½ in 64 mm	5¼ in 133 mm



50-1223

Retractors (Self-Retaining)

Seletz-Gelpi Laminectomy Retractor

With Arms Bent at Right Angles

CODE	DESCRIPTION	ARM LENGTH,	TOTAL OPENING	LENGTH
50-1211	Self-Retaining	2 ⁹ / ₁₆ in 65 mm	3 ³ / ₄ in 95 mm	6 ¹ / ₄ in 159 mm



Snitman Endaural Retractor

Self-Retaining

CODE	DESCRIPTION	PRONG (W X D)	TOTAL OPENING	LENGTH
50-1236	3 x 3 Prongs, Sharp	9/16 x 3/8 in 14 x 10 mm	2 in 51 mm	4 ³ / ₁₆ in 106 mm



Weitlaner Retractor

CODE	DESCRIPTION	LENGTH
24-2210	2 x 3 Prongs, Sharp	4 ¹ / ₂ in 114 mm
24-2213	3 x 4 Prongs, Sharp	5 ¹ / ₂ in 140 mm
24-2216	3 x 4 Prongs, Sharp	6 ¹ / ₂ in 165 mm
24-2220	3 x 4 Prongs, Sharp	8 in 203 mm
24-2224	3 x 4 Prongs, Sharp	9 in 229 mm
24-2211	2 x 3 Prongs, Blunt	4 ¹ / ₂ in 114 mm
24-2214	3 x 4 Prongs, Blunt	5 ¹ / ₂ in 140 mm
24-2217	3 x 4 Prongs, Blunt	6 ¹ / ₂ in 165 mm
24-2221	3 x 4 Prongs, Blunt	8 in 203 mm
24-2225	3 x 4 Prongs, Blunt	9 in 229 mm

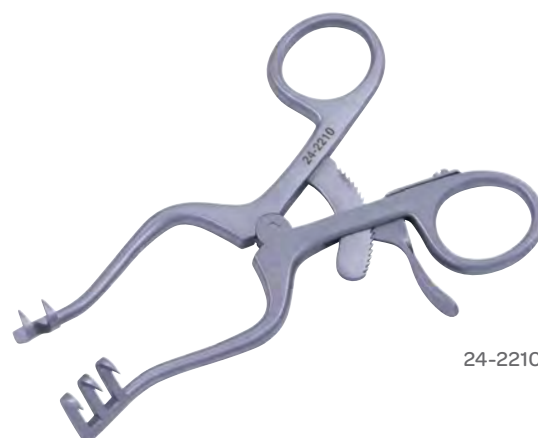

24-2210

Retractors (Self-Retaining)

Weitlaner Retractor

Self-Retaining Prongs

CODE	DESCRIPTION	TOTAL OPENING	LENGTH
50-5646	2 X 3 Prongs, Sharp	2¼ in 57 mm	4½ in 114 mm
50-1194	3 x 4 Prongs, Sharp	2¼ in 57 mm	5½ in 140 mm
50-1196	3 x 4 Prongs, Sharp	4 in 102 mm	6½ in 165 mm
50-1198	3 x 4 Prongs, Sharp	5 in 127 mm	7½ in 191 mm
50-1200	3 X 4 Prongs, Sharp	5¾ in 146 mm	9 in 229 mm
50-5646	2 X 3 Prongs, Blunt	2¼ in 57 mm	4½ in 114 mm
50-1195	3 x 4 Prongs, Blunt	2¼ in 57 mm	5½ in 140 mm
50-1197	3 x 4 Prongs, Blunt	4 in 102 mm	6½ in 165 mm
50-1199	3 x 4 Prongs, Blunt	5 in 127 mm	7½ in 191 mm
50-1201	3 X 4 Prongs, Blunt	5¾ in 146 mm	9 in 229mm

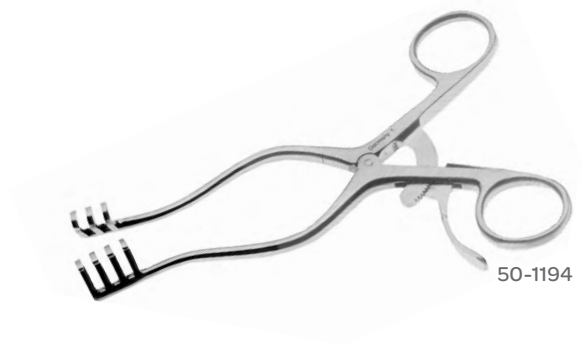

50-1194

Weitlaner-Beckmann Retractor

Hinged Arms

CODE	DESCRIPTION	LENGTH
24-3014	3 x 4 Prongs, Blunt	5½ in 140 mm
24-3017	3 x 4 Prongs, Blunt	6½ in 165 mm
24-3021	3 x 4 Prongs, Blunt	8½ in 216 mm
24-3024	3 x 4 Prongs, Blunt	9½ in 241 mm
24-3023	3 x 4 Prongs, Sharp	9½ in 241 mm

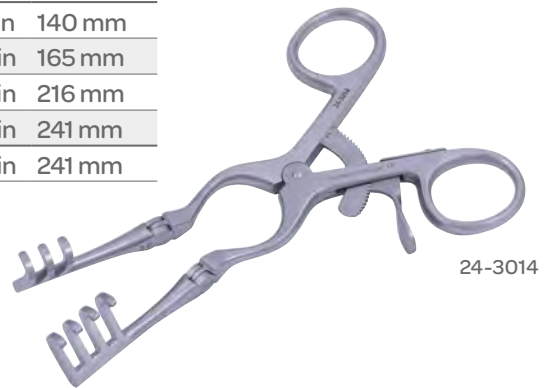

24-3014

Wiltse-Gelpi Retractor

Deep Blades

CODE	DESCRIPTION	LENGTH
24-4760	1x1 Prongs, Sharp	11 in 279 mm



Retractors (Spring)

Farr Spring Retractor

CODE	PRONG	LENGTH
24-0307	1 in 25 mm	5 ½ in 140 mm
24-0306	1 in 25 mm	9 in 229 mm

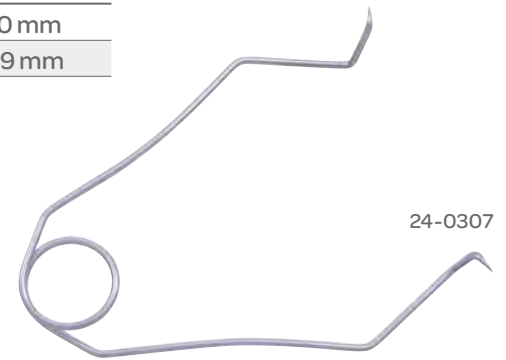

Spring Retractor

CODE	DESCRIPTION	BLADE LENGTH (W X D)	LENGTH
50-4350	1 Prong, Sharp	¾ in 10 mm	3 ½ in 79 mm
50-4351	3 Prong, Semi-Sharp	7/16 x 9/16 in 11 x 14 mm	3 ¼ in 83 mm

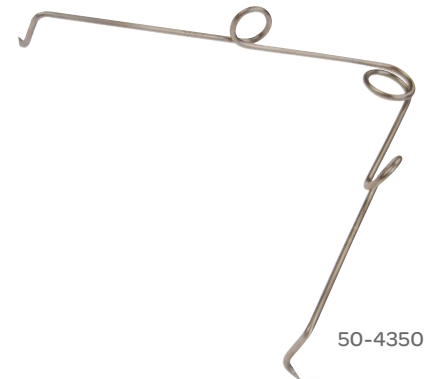

Spring Retractor

CODE	DESCRIPTION	LENGTH
24-0300	1x1 Prong, Sharp	2 ½ in 64 mm
24-0301	1x1 Prong, Sharp	3 ½ in 89 mm
24-0352	1x1 Prong, Sharp	4 ½ in 105 mm
24-0302	1x1 Prong, Sharp	4 ½ in 114 mm
24-0327	1x1 Prong, Sharp	
24-0303	3 x 3 Prongs, Blunt	3 ½ in 89 mm
24-0304	3 x 3 Prongs, Blunt	4 ½ in 114 mm

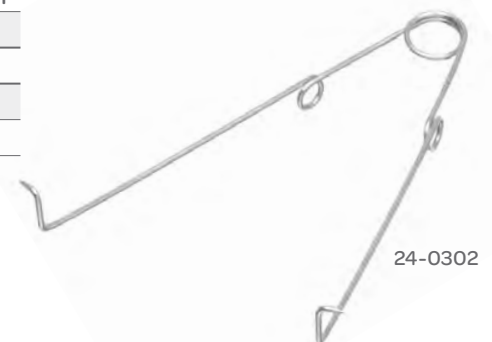

Retractors (Thyroid)

Mahorner Thyroid Retractor

CODE	DESCRIPTION	LENGTH
24-0888	7 Prong	10½ in 267 mm

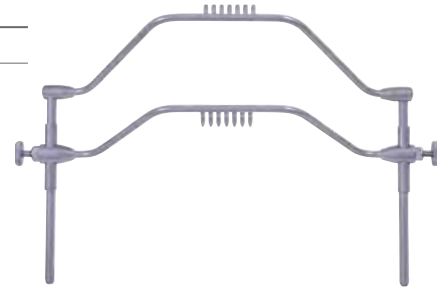

McBurney Thyroid Retractor

CODE	DESCRIPTION	LENGTH
20-1782	Fenestrated	7½ in 191 mm



Retractors (Tracheal)

News Tracheal Hook Retractor

CODE	DESCRIPTION	LENGTH
20-4015	1 Prong, Sharp	6 in 152 mm



Retractors (Vagotomy)

Weinberg Vagotomy Retractor

CODE	DESCRIPTION	DIMENSIONS	LENGTH
23-5917	Double-Ended	2 x 2½ in 51 x 38 mm	3½ in x 6¼ in 89 x 159 mm



Retractors (Vein)

Cushing Vein Retractor

CODE	WIDTH	LENGTH
20-1710	10 mm	8 in 203 mm
20-1712	12 mm	8 in 203 mm
20-1714	14 mm	8 in 203 mm
20-1718	18 mm	8 in 203 mm
20-1728	8.0 mm	9½ in 241 mm
20-1730	10 mm	9½ in 241 mm
20-1732	12 mm	9½ in 241 mm
20-1736	16 mm	9½ in 241 mm



20-1710

Rings

Laparotomy Ring

CODE	DIAMETER
01-1004	2 in 51 mm

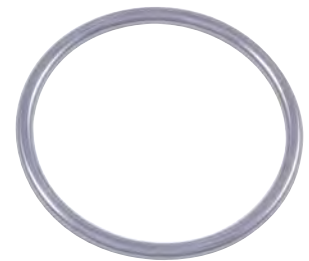

Ring Cutters

Ring Cutter

CODE	DESCRIPTION
43-4500	Finger Ring Cut Economy
43-4501	Finger Ring Cutter, Saw Blade Only for 43-4500
43-4600	Finger Ring Cutter with Plier Handle



43-4500

Rulers

Measuring Tape

CODE	DESCRIPTION
44-3515	Tape Measure in Inches and Centimeters Up to 150 cm/5 ft



44-3515

Ruler

CODE	DESCRIPTION	LENGTH
44-3715	Stainless Steel	6 in 152 mm
44-3720	Stainless Steel	8 in 203 mm
44-3730	Stainless Steel	11 3/4 in 298 mm



44-3715

Scissors (Abdominal)

Doyen Abdominal Scissors

CODE	DESCRIPTION	LENGTH
54-4080C	Straight	7 in 178 mm



Fergusson Abdominal Scissors

CODE	DESCRIPTION	LENGTH
54-4085C	Angled On Flat	7 1/4 in 184 mm



Scissors (Angled)

Wilmer Angled Scissors

CODE	DESCRIPTION	LENGTH
60-1850	Angled On Flat	4 in 102 mm



Scissors (Artery)

Coronary Artery Scissors

Angled, Flat Handle

CODE	DESCRIPTION	LENGTH
55-8601	25°	6¾ in 171 mm
55-8602	45°	6¾ in 171 mm
55-8603	60°	6¾ in 171 mm
55-8604	90°	6¾ in 171 mm
55-8605	120°	6¾ in 171 mm



55-8601

Coronary Artery Scissors

Angled, Flat Handle, Ball Tip

CODE	DESCRIPTION	LENGTH
55-8501	25°	6¾ in 171 mm
55-8504	90°	6¾ in 171 mm
55-8502	45°	6¾ in 171 mm
55-8503	60°	6¾ in 171 mm
55-8505	120°	6¾ in 171 mm



55-8501

Scissors (Artery)

Dietrich Coronary Artery Scissors

Angled

CODE	DESCRIPTION	BLADE LENGTH	BLADE WIDTH	LENGTH
54-8017	25°	½ in 13 mm	⅛ in 3.0 mm	7 in 178 mm
54-8018	45°	½ in 13 mm	⅛ in 3.0 mm	7 in 178 mm
54-8019	60°	½ in 13 mm	⅛ in 3.0 mm	7 in 178 mm
54-8021	90°	½ in 13 mm	⅛ in 3.0 mm	7 in 178 mm
54-8020	120°, with Stabilizer Bar	½ in 13 mm	⅛ in 3.0 mm	7 in 178 mm



54-8020

Scissors (Bandage)

Bandage Scissors

CODE	DESCRIPTION	LENGTH
40-5322	One Blade Serrated	9 in 229 mm



Lister Bandage Scissors

CODE	DESCRIPTION	LENGTH
40-2514	Standard Finger Rings	5½ in 140 mm
54-4012	Standard Finger Rings	5¾ in 146 mm
40-2518	Standard Finger Rings	7⅛ in 181 mm
54-4013	Standard Finger Rings	7¼ in 184 mm
40-2520	Standard Finger Rings	8 in 203 mm
54-4192	One Large Ring	7½ in 191 mm
40-5550	Large Finger Rings	8 in 203 mm



54-4013

Lister Serrated Bandage Scissors

Angled, One Blade Serrated, with Black Handles

CODE	LENGTH
86-2518	7 in 178 mm
86-4520	8 in 203 mm



86-2518

Scissors (Bandage)

Universal Bandage Scissors

Plastic Handle

CODE	DESCRIPTION	LENGTH
40-4718	Black	7 $\frac{1}{8}$ in 181 mm
40-4719	Red	7 $\frac{1}{8}$ in 181 mm
40-4720	Dark Blue	7 $\frac{1}{8}$ in 181 mm
40-4721	Green	7 $\frac{1}{8}$ in 181 mm
40-4722	Orange	7 $\frac{1}{8}$ in 181 mm
40-4723	Yellow	7 $\frac{1}{8}$ in 181 mm
40-4724	Burgundy	7 $\frac{1}{8}$ in 181 mm
40-4725	Pink	7 $\frac{1}{8}$ in 181 mm
40-4726	Purple	7 $\frac{1}{8}$ in 181 mm
40-4727	Neon Green	7 $\frac{1}{8}$ in 181 mm
40-4728	White	7 $\frac{1}{8}$ in 181 mm
40-4729	Light Blue	7 $\frac{1}{8}$ in 181 mm



40-4718

Scissors (Bandage & Plastic)

Bergmann Bandage Scissors

CODE	DESCRIPTION	LENGTH
40-3323	Heavy	9 $\frac{1}{2}$ in 241 mm



Esmarch Bandage Scissors

CODE	LENGTH
40-3120	8 in 203 mm



Scissors (Crown & Collar)

Crown & Collar Scissors

Straight

CODE	DESCRIPTION	LENGTH
14-2610	Smooth Blade	4 in 102 mm



Scissors (Delicate)

Fine Scissors

Sharp/Sharp

CODE	DESCRIPTION	LENGTH
54-1075	Straight	4 ½ in 114 mm
54-1076	Curved	4 ½ in 114 mm



54-1075

Kaye Scissors

One Blade Serrated, Tungsten Carbide Cutting Edges, Outer Edges Semi-Sharp

CODE	DESCRIPTION	LENGTH
32-690	Curved	4 ½ in 114 mm
32-697	Curved	7 in 178 mm

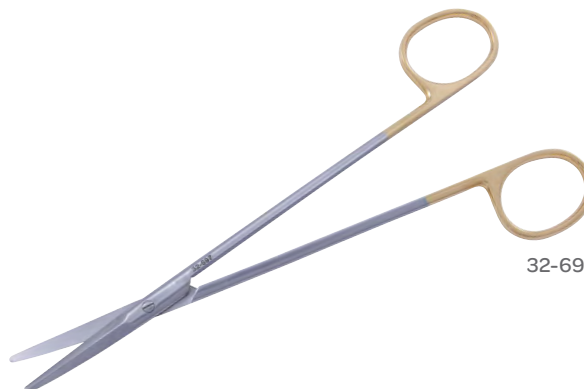

32-697

Scissors (Delicate)

Kaye Ceramic Coated Scissors

Razor Edge with Micro-Serrations On One Blade, Tungsten Carbide Cutting Edges, Black Ceramic Coating

CODE	DESCRIPTION	LENGTH
224.77.69	Curved	7½ in 191 mm



Par Scissors

Blunt, Tungsten Carbide Cutting Edges

CODE	DESCRIPTION	LENGTH
32-930	Curved	4¾ in 121 mm
32-931	Curved	5¾ in 146 mm



32-930

Par Razor Edge Scissors

Micro Serrations, Black Handle

CODE	DESCRIPTION	LENGTH
80-2180	Straight	4½ in 114 mm
80-2185	Curved	4½ in 114 mm



80-2180

Wagner Scissors

Straight, Fine Tips

CODE	DESCRIPTION	LENGTH
02-0612	Sharp/Sharp	4¾ in 121 mm
02-0632	Sharp/Blunt	4¾ in. 121 mm

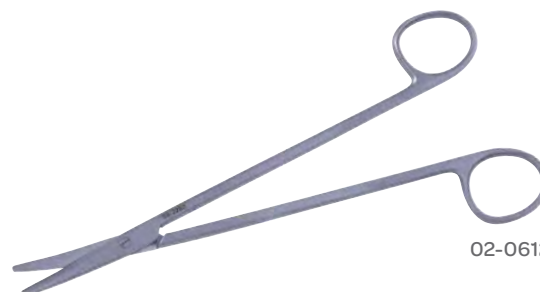

02-0612

Scissors (Dissecting)

Metzenbaum Dissecting Scissors

Regular Tips, Tungsten Carbide Cutting Edges

CODE	DESCRIPTION	LENGTH
32-720	Straight	5¾ in 146 mm
32-710	Curved	5¾ in 146 mm



32-720

Classic® Mayo Scissors

Round Blades

CODE	DESCRIPTION	LENGTH
34-4092	Straight	6¾ in 171 mm
34-4097	Curved	6¾ in 171 mm



34-4092

Cottle Micro-Serrated Scissors

One Blade Serrated, Gold Screw

CODE	DESCRIPTION	LENGTH
267.53.16	Angled	6¼ in 159 mm



Dandy Trigeminal Scissors

Angled Shaft, Curved Tips

CODE	DESCRIPTION	LENGTH
54-1041	Sharp	7¾ in 197 mm



Scissors (Dissecting)

Delicate Dissecting Scissors

CODE	DESCRIPTION	LENGTH
54-5566	Curved	5 in 127 mm



Delicate Scissors

CODE	DESCRIPTION	LENGTH
54-2515	Straight, Blunt/Blunt	4½ in 114 mm
54-5567	Curved with Dissecting End	4⅞ in 124 mm



54-2515

Demartel Scissors

Extra Delicate, Sharp Tips

CODE	DESCRIPTION	LENGTH
04-7018	Straight	6¾ in 171 mm



Dissecting Scissors

Extra Delicate, Sharp Tips

CODE	DESCRIPTION	LENGTH
02-5062	Straight, with Probe	4⅛ in 105 mm
02-5063	Curved, Ball Tip	4⅛ in 105 mm
02-5065	Angled, Ball Tip	4⅛ in 105 mm



02-5062

Scissors (Dissecting)

Dissecting Scissors, Serrated

One Blade Serrated

CODE	DESCRIPTION	LENGTH
85-2016	Straight	4 ³ / ₄ in 121 mm
85-2017	Curved	4 ³ / ₄ in 121 mm



85-2017

Fomon Micro-Serrated Scissors

One Blade Serrated, Gold Screw

CODE	DESCRIPTION	LENGTH
267.53.13	Angled	5 ¹ / ₂ in 140 mm



Gorney Ceramic Coated Scissors

Razor Edge with Micro-Serrations On One Blade, Tungsten Carbide Cutting Edges, Black Ceramic Coating

CODE	DESCRIPTION	LENGTH
224.73.69	Curved	7 ¹ / ₂ in 191 mm



Iris Ceramic Coated Scissors

One Blade Serrated, Tungsten Carbide Cutting Edges, Black Ceramic Coating

CODE	DESCRIPTION	LENGTH
222.20.61	Straight	4 ¹ / ₂ in 114 mm



Scissors (Dissecting)

Jameson Reynolds Ceramic Coated Scissors

One Blade with Micro-Serrations, Tungsten Carbide Cutting Edges, Black Ceramic Coating

CODE	DESCRIPTION	LENGTH
224.67.66	Curved	6 ¼ in 159 mm
224.67.68	Curved	7 in 176 mm



224.67.68

Jameson Reynolds Micro-Serrated Scissors

One Blade Serrated, Gold Screw

CODE	DESCRIPTION	LENGTH
204.67.12	Curved, Slim Pattern	4 ¾ in 121 mm
204.67.16	Curved	6 ¼ in 159 mm



204.67.12

Jameson Metzenbaum Tenotomy Scissors

One Blade Serrated, Gold Screw

CODE	DESCRIPTION	LENGTH
37-4033	Curved	6 in 152 mm
37-4031	Curved	8 in 203 mm
37-4027	Curved	9 in 229 mm



37-4027

Jameson Reynolds Razor Edge Scissors

One Blade with Micro-Serrations, Black Handle with Gold Screw

CODE	DESCRIPTION	LENGTH
214.67.12	Curved	4 ¾ in 121 mm
214.67.16	Curved	6 ¼ in 159 mm
214.68.18	Curved	7 ⅛ in 181 mm



214.67.16

Scissors (Dissecting)

Jorgenson Dissecting Scissors

CODE	DESCRIPTION	LENGTH
54-4151	Stronge Curve	8½ in 216 mm
54-4023	Strong Curve, Rounded Tips	9 in 229 mm



54-4023

Joseph Serrated Scissors

One Blade Serrated, with Black Handles

CODE	DESCRIPTION	LENGTH
86-5015	Straight	6 in 152 mm
86-5115	Curved	6 in 152 mm



86-5015

Joseph Razor Edge Scissors

One Blade with Micro-Serrations, Black Handle with Gold Screw

CODE	DESCRIPTION	LENGTH
214.50.15	Straight	5¾ in 146 mm
214.51.15	Curved	5¾ in 146 mm



214.50.15

Joseph Razor Edge Serrated Scissors

One Blade Serrated, Gold Screw

CODE	DESCRIPTION	LENGTH
204.51.15	Curved	5¾ in 146 mm



Scissors (Dissecting)

Knapp Dissecting Scissors

Rounded Blades

CODE	DESCRIPTION	LENGTH
02-4010	Straight	4 in 102 mm
02-4110	Curved	4 in 102 mm



02-4110

Lahey Scissors

Delicate Pattern, Rounded Blades

CODE	DESCRIPTION	LENGTH
54-5571	Curved	5¾ in 146 mm



Lincoln Scissors

Very Delicate, Sharp Tips, Rounded Blades

CODE	DESCRIPTION	LENGTH
55-2270	Straight	7 in 178 mm
55-2280	Curved	7 in 178 mm

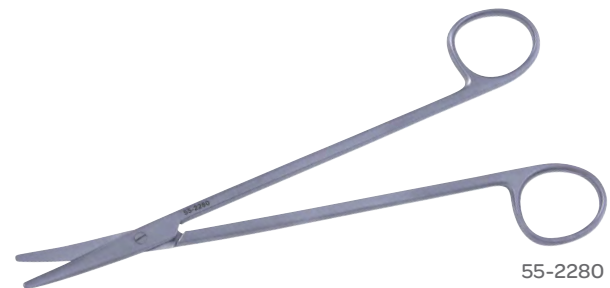

55-2280

MagnaFree® MRI Mayo Scissors

Non-Magnetic (Titanium) for Intraoperative MRI

CODE	DESCRIPTION	LENGTH
65-2416	Straight	6¾ in 171 mm



Scissors (Dissecting)

Mayo Carroll Scissors

Tungsten Carbide Cutting Edges

CODE	DESCRIPTION	LENGTH
32-860	Curved, Smooth Blades	9 in 229 mm



Mayo Dissecting Scissors, Curved

CODE	DESCRIPTION	LENGTH
03-5114	Beveled Blades	5 3/4 in 146 mm
03-5117	Beveled Blades	6 3/4 in 171 mm
03-5123	Beveled Blades	9 in 229 mm
03-5132	Beveled Blades	12 in 305 mm
03-5130	Beveled Blades	14 in 356 mm
03-5145	Beveled Blades	18 in 455 mm



03-5117

Mayo Dissecting Scissors, Curved

Fine Tungsten Carbide Cutting Edges

CODE	DESCRIPTION	LENGTH
32-652	Blade Serrated, Rounded Blades	6 in 152 mm
32-682	Blade Serrated, Rounded Blades	6 3/4 in 171 mm
32-801	Rounded Blades	5 1/2 in 140 mm
32-821	Rounded Blades	6 3/4 in 171 mm



32-652

Mayo Dissecting Scissors, Curved

Fine Tungsten Carbide Cutting Edges

CODE	DESCRIPTION	LENGTH
32-800	Beveled Blades	5 1/2 in 140 mm
32-820	Beveled Blades	6 3/4 in 171 mm
32-836	Beveled Blades	18 in 455 mm
32-820L	Beveled Blades, Left Handerd	6 3/4 in 171 mm



32-800

Scissors (Dissecting)

Mayo Dissecting Scissors, Straight

Fine Tungsten Carbide Cutting Edges

CODE	DESCRIPTION	LENGTH
32-811	Rounded Blades	5½ in 140 mm
32-831	Rounded Blades	6¾ in 171 mm
32-810	Beveled Blades	5½ in 140 mm
32-830	Beveled Blades	6¾ in 171 mm
32-830L	Beveled Blades, Left Hand Pattern	6¾ in 171 mm



32-831

Mayo Dissecting Scissors, Straight, Rounded Blade

Fine Tungsten Carbide Cutting Edges

CODE	DESCRIPTION	LENGTH
32-653	One Blade Serrated	5½ in 140 mm
32-683	One Blade Serrated	6¾ in 171 mm



32-653

Mayo Dissecting Scissors, Straight

Stainless Steel

CODE	DESCRIPTION	LENGTH
03-5014	Beveled Blades	5¾ in 146 mm
03-5017	Beveled Blades	6¾ in 171 mm
03-5023	Beveled Blades	9 in 229 mm
03-5040	Beveled Blades	16 in 406 mm
03-5045	Beveled Blades	18 in 488 mm



03-5017

Mayo Dissecting Scissors

Beveled Blades

CODE	DESCRIPTION	LENGTH
54-4090	Straight	6¾ in 171 mm



Scissors (Dissecting)

Mayo Classic® Dissecting Scissors

Stellite Edge Inserts, Rounded Edges

CODE	DESCRIPTION	LENGTH
36-5050	Straight	5½ in 140 mm
36-5051	Straight	6¾ in 171 mm
36-5052	Straight	9 in 229 mm
36-5060	Curved	5½ in 140 mm
36-5061	Curved	6¾ in 171 mm
36-5062	Curved	9 in 229 mm



36-5050

Mayo Dissecting Scissors

CODE	DESCRIPTION	LENGTH
54-4088	Straight, Round Blades	5¾ in 146 mm
54-4092	Straight, Round Blades	6¾ in 171 mm
54-4098	Straight, Beveled Blades	5½ in 140 mm
54-5535	Straight, Beveled Blades	9 in 229 mm
54-4097	Curved, Round Blades	6¾ in 171 mm
54-4095	Curved, Beveled Blades	6¾ in 171 mm
54-4099	Curved, Beveled Blades	5½ in 140 mm
54-4105	Curved, Beveled Blades	9 in 229 mm



54-4088

Mayo Harrington Serrated Scissors

One Blade Serrated, with Black Handles

CODE	DESCRIPTION	LENGTH
86-5323	Curved	9 in 229 mm



Scissors (Dissecting)

Mayo Ceramic Coated Scissors

Razor Edge with Micro-Serrations on One Blade, Beveled Edges Fine Tungsten Carbide Cutting Edges, Black Ceramic Coating

CODE	DESCRIPTION	LENGTH
223.50.67	Straight	6 ³ / ₄ in 171 mm
223.51.64	Curved	5 ¹ / ₂ in 140 mm
223.51.67	Curved	6 ³ / ₄ in 171 mm
223.51.73	Curved	9 in 229 mm



223.50.67

Mayo Serrated Scissors

One Blade Serrated

CODE	DESCRIPTION	LENGTH
85-2042	Straight	5 ¹ / ₂ in 140 mm
85-2043	Straight	6 ³ / ₄ in 171 mm
85-2044	Straight	9 in 229 mm
85-2046	Curved	6 ³ / ₄ in 171 mm



85-2044

Mayo Serrated Scissors

One Blade Serrated, Beveled Edges

CODE	DESCRIPTION	LENGTH
86-5014	Straight, w/Black Handles	5 ¹ / ₂ in 140 mm
86-5017	Straight, w/Black Handles	6 ³ / ₄ in 171 mm
86-5023	Straight, w/Black Handles	9 in 229 mm
86-5114	Curved, w/Black Handles	5 ¹ / ₂ in 140 mm
86-5117	Curved, w/Black Handles	6 ³ / ₄ in 171 mm
86-5123	Curved, w/Black Handles	9 in 229 mm



86-5023

Scissors (Dissecting)

Mayo Micro-Serration Razor Edge Scissors

One Blade with Micro-Serrations, Beveled Blades, Black Handle with Gold Screw

CODE	DESCRIPTION	LENGTH
213.50.17	Straight	6 ⁷ / ₈ in 175 mm
213.51.17	Curved	6 ³ / ₄ in 171 mm
213.51.23	Curved	9 in 229 mm



213.50.17

Mayo Micro-Serration Razor Edge Scissors

Razor Edge Blades, Black Handle

CODE	DESCRIPTION	LENGTH
80-5017	Straight	6 ³ / ₄ in 171 mm
80-5117	Curved	6 ³ / ₄ in 171 mm
80-5023	Straight	9 in 229 mm
80-5123	Curved	9 in 229 mm



80-5017

Mayo Razor Edge Serrated Scissors

One Blade Serrated, Gold Screw, Beveled Blades

CODE	DESCRIPTION	LENGTH
203.50.14	Straight	5 ¹ / ₂ in 140 mm
203.50.17	Straight	6 ³ / ₄ in 171 mm
203.51.17	Curved	6 ³ / ₄ in 171 mm
203.51.23	Curved	9 in 229 mm



203.50.14

Scissors (Dissecting)

Mayo-Harrington Dissecting Scissors

Slender Pattern

CODE	DESCRIPTION	LENGTH
03-5220	Straight	8 in 203 mm
03-5223	Straight	9 in 229 mm
03-5226	Straight	11½ in 292 mm



03-5220

Mayo-Harrington Dissecting Scissors

Slender Pattern

CODE	DESCRIPTION	LENGTH
03-5320	Curved	8 in 203 mm
03-5323	Curved	9 in 229 mm
03-5326	Curved	11½ in 292 mm
03-5330	Curved	14 in 356 mm



03-5320

Mayo-Harrington Scissors

Slender Pattern

CODE	DESCRIPTION	LENGTH
32-3592	Straight	14 in 356 mm
32-3593	Curved	14 in 356 mm



32-3592

Mayo-Stille Dissecting Scissors

Rounded Blades

CODE	DESCRIPTION	LENGTH
03-5615	Straight,	6 in 152 mm
03-5617	Straight	6¾ in 171 mm
03-5715	Curved	6 in 152 mm
03-5717	Curved	6¼ in 159 mm



03-5615

Scissors (Dissecting)

Mayo-Noble Dissecting Scissors

CODE	DESCRIPTION	LENGTH
03-5817	Straight, Beveled Blades	6 in 152 mm
54-4075	Straight, Beveled Blades	6 ³ / ₄ in 171 mm
54-4076	Curved, Beveled Blades	6 ¹ / ₄ in 159 mm



03-5817

Mayo-Stille Micro-Serration Razor Edge Scissors

One Blade with Micro-Serrations, Rounded Blades, Black Handle with Gold Screw

CODE	DESCRIPTION	LENGTH
213.56.15	Straight	5 ⁷ / ₈ in 149 mm
213.56.17	Straight	6 ³ / ₄ in 171 mm
213.57.17	Straight	6 ³ / ₄ in 171 mm



213.56.15

Mayo-Stille Ceramic Coated Scissors

Razor Edge with Micro-Serrations on One Blade, Tungsten Carbide Cutting Edges, Black Ceramic Coating

CODE	DESCRIPTION	LENGTH
223.56.67	Curved	6 ³ / ₄ in 171 mm
223.57.67	Straight	6 ³ / ₄ in 171 mm



223.57.67

Mayo-Stille Serrated Scissors

One Blade Serrated

CODE	DESCRIPTION	LENGTH
85-2049	Straight	6 ³ / ₄ in 171 mm



Scissors (Dissecting)

Metzenbaum Ceramic Coated Scissors

Razor Edge with Micro-Serrations on One Blade, Tungsten Carbide Cutting Edges, Black Ceramic Coating

CODE	DESCRIPTION	LENGTH
224.32.64	Straight	5½ in 140 mm
224.32.68	Straight	7⅛ in 181 mm
224.33.64	Curved	5⅝ in 143 mm
224.33.68	Curved	7 in 176 mm
224.33.70	Curved	8 in 203 mm
224.33.73	Curved	9 in 229 mm

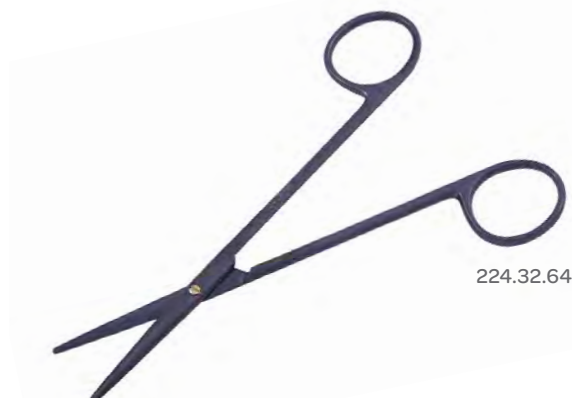

224.32.64

Metzenbaum Scissors

Rounded Blades

CODE	DESCRIPTION	LENGTH
04-3414	Straight, Delicate Pattern	5¾ in 146 mm
04-3514	Curved, Delicate Pattern	5¾ in 146 mm
04-3518	Curved, Delicate Pattern	7 in 178 mm
54-5573	Curved, Delicate Pattern	7 in 178 mm
04-3526	Curved, Delicate Pattern	10 in 254 mm
04-3214	Straight, Standard Pattern	5¾ in 146 mm
04-3218	Straight, Standard Pattern	7 in 178 mm
04-3314	Curved, Standard Pattern	5¾ in 146 mm
04-3318	Curved, Standard Pattern	7 in 178 mm
04-3320	Curved, Standard Pattern	10 in 203 mm



54-5573

Metzenbaum "Baby" Ceramic Coated Scissors

Micro-Serrations on One Blade, Curved

CODE	DESCRIPTION	LENGTH
224.33.61	Razor Edge, Tungsten Carbide Cutting Edges, Black Ceramic Coating	4½ in 114 mm
214.33.11	Delicate, Black Handle with Gold Screw	4½ in 114 mm



214.33.11

Scissors (Dissecting)

Metzenbaum "Slim" Micro-Serrations Razor Edge Scissors

Slender Pattern, One Blade with Micro-Serrations, Black Handle with Gold Screw

CODE	DESCRIPTION	LENGTH
214.34.14	Straight	5½ in 140 mm
214.35.14	Curved	5¾ in 146 mm
214.35.18	Curved	7 in 176 mm
214.35.23	Curved	9 in 229 mm



214.35.18

Metzenbaum "Baby" Serrated Scissors

One Blade Serrated

CODE	DESCRIPTION	LENGTH
85-3005	Curved	4½ in 114 mm



Metzenbaum Classic Plus® Dissecting Scissors

Stellite Edge Inserts

CODE	DESCRIPTION	LENGTH
36-5010	Straight	5¾ in 146 mm
36-5011	Straight	7 in 178 mm
36-5015	Curved	5¾ in 146 mm
36-5016	Curved	7 in 178 mm
36-5017	Curved	9 in 229 mm



36-5010

Scissors (Dissecting)

Metzenbaum Classic Plus® Dissecting Scissors

Delicate Stellite Edge Inserts

CODE	DESCRIPTION	LENGTH	
36-5020	Straight, Sharp Tips	5¾ in	146 mm
36-5022	Straight, Sharp Tips	7 in	178 mm
36-5025	Straight, Blunt Tips	9 in	229 mm
36-5030	Curved, Sharp Tips	5¾ in	146 mm
36-5031	Curved, Blunt Tips	5¾ in	146 mm
36-5032	Curved, Sharp Tips	7 in	178 mm
36-5033	Curved, Blunt Tips	7 in	178 mm
36-5034	Curved, Sharp Tips	9 in	229 mm
36-5035	Curved, Blunt Tips	9 in	229 mm



36-5020

Metzenbaum Dissecting Scissors

Regular Tips, Tungsten Carbide Cutting Edges

CODE	DESCRIPTION	LENGTH	
32-720	Straight	5¾ in	146 mm
32-760	Straight	7 in	178 mm
32-795	Straight	9 in	229 mm
32-710	Curved	5¾ in	146 mm
32-750	Curved	7 in	178 mm
32-790	Curved	9 in	229 mm
32-793	Curved	10 in	254 mm
32-750L	Curved, Left Handed	7 in	178 mm
32-790L	Curved, Left Handed	9 in	229 mm



32-790

Metzenbaum Dissecting Scissors, Curved

Tungsten Carbide Cutting Edges

CODE	DESCRIPTION	LENGTH	
32-678	One Blade Serrated, Delicate Tips	5¾ in	146 mm
32-651	One Blade Serrated, Delicate Tips	7⅙ in	179 mm
32-681	One Blade Serrated, Delicate Tips	9 in	229 mm
32-679	One Blade Serrated, Regular Tips	5¾ in	146 mm
32-677	One Blade Serrated, Regular Tips	7 in	178 mm
32-699	One Blade Serrated, Regular Tips	9 in	229 mm
32-712	Sharp/Sharp Tips	5¾ in	146 mm
32-752	Sharp/Sharp Tips	7 in	178 mm
32-711	Delicate Tips, Left Handed	5¾ in	146 mm
32-751	Delicate Tips	7 in	178 mm
32-791	Delicate Tips	9 in	229 mm

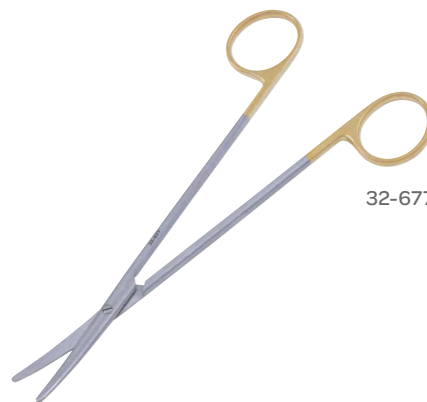

32-677

Scissors (Dissecting)

Metzenbaum Dissecting Scissors

Rounded Blades

CODE	DESCRIPTION	LENGTH	
54-1026	Straight	7 in	178 mm
54-1021	Curved	5 $\frac{3}{4}$ in	146 mm
54-1023	Curved	5 in	127 mm
54-1027	Curved	7 in	178 mm
54-1030	Curved	8 in	203 mm
54-1034	Curved	9 in	229 mm
54-1037	Curved	10 in	254 mm



54-1026

Metzenbaum Scissors

CODE	DESCRIPTION	LENGTH	
32-3594	Curved	12 $\frac{1}{4}$ in	311 mm
32-3595	Curved	13 $\frac{7}{8}$ in	355 mm
32-3596	Curved, Micro-Serrations	13 $\frac{7}{8}$ in	355 mm



32-3594

Metzenbaum Scissors

Delicate Pattern, Rounded Blades

CODE	DESCRIPTION	LENGTH	
04-3418	Straight	7 in	178 mm
04-3423	Straight	9 in	229 mm
04-3518	Curved	7 $\frac{1}{4}$ in	184 mm
04-3520	Curved	8 in	203 mm
04-3523	Curved	9 in	229 mm



04-3418

Scissors (Dissecting)

Metzenbaum Serrated Scissors

One Blade Serrated

CODE	DESCRIPTION	LENGTH	
85-2057	Curved	5 ³ / ₄ in	146 mm
85-2062	Curved	8 in	203 mm
85-2060	Curved	9 in	229 mm



85-2060

Metzenbaum Serrated Scissors

Delicate, One Blade Serrated

CODE	DESCRIPTION	LENGTH	
85-2067	Straight	7 ¹ / ₈ in	181 mm
85-2070	Curved	5 ³ / ₄ in	146 mm
85-2071	Curved	9 in	229 mm



85-2071

Metzenbaum Serrated Scissors

One Blade Serrated, with Black Handles

CODE	DESCRIPTION	LENGTH	
86-3214	Straight	5 ³ / ₄ in	146 mm
86-3223	Straight	9 in	229 mm
86-3318	Curved	7 in	178 mm
86-3323	Curved	9 in	229 mm



86-3214

Metzenbaum Serrated Scissors

One Blade Serrated with Black Handles

CODE	DESCRIPTION	LENGTH	
86-3218	Straight	7 in	178 mm
86-3211	Curved	4 ¹ / ₂ in	114 mm
86-3314	Curved	5 ³ / ₄ in	146 mm
86-3320	Curved	8 in	203 mm
86-3514	Curved, Slim Pattern	5 ³ / ₄ in	146 mm
86-3518	Curved, Slim Pattern	8 in	203 mm



86-3211

Scissors (Dissecting)

Metzenbaum Slim Ceramic Coated Scissors

Razor Edge with Micro-Serrations On One Blade, Tungsten Carbide Cutting Edges, Black Ceramic Coating

CODE	DESCRIPTION	LENGTH	
224.35.64	Curved	5 ³ / ₄ in	146 mm
224.35.68	Curved	7 in	178 mm
224.35.73	Curved	9 in	229 mm



224.35.68

Metzenbaum Micro-Serrated Razor Edge Scissors

Razor Edge Micro-Serration Blades, Black Handle

CODE	DESCRIPTION	LENGTH	
80-3305	Straight	4 ¹ / ₂ in	114 mm
80-3514	Curved, Delicate Pattern	5 ³ / ₄ in	146 mm
80-3518	Curved, Delicate Pattern	7 in	178 mm
80-3520	Curved, Delicate Pattern	8 in	203 mm
80-3523	Curved, Delicate Pattern	9 in	229 mm
80-3306	Curved	4 ¹ / ₂ in	114 mm
80-3314	Curved	5 ³ / ₄ in	146 mm
80-3318	Curved	7 ¹ / ₈ in	181 mm
80-3320	Curved	8 in	203 mm
80-3323	Curved	9 in	229 mm



80-3306



80-3318

Metzenbaum Micro-Serrated Razor Edge Scissors

Black Handle with Gold Screw

CODE	DESCRIPTION	LENGTH	
214.32.14	Straight	5 ¹ / ₂ in	140 mm
214.32.18	Straight	7 ¹ / ₈ in	181 mm
214.33.14	Curved	5 ¹ / ₂ in	140 mm
214.33.18	Curved	7 ¹ / ₈ in	181 mm
214.33.20	Curved	8 in	203 mm



214.32.14

Scissors (Dissecting)

Metzenbaum Micro-Serrated Scissors

One Blade Serrated, Gold Screw

CODE	DESCRIPTION	LENGTH
204.33.11	Curved, Baby Pattern	4½ in 114 mm



Metzenbaum Micro-Serrated Slim Scissors

One Blade Serrated, Gold Screw, Slim Pattern

CODE	DESCRIPTION	LENGTH
204.35.18	Curved	7⅛ in 181 mm
204.35.23	Curved	9 in 229 mm



204.35.18

Micro Dissecting Scissors

Curved, Flat Handle 8.0 mm Diameter

CODE	DESCRIPTION	LENGTH
78-0330	20 mm Blades	4½ in 114 mm
78-0345	Micro Pattern, 19 mm Serrated Blade	5¾ in 146 mm



78-0345

Micro Dissecting Scissors

Flat Handle 8.0 mm Diameter

CODE	DESCRIPTION	LENGTH
78-0355	Straight, 15 mm Blades	5½ in 140 mm
78-0350	Curved, 10 mm Serrated Blades	5½ in 140 mm



78-0355

Scissors (Dissecting)

Micro Scissors

Flat Handle 8.0 mm Diameter, 14.0 mm Blades

CODE	DESCRIPTION	LENGTH
78-0365	Straight	6 in 152 mm

Mixer Operating Scissors

Blunt

CODE	DESCRIPTION	LENGTH
54-1010	Straight	6 in 152 mm



Nelson Classic Plus® Scissors

Stellite Edge Inserts

CODE	DESCRIPTION	LENGTH
36-5070	Curved, Regular Tips	11 in 279 mm
36-5071	Curved, Delicate Tips	11 in 279 mm



36-5070

Nelson Metzenbaum Dissecting Scissors

Standard Pattern, Rounded Blades

CODE	DESCRIPTION	LENGTH
04-3223	Straight	9 in 229 mm
04-3226	Straight	10 ¼ in 260 mm
04-3230	Straight	11 ¾ in 398 mm
04-3232	Straight	14 in 356 mm
04-3245	Straight	18 in 458 mm
04-3323	Curved	9 in 229 mm
04-3326	Curved	10 ¼ in 260 mm
04-3330	Curved	11 ¾ in 298 mm
04-3338	Curved	12 in 305 mm
04-3332	Curved	14 in 356 mm
04-3340	Curved	16 in 406 mm
04-3345	Curved	18 in 458 mm



04-3223

Scissors (Dissecting)

Nelson Metzenbaum Scissors

Tungsten Carbide Cutting Edges

CODE	DESCRIPTION	LENGTH
32-794	Straight, Regular Tips	12 in 305 mm
32-798	Straight, Regular Tips	14 in 356 mm
32-799	Curved, Regular Tips	14 in 356 mm
32-880	Curved, Regular Tips	11 in 279 mm
32-882	Curved, Regular Tips	12 in 305 mm
32-899	Curved, Regular Tips	12 in 305 mm
32-999	Curved, Regular Tips	14 in 356 mm



32-794

Nelson Metzenbaum Micro-Serrated Razor Edge Scissors

One Blade with Micro-Serrations, Black Handle with Gold Screw

CODE	DESCRIPTION	LENGTH
214.33.23	Curved	9 in 229 mm
214.33.30	Curved	11 in 279 mm
214.33.26	Curved	11 ¼ in 286 mm



214.33.23

Nelson Metzenbaum Micro-Serrated Scissors

One Blade Serrated, Gold Screw

CODE	DESCRIPTION	LENGTH
204.32.30	Straight	11 ¾ in 298 mm



Nelson Scissors

Rounded Blades

CODE	DESCRIPTION	LENGTH
54-8025	Straight	9 in 229 mm



Scissors (Dissecting)

Ragnell Kilner Micro-Serrated Razor Edge Scissors

One Blade with Micro-Serrations, Black Handle with Gold Screw

CODE	DESCRIPTION	LENGTH
214.13.15	Curved	6 in 152 mm



Razor Edge Joseph Scissors

Micro-Serrated Blades, Black Handle

CODE	DESCRIPTION	LENGTH
80-5115	Curved	5 5/8 in 143 mm



Razor Freeman-Gorney Scissors

Razor Edge Micro-Serrated Blades, Black Handle

CODE	DESCRIPTION	LENGTH
80-6066	Curved	7 1/4 in 184 mm



Reynolds Dissecting Scissors

Delicate Pattern, Tenotomy Tips

CODE	DESCRIPTION	LENGTH
04-6712	Curved	5 in 127 mm
04-6714	Curved	5 5/8 in 143 mm
04-6716	Curved	6 1/4 in 159 mm
04-6718	Curved	7 1/8 in 181 mm
04-6718L	Curved, Left Handed Pattern	7 1/8 in 181 mm



04-6718

Micro-Serrated Dissecting Scissors

One Blade Serrated, Gold Screw

CODE	DESCRIPTION	LENGTH
202.41.12	Curved	4 3/4 in 121 mm



Scissors (Dissecting)

Vannas Dissecting Scissors

13 mm Blades, Round Handle 8.0 mm Diameter

CODE	DESCRIPTION	LENGTH	
78-0320	Straight	6 in	152 mm
78-0310	Curved	6 in	152 mm

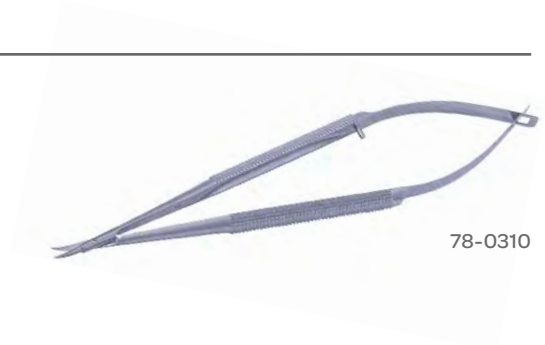

78-0310

Scissors (Dural)

Frazier Dural Scissors

CODE	DESCRIPTION	LENGTH	
54-1055	Angled	6 ³ / ₄ in	171 mm



Scissors (Enucleation)

Enucleation Scissors

Heavy Pattern

CODE	DESCRIPTION	LENGTH	
60-1750	Medium Curve	5 ¹ / ₂ in	140 mm
60-1751	Strong Curve	5 ¹ / ₂ in	140 mm
60-1749	Slight Curve	5 ¹ / ₂ in	140 mm



60-1750

Scissors (Episiotomy)

Braun Episiotomy Scissors

One Guarded Blade

CODE	DESCRIPTION	LENGTH	
54-5579	Angled	8½ in	216 mm



Roberts Episiotomy Scissors

CODE	DESCRIPTION	LENGTH	
54-5526	Serrated Blade	5½ in	140 mm



Scissors

Scissors

Straight, Serrated Jaws, Titanium

CODE	DESCRIPTION	LENGTH	
80-6008	Fine Tip	6 in	152 mm
80-6009	Regular Tip	6 in	152 mm



Scissors (Eye)

Eye Scissors

Standard Pattern

CODE	DESCRIPTION	LENGTH	
60-1847	Straight	4½ in	105 mm
60-1848	Curved	4½ in	105 mm



Scissors (Ganglion)

Adson Ganglion Scissors

Sharp

CODE	DESCRIPTION	LENGTH
54-1005	Straight	6 ¼ in 159 mm
54-1006	Curved	6 ¼ in 159 mm



54-1005

Adson Kelly Ganglion Scissors

Sharp Outer Edges

CODE	DESCRIPTION	LENGTH
04-5516	Curved	6 ¼ in 159 mm



Scissors (Gynecology)

Zep Scissors

Tungsten Carbide Cutting Edges

CODE	DESCRIPTION	LENGTH
32-889	Curved	9 in 229 mm
32-892	Curved	10 ½ in 267 mm
32-895	Curved	12 in 305 mm
32-890	Full Curve	9 in 229 mm
32-893	Full Curve	10 ½ in 267 mm
32-896	Full Curve	12 in 305 mm
32-898	Full Curve	14 in 356 mm
32-888	Slight Curve	9 in 229 mm
32-891	Slight Curve	10 ½ in 267 mm
32-894	Slight Curve	12 in 305 mm



32-898

Scissors (Iris)

Iris Scissors

CODE	DESCRIPTION	LENGTH
32-675	Curved, One Blade Serrated, Sharp Tips, Tungsten Carbide Cutting Edges	4 ½ in 114 mm
32-676	Straight, One Blade Serrated, Sharp Tips, Tungsten Carbide Cutting Edges	4 ½ in 114 mm
32-705	Curved, Sharp Tips, Tungsten Carbide Cutting Edges	4 ½ in 114 mm
32-706	Straight, Sharp Tips, Tungsten Carbide Cutting Edges	4 ½ in 114 mm
60-1829	Straight, Standard Pattern	
60-1830	Curved, Standard Pattern	4 in 102 mm
02-2009	Straight, Standard Pattern	3 ½ in 89 mm
02-2010	Straight, Standard Pattern	4 ⅛ in 105 mm
02-2011	Straight, Standard Pattern	4 ½ in 114 mm
02-2012	Straight, Standard Pattern	5 in 127 mm
02-2109	Curved, Standard Pattern	3 ½ in 89 mm
02-2110	Curved, Standard Pattern	4 ⅛ in 105 mm
02-2111	Curved, Standard Pattern	4 ½ in 114 mm
02-2112	Curved, Standard Pattern	5 in 127 mm
60-1823	Straight, Short Blades, Sharp Tips, Flat Shanks, Large Ribbon Ring Handles	4 in 102 mm
60-1824	Curved, Short Blades, Sharp Tips, Flat Shanks, Large Ribbon Ring Handles	4 in 102 mm
60-1826	Curved, Flat Shanks, Large Ribbon Ring Handles	4 ⅛ in 105 mm
60-1827	Straight, Delicate Blades, Sharp/Sharp, Large Ring Handles	4 in 102 mm
60-1828	Curved, Delicate Blades, Sharp/Sharp, Large Ring Handles	4 in 102 mm
60-1843	Straight, Blunt, Flat Shanks, Large Ribbon Ring Handles	4 in 102 mm
60-1845	Straight, Blunt, Flat Shanks, Large Ribbon Ring Handles	4 in 102 mm
60-1844	Curved, Blunt, Flat Shanks, Large Ribbon Ring Handles	4 in 102 mm
60-1846	Curved, Blunt, Flat Shanks, Large Ribbon Ring Handles	4 in 102 mm



32-705

Scissors (Iris)

Iris Classic® Scissors

Sharp/Sharp

CODE	DESCRIPTION	LENGTH
34-6500	Straight	4 ³ / ₈ in 111 mm
34-6503	Curved	4 ³ / ₈ in 111 mm



34-6500

Iris Classic Plus® Scissors

Sharp/Sharp, Tungsten Carbide Cutting Edges

CODE	DESCRIPTION	LENGTH
36-5000	Straight	4 ¹ / ₂ in 114 mm
36-5001	Curved	4 ¹ / ₂ in 114 mm



36-5000

Iris Ceramic Coated Scissors

One Blade Serrated, Tungsten Carbide Cutting Edges, Black Ceramic Coating

CODE	DESCRIPTION	LENGTH
222.21.61	Curved	4 ¹ / ₂ in 114 mm



Tip

Scissors (Iris)

Iris Serrated Scissors

One Blade Serrated

CODE	DESCRIPTION	LENGTH
85-2010	Straight	4 ¹ / ₈ in 105 mm
85-2013	Straight	4 ¹ / ₂ in 114 mm
85-2015	Curved	4 ¹ / ₂ in 114 mm
86-2011	Straight with Black Handles	4 ¹ / ₂ in 114 mm
86-2111	Curved with Black Handles	4 ¹ / ₂ in 114 mm



85-2010

Iris Micro-Serrated Razor Edge Scissors

One Blade, Black Handle with Gold Screw

CODE	DESCRIPTION	LENGTH
212.20.11	Straight	4 ¹ / ₂ in 114 mm



Iris Micro-Serrated Scissors

One Blade Serrated, Gold Screw

CODE	DESCRIPTION	LENGTH
202.20.10	Straight	4 ¹ / ₂ in 114 mm
202.21.10	Curved	4 ¹ / ₈ in 105 mm



202.20.10

Dissecting Scissors

Fine Pattern

CODE	DESCRIPTION	LENGTH
02-2042	Straight, Sharp/Sharp	4 ³ / ₄ in 121 mm
02-2043	Straight, Blunt/Blunt	4 ³ / ₄ in 121 mm
02-2142	Curved, Sharp/Sharp	4 ³ / ₄ in 121 mm



02-2042

Scissors (Iris)

Knapp Scissors

Rounded Blades, Blunt Tips

CODE	DESCRIPTION	LENGTH
60-1865	Straight, Standard Pattern	4 1/8 in 105 mm
60-1866	Curved, Standard Pattern	4 1/8 in 105 mm



60-1865

Knapp Iris Scissors

CODE	DESCRIPTION	LENGTH
54-6524	Straight, Sharp/Blunt	4 in 102 mm
54-6525	Curved, Sharp/Blunt	4 in 102 mm
54-6526	Straight, Blunt/Blunt	4 in 102 mm
54-6527	Curved, Blunt/Blunt	4 in 102 mm



54-6524

Scissors (Micro)

Double Action Micro Scissors

CODE	DESCRIPTION	LENGTH
55-8705	Curved Blades	7 1/4 in 184 mm



Jabaley Micro-Serrated Razor Edge Scissors

Razor Edge, Micro-Serrations, Black Handle

CODE	DESCRIPTION	LENGTH
80-2095	Straight	5 in 127 mm
80-2096	Curved	5 in 127 mm



80-2095

Scissors (Micro)

Jacobson Micro Scissors

Flat Handle

CODE	DESCRIPTION	LENGTH
55-8088	Angled, Sharp Tips	6 ³ / ₄ in 171 mm
55-8089	Angled, Dull Tips	6 ³ / ₄ in 171 mm
55-8710	25°, Angled On Flat	7 in 178 mm
55-8711	45°, Angled On Flat	7 in 178 mm
55-8712	60°, Angled On Flat	7 in 178 mm



55-8710

Micro Adventitia Scissors

15 mm Blades, Round Handle

CODE	DESCRIPTION	HANDLE DIAMETER	LENGTH
78-0510	Straight	8.0 mm	7 in 178 mm
78-0515	Curved	10 mm	7 in 178 mm



78-0510

Micro Dissecting Scissors

Vannas Type Cutting Blades

CODE	DESCRIPTION	BLADES	HANDLE	LENGTH
05-1230	Straight	5.0 mm	Flat	5 in 127 mm
05-1220	Straight	10 mm	Flat	5 in 127 mm
05-1221	Curved	10 mm	Flat	5 in 127 mm
05-1231	Curved	5.0 mm	Wide	5 in 127 mm



05-1230

Micro Scissors

CODE	DESCRIPTION	LENGTH
80-2005	Straight Tip	5 ¹ / ₂ in 140 mm
80-2015	Straight Tip	7 in 178 mm
80-2006	Curved Tip	5 ¹ / ₂ in 140 mm
80-2016	Curved Tip	7 in 178 mm



80-2006

Scissors (Micro)

Castroviejo Micro Scissors

Angled, Sharp Delicate Blades, Round Handle

CODE	DESCRIPTION	LENGTH
55-8049	25°	4 ½ in 114 mm
55-8050	45°	4 ½ in 114 mm
55-8051	60°	4 ½ in 114 mm
55-8053	125°	4 ½ in 114 mm

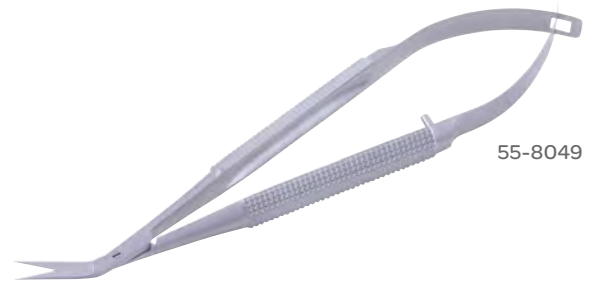

Scissors (Micro)

Micro Dissecting Scissors

CODE	DESCRIPTION	LENGTH
78-0306	Curved Blade, 8.0 mm	4 ¾ in 121 mm



Scissors (Moleskin)

Moleskin Scissors

Sharp/Blunt, One Blade Serrated

CODE	DESCRIPTION	LENGTH
04-1350	Straight	7 ½ in 191 mm



Scissors (Neuro)

Malis® Neurosurgical Scissors

CODE	DESCRIPTION	LENGTH
54-1015	Curved, Semi-Sharp Blades	7 in 178 mm



Malis® Scissors

Titanium

CODE	DESCRIPTION	WORKING DISTANCE	LENGTH
80-1520	Straight, Fine		6 3/4 in 171 mm
80-1521	Straight, Curved Fine		6 3/4 in 171 mm
80-1522	Straight, Bayonet, Regular	3 3/4 in 95 mm	9 1/2 in 241 mm
80-1523	Straight, Bayonet, Fine	3 3/4 in 95 mm	9 1/2 in 241 mm
80-1524	Curved Up, Bayonet, Regular	3 3/4 in 95 mm	9 1/2 in 241 mm
80-1525	Curved Up, Bayonet, Fine	3 3/4 in 95 mm	9 1/2 in 241 mm
80-1526	Curved Down, Bayonet, Regular	3 3/4 in 95 mm	9 1/2 in 241 mm

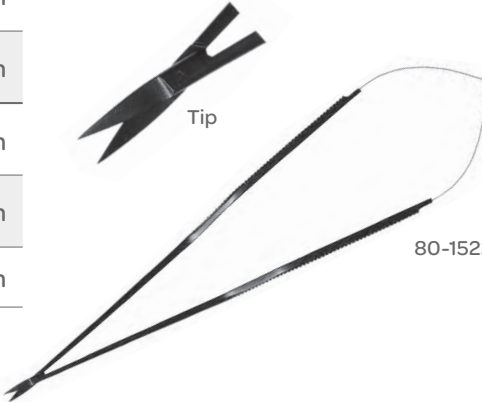

Malis® Scissors

Titanium

CODE	TIP	WORKING DISTANCE	LENGTH
80-1720	Straight		7 in 178 mm
80-1722	Straight, Bayonet	3 1/2 in 89 mm	8 1/2 in 216 mm
80-1744	Straight, Bayonet	3 1/2 in 89 mm	9 1/2 in 241 mm
80-1721	Curved		7 in 178 mm
80-1723	Curved, Bayonet	3 1/2 in 89 mm	8 1/2 in 216 mm
80-1745	Curved Up, Bayonet	3 1/2 in 89 mm	9 1/2 in 241 mm

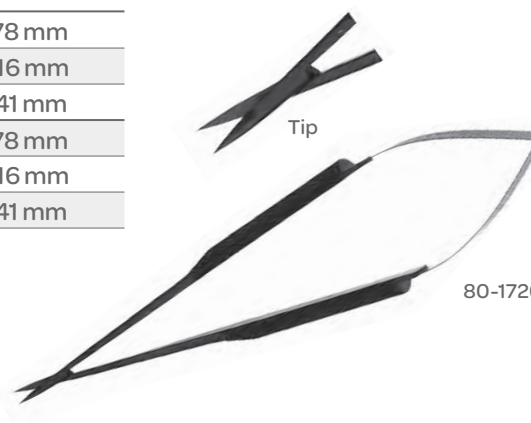

Scissors (Neuro)

Spetzler Neuro-Vascular Scissors

4.0 mm Tip, Titanium, Bayonet

CODE	DESCRIPTION	WORKING DISTANCE	LENGTH
80-1907	Straight Tip	4 in 102 mm	9½ in 241 mm
80-1908	Curved 30° Tip	4 in 102 mm	9½ in 241 mm



80-1907

Strully Neurological Scissors

CODE	DESCRIPTION	LENGTH
54-1046	Curved, Dissecting Tip	8 in 203 mm



Taylor Dural Scissors

CODE	DESCRIPTION	LENGTH
54-1050	Angled	5¾ in 146 mm



Scissors (Operating)

Deaver Operating Scissors

CODE	DESCRIPTION	LENGTH
54-4066	Straight, Sharp/Blunt	5½ in 140 mm



Scissors (Operating)

Operating Classic Plus® Scissors

Stellite Edge Inserts

CODE	DESCRIPTION	LENGTH
36-5040	Straight, Sharp/Blunt	5½ in 140 mm



Operating Scissors

Beveled Blades

CODE	DESCRIPTION	LENGTH
03-0211	Straight, Blunt/Blunt	4½ in 114 mm
03-0214	Straight, Blunt/Blunt	5½ in 140 mm
03-0215	Straight, Blunt/Blunt	6 in 152 mm
03-0283	Straight, Blunt/Blunt, Slender Pattern	5 in 127 mm
03-0216	Straight, Blunt/Blunt, Slender Pattern	6½ in 165 mm
03-0411	Straight, Sharp/Sharp Tips	4¾ in 121 mm
03-0413	Straight, Sharp/Sharp Tips	5 in 127 mm
03-0414	Straight, Sharp/Sharp Tips	5¾ in 146 mm
03-0415	Straight, Sharp/Sharp Tips	6 in 152 mm
03-0311	Curved, Blunt/Blunt	4½ in 114 mm
03-0314	Curved, Blunt/Blunt	5¾ in 146 mm
03-0383	Curved, Blunt/Blunt, Slender Pattern	5 in 127 mm
03-0511	Curved, Sharp/Sharp Tips	4½ in 114 mm
03-0513	Curved, Sharp/Sharp Tips	5 in 127 mm
03-0514	Curved, Sharp/Sharp Tips	5¾ in 146 mm
03-0515	Curved, Sharp/Sharp Tips	6½ in 156 mm



03-0211

Scissors (Operating)

Operating Scissors

Sharp/Blunt Tips, Beveled Blades

CODE	DESCRIPTION	LENGTH
03-0611	Straight	4 ³ / ₄ in 121 mm
03-0613	Straight	5 in 127 mm
03-0614	Straight	5 ³ / ₄ in 146 mm
03-0615	Straight	6 in 152 mm
03-0618	Straight	7 ¹ / ₄ in 184 mm



03-0611

Operating Scissors

Tungsten Carbide Cutting Edges

CODE	DESCRIPTION	LENGTH
32-600	Straight, Sharp/Blunt	5 ¹ / ₂ in 140 mm
32-640	Straight, Blunt/Blunt	5 ¹ / ₂ in 140 mm
32-630	Curved, Sharp/Sharp	5 ¹ / ₂ in 140 mm



32-600

Operating Scissors

Delicate Pattern

CODE	DESCRIPTION	LENGTH
54-4300	Straight, Sharp/Blunt	5 in 127 mm
54-4301	Straight, Sharp/Sharp	5 in 127 mm
54-4306	Straight, Sharp/Blunt	5 ¹ / ₂ in 140 mm



54-4300

Operating Scissors

CODE	DESCRIPTION	LENGTH
54-4026	Straight, Sharp/Blunt	5 in 127 mm
54-4027	Straight, Sharp/Sharp	5 in 127 mm
54-4028	Straight, Blunt/Blunt	5 ¹ / ₂ in 140 mm



54-4027

Scissors (Operating)

Operating Scissors

CODE	DESCRIPTION	LENGTH
54-4034	Straight, Blunt/Blunt	6½ in 165 mm
54-4029	Straight, Sharp/Blunt	5½ in 140 mm
54-4032	Straight, Sharp/Blunt	6 in 152 mm
54-4035	Straight, Sharp/Blunt	6½ in 165 mm
54-4030	Straight, Sharp/Sharp	5½ in 140 mm



54-4029

Razor Edge Operating Scissors

One Blade Serrated, Gold Screws

CODE	DESCRIPTION	LENGTH
203.06.14	Straight, Sharp/Blunt	5¾ in 146 mm



Sims Operating Scissors

Sharp/Blunt, Beveled Blades

CODE	DESCRIPTION	LENGTH
03-3420	Straight	8 in 203 mm



Scissors (Stitch)

Gradle Stitch Scissors

Sharp Tips, Flat Shanks, Large Ribbon Ring Handles, Curved

CODE	DESCRIPTION	LENGTH
60-1812	Extra Delicate Blades	3¾ in 95 mm
60-1813	Delicate Blades	3¾ in 95 mm



60-1813

Scissors (Stitch)

Littauer Stitch Scissors

CODE	DESCRIPTION	LENGTH
54-4017	Stitch Scissors	5½ in 140 mm



Spencer Stitch Scissors

CODE	DESCRIPTION	LENGTH
54-6624	Stitch Scissors	3½ in 89 mm
14-0609	Stitch Scissors, Delicate	3½ in 89 mm
54-4205	Stitch Scissors	4½ in 114 mm
14-0610	Stitch Scissors, Regular	4½ in 114 mm
14-0612	Stitch Scissors, Slender	4½ in 114 mm



54-6624

Wescott Stitch Scissors

CODE	DESCRIPTION	LENGTH
54-6630	Sharp/Sharp	4¼ in 108 mm



Scissors (Suture)

New Suture Scissors

CODE	DESCRIPTION	LENGTH
54-2550	Angled On Side	5½ in 140 mm



Scissors (Suture Wire)

Suture Wire Scissors

One Blade Serrated, Tungsten Carbide Cutting Edges

CODE	DESCRIPTION	LENGTH
32-900	Angled	5 in 127 mm



Scissors (Tenotomy)

Metzenbaum Razor Edge Tenotomy Scissors

Tenotomy, Razor Edge Blades, Black Handle

CODE	DESCRIPTION	LENGTH
80-3620	Straight	9 in 229 mm

Potts Razor Edge Scissors

One Blade with Micro Serrations, Black Handle with Gold Screw

CODE	DESCRIPTION	LENGTH
214.56.77	Straight	8 in 203 mm
214.55.77	Curved	8 in 203 mm



214.55.77

Reynolds Scissors

Tenotomy Tips, Curved

CODE	DESCRIPTION	LENGTH
55-1012	Serrated Edge	6 in 152 mm
55-1014	Serrated Edge	7 in 178 mm
55-1013	Plain Edge	7 in 178 mm



55-1012

Scissors (Tenotomy)

Steven Tenotomy Razor Edge Scissors

One Blade with Micro Serrations, Black Handle with Gold Screw

CODE	DESCRIPTION	LENGTH
212.50.12	Straight	4½ in 114 mm
212.50.13	Curved	4½ in 114 mm



212.50.13

Stevens Tenotomy Scissors

Tungsten Carbide Cutting Edges

CODE	DESCRIPTION	LENGTH
32-708	Straight	4½ in 114 mm
32-709	Curved	4½ in 114 mm



32-708

Stevens Tenotomy Razor Edge Scissors

Razor Edge Blades, Black Handle

CODE	DESCRIPTION	LENGTH
80-5012	Straight	5 in 127 mm
80-5025	Straight	7 in 178 mm
80-5009	Curved	4½ in 114 mm
80-5013	Curved	5 in 127 mm
80-5125	Curved	7 in 178 mm



80-5012

Scissors (Tenotomy)

Stevens Serrated Tenotomy Scissors

Razor Edge Blades, Black Handle , One Blade Serrated

CODE	DESCRIPTION	LENGTH
85-2001	Straight	4 ½ in 114 mm
86-5012	Straight	4 ½ in 114 mm
85-2002	Curved	4 ½ in 114 mm
85-2601	Curved	4 ½ in 114 mm
86-5013	Curved	4 ½ in 114 mm
86-5111	Curved	5 ½ in 140 mm
86-5125	Curved	7 in 178 mm



86-5012

Stevens Tenotomy Ceramic Coated Scissors

One Blade with Micro Serrations, Tungsten Carbide Cutting Edges, Black Ceramic Coating

CODE	DESCRIPTION	LENGTH
222.50.62	Straight, Delicate	4 ½ in 105 mm
222.50.63	Curved, Delicate	4 ½ in 105 mm
224.67.63	Curved, Delicate	5 ½ in 130 mm



222.50.62

Stevens Tenotomy Scissors

CODE	DESCRIPTION	LENGTH
54-6520	Straight	4 ½ in 105 mm
54-6522	Straight	4 5/8 in 117 mm
54-6521	Curved	4 ½ in 105 mm
54-6523	Curved	4 5/8 in 117 mm



54-6520

Scissors (Tenotomy)

Strabismus Scissors

Blunt Tips, Tungsten Carbide Cutting Edges

CODE	DESCRIPTION	LENGTH
32-701	Straight	4½ in 114 mm
32-671	Straight, One Blade Serrated	4½ in 114 mm
32-700	Curved	4½ in 114 mm
32-670	Curved, One Blade Serrated	4½ in 114 mm



32-670

Strabismus Classic Plus® Scissors

Blunt/Blunt, Stellite Edge Inserts

CODE	DESCRIPTION	LENGTH
36-5005	Straight	4½ in 114 mm



Strabismus Scissors

Blunt/Blunt

CODE	DESCRIPTION	LENGTH
54-6515	Straight	4½ in 114 mm
34-6517	Curved	4½ in 114 mm
54-6517	Curved	4½ in 114 mm



34-6517

Scissors (Tenotomy)

Razor Edge Serrated Stevens Tenotomy Scissors

One Blade Serrated, Gold Screw

CODE	DESCRIPTION	LENGTH
202.50.12	Straight	4 ½ in 114 mm
202.50.13	Curved	4 ½ in 114 mm
204.67.13	Curved	5 ⅞ in 130 mm



202.50.13

Stevens Tenotomy Scissors

CODE	DESCRIPTION	LENGTH
02-5002	Straight, Sharp Tips	4 in 102 mm
02-5003	Curved, Sharp Tips	4 in 102 mm



02-5002

Wescott Tenotomy Scissors

CODE	DESCRIPTION	LENGTH
54-6513	Blunt/Blunt	4 ¼ in 108 mm



Scissors (Tenotomy)

Potts Tenotomy Scissors

Tenotomy Tips

CODE	DESCRIPTION	LENGTH
04-5677	Curved	8 in 203 mm



Stevens Tenotomy Scissors

Blunt Tips

CODE	DESCRIPTION	LENGTH
02-5012	Straight	4 1/8 in 105 mm
02-5110	Straight	5 1/2 in 140 mm
02-5013	Curved	4 1/8 in 105 mm
02-5111	Curved	5 1/2 in 140 mm
02-5123	Curved	6 1/2 in 165 mm
02-5125	Curved	7 in 178 mm

60-1804	Straight, Light Pattern, Flat Shanks, Large Ribbon Ring Handles	4 in 102 mm
60-1807	Curved, Light Pattern, Flat Shanks, Large Ribbon Ring Handles	4 in 102 mm



02-5012



60-1804

Scissors (Tissue)

Calcified Tissue Scissors

CODE	DESCRIPTION	LENGTH
54-8024	Curved, Serrated Blades	9 in 229 mm



Scissors (Tissue & Gum)

Fox Tissue & Gum Scissors

Tungsten Carbide Cutting Edges

CODE	DESCRIPTION	LENGTH
32-941	Straight	5 $\frac{1}{8}$ in 130 mm
32-940	Curved	5 $\frac{1}{8}$ in 130 mm



32-941

Scissors (Umbilical)

American Umbilical Scissors

CODE	DESCRIPTION	LENGTH
54-5545	Umbilical Scissors	4 in 102 mm



Busch Umbilical Scissors

CODE	DESCRIPTION	LENGTH
54-5578	Curved On Side	6 $\frac{1}{2}$ in 165 mm



Scissors (Uterine)

Sims Uterine Scissors

CODE	DESCRIPTION	LENGTH
54-5500	Straight, Blunt/Blunt	8 in 203 mm
54-5503	Curved, Blunt/Blunt	8 in 203 mm



54-5500

Scissors (Utility)

Utility Scissors

Blunt, Flat Shanks, Large Ribbon Ring Handles

CODE	DESCRIPTION	LENGTH
60-1853	Lightly Curved	4 in 102 mm

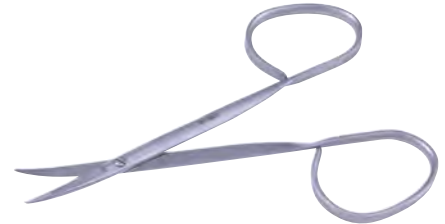

Scissors (Vascular)

Cooley "My Scissor" Ceramic Coated Scissors

Razor Edge with Micro Serrations On One Blade, Black Ceramic Coating

CODE	DESCRIPTION	LENGTH
84-1350	Curved	7¼ in 184 mm



DeBakey-Potts Scissors

Angled, Tungsten Carbide Cutting Edges

CODE	DESCRIPTION	LENGTH
32-172	25°	7 in 178 mm
32-176	45°	9 in 229 mm



32-172

DeBakey-Metzenbaum Scissors

Tungsten Carbide Edges

CODE	DESCRIPTION	LENGTH
32-3576	Straight	12¼ in 311 mm



Scissors (Vascular)

Diethrich Scissors

Angled, One Blade Serrated, Tungsten Carbide Cutting Edges

CODE	DESCRIPTION	LENGTH
32-844	25°	7 in 178 mm
32-845	45°	7 in 178 mm
32-846	60°	7 in 178 mm
32-847	90°	7 in 178 mm
65-848	120°	7 in 178 mm



Diethrich Vascular Ceramic Coated Scissors

Angled, Razor Edges with Serrations on One Blade, Tungsten Carbide Cutting Edges, Black Ceramic Coating

CODE	DESCRIPTION	LENGTH
225.15.32	25°	7¼ in 184 mm
225.15.34	45°	7⅝ in 181 mm
225.15.36	60°	7 in 178 mm
225.15.39	90°	6¾ in 171 mm



Diethrich Vascular Ceramic Coated Scissors

Angled, Razor Edges and Micro Serrations, Tungsten Carbide Cutting Edges, Black Ceramic Coating

CODE	DESCRIPTION	LENGTH
225.15.40	125°	7⅝ in 181 mm

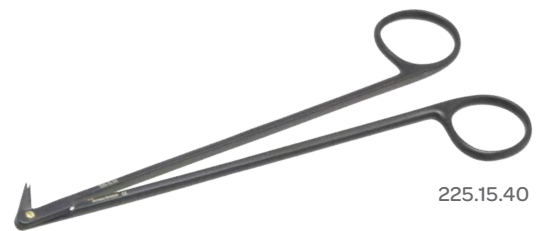

Litwak Mitral Valve Scissors

One Blade Serrated, Gold Screw

CODE	DESCRIPTION	LENGTH
54-8023	Angled On Side	11 in 279 mm



Scissors (Vascular)

Micro Vascular Scissors

Angled, Extra Delicate, Round Handle

CODE	DESCRIPTION	LENGTH
55-8062	120°	6¾ in 171 mm
55-8058	25°	7 in 178 mm
55-8059	45°	7 in 178 mm
55-8060	60°	7 in 178 mm
55-8061	90°	7 in 178 mm
55-8091	25°	8¼ in 210 mm
55-8092	45°	8¼ in 210 mm
55-8094	90°	8¼ in 210 mm
55-8095	120°	8¼ in 210 mm



Micro Vascular Scissors

Angled, Delicate Tips, Flat Handle

CODE	DESCRIPTION	LENGTH
55-8160	25°	6¾ in 171 mm
55-8165	45°	6¾ in 171 mm
55-8170	60°	6¾ in 171 mm
55-8175	90°	6¾ in 171 mm
55-8178	120°	6¾ in 171 mm

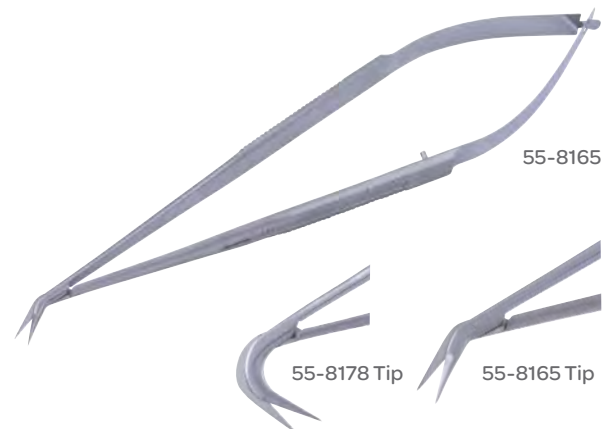

Potts-Smith Scissors

Angled, Tungsten Carbide Cutting Edges

CODE	DESCRIPTION	LENGTH
32-191	25°	7½ in 191 mm
32-192	45°	7½ in 191 mm
32-193	60°	7½ in 191 mm



Scissors (Vascular)

Potts Tenotomy Ceramic Coated Scissors

One Blade with Micro Serrations, Tungsten Carbide Cutting Edges, Black Ceramic Coating

CODE	DESCRIPTION	LENGTH
224.56.77	Curved	8 in 203 mm



Potts Tenotomy Scissors

CODE	DESCRIPTION	LENGTH
37-4032	Curved	6 in 152 mm



Potts-Smith Ceramic Coated Scissors

Angled, Razor Edge with Micro Serrations on One Blade, Tungsten Carbide Cutting Edges, Black Ceramic Coating

CODE	DESCRIPTION	LENGTH
225.15.43	25°	7¼ in 184 mm
225.15.44	45°	7¼ in 184 mm
225.15.46	60°	7¼ in 184 mm



Potts-Smith Razor Edge Serrated Scissors

One Blade Serrated, Gold Screw

CODE	DESCRIPTION	LENGTH
255.15.42	Angled 25°	7½ in 191 mm
255.15.44	Angled 45°	7½ in 191 mm

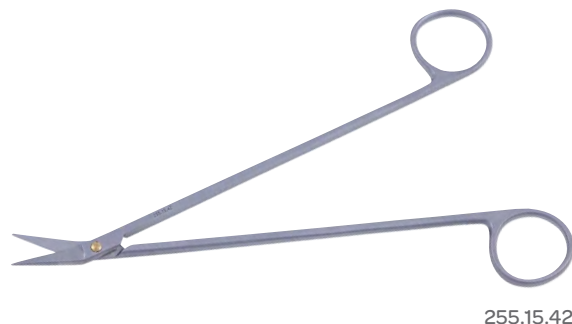

Scissors (Vascular)

Micro Vascular Scissors

Titanium, Angled, Extra Delicate, Round Handle

CODE	DESCRIPTION	TIPS	LENGTH
80-1801	Straight		7 in 178 mm
80-1802	Curved		7 in 178 mm
80-1803	Straight	Angled, 60°	7 in 178 mm
80-1804	Right Curved	Angled, 60°	7 in 178 mm
80-1805	Left Curved	Angled, 60°	7 in 178 mm

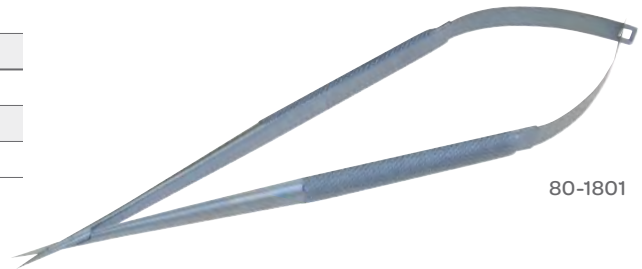

80-1801

Scissors (Wire)

Wire Classic Plus® Suture Scissors

Stellite Edge Inserts

CODE	DESCRIPTION	LENGTH
36-5080	Angled	4 ¾ in 121 mm



Wire Cutting Suture Scissors

CODE	DESCRIPTION	LENGTH
54-4210	Serrated Blade	4 ½ in 114 mm



Wire Cutting Suture Scissors

One Serrated Jaw

CODE	DESCRIPTION	LENGTH
54-4110	Angled	4 ¾ in 121 mm



Scissors (Wire)

Beebee Wire Scissors

One Serrated Blade, Sharp Tips

CODE	DESCRIPTION	LENGTH
14-2410	Straight	4½ in 114 mm



Schuknecht Wire Cutting Scissors

CODE	DESCRIPTION	LENGTH
14-2009	Wire Cutting Scissors	4 in 102 mm



Wire Cutting Scissors

One Serrated Jaw

CODE	DESCRIPTION	LENGTH
14-2312	Angled	4¾ in 121 mm



Scoops (Common Duct)

Mayo Common Duct Scoop

Silver-Plated

CODE	SIZE	WIDTH	LENGTH
51-1204	Small	4.0 mm	10 in 254 mm
51-1205	Medium	5.0 mm	10 in 254 mm



51-1204

Scoops (Gall Stone)

Desjardins Gall Stone Scoop

CODE	DESCRIPTION	LENGTH	
51-1406	18 French, Flexible Shaft	12 in	305 mm

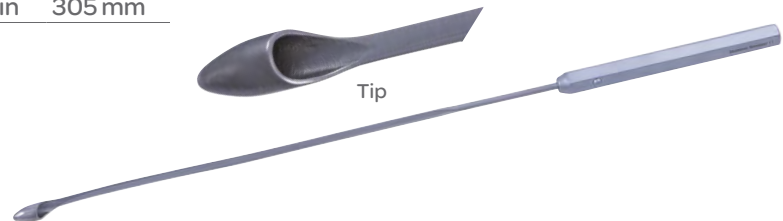

Fergusson Gall Stone Scoop

Double-Ended

CODE	SIZE	SCOOPS	LENGTH	
51-1501	Small	7.0 mm/9.0 mm	9½ in	241 mm
51-1503	Large	13 mm/14 mm	9½ in	241 mm

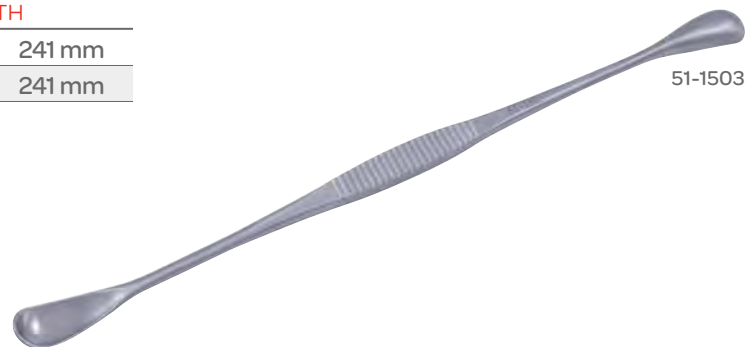

Spatulas

Davis Brain Spatula

Malleable, Stainless Steel, Double-Ended

CODE	DESCRIPTION		LENGTH	
59-1080	¼ in	6.0 mm	7 in	178 mm
59-1081	⅜ in	10 mm	7 in	178 mm
59-1082	½ in	13 mm	7 in	178 mm
59-1083	⅝ in	16 mm	7 in	178 mm
59-1084	¾ in	19 mm	7 in	178 mm
59-1085	1 in	25 mm	7 in	178 mm
59-1086	1¼ in	32 mm	7 in	178 mm
59-1087	1½ in	38 mm	7 in	178 mm



Spatulas

Scoville Brain Spatulas

Malleable, Double Ended

CODE	BLADE WIDTHS	LENGTH
59-1070	$\frac{3}{8}$ in and $\frac{1}{2}$ in	10 mm and 13 mm 8 in 203 mm
59-1071	$\frac{5}{8}$ in and $\frac{3}{4}$ in	16 mm and 19 mm 8 in 203 mm



59-1071

Spatula

CODE	DESCRIPTION	LENGTH
43-8504	Spatula and Packer	5 $\frac{3}{4}$ in 146 mm
43-8505	Excavator and Packer	5 $\frac{3}{4}$ in 146 mm



43-8504

Sponges

Secto® Tonsil Sponges

X-Ray Detectable, Sterile, 5 per A Card/Pouch, 25 Pouches per Dispenser, 2 Dispenser Boxes per Case

CODE	CORD LENGTH	DIAMETER
81-1010	10 in 254 mm	$\frac{5}{8}$ in 16 mm
81-1011	10 in 254 mm	1 in 25 mm
81-1012	10 in 254 mm	1 $\frac{1}{4}$ in 32 mm



81-1011

Stringers

Bunts Forceps Holder

CODE	DESCRIPTION	LENGTH
28-4008	One Dozen Per Package	3 $\frac{7}{8}$ in 98 mm



Stringers

Instrument Stringer

2½ in (64 mm) Wide

CODE	DESCRIPTION	LENGTH
51-0006	With Bar	6 in 152 mm
51-0006B	With Ball Closure	6 in 152 mm
51-0008	With Bar	8 in 203 mm
51-0008B	With Ball Closure	8 in 203 mm
51-0010	With Bar	10 in 254 mm
51-0010B	With Ball Closure	10 in 254 mm
51-0012	With Bar	12 in 305 mm
51-0016	With Bar	16 in 406 mm

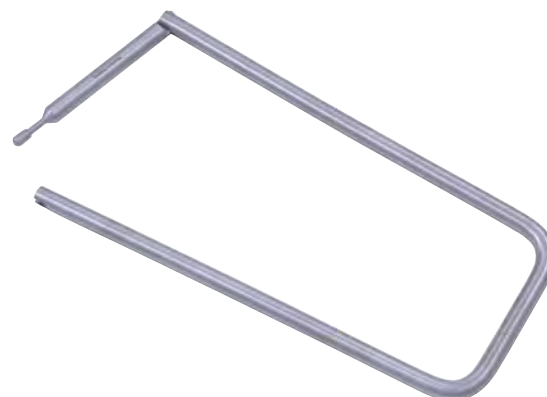

51-0006

Instrument Stringer

Open Without Bar

CODE	DIMENSIONS	LENGTH
52-0006	2½ x 6 in 64 x 152 mm	6 in 152 mm
52-0008	2½ x 8 in 64 x 203 mm	8 in 203 mm
52-0010	2½ x 10 in 64 x 254 mm	10 in 254 mm
52-0012	2½ x 12 in 64 x 305 mm	12 in 305 mm
52-0014	2½ x 14 in 64 x 356 mm	14 in 356 mm
52-0016	2½ x 16 in 64 x 406 mm	16 in 406 mm

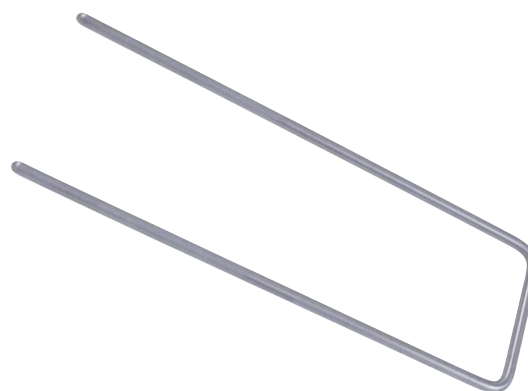

52-0008

Instrument Stringer

Ball Closure

CODE	DESCRIPTION	LENGTH
ST-6	Stainless Steel	6 in 152 mm
ST-8	Stainless Steel	8 in 203 mm
ST-10	Stainless Steel	10 in 254 mm
ST-12	Stainless Steel	12 in 305 mm
ST-14	Stainless Steel	14 in 356 mm
ST-16	Stainless Steel	16 in 406 mm
ST-18	Stainless Steel	18 in 458 mm
ST-20	Stainless Steel	20 in 508 mm



ST-10

Stringers

Posilock Instrument Stringer

With T-Bar

CODE	WIDTH		LENGTH	
50-0006	2½ in	64 mm	6 in	152 mm
50-0008	2½ in	64 mm	8 in	203 mm
50-0010	2½ in	64 mm	10 in	254 mm
50-0012	2½ in	64 mm	12 in	305 mm
50-0014	2½ in	64 mm	14 in	356 mm
50-0016	2½ in	64 mm	16 in	406 mm

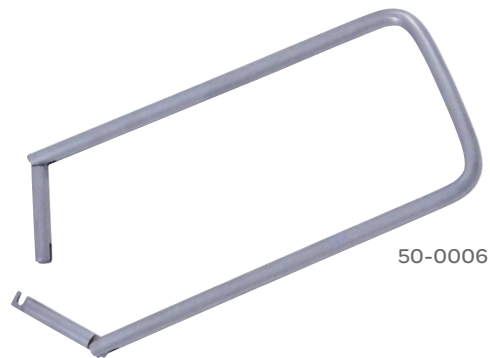

50-0006

Weisenbach Instrument Stringer

With T-Bar

CODE	WIDTH		LENGTH	
50-0011	2½ in	64 mm	6 in	152 mm
50-0009	2½ in	64 mm	12 in	305 mm



50-0011

Mayo Instrument Stringer

CODE	DESCRIPTION	LENGTH
46-2810	Instrument Stringer	5½ in 140 mm



Rhode Island Hospital Instrument Stringer

CODE	DESCRIPTION	LENGTH
21-4003	Instrument Holder	12 in 305 mm

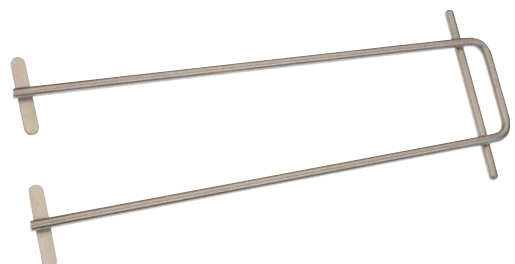

Stringers

Instrument Stringer

For Ring Handle Forceps

CODE	DIMENSIONS
32-3346	5 ⁷ / ₈ x 3 ¹ / ₈ in 149 x 79 mm
32-3347	7 ⁷ / ₈ x 3 ¹ / ₈ in 200 x 79 mm
32-3348	9 ⁷ / ₈ x 3 ¹ / ₈ in 251 x 79 mm

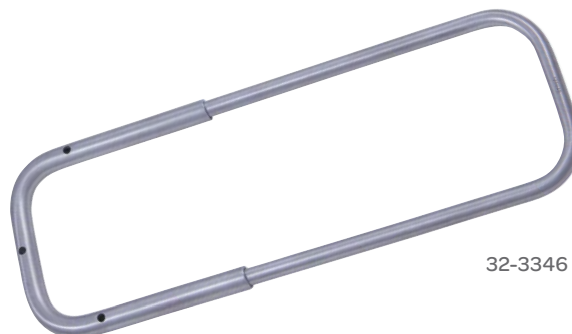

32-3346

Weinstein Instrument Stringer

CODE	DESCRIPTION	LENGTH
51-0006W	Horseshoe Shape	6 in 152 mm
51-0008W	Horseshoe Shape	8 in 203 mm
51-0010W	Horseshoe Shape	10 in 254 mm
51-0012W	Horseshoe Shape	12 in 305 mm



51-0006W

Weisenbach Instrument Stringer

CODE	DESCRIPTION	LENGTH
28-4010	T-Bar	6 in 152 mm
28-4011	T-Bar	12 in 305 mm



28-4010

Suction Tubes (Liposuction)

Liposuction Tube

CODE	DESCRIPTION	SIZE	LENGTH	
52-9301	Straight	3.0 mm #1	6 in	152 mm
52-9303	Straight	4.0 mm #3	9 ⁷ / ₈ in	251 mm
52-9305	Straight	9.0 mm #5	11 ³ / ₄ in	298 mm
52-9307	Curved	6.0 mm #7	6 in	152 mm

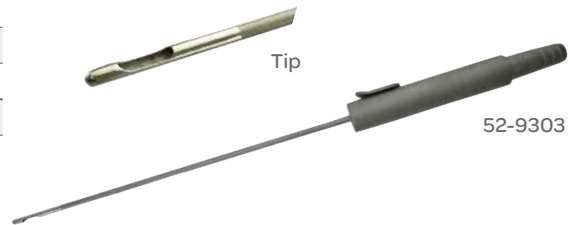

52-9303

Suction Tubes

Adson Suction Tube

Curved

CODE	DESCRIPTION	LENGTH	
09-8115	15 French	7 ¹ / ₂ in	191 mm
09-8110	10 French	8 ¹ / ₄ in	210 mm
09-8114	14 French	8 ¹ / ₄ in	210 mm



09-8115

Adson Suction Tube

Curved, with Thumb Control

CODE	DESCRIPTION	LENGTH	
70-1146	12 French	5 ¹ / ₂ in	140 mm
70-1148	15 French	7 ¹ / ₂ in	191 mm



70-1146

Suction Tubes

Andrews-Pynchon Suction Tube

CODE	DESCRIPTION	LENGTH	
09-8508	With Removable Tip	9½ in	241 mm
09-8506	With Removable Tip	10½ in	267 mm
09-8509	With Removable Shaft	9½ in	241 mm



09-8508

Andrews-Pynchon Suction Tube

CODE	DESCRIPTION	LENGTH	
70-6560	Non-Removable Tip	9½ in	241 mm
67-7675	Opti-Length®	11 in	279 mm



67-7675

Anthony Suction Tube

2.0 mm Diameter

CODE	DESCRIPTION	LENGTH	
61-1067	Straight	10 in	254 mm
09-8510	Angled	10 in	254 mm



09-8510

Baron Suction Tube

CODE	DESCRIPTION	WORKING LENGTH	LENGTH	
62-2210	3 French	3 in 76 mm	5⅛ in	130 mm
62-2215	5 French	3 in 76 mm	5⅛ in	130 mm
62-2220	7 French	3 in 76 mm	5⅛ in	130 mm
62-2210L	3 French, Long	3½ in 89 mm	6⅛ in	156 mm
62-2215L	5 French, Long	3½ in 89 mm	6⅛ in	156 mm
62-2220L	7 French, Long	3½ in 89 mm	6⅛ in	156 mm

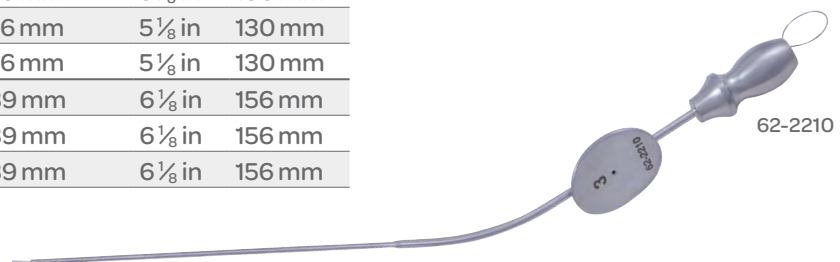

62-2210

Suction Tubes

Baron Obturator

CODE	DESCRIPTION	GAUGE
62-2210S	Baron Obturator (Stylet) Wire	3 French
62-2215S	Baron Obturator (Stylet) Wire	5 French
62-2220S	Baron Obturator (Stylet) Wire	7 French



Brackman Suction Tube

Offset Suction Tip Holes

CODE	DESCRIPTION	LENGTH
09-9505	5 French	3 in 76 mm
09-9507	7 French	3 in 76 mm



Brand Suction Tube

CODE	DESCRIPTION	LENGTH
50-9826	6.0 mm Diameter	15 3/4 in 400 mm

DeBakey Suction Tube

CODE	DESCRIPTION	LENGTH
09-8507	Curved	11 in 279 mm



Suction Tubes

Ferguson-Frazier Suction Tube

Strong Angle

CODE	DESCRIPTION	LENGTH
61-1021	6 French	4 in 102 mm
61-1022	7 French	4 in 102 mm
61-1023	8 French	4 in 102 mm
61-1024	9 French	4 in 102 mm
61-1025	10 French	4 in 102 mm
61-1026	12 French	4 in 102 mm
61-1027	14 French	4 in 102 mm



61-1021

Frazier Suction Tube

Medium Angle

CODE	DESCRIPTION	TUBE LENGTH
09-8303	3 French	4 in 102 mm
09-8304	4 French	4 in 102 mm
09-8305	5 French	4 in 102 mm
09-8306	6 French	4 in 102 mm
09-8307	7 French	4 in 102 mm
09-8308	8 French	4 in 102 mm
09-8309	9 French	4 in 102 mm
09-8310	10 French	4 in 102 mm
09-8311	11 French	4 in 102 mm
09-8312	12 French	4 in 102 mm
09-8314	14 French	4 in 102 mm
09-8315	15 French	4 in 102 mm

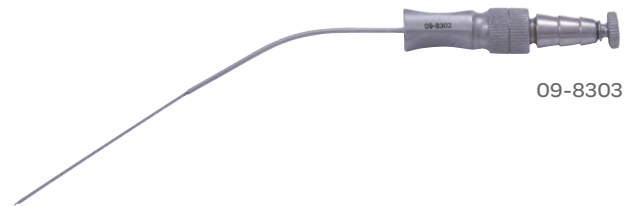

09-8303

Frazier Suction Tube

Medium Angle, Extra Long

CODE	DESCRIPTION	TUBE LENGTH
09-8376	6 French	7½ in 191 mm
09-8377	7 French	7½ in 191 mm
09-8378	8 French	7½ in 191 mm
09-8379	9 French	7½ in 191 mm
09-8380	10 French	7½ in 191 mm
09-8381	11 French	7½ in 191 mm
09-8382	12 French	7½ in 191 mm
09-8383	14 French	7½ in 191 mm

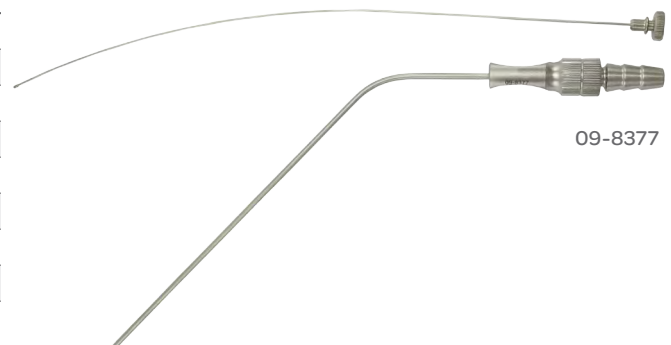

09-8377

Suction Tubes

Frazier Suction Tube

Malleable

CODE	DESCRIPTION	LENGTH
09-8603	3 French	7½ in 191 mm
09-8605	5 French	7½ in 191 mm
09-8607	7 French	7½ in 191 mm
09-8608	8 French	7½ in 191 mm
09-8612	12 French	7½ in 191 mm
09-8614	14 French	8½ in 216 mm



09-8603

Frazier Suction Tube

Semi-Rigid with Slot

CODE	DESCRIPTION	LENGTH
09-8993	3 French	5½ in 140 mm
09-8995	5 French	5½ in 140 mm
09-8996	6 French	5½ in 140 mm
09-8997	7 French	5½ in 140 mm
09-8999	9 French	5½ in 140 mm
09-9001	11 French	5½ in 140 mm
09-9107	7 French	7 in 178 mm
09-9108	8 French	7 in 178 mm
09-9109	9 French	7 in 178 mm
09-9111	11 French	7 in 178 mm
09-9112	12 French	7 in 178 mm



09-8993

Frazier Suction Tube

Straight

CODE	DESCRIPTION	LENGTH
57-3910	6 French	7 in 178 mm
57-3911	7 French	7 in 178 mm
57-3912	8 French	7 in 178 mm
57-3914	10 French	7 in 178 mm
57-3916	12 French	7 in 178 mm
57-3930	7 French, Round Hole	9 in 229 mm
57-3932	9 French, Round Hole	9 in 229 mm
57-3934	11 French, Round Hole	9 in 229 mm



57-3911

Suction Tubes

Frazier Suction Tube

Malleable, Calibration at 5.0-9.0 cm, Angled with Calibration

CODE	GAUGE	TUBE LENGTH	LENGTH
63-7554	4 French	4 in 102 mm	6 ³ / ₄ in 171 mm
63-7557	7 French	4 in 102 mm	6 ³ / ₄ in 171 mm
63-7558	8 French	4 in 102 mm	6 ³ / ₄ in 171 mm
63-7559	9 French	4 in 102 mm	6 ³ / ₄ in 171 mm
63-7553	10 French	4 in 102 mm	6 ³ / ₄ in 171 mm

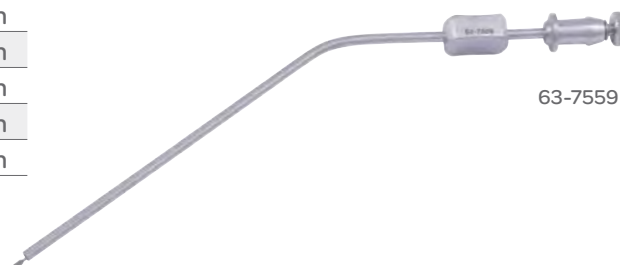

63-7559

Frazier Suction Tube

Straight with Thumb Control

CODE	DESCRIPTION	TUBE LENGTH
70-1005	Angular Insulated, 9 French	4 ¹ / ₂ in 114 mm
70-1006	Angular Insulated, 11 French	4 ¹ / ₂ in 114 mm
70-1079	Angular, 7 French	4 ¹ / ₂ in 114 mm
70-1080	Angular, 9 French	4 ¹ / ₂ in 114 mm
70-1100	7 French	5 ¹ / ₄ in 133 mm
70-1101	9 French	5 ¹ / ₄ in 133 mm
70-1102	11 French	5 ¹ / ₄ in 133 mm



70-1101

Frazier Suction Tube Stylet

CODE	DESCRIPTION
09-8336	6 French, for 09-8306
09-8337	7 French, for 09-8307
09-8338	8 French, for 09-8308
09-8339	9 French, for 09-8309
09-8340	10 French, for 09-8310
09-8342	12 French, for 09-8312
09-8343	14 French, for 09-8314

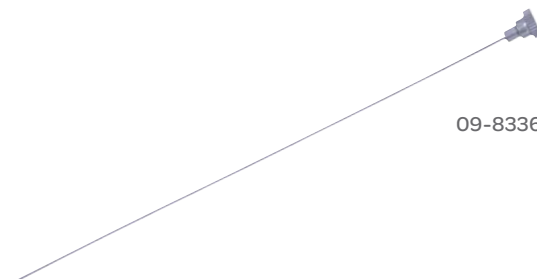

09-8336

Suction Tubes

Fukushima Tapered Teardrop Suction Tube

Malleable

CODE	DESCRIPTION	LENGTH
67-7850	4 French	6¼ in 159 mm
67-7851	5 French	6¼ in 159 mm
67-7852	6 French	6¼ in 159 mm
67-7853	7 French	6¼ in 159 mm
67-7854	8 French	6¼ in 159 mm
67-7855	9 French	6¼ in 159 mm



67-7850

Fukushima Tapered Teardrop Suction Tube

Malleable

CODE	DESCRIPTION	LENGTH
67-7856	4 French	7 in 178 mm
67-7857	5 French	7 in 178 mm
67-7858	6 French	7 in 178 mm
67-7859	7 French	7 in 178 mm
67-7860	8 French	7 in 178 mm
67-7861	9 French	7 in 178 mm



67-7856

Fukushima Tapered Teardrop Suction Tube

Malleable

CODE	DESCRIPTION	LENGTH
67-7862	4 French	8 in 203 mm
67-7863	5 French	8 in 203 mm
67-7864	6 French	8 in 203 mm
67-7865	7 French	8 in 203 mm
67-7866	8 French	8 in 203 mm
67-7867	9 French	8 in 203 mm



67-7862

Suction Tubes

Fukushima Tapered Teardrop Suction Tube

Malleable

CODE	DESCRIPTION	LENGTH
67-7868	4 French	9 in 229 mm
67-7869	5 French	9 in 229 mm
67-7870	6 French	9 in 229 mm
67-7871	7 French	9 in 229 mm
67-7872	8 French	9 in 229 mm
67-7873	9 French	9 in 229 mm

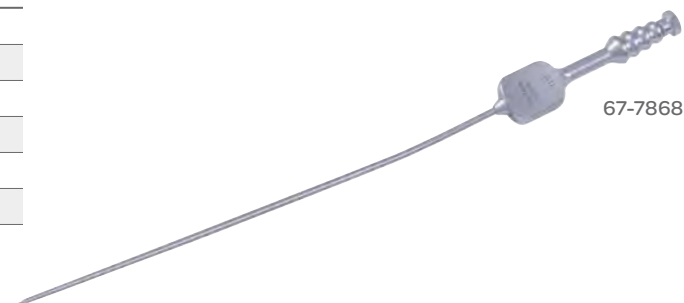

67-7868

Grafting Suction Tube

CODE	DESCRIPTION	LENGTH
09-8511	3.0 mm Tip	9½ in 241 mm

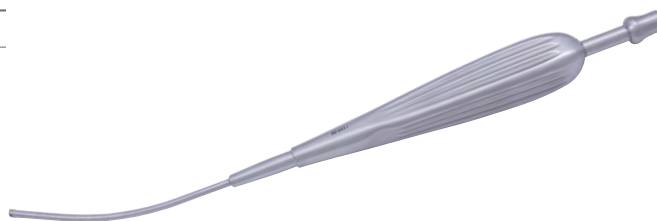

Guilford-Wright Suction Tube

With Obturator that Extends 6.0 mm Beyond Tube

CODE	DESCRIPTION	LENGTH
61-1050	18 Gauge	4 in 102 mm
61-1053	24 Gauge	4 in 102 mm

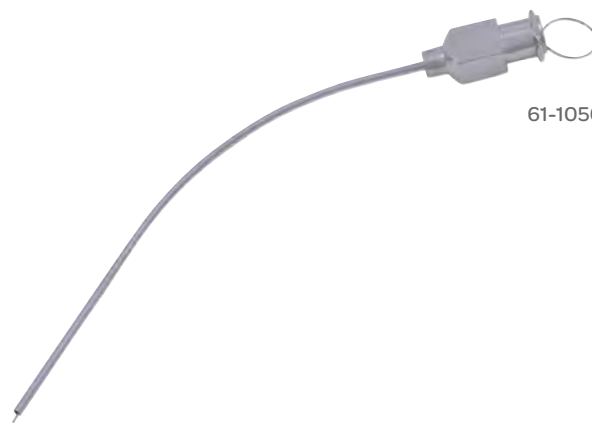

61-1050

Suction Tubes

Hardy™ Suction Tube

Angled, with Thumb Control, Insulated

CODE	DESCRIPTION	LENGTH
80-1360	7 French, Curved Left	7¼ in 184 mm
80-1361	7 French, Curved Right	7¼ in 184 mm

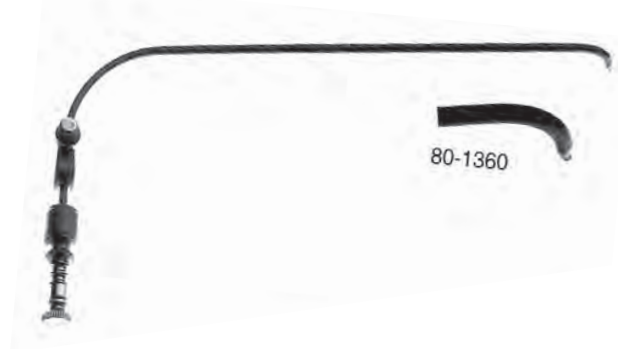

Malis®-Frazier Suction Tube

Black Anodized

CODE	DESCRIPTION	LENGTH
70-1103	7 French	4¼ in 108 mm
70-1104	7 French	7½ in 191 mm

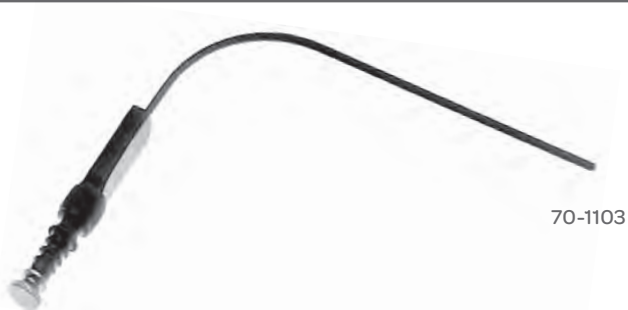

Methodist Vascular Suction Tube

CODE	DIAMETER	LENGTH
70-8040	⅜ in 10 mm	10 in 254 mm



Pacifico Suction Tube

Diameter Tapers 11-8 French

CODE	DESCRIPTION	LENGTH
70-8048	Large	7½ in 191 mm

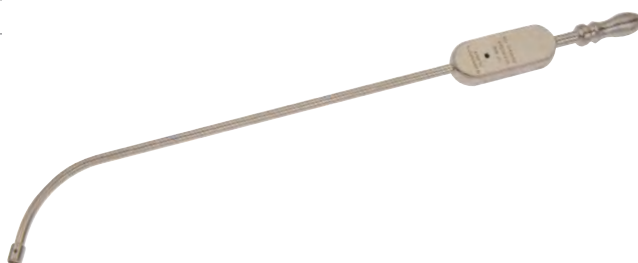

Suction Tubes

Poole Suction Tube

CODE	DESCRIPTION	LENGTH	
09-8717	17 French, Straight	8 in	203 mm
09-8730	30 French, Straight	8 ¾ in	222 mm
09-8799	30 French, Straight	12 in	305 mm
09-8800	30 French, Straight	14 in	356 mm
70-4001	30 French, Straight Tubing Connection	9 ⅝ in	244 mm
70-4002	30 French, Straight Tubing Connection, with Finger Cut-Off	10 ¼ in	260 mm
09-8823	23 French, Curved	8 ¾ in	222 mm
70-4000	23 French, Curved Tubing Connection	9 ¼ in	235 mm



70-4000

Suction Tube

CODE	WORKING DISTANCE		LENGTH	
32-3360	9 ¾ in	248 mm	12 in	305 mm
32-3361	12 ¾ in	324 mm	15 in	381 mm



32-3360

Pribram Suction Tube with Thumb Control

CODE	DESCRIPTION	LENGTH	
70-1128	16 Gauge	5 ½ in	140 mm
70-1130	18 Gauge	5 ½ in	140 mm



70-1128

Suction Tubes

Rhoton® Suction Tube

Angled Tube

CODE	GAUGE	TIP	LENGTH
58-6303	3 French	Straight	3¼ in 83 mm
58-6305	5 French	Straight	3¼ in 83 mm
58-6307	7 French	Straight	3¼ in 83 mm
58-6310	10 French	Straight	3¼ in 83 mm
58-6311	12 French	Straight	3¼ in 83 mm
58-6313	3 French	Straight	4 in 102 mm
58-6315	5 French	Straight	4 in 102 mm
58-6317	7 French	Straight	4 in 102 mm
58-6320	10 French	Straight	4 in 102 mm
58-6322	12 French	Straight	4 in 102 mm
58-6327	7 French	Straight	5½ in 140 mm
58-6330	10 French	Straight	5½ in 140 mm
58-6331	12 French	Straight	5½ in 140 mm
58-6335	5 French	Curved Up	5¼ in 133 mm
58-6337	7 French	Curved Up	5¼ in 133 mm
58-6340	10 French	Curved Up	5¼ in 133 mm



Rosen Suction Tube

CODE	DESCRIPTION	LENGTH
61-1035	15 Gauge	2¾ in 60 mm
61-1036	16 Gauge	2¾ in 60 mm
61-1037	17 Gauge	2¾ in 60 mm
61-1038	18 Gauge	2¾ in 60 mm
61-1039	19 Gauge	2¾ in 60 mm
61-1040	20 Gauge	2¾ in 60 mm
61-1041	22 Gauge	2¾ in 60 mm
61-1042	24 Gauge	2¾ in 60 mm
61-1043	26 Gauge	2¾ in 60 mm



Suction Tubes

Sachs Pediatric Suction Tube

CODE	DESCRIPTION
09-8520	#1, Fixed Tip, Fluted



Sachs Suction Tube

Angled, with Finger Valve and Obturator

CODE	DESCRIPTION	WORKING LENGTH
09-1970	10 French	4 in 102 mm
09-1980	15 French	4 in 102 mm



Sachs Suction Tube

CODE	DESCRIPTION	SHAFT LENGTH	TIP LENGTH
70-1160	Small, 8 French	9 5/8 in 244 mm	4 in 102 mm
70-1161	Large, 15 French	9 5/8 in 244 mm	4 1/2 in 114 mm



Suction Tubes

Sarns Suction Tube

CODE	DESCRIPTION
09-6600	#1 Fixed Tip, Fluted



Schuknecht Suction Tube

CODE	GAUGE	LENGTH
62-2230	20 Gauge	5 1/4 in 133 mm
62-2231	24 Gauge	5 1/4 in 133 mm



62-2231

Tear-Drop Suction Tube

Angled Tapered Tube, Malleable

CODE	GAUGE	WORKING LENGTH	LENGTH
57-4063	3 French	5 in 127 mm	6 in 152 mm
57-4064	4 French	5 in 127 mm	6 in 152 mm
57-4065	5 French	5 in 127 mm	6 in 152 mm
57-4066	6 French	5 in 127 mm	6 in 152 mm
57-4067	7 French	5 in 127 mm	6 in 152 mm
57-4068	8 French	5 in 127 mm	6 in 152 mm
57-4069	9 French	5 in 127 mm	6 in 152 mm
57-4070	10 French	5 in 127 mm	6 in 152 mm
57-4072	12 French	5 in 127 mm	6 in 152 mm
57-4073	3 French	6 in 152 mm	7 in 178 mm
57-4074	4 French	6 in 152 mm	7 in 178 mm
57-4075	5 French	6 in 152 mm	7 in 178 mm
57-4083	3 French	7 in 178 mm	8 in 203 mm
57-4086	6 French	7 in 178 mm	8 in 203 mm
57-4088	8 French	7 in 178 mm	8 in 203 mm
57-4090	10 French	7 in 178 mm	8 in 203 mm
57-4092	12 French	7 in 178 mm	8 in 203 mm



57-4065

Suction Tubes

Tear-Drop Suction Tube

CODE	GAUGE	LENGTH
57-4044	4 French	9 in 229 mm
57-4045	5 French	9 in 229 mm
57-4046	6 French	9 in 229 mm
57-4047	7 French	9 in 229 mm
57-4049	9 French	9 in 229 mm



57-4046

Vascular Suction Tube

Round Perforated End

CODE	DIAMETER	LENGTH
70-8036	¼ in 6.0 mm	11½ in 292 mm



Yankauer Suction Tube

CODE	DESCRIPTION	LENGTH
09-8504	Small Pattern, Narrow Handle	8¼ in 210 mm
09-8500		10¼ in 260 mm
70-4026	Standard Pattern, Removable Tip	10⅜ in 264 mm
70-4024	Thumb Control	11¼ in 286 mm
09-8599		12 in 305 mm
32-3362	Thumb Control, Tube Length 5⅞ in (149 mm)	12¾ in 324 mm
09-8600		14 in 356 mm
09-8640		16 in 405 mm



09-8500

Suction Tubes

Yasargil Micro Suction Tube

CODE	DESCRIPTION	LENGTH
80-1621	Medium, 2.5 mm Outer Diameter	14 in 356 mm
80-1622	Large, 3.5 mm Outer Diameter	14 in 356 mm



80-1621

Trocars

Ochsner Trocar

Round Perforated End

CODE	GAUGE	LENGTH
09-5812	12 French	6 in 152 mm
09-5818	18 French	6 in 152 mm
09-5822	22 French	6 in 152 mm
09-5824	24 French	6 in 152 mm

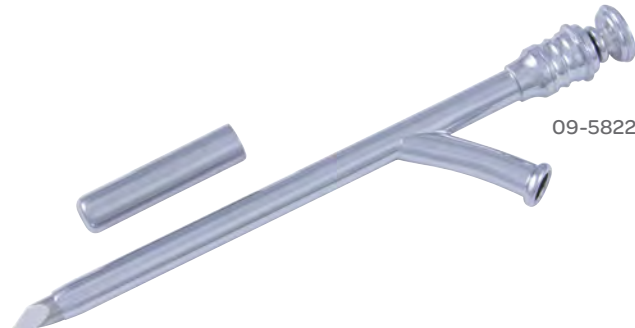

09-5822

Wire & Pin Cutters

Double Action Wire Cutter Side Cutter

CODE	DESCRIPTION	LENGTH
32-3371	Straight Jaw	9 in 229 mm
32-3372	Angled Jaw	6 ½ in 165 mm
32-3373	Angled Jaw	9 in 229 mm



32-3372

Wire & Pin Cutters

Kirschner Wire Cutter

CODE	DESCRIPTION	LENGTH
56-2507	Chrome Plated	11¼ in 286 mm



Wire Twisters

Wire Twister

Blunt Tips, Ring Handle

CODE	DESCRIPTION	LENGTH
32-122	Tungsten Carbide Inserts with Sternal Needles and Wire up to 18 Gauge	6 in 152 mm
32-123	Tungsten Carbide Inserts	7¼ in 184 mm



32-122



Scan the code above to learn more about our Laparoscopic portfolio.

Laparoscopic Portfolio



symmetry surgical™

Laparoscopic



New Products	LAP-2
Accessories & Miscellaneous	LAP-22
Cables	LAP-31
Dissectors	LAP-32
MultiPak	LAP-32
ScopePak	LAP-32
Symmetry Surgical Laparoscopic Instruments	LAP-33
Symmetry Surgical RapidClean® Instruments	LAP-75
Symmetry Ultra™ Kleppinger Type Bipolar Forceps	LAP-90
Electrodes	LAP-92
Sterilization Solutions	LAP-94

Questions? Contact us at customerservice@symmetrysurgical.com or learn more at symmetrysurgical.com



The Surgical Instrument Desk Reference

How to Use Our Catalog

The Symmetry Surgical catalog is designed with you in mind, to be your trusted resource for surgical instrumentation. We took great care in creating an easy-to-use, robust catalog and we think you'll be pleased with the design as you become more familiar with our broad portfolio.

Layout

The catalog is organized by surgical specialty *and* product function.

And we know that it is difficult to pick up an instrument and know what specialty it's listed in. To make your job easier, we've sorted the instruments in our portfolio by surgical function, too, including Energy, Laparoscopic, Retractors and Sterilization Solutions.

U.S. Customer Service

Your Symmetry Surgical Customer Service team wants to make ordering surgical instruments the easiest part of your day. We accept orders via phone, fax, email, our website, Global Healthcare Exchange (GHX) and through the mail.

PHONE

1.800.251.3000

(Available Monday through Friday, 8:30 AM–6:30 PM EST)

FAX

1.800.342.3272

EMAIL

customerservice@symmetrysurgical.com

ONLINE

symmetrysurgical.com

MAILING ADDRESS

Symmetry Surgical
Attn: Customer Service
3034 Owen Drive
Antioch, TN 37013

The Surgical Instrument Desk Reference

International Customer Service

PHONE

Symmetry Surgical Switzerland GmbH
+41 (0) 52 557 59 00
(Available Monday through Friday, 7:00-16:00 GMT)

Symmetry Surgical, Inc., USA
1.615.964.5672
(Available Monday through Friday, 8:30 AM–6:30 PM EST)

FAX

Symmetry Surgical Switzerland GmbH
+41 (0) 52 557 59 99

EMAIL

customerservice@symmetrysurgical.com
internationalorders@symmetrysurgical.com

ONLINE

symmetrysurgical.com

MAILING ADDRESS

Symmetry Surgical Switzerland GmbH
Bühlstrasse 27
CH-8200 Schaffhausen
Switzerland

Symmetry Surgical, Inc.
3034 Owen Drive
Antioch, TN 37013

INTERNATIONAL PAYMENT TERMS/RETURN GOODS POLICY/INSTRUMENT REPAIR & RESTORE PROGRAM/LITERATURE REQUESTS

Please contact your local distributor. Locate a local distributor contact, International Customer Service at +41 (0) 52 557 59 00 or 1.615.964.5672 (US).

Cardiovascular/Thoracic

Energy

Ear, Nose & Throat

General

Laparoscopic

Neurology

Obesity

OB/GYN

Ophthalmology

Orthopedics & Arthroscopy

Pediatrics

Rectal

Retractors

Spine

Urology

Sterilization Solutions

Alphabetical & Numeric Indexes

New Products

RapidClean® Glide Lock Instruments



RapidClean® Glide Lock Devices (Complete Device)

CODE	DESCRIPTION	DIAMETER	TIP SIZE	LENGTH
99-21302	5 mm Traumatic Grasper, 2x3 Teeth, Insert, Handle & Lumen, Standard Length (99-11302 & 99-00000)	5 mm	22 mm	37 mm
99-21302L	5 mm Traumatic Grasper, 2x3 Teeth, Insert, Handle & Lumen, Opti-Length® (99-11302L & 99-00000L)	5 mm	22 mm	49 mm
99-21323	5 mm Dorsey Fenestrated Grasper Insert, Handle & Lumen, Standard Length (99-11323 & 99-00000)	5 mm	30 mm	38 mm
99-21323L	5 mm Dorsey Fenestrated Grasper Insert, Handle & Lumen, Opti-Length® (99-11323L & 99-00000L)	5 mm	30 mm	49 mm
99-21333	5 mm Atraumatic Grasper Insert, Handle & Lumen, Standard Length (99-11333 & 99-00000)	5 mm	22 mm	37 mm
99-21333L	5 mm Atraumatic Grasper Insert, Handle & Lumen, Opti-Length® (99-11333L & 99-00000L)	5 mm	22 mm	49 mm
99-21345	5 mm Single Action Traumatic Grasper, 2x3 Teeth, Insert, Handle & Lumen, Standard Length (99-11345 & 99-00000)	5 mm	22 mm	37 mm
99-21345L	5 mm Single Action Traumatic Grasper, 2x3 Teeth, Insert, Handle & Lumen, Opti-Length® (99-11345L & 99-00000L)	5 mm	22 mm	48 mm
99-21346	5 mm Atraumatic Grasper Single Action Insert, Handle & Lumen, Standard Length (99-11346 & 99-00000)	5 mm	22 mm	37 mm
99-21346L	5 mm Atraumatic Grasper Single Action Insert, Handle & Lumen, Opti-Length® (99-11346L & 99-00000L)	5 mm	22 mm	48 mm
99-21364	5 mm Tenaculum Insert, Handle & Lumen, Standard Length (99-11364 & 99-00000)	5 mm	23 mm	37 mm
99-21364L	5 mm Tenaculum Insert, Handle & Lumen, Opti-Length® (99-11364L & 99-00000L)	5 mm	23 mm	49 mm
99-21369	5 mm Fenestrated Bowel Grasper Insert, Handle & Lumen, Standard Length (99-11369 & 99-00000)	5 mm	20 mm	37 mm
99-21369L	5 mm Fenestrated Bowel Grasper Insert, Handle & Lumen, Opti-Length® (99-11369L & 99-00000L)	5 mm	20 mm	48 mm

New Products

RapidClean® Glide Lock Instruments

Replacement Handle & Lumen Assemblies for RapidClean® Glide Lock

CODE	DESCRIPTION	DIAMETER	TIP SIZE
99-00000	5 mm Take-Apart Glide Lock Handle & Tube Assembly, Standard Length	5 mm	28 mm
99-00000L	5 mm Take-Apart Glide Lock Handle & Tube Assembly, Opti-Length®	5 mm	28 mm



99-11302

Replacement Insert Assemblies for RapidClean® Glide Lock

CODE	DESCRIPTION	DIAMETER	TIP SIZE
99-11302	5 mm Traumatic Grasper, 2x3 Teeth, Insert, Standard Length	5 mm	22 mm
99-11302L	5 mm Traumatic Grasper, 2x3 Teeth, Insert, Opti-Length®	5 mm	22 mm
99-11323	5 mm Dorsey Fenestrated Grasper Insert, Standard Length	5 mm	30 mm
99-11323L	5 mm Dorsey Fenestrated Grasper Insert, Opti-Length®	5 mm	30 mm
99-11333	5 mm Atraumatic Grasper Insert, Standard Length	5 mm	22 mm
99-11333L	5 mm Atraumatic Grasper Insert, Opti-Length®	5 mm	22 mm
99-11345	5 mm Single Action Traumatic Grasper, 2x3 Teeth, Insert, Standard Length	5 mm	22 mm
99-11345L	5 mm Single Action Traumatic Grasper, 2x3 Teeth, Insert, Opti-Length®	5 mm	22 mm
99-11346	5 mm Atraumatic Grasper Single Action Insert, Standard Length	5 mm	22 mm
99-11346L	5 mm Atraumatic Grasper Single Action Insert, Opti-Length®	5 mm	22 mm
99-11364	5 mm Tenaculum Insert, Standard Length	5 mm	23 mm
99-11364L	5 mm Tenaculum Insert, Opti-Length®	5 mm	23 mm
99-11369	5 mm Fenestrated Bowel Grasper Insert, Standard Length	5 mm	20 mm
99-11369L	5 mm Fenestrated Bowel Grasper Insert, Opti-Length®	5 mm	20 mm

New Products

Symmetry Surgical Laparoscopic Instruments

Single Piece Laparoscopic Instruments are available with multiple handle configurations.



Monopolar Handle



Monopolar Handle with Rotation



Standard Handle



Standard Handle with Rotation



Auto Closure Handle



Auto Closure Handle with Rotation



Ratcheting Handle



Ratcheting Handle with Rotation



Slide Lock Handle



Slide Lock Handle with Rotation



5mm Allis Forcep

CODE	DESCRIPTION	DIAMETER	TIP SIZE	LENGTH
98-1111	Monopolar Handle	5 mm	12 mm	33 mm
98-1112	Monopolar Handle with Rotation	5 mm	12 mm	35 mm
98-1113	Ratcheting Handle	5 mm	12 mm	33 mm
98-1114	Ratcheting Handle with Rotation	5 mm	12 mm	35 mm
98-114L	Ractheting Handle with Rotation Opti-Length®, 45	5 mm	12 mm	45 mm

New Products

Symmetry Surgical Laparoscopic Instruments



5mm Long Allis Forcep

CODE	DESCRIPTION	DIAMETER	TIP SIZE	LENGTH
98-1115	Monopolar Handle with Rotation	5 mm	28 mm	37 mm
98-1116	Ratcheting Handle with Rotation	5 mm	28 mm	37 mm
98-1117	Slide Lock Handle with Rotation	5 mm	28 mm	37 mm
98-1118	Standard Handle with Rotation	5 mm	28 mm	37 mm



5mm Traumatic Grasper with 2x3 Teeth

CODE	DESCRIPTION	DIAMETER	TIP SIZE	LENGTH
98-1119	Auto Closure Handle with Rotation	5 mm	22 mm	36 mm
98-1120	Ratcheting Handle with Rotation	5 mm	22 mm	36 mm
95-1048SL-DA	Slide Lock Handle	5 mm	22 mm	36 mm
95-1048SL-DA-ROT	Slide Lock Handle with Rotation	5 mm	22 mm	36 mm
98-1121L	Slide Lock Handle with Rotation Opti-Length®, 45	5 mm	22 mm	45 mm
98-1122	Standard Handle with Rotation	5 mm	22 mm	36 mm



5mm Glassman Forcep

CODE	DESCRIPTION	DIAMETER	TIP SIZE	LENGTH
98-1123	Monopolar Handle with Rotation	5 mm	40 mm	38 mm
98-1124	Ratcheting Handle	5 mm	40 mm	36 mm
98-1125	Ratcheting Handle with Rotation	5 mm	40 mm	38 mm
98-1125L	Ratcheting Handle with Rotation Opti-Length®, 45	5 mm	40 mm	47 mm
98-1126	Standard Handle	5 mm	40 mm	36 mm
98-1127	Slide Lock Handle with Rotation	5 mm	40 mm	38 mm
98-1127L	Slide Lock Handle with Rotation Opti-Length®, 45	5 mm	40 mm	47 mm
98-1128	Standard Handle with Rotation	5 mm	40 mm	38 mm
98-1128L	Standard Handle with Rotation Opti-Length®, 45	5 mm	40 mm	47 mm

New Products

Symmetry Surgical Laparoscopic Instruments



5mm Mckernan Tri-Grasping Fenestrated Forcep

CODE	DESCRIPTION	DIAMETER	TIP SIZE	LENGTH
98-1129	Ratcheting Handle	5 mm	21 mm	34 mm
98-1130	Ratcheting Handle with Rotation	5 mm	21 mm	36 mm
98-1130L	Ratcheting Handle with Rotation Opti-Length®, 45	5 mm	21 mm	45 mm
98-1131	Slide Lock Handle with Rotation	5 mm	21 mm	36 mm
98-1132	Standard Handle with Rotation	5 mm	21 mm	36 mm



5mm Alligator Forcep

CODE	DESCRIPTION	DIAMETER	TIP SIZE	LENGTH
98-1133	Monopolar Handle	5 mm	13 mm	36 mm
90-1072	Ratcheting Handle	5 mm	13 mm	36 mm
90-1072L	Monopolar Handle Opti-Length®, 45	5 mm	13 mm	44 mm
98-1134	Ratcheting Handle with Rotation	5 mm	13 mm	35 mm



5mm Pointed Dissector with Cup

CODE	DESCRIPTION	DIAMETER	TIP SIZE	LENGTH
90-1033	Monopolar Handle	5 mm	12 mm	35 mm
90-1033E	Monopolar Handle Opti-Length®, 45	5 mm	12 mm	44 mm
98-1135	Monopolar Handle with Rotation	5 mm	12 mm	35 mm
98-1136	Standard Handle with Rotation	5 mm	12 mm	35 mm



5mm Curved Dissecting Forcep

CODE	DESCRIPTION	DIAMETER	TIP SIZE	LENGTH
98-1137	Monopolar Handle	5 mm	19 mm	36 mm
98-1138	Monopolar Handle with Rotation	5 mm	19 mm	36 mm
98-1139	Standard Handle with Rotation	5 mm	19 mm	36 mm

New Products

Symmetry Surgical Laparoscopic Instruments



5mm Short Curved Dissector

CODE	DESCRIPTION	DIAMETER	TIP SIZE	LENGTH
98-1140	Monopolar Handle	5 mm	13 mm	33 mm
98-1141	Monopolar Handle with Rotation	5 mm	13 mm	35 mm



5mm Mixer Dissector

CODE	DESCRIPTION	DIAMETER	TIP SIZE	LENGTH
98-1142	Monopolar Handle	5 mm	19 mm	33 mm
98-1143	Monopolar Handle with Rotation	5 mm	19 mm	36 mm
98-1144	Standard Handle with Rotation	5 mm	19 mm	36 mm



5mm Mini Right Angle Dissector

CODE	DESCRIPTION	DIAMETER	TIP SIZE	LENGTH
98-1145	Auto Closure Handle with Rotation	5 mm	12 mm	35 mm
98-1146	Monopolar Handle with Rotation	5 mm	12 mm	35 mm
98-1146L	Monopolar Handle with Rotation Opti-Length®, 45	5 mm	12 mm	44 mm
98-1147	Ratcheting Handle with Rotation	5 mm	12 mm	35 mm
98-1148	Slide Lock Handle	5 mm	12 mm	35 mm
98-1149	Slide Lock Handle with Rotation	5 mm	12 mm	35 mm
98-1150	Standard Handle with Rotation	5 mm	12 mm	35 mm
98-1150L	Standard Handle with Rotation Opti-Length®, 45	5 mm	12 mm	44 mm



5mm Micro Dolphin Dissecting Forcep

CODE	DESCRIPTION	DIAMETER	TIP SIZE	LENGTH
98-1151	Monopolar Handle	5 mm	11 mm	33 mm
98-1152	Monopolar Handle with Rotation	5 mm	11 mm	35 mm

New Products

Symmetry Surgical Laparoscopic Instruments



5mm Claw Forcep with 2x3 Teeth

CODE	DESCRIPTION	DIAMETER	TIP SIZE	LENGTH
90-1005	Auto Closure Handle	5 mm	22 mm	34 mm
98-1153	Ratcheting Handle	5 mm	22 mm	34 mm
98-1154	Ratcheting Handle with Rotation	5 mm	22 mm	36 mm
98-1154L	Slide Lock Handle with Rotation, 45	5 mm	22 mm	36 mm
98-1155	Slide Lock Handle with Rotation	5 mm	22 mm	36 mm



5mm Biopsy Forcep with Two Teeth

CODE	DESCRIPTION	DIAMETER	TIP SIZE	LENGTH
98-1156	Auto Closure Handle	5 mm	11 mm	33 mm
90-1071	Monopolar Handle	5 mm	11 mm	33 mm
90-1071L	Monopolar Handle Opti-Length®, 45	5 mm	11 mm	44 mm



5mm Dorsey Fenestrated Grasper

CODE	DESCRIPTION	DIAMETER	TIP SIZE	LENGTH
97-1031RC	Ratcheting Handle with Rotation	5 mm	30 mm	37 mm
97-1031RCL	Ratcheting Handle with Rotation Opti-Length®, 45	5 mm	30 mm	46 mm
95-1031SL	Slide Lock Handle Opti-Length®, 45	5 mm	30 mm	46 mm
98-1157	Slide Lock Handle with Rotation	5 mm	30 mm	37 mm
98-1157L	Slide Lock with Rotation Opti-Length®, 45	5 mm	30 mm	46 mm
98-1158	Standard Handle with Rotation	5 mm	30 mm	37 mm

New Products

Symmetry Surgical Laparoscopic Instruments



5mm Endo Babcock Forcep

CODE	DESCRIPTION	DIAMETER	TIP SIZE	LENGTH
98-1159	Monopolar Handle with Rotation	5 mm	29 mm	37 mm
97-1089RC	Ratcheting Handle with Rotation	5 mm	29 mm	37 mm
98-1160	Slide Lock Handle with Rotation	5 mm	29 mm	37 mm
98-1161	Standard Handle with Rotation	5 mm	29 mm	37 mm



5mm DeBakey Tissue Forcep

CODE	DESCRIPTION	DIAMETER	TIP SIZE	LENGTH
98-1162	Monopolar Handle with Rotation	5 mm	38 mm	38 mm
98-1163L	Ratcheting Handle Opti-Length®, 45	5 mm	38 mm	45 mm
98-1164	Ratcheting Handle with Rotation	5 mm	38 mm	38 mm
98-1164L	Ratcheting Handle with Rotation Opti-Length®, 45	5 mm	38 mm	45 mm
98-1165	Standard Handle	5 mm	38 mm	35 mm
98-1165L	Standard Handle Opti-Length®, 45	5 mm	38 mm	45 mm
98-1166	Slide Lock Handle with Rotation	5 mm	38 mm	38 mm
98-1167L	Standard Handle with Rotation Opti-Length®, 45	5 mm	38 mm	45 mm



5mm Grasping Forcep

CODE	DESCRIPTION	DIAMETER	TIP SIZE	LENGTH
98-1168	Auto Closure Handle with Rotation	5 mm	13 mm	35 mm
98-1169	Monopolar Handle	5 mm	13 mm	33 mm
98-1170	Monopolar Handle with Rotation	5 mm	13 mm	35 mm
98-1170L	Monopolar Handle with Rotation, 45	5 mm	13 mm	35 mm
98-1171	Ratcheting Handle	5 mm	13 mm	33 mm
98-1172	Ratcheting Handle with Rotation	5 mm	13 mm	35 mm
98-1172L	Ratcheting Handle with Rotation, 45	5 mm	13 mm	35 mm
98-1173	Standard Handle	5 mm	13 mm	33 mm
98-1174	Slide Lock Handle with Rotation	5 mm	13 mm	35 mm
98-1175	Standard Handle with Rotation	5 mm	13 mm	35 mm

New Products

Symmetry Surgical Laparoscopic Instruments



5mm Fenestrated Grasping Forcep

CODE	DESCRIPTION	DIAMETER	TIP SIZE	LENGTH
98-1176	Monopolar Handle with Rotation	5 mm	22 mm	36 mm
98-1177	Ratcheting Handle with Rotation	5 mm	22 mm	36 mm
98-1178	Slide Lock Handle with Rotation	5 mm	22 mm	36 mm



5mm Micro Dissecting Forcep

CODE	DESCRIPTION	DIAMETER	TIP SIZE	LENGTH
90-1044	Monopolar Handle	5 mm	13 mm	33 mm
90-1044L	Monopolar Handle Opti-Length®, 45	5 mm	13 mm	45 mm
97-1042RC	Monopolar Handle with Rotation	5 mm	13 mm	35 mm
98-1179	Ratcheting Handle with Rotation	5 mm	13 mm	35 mm



5mm Babcock Grasping Forcep

CODE	DESCRIPTION	DIAMETER	TIP SIZE	LENGTH
98-1180	Monopolar Handle with Rotation	5 mm	25 mm	37 mm
98-1181	Ratcheting Handle	5 mm	25 mm	34 mm
98-1182	Ratcheting Handle with Rotation	5 mm	25 mm	37 mm
98-1183	Slide Lock Handle with Rotation	5 mm	25 mm	37 mm



5mm Dolphin Nose Dissecting Forcep with Cup

CODE	DESCRIPTION	DIAMETER	TIP SIZE	LENGTH
90-1030	Monopolar Handle	5 mm	16 mm	36 mm
90-1030L	Monopolar Handle Opti-Length®, 45	5 mm	16 mm	45 mm
97-1030RC	Monopolar Handle with Rotation	5 mm	16 mm	36 mm

New Products

Symmetry Surgical Laparoscopic Instruments



5mm Cobra Jaw Grasping Forcep

CODE	DESCRIPTION	DIAMETER	TIP SIZE	LENGTH
98-1184	Ratcheting Handle	5 mm	16 mm	33 mm
90-1069	Ratcheting Handle	5 mm	13 mm	35 mm
90-1069RL	Ratcheting Handle with Rotation Opti-Length®, 45	5 mm	13 mm	45 mm

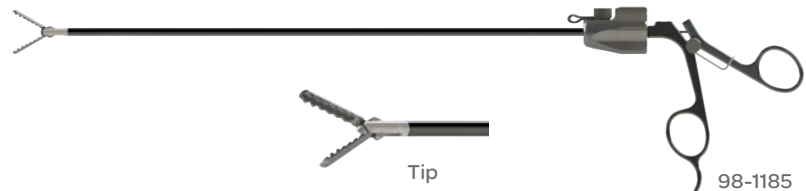

5mm Atraumatic Grasper (Double Action)

CODE	DESCRIPTION	DIAMETER	TIP SIZE	LENGTH
98-1185	Auto Closure Handle with Rotation	5 mm	22 mm	36 mm
98-1186	Monopolar Handle with Rotation	5 mm	22 mm	36 mm
98-1186L	Monopolar Handle with Rotation Opti-Length®, 45	5 mm	22 mm	45 mm
98-1187	Ratcheting Handle	5 mm	22 mm	34 mm
98-1188	Ratcheting Handle with Rotation	5 mm	22 mm	36 mm
98-1188L	Ratcheting Handle with Rotation Opti-Length®, 45	5 mm	22 mm	45 mm
98-1189	Slide Lock Handle	5 mm	22 mm	34 mm
95-1049SL-DA-45	Slide Lock Handle Opti-Length®, 45	5 mm	22 mm	46 mm
95-1049SL-DA-ROT	Slide Lock Handle with Rotation	5 mm	22 mm	36 mm
98-1109L	Slide Lock Handle with Rotation Opti-Length®, 45	5 mm	22 mm	45 mm
98-1191	Standard Handle with Rotation	5 mm	22 mm	36 mm
98-1191L	Standard Handle with Rotation Opti-Length®, 45	5 mm	22 mm	45 mm



5mm Paddle Babcock

CODE	DESCRIPTION	DIAMETER	TIP SIZE	LENGTH
98-1192	Ratcheting Handle with Rotation	5 mm	29 mm	37 mm
98-1193	Standard Handle with Rotation	5 mm	29 mm	37 mm
98-1194	Monopolar Handle with Rotation	5 mm	29 mm	37 mm
98-1195	Slide Lock Handle with Rotation	5 mm	29 mm	37 mm

New Products

Symmetry Surgical Laparoscopic Instruments



5mm Tri-Grasper

CODE	DESCRIPTION	DIAMETER	TIP SIZE	LENGTH
90-1050	Ratcheting Handle	5 mm	16 mm	33 mm
90-1050L	Ratcheting Handle Opti-Length®, 45	5 mm	16 mm	45 mm
97-1050RC	Ratcheting Handle with Rotation	5 mm	16 mm	36 mm
95-1050SL-DA-ROT	Slide Lock Handle with Rotation	5 mm	16 mm	36 mm
95-1050SL-DA-ROT-45	Slide Lock with Rotation Opti-Length®, 45	5 mm	16 mm	45 mm
98-1196	Standard Handle with Rotation	5 mm	16 mm	36 mm



5mm Long Grasping Forcep

CODE	DESCRIPTION	DIAMETER	TIP SIZE	LENGTH
98-1197	Auto Closure Handle with Rotation	5 mm	19 mm	36 mm
98-1198	Monopolar Handle with Rotation	5 mm	19 mm	36 mm
98-1198L	Monopolar Handle with Rotation, 45	5 mm	19 mm	36 mm
98-1199	Ratcheting Handle with Rotation	5 mm	19 mm	36 mm
98-1199L	Ratcheting Handle with Rotation, 45	5 mm	19 mm	36 mm
98-1200	Slide Lock Handle with Rotation	5 mm	19 mm	36 mm
98-1201	Standard Handle with Rotation	5 mm	19 mm	36 mm



5mm Maxi Fenestrated Grasper

CODE	DESCRIPTION	DIAMETER	TIP SIZE	LENGTH
98-1202	Monopolar Handle with Rotation	5 mm	18 mm	36 mm
98-1203	Ratcheting Handle	5 mm	18 mm	35 mm
98-1204	Ratcheting Handle with Rotation	5 mm	18 mm	36 mm
98-1204L	Ratcheting Handle with Rotation Opti-Length®, 45	5 mm	18 mm	45 mm
98-1205	Slide Lock Handle with Rotation	5 mm	18 mm	36 mm

New Products

Symmetry Surgical Laparoscopic Instruments



5mm Retrograde Grasping Forcep

CODE	DESCRIPTION	DIAMETER	TIP SIZE	LENGTH
98-1206	Ratcheting Handle	5 mm	13 mm	33 mm
98-1207	Ratcheting Handle with Rotation	5 mm	13 mm	35 mm
98-1208	Slide Lock Handle with Rotation	5 mm	13 mm	35 mm



5mm Kocher Grasping Forcep

CODE	DESCRIPTION	DIAMETER	TIP SIZE	LENGTH
98-1209	Auto Closure Handle with Rotation	5 mm	13 mm	35 mm
98-1210	Ratcheting Handle with Rotation	5 mm	13 mm	35 mm
98-1211	Ratcheting Handle	5 mm	13 mm	35 mm
98-1212	Standard Handle with Rotation	5 mm	13 mm	35 mm



5mm Curved Maryland Dissector

CODE	DESCRIPTION	DIAMETER	TIP SIZE	LENGTH
90-1067	Monopolar Handle	5 mm	23 mm	34 mm
90-1067-L	Monopolar Handle Opti-Length®, 45	5 mm	23 mm	45 mm
97-1067RC	Monopolar Handle with Rotation	5 mm	23 mm	36 mm
98-1286L	Monopolar Handle with Rotation, 45	5 mm	23 mm	36 mm
95-1067SL-ROT-45	Slide Lock Handle with Rotation Opti-Length®, 45	5 mm	23 mm	45 mm
98-1200	Slide Lock Handle with Rotation	5 mm	23 mm	36 mm

New Products

Symmetry Surgical Laparoscopic Instruments



5mm Dolphin Nose Dissecting Forcep with Cup

CODE	DESCRIPTION	DIAMETER	TIP SIZE	LENGTH
98-1213	Monopolar Handle with Rotation	5 mm	13 mm	35 mm
98-1214	Ratcheting Handle with Rotation	5 mm	13 mm	35 mm
98-1215	Slide Lock Handle with Rotation	5 mm	13 mm	35 mm
98-1216	Standard Handle with Rotation	5 mm	13 mm	35 mm



5mm Single Action Traumatic Grasper

CODE	DESCRIPTION	DIAMETER	TIP SIZE	LENGTH
97-1056RC	Ratcheting Handle with Rotation	5 mm	22 mm	36 mm
95-1048SL	Slide Lock Handle	5 mm	22 mm	36 mm
95-1048SL-45	Slide Lock Handle Opti-Length®, 45	5 mm	22 mm	45 mm
98-1217	Slide Lock Handle with Rotation	5 mm	22 mm	36 mm
98-1217L	Slide Lock Handle with Rotation Opti-Length®, 45	5 mm	22 mm	45 mm



5mm Single Action Atraumatic Grasper

CODE	DESCRIPTION	DIAMETER	TIP SIZE	LENGTH
97-1051RC	Ratcheting Handle with Rotation	5 mm	22 mm	36 mm
98-1218L	Ratcheting Handle with Rotation Opti-Length®, 45	5 mm	22 mm	45 mm
95-1049SL	Slide Lock Handle	5 mm	22 mm	37 mm
95-1049SL-45	Slide Lock Handle Opti-Length®, 45	5 mm	22 mm	45 mm
95-1049SL-ROT	Slide Lock Handle with Rotation	5 mm	22 mm	36 mm
95-1049SL-ROT-45	Slide Lock Handle with Rotation Opti-Length®, 45	5 mm	22 mm	45 mm
98-1220	Standard Handle with Rotation	5 mm	22mm	36 mm

New Products

Symmetry Surgical Laparoscopic Instruments



5mm Grasping Forcep with Cup

CODE	DESCRIPTION	DIAMETER	TIP SIZE	LENGTH
98-1221	Auto Closure Handle with Rotation	5 mm	12 mm	35 mm
90-1035	Monopolar Handle	5 mm	12 mm	33 mm
90-1035L	Monopolar Handle OptiLength, 45	5 mm	12 mm	45 mm
97-1035RC	Monopolar Handle with Rotation	5 mm	12 mm	35 mm
98-1222L	Monopolar Handle with Rotation Opti-Length®, 45	5 mm	12 mm	44 mm
97-1055RC	Ratcheting Handle with Rotation	5 mm	12 mm	35 mm
98-1223L	Ratcheting Handle with Rotation Opti-Length®	5 mm	12 mm	44 mm
98-1224	Slide Lock Handle with Rotation	5 mm	12 mm	35 mm
98-1225	Standard Handle with Rotation	5 mm	12 mm	35 mm
98-1225L	Standard Handle with Rotation Opti-Length®, 45	5 mm	12 mm	44 mm



5mm Ripple Claw Forcep

CODE	DESCRIPTION	DIAMETER	TIP SIZE	LENGTH
98-1226	Ratcheting Handle with Rotation	5 mm	23 mm	36 cm
98-1227	Slide Lock Handle	5 mm	23 mm	34 cm
98-1228	Slide Lock Handle with Rotation	5 mm	23 mm	36 cm



5mm Mini-Micro Dissecting Forcep

CODE	DESCRIPTION	DIAMETER	TIP SIZE	LENGTH
98-1229	Monopolar Handle	5 mm	12 mm	35 cm
98-1230	Monopolar Handle with Rotation	5 mm	12 mm	35 cm
98-1231	Standard Handle with Rotation	5 mm	12 mm	35 cm

New Products

Symmetry Surgical Laparoscopic Instruments



5mm Flat Dissector

CODE	DESCRIPTION	DIAMETER	TIP SIZE	LENGTH
90-1040	Monopolar Handle	5 mm	13 mm	35 cm
90-1040L	Monopolar Handle, Opti-Length®	5 mm	13 mm	45 cm



5mm Biopsy Scoop Forcep

CODE	DESCRIPTION	DIAMETER	TIP SIZE	LENGTH
90-1075	Monopolar Handle	5 mm	13 mm	35 cm
90-1075L	Monopolar Handle, Opti-Length®	5 mm	13 mm	45 cm



5mm Tenaculum

CODE	DESCRIPTION	DIAMETER	TIP SIZE	LENGTH
98-1232	Auto Closure Handle	5 mm	23 mm	34 cm
98-1232L	Auto Closure Handle, Opti-Length®	5 mm	23 mm	45 cm
98-1233	Auto Closure Handle with Rotation	5 mm	23 mm	36 cm
98-1234	Monopolar Handle with Rotation	5 mm	23 mm	36 cm
98-1235	Ratcheting Handle	5 mm	23 mm	36 cm
98-1236	Ratcheting Handle with Rotation	5 mm	23 mm	36 cm
98-1236L	Ratcheting Handle with Rotation, Opti-Length®	5 mm	23 mm	45 cm
98-1237	Slide Lock Handle	5 mm	23 mm	36 cm
98-1238	Slide Lock Handle with Rotation	5 mm	23 mm	36 cm
98-1238L	Slide Lock Handle with Rotation, Opti-Length®	5 mm	23 mm	45 cm
98-1239	Standard Handle with Rotation	5 mm	23 mm	36 cm

New Products

Symmetry Surgical Laparoscopic Instruments



5mm Medium Curved Dissector

CODE	DESCRIPTION	DIAMETER	TIP SIZE	LENGTH
98-1240	Monopolar Handle with Rotation	5 mm	17 mm	36 cm
98-1240L	Monopolar Handle with Rotation, Opti-Length®	5 mm	17 mm	45 cm



Fenestrated Bowel Grasper, 5mm

CODE	DESCRIPTION	DIAMETER	TIP SIZE	LENGTH
98-1241	Monopolar Handle with Rotation	5 mm	20 mm	36 cm
98-1241L	Monopolar Handle with Rotation, Opti-Length®	5 mm	20 mm	45 cm
98-1242	Ratcheting Handle	5 mm	20 mm	36 cm
98-1243	Ratcheting Handle with Rotation	5 mm	20 mm	36 cm
98-1244	Slide Lock Handle with Rotation	5 mm	20 mm	36 cm
98-1244L	Slide Lock handle with Rotation, Opti-Length®	5 mm	20 mm	45 cm
98-1245	Standard Handle with Rotation	5 mm	20 mm	36 cm
98-1245L	Standard Handle with Rotation, Opti-Length®	5 mm	20 mm	45 cm



5mm Curved DeBakey Tissue Forcep

CODE	DESCRIPTION	DIAMETER	TIP SIZE	LENGTH
98-1246	Monopolar Handle with Rotation	5 mm	27 mm	37 cm
98-1247	Ratcheting Handle with Rotation	5 mm	27 mm	37 cm
98-1248	Slide Lock Handle with Rotation	5 mm	27 mm	37 cm
98-1249	Standard Handle with Rotation	5 mm	27 mm	37 cm

New Products

Symmetry Surgical Laparoscopic Instruments



5mm Andrew Babcock Forcep

CODE	DESCRIPTION	DIAMETER	TIP SIZE	LENGTH
98-1250	Monopolar Handle with Rotation	5 mm	19 mm	36 cm
98-1251	Ratcheting Handle with Rotation	5 mm	19 mm	36 cm
94-1089SL	Slide Lock Handle	5 mm	19 mm	36 cm
98-1252	Slide Lock Handle with Rotation	5 mm	19 mm	36 cm
98-1252L	Slide Lock Handle with Rotation, Opti-Length®	5 mm	19 mm	45 cm



5mm Maryland with Cross Serrations

CODE	DESCRIPTION	DIAMETER	TIP SIZE	LENGTH
98-1253	Monopolar Handle with Rotation	5 mm	19 mm	36 cm
98-1253L	Monopolar Handle with Rotation, Opti-Length®	5 mm	19 mm	45 cm
98-1254	Ratcheting Handle	5 mm	19 mm	36 cm



Murray Grasper, 5mm

CODE	DESCRIPTION	DIAMETER	TIP SIZE	LENGTH
98-1255	Ratcheting Handle	5 mm	11 mm	35 cm
97-1078RC	Ratcheting Handle with Rotation	5 mm	11 mm	35 cm
98-1256	Slide Lock Handle with Rotation	5 mm	11 mm	35 cm

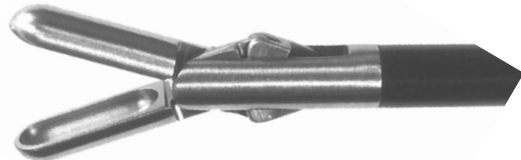

5mm Double Action Spoon Forcep

CODE	DESCRIPTION	DIAMETER	TIP SIZE	LENGTH
98-1257	Standard Handle	5 mm	13 mm	36 cm
98-1258	Standard Handle with Rotation	5 mm	13 mm	35 cm
98-1258L	Standard Handle with Rotation, Opti-Length®	5 mm	13 mm	44 cm

New Products

Symmetry Surgical Laparoscopic Instruments

5mm Meah Grasper



CODE	DESCRIPTION	DIAMETER	TIP SIZE	LENGTH
98-1259	Ratcheting Handle with Rotation	5 mm	21 mm	36 cm
98-1260	Slide Lock Handle with Rotation	5 mm	21 mm	36 cm
98-1260L	Slide Lock Handle with Rotation, Opti-Length®	5 mm	21 mm	45 cm

10mm Angled Circle Grasper

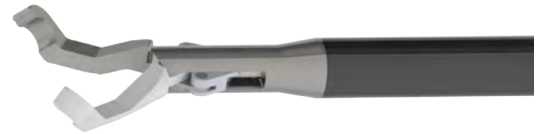

CODE	DESCRIPTION	DIAMETER	TIP SIZE	LENGTH
98-1261	Ratcheting Handle with Rotation	10 mm	24 mm	36 cm
98-1261L	Ratcheting Handle with Rotation, Opti-Length®	10 mm	24 mm	45 cm

10mm Glassman



CODE	DESCRIPTION	DIAMETER	TIP SIZE	LENGTH
98-1262	Ratcheting Handle with Rotation	10 mm	60 mm	37 cm
98-1262L	Ratcheting Handle with Rotation, Opti-Length®	10 mm	60 mm	45 cm

10mm Right Angle Dissector



CODE	DESCRIPTION	DIAMETER	TIP SIZE	LENGTH
98-1263	Ratcheting Handle	10 mm	37 mm	37 cm
98-1264	Standard Handle	10 mm	37 mm	37 cm
98-1265	Standard Handle with Rotation	10 mm	37 mm	37 cm

New Products

Symmetry Surgical Laparoscopic Instruments



10mm Mixer Dissector

CODE	DESCRIPTION	DIAMETER	TIP SIZE	LENGTH
98-1266	Standard Handle	10 mm	27 mm	37 cm
98-1267	Standard Handle with Rotation	10 mm	27 mm	37 cm



Claw Forcep, 10mm

CODE	DESCRIPTION	DIAMETER	TIP SIZE	LENGTH
90-1015	Auto Closure Handle	10 mm	29 mm	35 cm
98-1268L	Auto Closure Handle, Opti-Length®	10 mm	29 mm	45 cm
98-1269	Ratcheting Handle	10 mm	29 mm	35 cm
98-1270	Ratcheting Handle with Rotation	10 mm	29 mm	35 cm
98-1270L	Ratcheting Handle with Rotation, Opti-Length®	10 mm	29 mm	45 cm
98-1271	Standard Handle	10 mm	29 mm	35 cm
98-1272	Standard Handle with Rotation	10 mm	29 mm	35 cm



10mm Spoon Forcep

CODE	DESCRIPTION	DIAMETER	TIP SIZE	LENGTH
98-1273	Auto Closure Handle	10 mm	25 mm	35 cm
98-1274	Auto Closure Handle with Rotation	10 mm	25 mm	35 cm
98-1273L	Auto Closure Handle, Opti-Length®	10 mm	25 mm	45 cm
90-1070	Ratcheting Handle	10 mm	25 mm	35 cm
90-1070L	Ratcheting Handle, Opti-Length®	10 mm	25 mm	45 cm
98-1275	Ratcheting Handle with Rotation	10 mm	25 mm	35 cm
98-1276	Standard Handle	10 mm	25 mm	35 cm
98-1277	Standard Handle with Rotation	10 mm	25 mm	35 cm
98-1277L	Standard Handle with Rotation, Opti-Length®	10 mm	25 mm	45 cm

New Products

Symmetry Surgical Laparoscopic Instruments



10mm Babcock, Short Jaw

CODE	DESCRIPTION	DIAMETER	TIP SIZE	LENGTH
98-1278	Auto Closure with Rotation	10 mm	25 mm	35 cm
97-1083RC	Ratcheting Handle with Rotation	10 mm	25 mm	35 cm



10mm Babcock with Straight Serrations

CODE	DESCRIPTION	DIAMETER	TIP SIZE	LENGTH
97-1097RC	Ratchet Handle with Rotation	10 mm	35 mm	37 cm
98-1288L	Ratchet Handle with Rotation, Opti-Length®	10 mm	35 mm	45 cm



10mm Paddle Babcock

CODE	DESCRIPTION	DIAMETER	TIP SIZE	LENGTH
98-1279	Ratchet Handle with Rotation	10 mm	35 mm	37 cm
98-1280L	Ratchet Handle with Rotation, Opti-Length®	10 mm	35 mm	45 cm



10mm Tenaculum

CODE	DESCRIPTION	DIAMETER	TIP SIZE	LENGTH
98-1281	Auto Closure Handle	10 mm	36 mm	38 cm
98-1282	Auto Closure Handle with Rotation	10 mm	36 mm	38 cm
98-1283	Ratcheting Handle	10 mm	36 mm	38 cm
98-1284	Ratcheting Handle with Rotation	10 mm	36 mm	38 cm
98-1284L	Ratcheting Handle with Rotation, Opti-Length®	10 mm	36 mm	45 cm
98-1285	Standard Handle with Rotation	10 mm	36 mm	38 cm

Accessories & Miscellaneous



Fan Retractor

CODE	DESCRIPTION	DIAMETER	JAW SIZE	LENGTH
24-1800	Pressure Lock Handle	10 mm	60 mm	24 cm
32-1800	Pressure Lock Handle	10 mm	60 mm	32 cm
38-1800	Pressure Lock Handle	10 mm	60 mm	38 cm
45-1800	Pressure Lock Handle	10 mm	60 mm	45 cm
24-1800R	Ratchet Lock Handle	10 mm	60 mm	24 cm
32-1800R	Ratchet Lock Handle	10 mm	60 mm	32 cm
38-1800R	Ratchet Lock Handle	10 mm	60 mm	38 cm
45-1800R	Ratchet Lock Handle	10 mm	60 mm	45 cm



Bariatric Hook

CODE	DESCRIPTION	DIAMETER	LENGTH
2010101	In-Line Handle	5 mm	45 cm



Bariatric Knot Pusher

CODE	DESCRIPTION	DIAMETER	LENGTH
2010201	In-Line Handle	10 mm	45 cm

Accessories & Miscellaneous

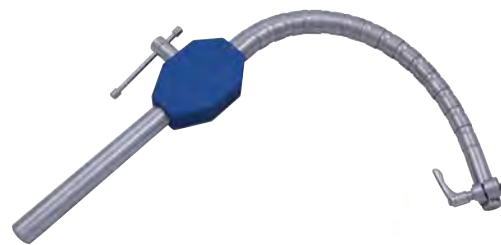

504805

Bookwalter® Universal Flex Arm System

Bookwalter® Table Post and Bookwalter® Coupler Required - Not Included

CODE	DESCRIPTION
50-4805	Universal Flex Arm System (Includes Flex Arm and 1 Each of the 4 Adapters)
50-4806	Ring Adapter for Universal Flex Arm
50-4807	Lap Instrument Adapter for Universal Flex Arm
50-4808	Camera Lens Adapter for Universal Flex Arm
50-4809	Camera Lens Adapter for Universal Flex Arm

Bookwalter® Laparoscopic Support Set

CODE	DESCRIPTION	QTY
50-5730	Laparoscopic Support Set Includes the Following:	
50-4683	Bookwalter® Table Post, 8 in	1
50-4554	Bookwalter® Post Coupling	1
50-4805	Bookwalter® Universal Flex Arm, Includes 4 Adapters Listed Below	1
50-4806	Bookwalter® Flex Arm Ring Adapter	1
50-4607	Bookwalter® Flex Arm Laparoscopic Instrument Adapter	1
50-4608	Bookwalter® Flex Arm Camera Lens Adapter	1
50-4609	Bookwalter® Flex Arm Camera Housing Adapter	1
68-1593	Fan Retractor, 5mm, Articulating, 3 Fingers	1
68-1594	Fan Retractor, 10mm, Articulating, 5 Fingers	1

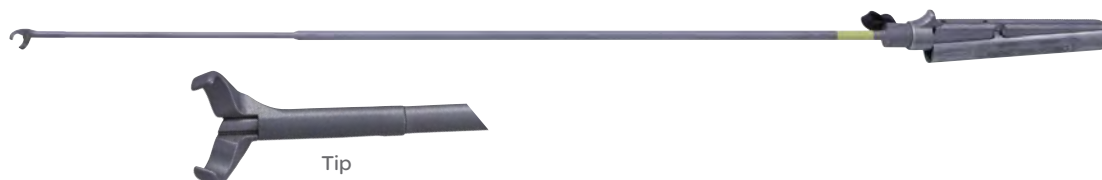

Nathanson Flex Arm

Holds 5 mm and 10 mm Instruments, For Use with Bookwalter® Table Post and Bookwalter® Coupler

CODE	DESCRIPTION
SPO1115-45	Flex Arm

Accessories & Miscellaneous

Circular Anvil Grasper

CODE	DESCRIPTION	DIAMETER	LENGTH
2010202	In-Line Handle	10 mm	45 cm



Tip

38-5411

Dodd Knot Pusher

CODE	DESCRIPTION	LENGTH
38-5401	0-Suture	38 cm
38-5411	2-0 Suture	38 cm



Fan Retractors

To Be Used with the Universal Flex Arm on LAP-23

CODE	DESCRIPTION	DIAMETER
681590	Fan Liver Retractor, Three Fingers	5 mm
681593	Fan Liver Retractor, Articulating, Three Fingers	5 mm
681591	Fan Liver Retractor, Articulating, Five Fingers	10 mm
681594	Fan Liver Retractor, Articulating, Five Fingers	10 mm



Tip

Gastric Band Passer

CODE	DESCRIPTION	DIAMETER	LENGTH
2010301	In-Line Handle	15 mm	45 cm

Accessories & Miscellaneous



32-5397

Handle

To Be Used with 12 Series Reposable Scissors

CODE	DESCRIPTION	DIAMETER
32-5399	Reposable, Monopolar, Non-Locking with Metzenbaum Tip	32 cm
32-5397	Reposable, Monopolar, Non-Locking	32 cm
38-5397	Reposable, Monopolar, Non-Locking	38 cm



90-6004

Hasson "S" Retractor

Set of 2

CODE	WIDTH		DIAMETER	LENGTH
90-6003	¼ in	6.35 mm	6 in	152.4 mm
90-6004	½ in	12.7 mm	6 in	152.4 mm
90-6005	¾ in	10 mm	7 ½ in	180 mm
90-6006	⅝ in	15 mm	7 ½ in	180 mm
90-6007	¾ in	19 mm	7 ½ in	180 mm

TIP
12-5383

Hook Reposable Scissors

For Use with Reposable Handles 32-5397 and 38-5397

CODE	DESCRIPTION	TIP SIZE	DIAMETER	LENGTH
12-5383	Monopolar, Non-Locking	8 mm	5 mm	32 cm
12-5393	Monopolar, Non-Locking	8 mm	5 mm	38 cm

Accessories & Miscellaneous

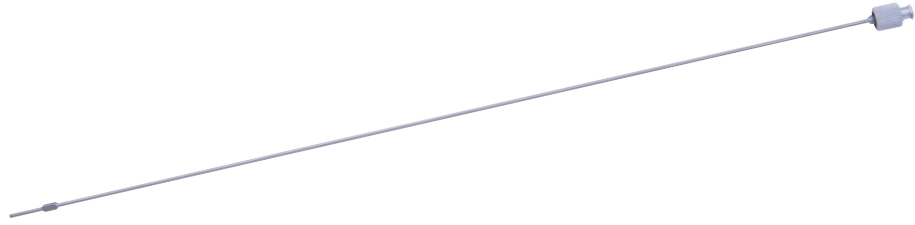

Irrigating/Aspirating Cannula

CODE	DESCRIPTION
90-5070	Dual Valve



Luer Lock Cap

CODE	DESCRIPTION
90-0000	Choli, 10/Pack



TIP
12-5382

Metzenbaum Reposable Scissors

For Use with Reposable Handles 32-5397, 32-5399 and 38-5397

CODE	DESCRIPTION	DIAMETER	TIP SIZE	QTY
12-5382	Curved, 45° Opening	5 mm	11 mm	5/Pack
12-5392	Curved, 45° Opening	5 mm	11 mm	
12-5384	Curved, Delicate, 45° Opening	5 mm	11 mm	5/Pack
12-5394	Curved, Delicate, 45° Opening	5 mm	11 mm	

Accessories & Miscellaneous



Myoma Screw

CODE	DESCRIPTION	DIAMETER	LENGTH
90-5600	Screw	5 mm	32 cm
90-5605	Screw	5 mm	45 cm

Nathanson Retractor Hooks

CODE	DESCRIPTION	DIAMETER	DIMENSIONS
52420-00	Kit includes One Small, One Medium, One Large	6.5 mm	
52420-01	Small	6.5 mm	3 ½ x 7 x 4 ½ in 89 x 178 x 114 mm
52420-02	Medium	6.5 mm	4 ½ x 8 ½ x 8 in 114 x 216 x 203 mm
52420-03	Large	6.5 mm	6 ½ x 11 x 10 in 165 x 279 x 254 mm

90-5600



Reducer Sleeve

CODE	SIZE
90-5030	5-4 mm

Reusable Scissors

Use with Reusable Handle 32-5399

TIP
12-5391

CODE	DESCRIPTION	DIAMETER	TIP SIZE
12-5391	Curved, Single, 45° Opening	5 mm	8 mm

Accessories & Miscellaneous



Roeder Loop Applicator

CODE	DESCRIPTION	DIAMETER	LENGTH
91-0630	Loop Applicator	5 mm	15 cm



Tip
29-5403

Saye/Reddick Knot Pusher

CODE	DESCRIPTION	LENGTH
29-5403	Closed	29 cm
38-5403	Closed	38 cm
38-5402	Opened	38 cm



Tip

38-5506

Saye/Reddick Needle Holder

Pressure Lock Handle, with Flush Port

CODE	DESCRIPTION	DIAMETER	JAW SIZE	LENGTH
38-5505	Straight, Double-Action	5 mm	11 mm	38 cm
38-5506	Straight, Single-Action	5 mm	11 mm	38 cm
45-5506	Straight, Single-Action	5 mm	11 mm	45 cm
24-5507	Curved, Single-Action	5 mm	11 mm	24 cm
32-5507	Curved, Single-Action	5 mm	11 mm	32 cm
38-5507	Curved, Single-Action	5 mm	11 mm	38 cm

Accessories & Miscellaneous

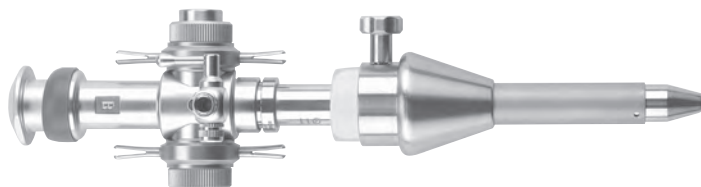

Trocars

Hasson Open Cannula

CODE	DESCRIPTION	DIAMETER
90-9101	With Suture Tying Posts	11 mm
90-9102	With Suture Tying Posts	10 mm



Ultra™ Ergonomic Needle Holder

CODE	DESCRIPTION	DIAMETER	LENGTH
90-3035	Ring Handle In-Line with Shaft, Ratchet Handle, Single-Action	5 mm	32 cm



Ultra™ Knot Pusher

CODE	DESCRIPTION	DIAMETER	LENGTH
90-5099	Opened	5 mm	32 cm

Accessories & Miscellaneous

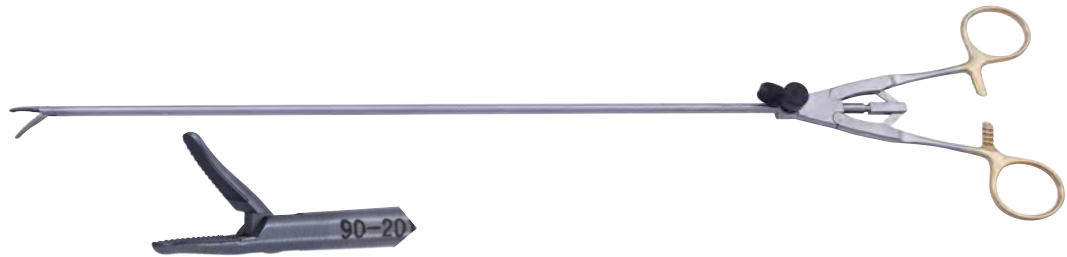

Ultra™ Needle Holder

Axial Handle

CODE	DESCRIPTION	DIAMETER	LENGTH
90-2011	Needle Holder, Curved Left, Tungsten Carbide	5 mm	35 cm



90-5053

Ultra™ Palpation Probe

CODE	DESCRIPTION	DIAMETER	LENGTH
90-5053	With Centimeter Graduations	5 mm	32 cm
90-5053L	With Centimeter Graduations	5 mm	45 cm



90-5049

Ultra™ Puncture Needle with Aspiration

Puncture Needle Aspirator

CODE	DESCRIPTION	DIAMETER	LENGTH
90-5048	10 Gauge	5 mm	32 cm
90-5049	12 Gauge	5 mm	32 cm
90-5051	15 Gauge	5 mm	32 cm
90-5050	19 Gauge	5 mm	32 cm
90-5052	22 Gauge	5 mm	32 cm
90-5051L	15 Gauge	5 mm	45 cm
90-5050L	19 Gauge	5 mm	45 cm
90-5052L	22 Gauge	5 mm	45 cm

Accessories & Miscellaneous



Tip

90-3038

Ultra™ Tungsten Carbide Needle Holder

Flush Port, Squeeze Handle with Ratchet

CODE	DESCRIPTION	DIAMETER	LENGTH
90-3039	Straight	5 mm	32 cm
90-3038	Curved	5 mm	32 cm
90-3038L	Curved	5 mm	45 cm



90-5054

Verres Needle

CODE	DESCRIPTION	DIAMETER	LENGTH
90-5058	Needle	2 mm	7.5 cm
90-5054	Needle	2 mm	10 cm
90-5055	Needle	2 mm	12.5 cm
90-5059	Needle	2 mm	20 cm

Cables



90-1020

Reusable Bipolar Cable

CODE	DESCRIPTION	LENGTH
90-1020	For Symmetry/Wolf Kleppinger Type Forceps and Wolf Generator	10 ft
90-1021	For Symmetry/Wolf Kleppinger Forceps and Birtcher, Cabot and Valley Lab Type Generator	10 ft

Dissectors

Secto® Laparoscopic Dissectors

5 mm x 400 mm Stick, 10 per box



CODE	DESCRIPTION
81-1003	Secto® Cherry Laparoscopic Dissector, 10 mm Cherry Sponge Spun Cotton Tip
81-1004	Secto® Bullet Laparoscopic Dissector, 5 mm Bullet Sponge Spun Cotton Tip
81-1005	Secto® Kittner Laparoscopic Dissector, ¼ in x ⅝ in Kittner Sponge Dissector Tip, Hand-Sewn Cotton Chevron Tape Roll

MultiPak

MultiPak Accessories

ITEM	CODE	DESCRIPTION	SIZE
	5200	Endoscopic Silicone Bar Holder, for Wire Rack 5100-5113, 7113	7 in 177 mm
	5200N	Endoscopic Silicone Bar Holder, for Wire Rack 5108 or 5109	6.5 in 165 mm

*Silicone accessories include plastic holding bar and screws; excluding 5310

ScopePak

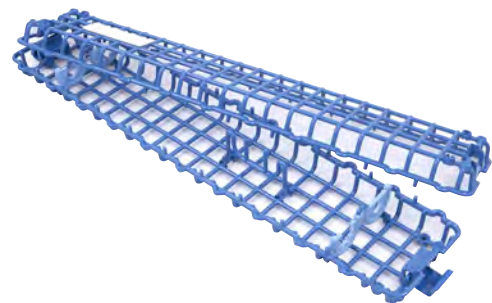

ScopePak Cases

CODE	DESCRIPTION	DIMENSIONS (INTERNAL)
9417-1	OnePak, 17 in, Configured to Accommodate 1 Scope	3 ⅙ x 1 ⅞ x 1 ½ in 82.5 x 43 x 38 mm

ScopePak



ScopePak Base & Lid Only

9321-00

CODE	DESCRIPTION	DIMENSIONS (INTERNAL)	
9312-00	Small Base and Lid	3 x 11 $\frac{1}{10}$ x 1 $\frac{3}{10}$ in	76 x 282 x 33 mm
9317-00	Medium Base and Lid	3 x 16 x 1 $\frac{3}{10}$ in	76 x 406 x 33 mm
9321-00	Large Base and Lid	3 x 20 x 1 $\frac{3}{10}$ in	76 x 508 x 33 mm
9326-00	Extra-Large Base and Lid	4 x 26 x 2 $\frac{4}{5}$ in	102 x 660 x 71 mm
9331-00	Long Base and Lid	4 $\frac{7}{10}$ x 30 $\frac{3}{10}$ x 2 $\frac{4}{5}$ in	119 x 769 x 71 mm

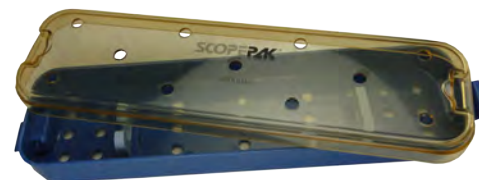

ScopePak Base & Lid with Scope Holder Sets

9312

CODE	DESCRIPTION	INCLUDES	DIMENSIONS (INTERNAL)	
9312	Small Base and Lid	2/Each 5350 1/Each 5351	3 x 11 $\frac{1}{10}$ x 1 $\frac{3}{10}$ in	76 x 282 x 33 mm
9317	Medium Base and Lid	4/Each 5353 2/Each 5352	3 x 16 x 1 $\frac{3}{10}$ in	76 x 406 x 33 mm
9321	Large Base and Lid	2/Each 5350 1/Each 5351	3 x 20 x 1 $\frac{3}{10}$ in	76 x 508 x 33 mm
9326	Extra-Large Base and Lid	1/Each 5350 1/Each 5351	4 x 26 x 2 $\frac{4}{5}$ in	102 x 660 x 71 mm
9331	Long Base and Lid	4/Each 5353 2/Each 5352	4 $\frac{7}{10}$ x 30 $\frac{3}{10}$ x 2 $\frac{4}{5}$ in	119 x 769 x 71 mm

Symmetry Surgical Laparoscopic Instruments

FEATURE: PUSH DRIVE ACTUATION

Patented link mechanism eliminates the need for wings at the distal tip, while allowing for strong tactile feedback.

- Flushport to Assist in Cleaning
- Internal One-Way Seal helps prevent bio burden from flowing back up the inner lumens
- Ergonomic Handle Design for comfortable fit with precise control
- Laparoscopic Instruments Available In 45 cm Length
- Made in the USA

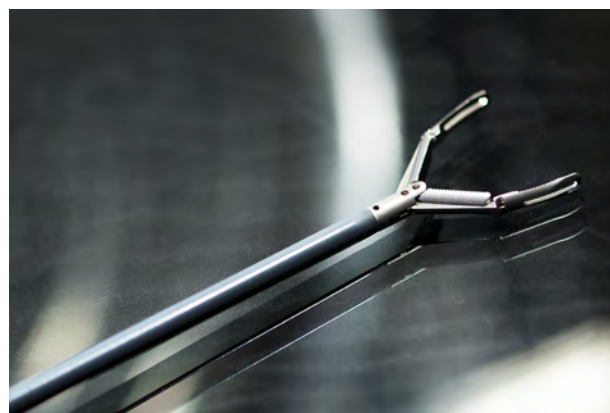

Symmetry Surgical Laparoscopic Instruments



Aggressive Retention Grasping Forceps

60° Opening

32-5101

CODE	DESCRIPTION	DIAMETER	TIP SIZE	LENGTH
32-5101	Pressure Lock Monopolar Handle	5 mm	15 mm	32 cm
38-5101	Pressure Lock Monopolar Handle	5 mm	15 mm	38 cm
32-5101R	Ratchet Lock Handle	5 mm	15 mm	32 cm
38-5101R	Ratchet Lock Handle	5 mm	15 mm	38 cm



Allis Grasping Forceps

60° Opening

32-5103

CODE	DESCRIPTION	DIAMETER	TIP SIZE	LENGTH
32-5103	Pressure Lock Handle	5 mm	18 mm	32 cm
38-5103	Pressure Lock Handle	5 mm	18 mm	38 cm
38-5103R	Ratchet Lock Handle	5 mm	18 mm	38 cm

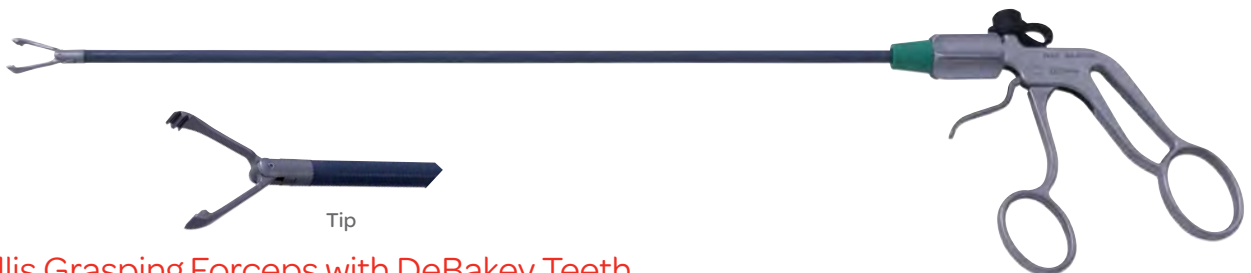

Allis Grasping Forceps with DeBakey Teeth

60° Opening

32-5110

CODE	DESCRIPTION	DIAMETER	TIP SIZE	LENGTH
24-5110	Pressure Lock Handle	5 mm	18 mm	24 cm
32-5110	Pressure Lock Handle	5 mm	18 mm	32 cm

Symmetry Surgical Laparoscopic Instruments



32-5117

Atraumatic Fenestrated Grasping Forceps

CODE	DESCRIPTION	DIAMETER	TIP SIZE	LENGTH
32-5117	Pressure Lock, Monopolar Handle, 60° Opening	5 mm	20 mm	32 cm
38-5117	Pressure Lock, Monopolar Handle, 60° Opening	5 mm	20 mm	38 cm



24-5157

Atraumatic Fenestrated Parallel Jaw Grasping Forceps

For Enhanced Grasping Power without the Need for Excessive Closing Force

CODE	DESCRIPTION	DIAMETER	TIP SIZE	LENGTH
24-5157	Pressure Lock Handle	5 mm	16 mm	24 cm
32-5157	Pressure Lock Handle	5 mm	16 mm	32 cm
38-5157	Pressure Lock Handle	5 mm	16 mm	38 cm
45-5157	Pressure Lock Handle	5 mm	16 mm	45 cm
24-5158	Pressure Lock Handle	5 mm	25 mm	24 cm
32-5158	Pressure Lock Handle	5 mm	25 mm	32 cm
38-5158	Pressure Lock Handle	5 mm	25 mm	38 cm
45-5158	Pressure Lock Handle	5 mm	25 mm	45 cm
24-5157R	Ratchet Lock Handle	5 mm	16 mm	24 cm
38-5157R	Ratchet Lock Handle	5 mm	16 mm	38 cm
45-5157R	Ratchet Lock Handle	5 mm	16 mm	45 cm
24-5158R	Ratchet Lock Handle	5 mm	25 mm	24 cm
32-5158R	Ratchet Lock Handle	5 mm	25 mm	32 cm
38-5158R	Ratchet Lock Handle	5 mm	25 mm	38 cm
45-5158R	Ratchet Lock Handle	5 mm	25 mm	45 cm

Symmetry Surgical Laparoscopic Instruments

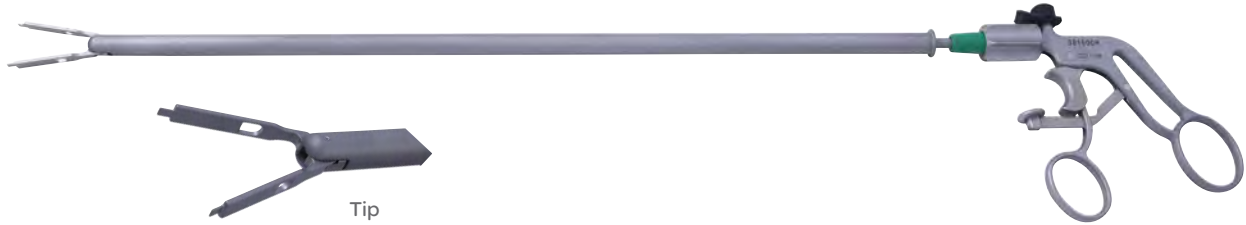

Atraumatic Grasping Forceps

CODE	DESCRIPTION	DIAMETER	LENGTH
38-1600R	Grasper Locking Handle	10 mm	38 cm



Babcock Grasping Forceps

60° Opening

24-5104

CODE	DESCRIPTION	DIAMETER	TIP SIZE	LENGTH
24-5104	Pressure Lock Handle	5 mm	18 mm	24 cm
32-5104	Pressure Lock Handle	5 mm	18 mm	32 cm
38-5104	Pressure Lock Handle	5 mm	18 mm	38 cm
45-5104	Pressure Lock Handle	5 mm	18 mm	45 cm

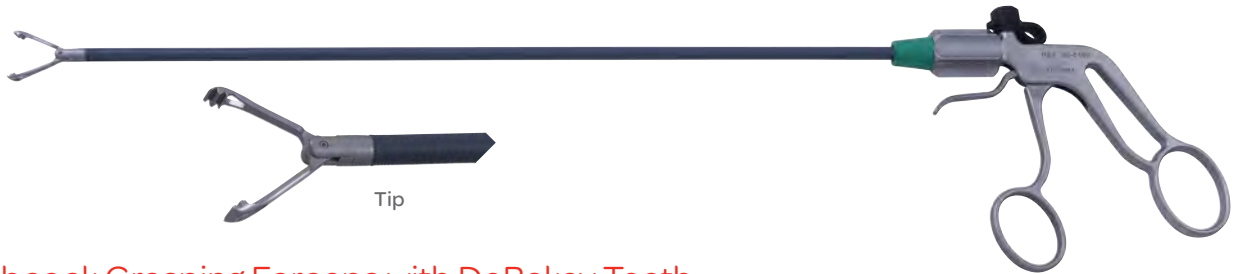

Babcock Grasping Forceps with DeBakey Teeth

60° Opening

32-5109

CODE	DESCRIPTION	DIAMETER	TIP SIZE	LENGTH
32-5109	Pressure Lock Handle	5 mm	18 mm	32 cm
32-1003	Pressure Lock Handle	5 mm	23 mm	32 cm
32-5109R	Ratchet Lock Handle	5 mm	18 mm	32 cm
32-1003R	Ratchet Lock Handle	5 mm	23 mm	38 cm
38-5109R	Ratchet Lock Handle	5 mm	18 mm	38 cm
38-1003R	Ratchet Lock Handle	5 mm	23 mm	38 cm

Symmetry Surgical Laparoscopic Instruments

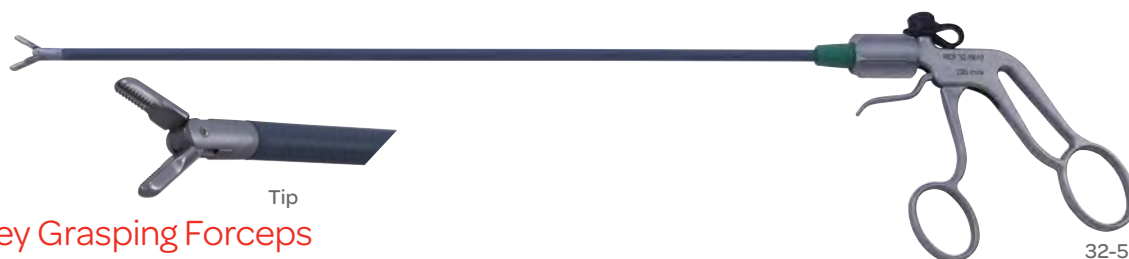

DeBakey Grasping Forceps

CODE	DESCRIPTION	DIAMETER	TIP SIZE	LENGTH
32-5610	Pressure Lock Handle	5 mm	10 mm	32 cm
45-5610	Pressure Lock Handle	5 mm	10 mm	45 cm
24-5620	Pressure Lock Handle	5 mm	20 mm	24 cm
32-5620	Pressure Lock Handle	5 mm	20 mm	32 cm
24-5640	Pressure Lock Handle	5 mm	40 mm	24 cm
32-5640	Pressure Lock Handle	5 mm	40 mm	32 cm
38-5640	Pressure Lock Handle	5 mm	40 mm	38 cm
45-5640	Pressure Lock Handle	5 mm	40 mm	45 cm
38-5640R	Ratchet Lock Handle	5 mm	10 mm	38 cm
45-5610R	Ratchet Lock Handle	5 mm	10 mm	45 cm
38-5620R	Ratchet Lock Handle	5 mm	20 mm	38 cm



Dissecting Forceps, Left

Non-Locking, Monopolar Handle, 90° Opening

CODE	DIAMETER	TIP SIZE	LENGTH
245201	5 mm	11 mm	24 cm
32-5201	5 mm	11 mm	32 cm
38-5201	5 mm	11 mm	38 cm



Dissecting Forceps, Soft Left

Non-Locking, Monopolar Handle, 90° Opening

CODE	DIAMETER	TIP SIZE	LENGTH
24-5202A	5 mm	18 mm	24 cm
32-5202	5 mm	18 mm	32 cm
38-5202	5 mm	18 mm	38 cm

Symmetry Surgical Laparoscopic Instruments



38-5205

Dissecting Forceps, Snub Nose

Non-Locking, Monopolar Handle, 90° Opening

CODE	DIAMETER	TIP SIZE	LENGTH
24-5205	5 mm	11 mm	24 cm
32-5205	5 mm	11 mm	32 cm
38-5205	5 mm	11 mm	38 cm



24-5200

Dissecting Forceps, Straight

Non-Locking, Monopolar Handle

CODE	DIAMETER	TIP SIZE	LENGTH
24-5200	5 mm	13 mm	24 cm
32-5200	5 mm	13 mm	32 cm
38-5200	5 mm	13 mm	38 cm



Tip

32-5203

Dissecting Forceps, Tapered

Non-Locking, Monopolar Handle, 90° Opening

CODE	DIAMETER	TIP SIZE	LENGTH
24-5203A	5 mm	15 mm	24 cm
32-5203	5 mm	15 mm	32 cm

Symmetry Surgical Laparoscopic Instruments



Duckbill Dissecting Forceps

Monopolar Handle, 90° Opening

CODE	DESCRIPTION	DIAMETER	TIP SIZE	LENGTH
32-5204	Non-Locking Handle	5 mm	11 mm	32 cm



Duval Lung Forceps

With DeBakey Teeth, 60° Opening

24-1500

CODE	DESCRIPTION	DIAMETER	TIP SIZE	LENGTH
24-1500	Pressure Lock Handle	10 mm	53 mm	24 cm
32-1500	Pressure Lock Handle	10 mm	53 mm	32 cm

Gemini Dissecting Forceps

Monopolar Handle, 90° Opening



CODE	DESCRIPTION	DIAMETER	TIP SIZE	LENGTH
32-1206	Non-Locking Handle	10 mm	18 mm	32 cm

Symmetry Surgical Laparoscopic Instruments

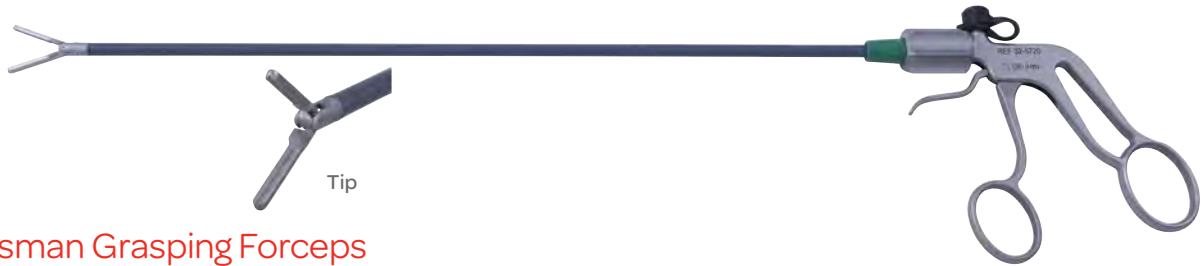

Glassman Grasping Forceps

60° Opening

CODE	DESCRIPTION	DIAMETER	TIP SIZE	LENGTH
32-5720	Pressure Lock Handle	5 mm	20 mm	32 cm



Grasping Forceps

CODE	DESCRIPTION	DIAMETER	TIP SIZE	LENGTH
32-5207	Non-Locking, Monopolar Handle, Tapered	5 mm	15 mm	32 cm



Grasping Forceps

CODE	DESCRIPTION	DIAMETER	TIP SIZE	LENGTH
32-5108	Pressure Lock, Monopolar Handle, Short Nose, 60° Opening	5 mm	11 mm	32 cm
32-5108R	Ratchet Lock Handle, Short Nose, 60° Opening	5 mm	11 mm	32 cm
38-5108R	Ratchet Lock Handle, Short Nose, 60° Opening	5 mm	11 mm	38 cm

Symmetry Surgical Laparoscopic Instruments



32-5107R

Grasping Forceps

CODE	DESCRIPTION	DIAMETER	TIP SIZE	LENGTH
32-5107	Pressure Lock, Monopolar Handle, Fenestrated	5 mm	18 mm	32 cm
38-5107	Pressure Lock, Monopolar Handle, Fenestrated	5 mm	18 mm	38 cm
32-5107R	Ratchet Handle, Fenestrated	5 mm	18 mm	32 cm



32-1001

Grasping & Extracting Forceps

2x3 Teeth

CODE	DESCRIPTION	DIAMETER	TIP SIZE	LENGTH
32-1001	Pressure Lock Handle	10 mm	27 mm	32 cm
38-1001	Pressure Lock Handle	10 mm	27 mm	38 cm
32-1001R	Ratchet Handle	10 mm	27 mm	32 cm
32-5001R	Ratchet Lock Handle	5 mm	27 mm	32 cm
38-5001R	Ratchet Lock Handle	5 mm	27 mm	38 cm



32-5303

Hook Scissors

Single-Action, 45° Opening

CODE	DESCRIPTION	DIAMETER	TIP SIZE	LENGTH
32-5303	Non-Locking, Monopolar Handle	5 mm	9 mm	32 cm
38-5303	Non-Locking, Monopolar Handle	5 mm	9 mm	38 cm
45-5303	Non-Locking, Monopolar Handle	5 mm	9 mm	45 cm

Symmetry Surgical Laparoscopic Instruments



24-5302

Metzenbaum Scissors, Curved

Monopolar Handle, 45° Opening

CODE	DESCRIPTION	DIAMETER	TIP SIZE	LENGTH
24-5302	Non-Locking Handle	5 mm	11 mm	24 cm
32-5302	Non-Locking Handle	5 mm	11 mm	32 cm
38-5302	Non-Locking Handle	5 mm	11 mm	38 cm
45-5302	Non-Locking Handle	5 mm	11 mm	45 cm
32-5304	Non-Locking Handle, Delicate	5 mm	11 mm	32 cm
38-5304	Non-Locking Handle, Delicate	5 mm	11 mm	38 cm



Retention Grasping Aggressive Forceps

CODE	DESCRIPTION	DIAMETER	TIP SIZE	LENGTH
32-5106	Pressure Lock, Monopolar Handle, Tapered, 60° Opening	5 mm	15 mm	32 cm



24-5100

Retention Grasping Forceps

CODE	DESCRIPTION	DIAMETER	TIP SIZE	LENGTH
24-5100	Pressure Lock, Monopolar Handle	5 mm	15 mm	24 cm
27-5100	Pressure Lock, Monopolar Handle	5 mm	15 mm	27 cm
32-5100	Pressure Lock, Monopolar Handle	5 mm	15 mm	32 cm
32-5100R	Ratchet Lock Handle	5 mm	15 mm	32 cm
38-5100R	Ratchet Lock Handle	5 mm	15 mm	38 cm

Symmetry Surgical Laparoscopic Instruments



Scissors

Single-Action

38-5300

CODE	DESCRIPTION	DIAMETER	TIP SIZE	LENGTH
32-5300	Straight, Non-Locking, Monopolar Handle	5 mm	8 mm	32 cm
38-5300	Straight, Non-Locking, Monopolar Handle	5 mm	8 mm	38 cm
24-5301	Curved, Non-Locking, Monopolar Handle	5 mm	8 mm	24 cm
32-5301	Curved, Non-Locking, Monopolar Handle	5 mm	8 mm	32 cm



Snake Tooth (COBRA) Grasping Forceps

CODE	DESCRIPTION	DIAMETER	TIP SIZE	LENGTH
32-5102	Pressure Lock, Monopolar Handle, 60° Opening	5 mm	15 mm	32 cm



Stone Retrieval Forceps

32-5900

CODE	DESCRIPTION	DIAMETER	TIP SIZE	LENGTH
32-5900	Non-Locking Handle, Non-Cautery	5 mm	11 mm	32 cm
32-1900	Non-Locking Handle, Non-Cautery	10 mm	27 mm	32 cm
38-5900	Non-Locking Handle, Non-Cautery	5 mm	11 mm	38 cm

Symmetry Surgical Laparoscopic Instruments



38-5209

Wave Atraumatic Grasping Forceps

CODE	DESCRIPTION	DIAMETER	LENGTH
38-5209	Pressure Lock Handle	5 mm	38 cm
45-5209	Pressure Lock Handle	5 mm	45 cm



24-5127

Wave Atraumatic Grasping Forceps

Single-Action, 45° Opening

CODE	DESCRIPTION	DIAMETER	TIP SIZE	LENGTH
24-5127	Pressure Lock, Monopolar Handle	5 mm	20 mm	24 cm
32-5127	Pressure Lock, Monopolar Handle	5 mm	20 mm	32 cm
38-5127	Pressure Lock, Monopolar Handle	5 mm	20 mm	38 cm
32-5137	Pressure Lock Handle, Long, Square Teeth	5 mm	20 mm	32 cm
32-5147	Pressure Lock Handle, Long, Square Teeth	5 mm	29 mm	32 cm
38-5127	Pressure Lock Handle	5 mm	20 mm	38 cm
38-5147	Pressure Lock Handle	5 mm	29 mm	38 cm
32-5127R	Ratchet Lock Handle	5 mm	20 mm	32 cm
32-5137R	Ratchet Lock Handle	5 mm	20 mm	32 cm
32-5147R	Ratchet Lock Handle	5 mm	29 mm	32 cm
38-5147R	Ratchet Lock Handle	5 mm	29 mm	38 cm

Symmetry Surgical Laparoscopic Instruments



Allis Tissue Grasping Forceps

CODE	DESCRIPTION	DIAMETER	LENGTH
90-1077	Ratchet Handle	10 mm	32 cm



Babcock Grasping Forceps

CODE	DESCRIPTION	DIAMETER	LENGTH
90-1079	Ratchet Handle, Double-Action	10 mm	32 cm

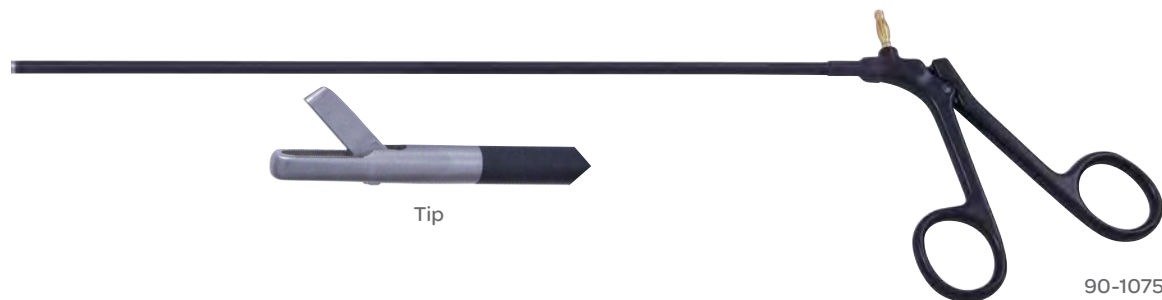

Biopsy Forceps

CODE	DESCRIPTION	DIAMETER	LENGTH
90-1075	Monopolar, Fully-Insulated, Single-Action	5 mm	32 cm
90-1075L	Monopolar, Fully-Insulated, Single-Action	5 mm	45 cm

Symmetry Surgical Laparoscopic Instruments



Bottle Nose (Dolphin Nose) Dissecting Forceps

CODE	DESCRIPTION	DIAMETER	LENGTH
90-1030	Monopolar, Fully-Insulated, Double-Action	5 mm	32 cm



Cholangiogram Forceps

CODE	DESCRIPTION	DIAMETER	LENGTH
91-5035	Ratchet Handle, Accepts Catheter Up to 7 French, Double-Action	5 mm	39 cm
90-1076	Cholangiogram Guide, Curved		32 cm

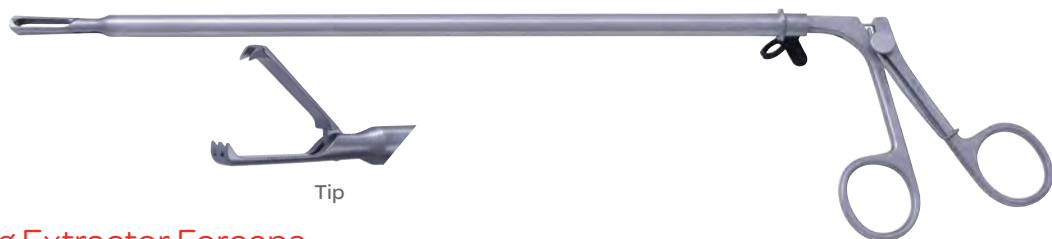

Claw Grasping Extractor Forceps

2 x 3 Heavy Teeth, Single-Action

CODE	DESCRIPTION	DIAMETER	LENGTH
90-1005	Spring Handle	5 mm	33 cm
90-1015	Spring Handle	10 mm	33 cm
90-1015L	Spring Handle	10 mm	45 cm

Symmetry Surgical Laparoscopic Instruments



Cup Tooth Dissecting Forceps

CODE	DESCRIPTION	DIAMETER	LENGTH
90-1035	Non-Locking, Monopolar, Fully-Insulated, Double-Action	5 mm	32 cm
90-1035L	Non-Locking, Monopolar, Fully-Insulated, Double-Action	5 mm	45 cm



Cup Tooth Grasping Forceps

CODE	DESCRIPTION	DIAMETER	LENGTH
90-1055	Ratchet Handle, Double-Action	5 mm	32 cm



Duckbill Dissecting Forceps

Flattened Serrated Jaw

CODE	DESCRIPTION	DIAMETER	LENGTH
90-1040	Monopolar, Fully Insulated	5 mm	32 cm

Symmetry Surgical Laparoscopic Instruments



Duval Grasping Forceps

CODE	DESCRIPTION	DIAMETER	LENGTH
90-1083	Ratchet Handle	10 mm	32 cm



Fundus Trimax Grasping Forceps

CODE	DESCRIPTION	DIAMETER	LENGTH
90-1050	Ratchet Handle, Aggressive Jaws, Double-Action	5 mm	32 cm



Hook Biopsy Forceps

CODE	DESCRIPTION	DIAMETER	LENGTH
90-1073		5 mm	33 cm

Symmetry Surgical Laparoscopic Instruments



Hook Scissors

Non-Locking

CODE	DESCRIPTION	DIAMETER	LENGTH
90-2020	Monopolar, Fully-Insulated, Single-Action	5 mm	32 cm
90-2020L	Monopolar, Fully-Insulated, Single-Action	5 mm	45 cm



Maryland Dissecting Forceps

CODE	DESCRIPTION	DIAMETER	LENGTH
90-1067	Monopolar, Fully-Insulated, Double-Action	5 mm	32 cm
90-1065	Monopolar, Fully-Insulated, Double-Action	10 mm	32 cm



Micro Fenestrated Dissecting Forceps

Fine Serrations

CODE	DESCRIPTION	DIAMETER	LENGTH
90-1044	Monopolar, Fully-Insulated	5 mm	32 cm

Symmetry Surgical Laparoscopic Instruments



Mixer Dissecting Forceps

CODE	DESCRIPTION	DIAMETER	LENGTH
90-1068	Non-Locking Handle, Monopolar, Fully Insulated	10 mm	32 cm



Pennington Grasping Forceps

CODE	DESCRIPTION	DIAMETER	LENGTH
90-1082	Ratchet Handle	10 mm	32 cm



Retrograde Grasping Forceps

CODE	DESCRIPTION	DIAMETER	LENGTH
90-1031	Ratchet Handle	5 mm	32 cm

Symmetry Surgical Laparoscopic Instruments



Grasper

CODE	DESCRIPTION	DIAMETER	LENGTH
90-2210	Insulated, Monopolar, Single-Action, Fine Tungsten Carbide Lower Blade, Serrated	5 mm	33 cm



Snake Tooth (COBRA) Grasping Forceps

CODE	DESCRIPTION	DIAMETER	LENGTH
90-1069	Ratchet Handle, 2 x 3 Teeth, Double-Action	5 mm	32 cm



Stone Retrieval Forceps

CODE	DESCRIPTION	DIAMETER	LENGTH
90-1070	Spring Handle, Single-Action	10 mm	32 cm

Symmetry Surgical Laparoscopic Instruments



Tenaculum Grasping Forceps

CODE	DESCRIPTION	DIAMETER	LENGTH
90-1008	Single Tooth, Double-Action	5 mm	32 cm



Tooth Cup Grasping Forceps

CODE	DESCRIPTION	DIAMETER	LENGTH
90-1072	Monopolar, Non-Locking	5 mm	32 cm

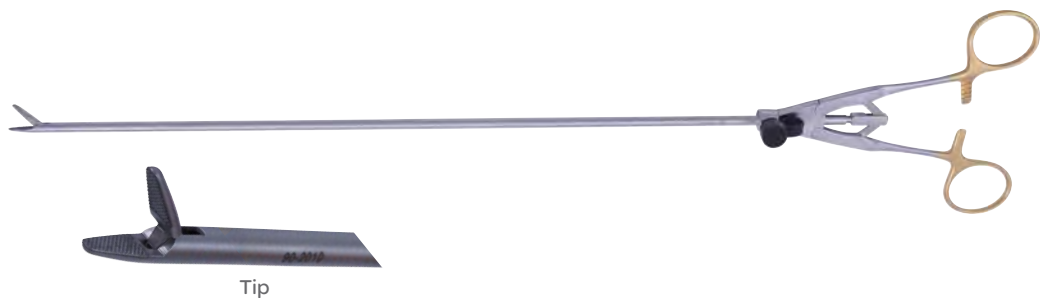

Tungsten Carbide Needle Holder

CODE	DESCRIPTION	DIAMETER	LENGTH
90-2010	Straight In-Line Handle	5 mm	35 cm

Symmetry Surgical Laparoscopic Instruments

360° rotation with flush port and Direct Drive system.
Laparoscopic instrumentation available in 45 cm length (-45).

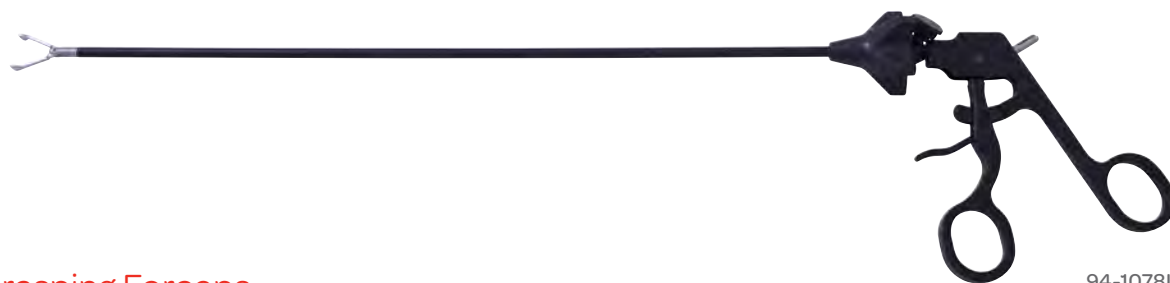

94-1078L

Allis Grasping Forceps

CODE	DESCRIPTION	DIAMETER	LENGTH
94-1078L	Direct Drive, Locking Ratchet on Demand	5 mm	33 cm
94-1078L-45	Direct Drive, Locking Ratchet on Demand	5 mm	45 cm
94-1088L	Direct Drive, Locking Ratchet on Demand	5 mm	33 cm
94-1078SL	Direct Drive, Slide Lock Handle	5 mm	33 cm
94-1078SL-45	Direct Drive, Slide Lock Handle	5 mm	45 cm



94-1053L

Atraumatic Grasping Forceps

Monopolar Handle

CODE	DESCRIPTION	DIAMETER	LENGTH
94-1053L	Direct Drive, Locking Ratchet on Demand, Double-Action	5 mm	33 cm
94-1053SL	Direct Drive, Slide Lock Handle, Double-Action	5 mm	33 cm
94-1053SL-45	Slide Lock Handle, Double-Action	5 mm	45 cm

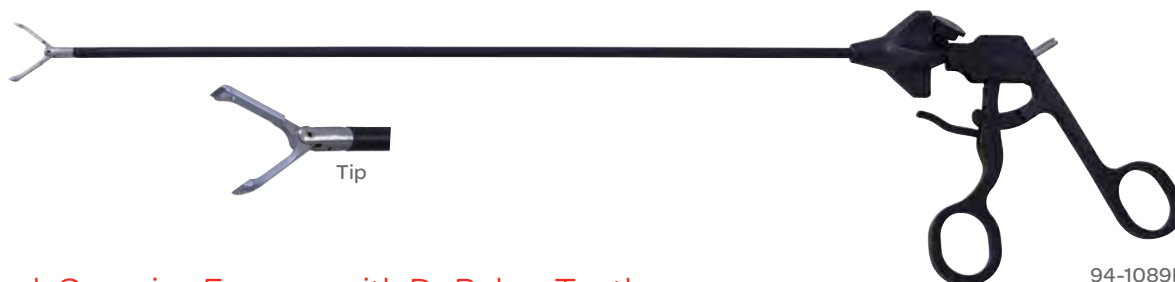

94-1089L

Babcock Grasping Forceps with DeBakey Teeth

CODE	DESCRIPTION	DIAMETER	LENGTH
94-1089L	Direct Drive, Locking Ratchet on Demand	5 mm	33 cm
94-1089SL	Direct Drive, Locking Ratchet on Demand	5 mm	33 cm

Symmetry Surgical Laparoscopic Instruments

360° rotation with flush port and Direct Drive system.
Laparoscopic instrumentation available in 45 cm length (-45).



Biopsy Punch

CODE	DESCRIPTION	DIAMETER	LENGTH
94-1075	Direct Drive, Non-Locking, Monopolar Handle	5 mm	33 cm



Bottle Nose (Dolphin Nose) Dissecting Forceps

CODE	DESCRIPTION	DIAMETER	LENGTH
94-1030	Direct Drive, Non-Locking, Double-Action	5 mm	33 cm

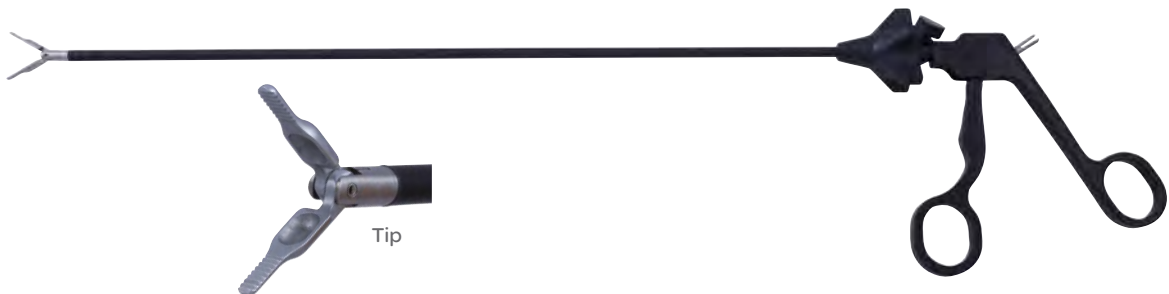

Bottle Nose (Dolphin Nose) Dissecting Forceps

CODE	DESCRIPTION	DIAMETER	LENGTH
94-1034	Direct Drive, Non-Locking, Monopolar Handle	5 mm	33 cm

Symmetry Surgical Laparoscopic Instruments

360° rotation with flush port and Direct Drive system.
Laparoscopic instrumentation available in 45 cm length (-45).



Claw Grasping Extractor Forceps

2x3 Heavy Teeth

94-1015L

CODE	DESCRIPTION	DIAMETER	LENGTH
94-1005L	Direct Drive, Locking Ratchet on Demand	5 mm	33 cm
94-1015L	Direct Drive, Locking Ratchet on Demand	10 mm	33 cm
94-1005L-45	Direct Drive, Locking Ratchet on Demand	5 mm	45 cm
94-1015L-45	Direct Drive, Locking Ratchet on Demand	10 mm	45 cm

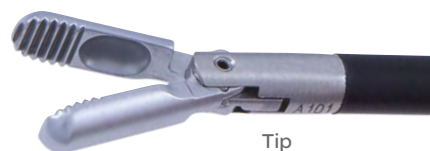

Cup Tooth Dissecting Forceps

CODE	DESCRIPTION	DIAMETER	LENGTH
94-1035	Direct Drive, Non-Locking	5 mm	33 cm



Cup Tooth Grasping Forceps

Non-Rotating

94-1035SL

CODE	DESCRIPTION	DIAMETER	JAW SIZE	LENGTH
94-1035SL	Direct Drive, Slide Lock Handle, Double-Action	5 mm	13 mm	33 cm
94-1035L	Direct Drive, Locking Ratchet on Demand	5 mm	13 mm	33 cm

Symmetry Surgical Laparoscopic Instruments

360° rotation with flush port and Direct Drive system.
Laparoscopic instrumentation available in 45 cm length (-45).



DeBakey Grasping Forceps

Non-Rotating

CODE	DESCRIPTION	DIAMETER	JAW SIZE	LENGTH
94-1091L	Direct Drive, Locking Ratchet on Demand	5 mm	20 mm	33 cm
94-1091L-45	Direct Drive, Locking Ratchet on Demand	5 mm	20 mm	45 cm
94-1091SL	Direct Drive, Slide Lock Handle	5 mm	20 mm	33 cm
94-1092SL	Direct Drive, Slide Lock Handle	5 mm	40 mm	33 cm



Dissecting Forceps

Soft Curve

CODE	DESCRIPTION	DIAMETER	LENGTH
94-1064	Direct Drive, Non-Locking, Monopolar Handle	5 mm	33 cm



Dissecting Forceps

Blunt Tip

CODE	DESCRIPTION	DIAMETER	LENGTH
94-1064	Direct Drive, Non-Locking, Monopolar Handle	5 mm	33 cm

Symmetry Surgical Laparoscopic Instruments

360° rotation with flush port and Direct Drive system.
Laparoscopic instrumentation available in 45 cm length (-45).



94-1032L

Tip

Grasping Forceps

Blunt Tip

CODE	DESCRIPTION	DIAMETER	LENGTH
94-1032L	Direct Drive, Locking Ratchet on Demand	5 mm	33 cm
94-1032L-45	Direct Drive, Locking Ratchet on Demand	5 mm	45 cm



Tip

Hook Scissors

CODE	DESCRIPTION	DIAMETER	LENGTH
94-2020	Direct Drive, Non-Locking	5 mm	33 cm



Tip

94-1093

Hunter Bowel Grasping Forceps

CODE	DESCRIPTION	DIAMETER	JAW SIZE	LENGTH
94-1093	Direct Drive, Non-Locking, Monopolar Handle	5 mm	20 mm	33 cm
94-1093-45	Direct Drive, Non-Locking, Monopolar Handle	5 mm	20 mm	45 cm
94-1093L	Direct Drive, Locking, Ratchet on Demand, Monopolar Handle	5 mm	20 mm	33 cm
94-1093L-45	Direct Drive, Locking, Ratchet on Demand, Monopolar Handle	5 mm	20 mm	45 cm

Symmetry Surgical Laparoscopic Instruments

360° rotation with flush port and Direct Drive system.
Laparoscopic instrumentation available in 45 cm length (-45).



Maryland Dissecting Forceps

Curved

CODE	DESCRIPTION	DIAMETER	LENGTH
94-1067-45	Direct Drive, Non-Locking, Monopolar Handle	5 mm	45 cm



Mixer Dissecting Forceps

Right Angle

CODE	DESCRIPTION	DIAMETER	LENGTH
94-1066	Direct Drive, Non-Locking, Monopolar Handles	5 mm	33 cm
94-1066-45	Direct Drive, Non-Locking, Monopolar Handles	5 mm	45 cm



Mixer Dissecting Forceps

CODE	DESCRIPTION	DIAMETER	LENGTH
94-1068	Direct Drive, Non-Locking	10 mm	33 cm

Symmetry Surgical Laparoscopic Instruments

360° rotation with flush port and Direct Drive system.
Laparoscopic instrumentation available in 45 cm length (-45).



Micro Fenestrated Dissecting Forceps

Fine Serration

CODE	DESCRIPTION	DIAMETER	LENGTH
94-1044	Direct Drive, Monopolar, Fully-Insulated	5 mm	33 cm



Needle Nose Dissecting Forceps

CODE	DESCRIPTION	DIAMETER	LENGTH
94-1045	Direct Drive, Non-Locking, Monopolar Handle	5 mm	33 cm



Retraction Grasping Forceps

CODE	DESCRIPTION	DIAMETER	LENGTH
94-1056L	Direct Drive, Locking Ratchet on Demand, Single-Action	5 mm	33 cm

Symmetry Surgical Laparoscopic Instruments

360° rotation with flush port and Direct Drive system.
Laparoscopic instrumentation available in 45 cm length (-45).



Slide Lock Retraction Grasping Forceps

Non-Rotating

CODE	DESCRIPTION	DIAMETER	LENGTH
94-1049SL-45	Slide Lock Handle	5 mm	45 cm



Snake Tooth (COBRA) Grasping Forceps

CODE	DESCRIPTION	DIAMETER	LENGTH
94-1069L	Direct Drive, Locking Ratchet on Demand	5 mm	33 cm



Stone Retrieval Forceps

CODE	DESCRIPTION	DIAMETER	LENGTH
95-1070	Direct Drive, Non-Locking	10 mm	33 cm

Symmetry Surgical Laparoscopic Instruments

360° rotation with flush port and Direct Drive system.
Laparoscopic instrumentation available in 45 cm length (-45).



Tip

Stone Spoon Retrieval & Grasping Forceps

CODE	DESCRIPTION	DIAMETER	LENGTH
94-1070	Direct Drive, Non-Locking	5 mm	33 cm



Tip

Scissors

Straight

CODE	DESCRIPTION	DIAMETER	LENGTH
94-2009	Direct Drive, Non-Locking	5 mm	33 cm



Tip

94-1051

Wave Atraumatic Grasping Forceps

Monopolar Handles

CODE	DESCRIPTION	DIAMETER	LENGTH
94-1051	Direct Drive, Non-Locking, Single-Action	5 mm	33 cm
94-1051-45	Direct Drive, Non-Locking, Single-Action	5 mm	45 cm
94-1051L	Direct Drive, Locking Ratchet on Demand, Single-Action	5 mm	33 cm

Symmetry Surgical Laparoscopic Instruments

360° rotation with flush port and Direct Drive system.
Laparoscopic instrumentation available in 45 cm length (-45).



Alligator Grasping Forceps

CODE	DESCRIPTION	DIAMETER	LENGTH
95-1052L	Direct Drive, Locking Ratchet on Demand	5 mm	33 cm
95-1052L-45	Direct Drive, Locking Ratchet on Demand	5 mm	45 cm

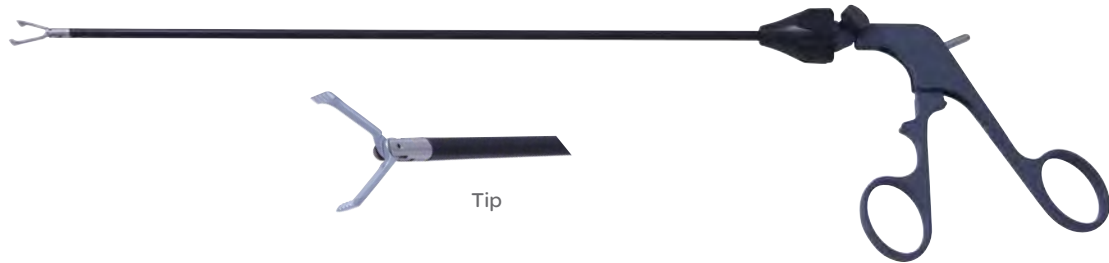

Allis Grasping Forceps

CODE	DESCRIPTION	DIAMETER	LENGTH
95-1078L	Direct Drive, Locking Ratchet on Demand	5 mm	33 cm



Babcock Grasping Forceps

CODE	DESCRIPTION	DIAMETER	LENGTH
95-1089L	Direct Drive, Locking Ratchet on Demand	5 mm	33 cm
95-1089L-45	Direct Drive, Locking Ratchet on Demand	5 mm	45 cm
95-1079L	Direct Drive, Locking Ratchet on Demand	10 mm	33 cm

Symmetry Surgical Laparoscopic Instruments

360° rotation with flush port and Direct Drive system.
Laparoscopic instrumentation available in 45 cm length (-45).



Claw Grasping Extractor Forceps

2 x 3 Heavy Teeth, Single-Action

CODE	DESCRIPTION	DIAMETER	LENGTH
95-1005L	Direct Drive, Locking Ratchet on Demand	5 mm	33 cm
95-1015L	Direct Drive, Locking Ratchet on Demand	10 mm	33 cm
95-1005L-45	Direct Drive, Locking Ratchet on Demand	5 mm	45 cm
95-1015L-45	Direct Drive, Locking Ratchet on Demand	10 mm	45 cm



DeBakey Grasping Forceps

CODE	DESCRIPTION	DIAMETER	TIP SIZE	LENGTH
95-1092L	Direct Drive, Locking Ratchet on Demand	5 mm	40 mm	33 cm
95-1092L-45	Direct Drive, Locking Ratchet on Demand	5 mm	40 mm	45 cm

Dorsey Grasping Forceps

Fenestrated

CODE	DESCRIPTION	DIAMETER	TIP SIZE	LENGTH
95-1031SL	Direct Drive, Slide Lock	5 mm	30 mm	34.5 cm

Symmetry Surgical Laparoscopic Instruments

360° rotation with flush port and Direct Drive system.
Laparoscopic instrumentation available in 45 cm length (-45).

Grasping Forceps

Blunt Tip



CODE	DESCRIPTION	DIAMETER	LENGTH
95-1032L	Direct Drive, Locking Ratchet on Demand	5 mm	33 cm



Hook Scissors

CODE	DESCRIPTION	DIAMETER	LENGTH
95-2020-45	Direct Drive, Non-Locking	5 mm	45 cm



Hunter Bowel Grasping Forceps

CODE	DESCRIPTION	DIAMETER	TIP SIZE	LENGTH
95-1093L	Direct Drive, Locking Ratchet on Demand	5 mm	20 mm	33 cm

Symmetry Surgical Laparoscopic Instruments

360° rotation with flush port and Direct Drive system.
Laparoscopic instrumentation available in 45 cm length (-45).



Tip

Maryland Dissecting Forceps

Curved

CODE	DESCRIPTION	DIAMETER	LENGTH
95-1067	Direct Drive, Non-Locking	5 mm	33 cm



Tip

95-2006

Metzenbaum Scissors

Curved

CODE	DESCRIPTION	DIAMETER	LENGTH
95-2006	Direct Drive, Non-Locking	5 mm	33 cm
95-2006-45	Direct Drive, Non-Locking	5 mm	45 cm



Needle Nose Grasping Forceps

CODE	DESCRIPTION	DIAMETER	LENGTH
95-1045L	Direct Drive, Locking Ratchet on Demand	5 mm	32 cm

Symmetry Surgical Laparoscopic Instruments

360° rotation with flush port and Direct Drive system.
Laparoscopic instrumentation available in 45 cm length (-45).



Retraction Grasping Forceps

CODE	DESCRIPTION	DIAMETER	LENGTH
95-1056L	Direct Drive, Locking Ratchet on Demand, Single-Action	5 mm	33 cm



95-1048SL-DA-ROT

Retraction Grasping Forceps

CODE	DESCRIPTION	DIAMETER	LENGTH
95-1048	Single-Action	5 mm	33 cm
95-1048SL-ROT	Single-Action, Rotation	5 mm	35 cm
95-1048SL-ROT-45	Single-Action, Rotation	5 mm	45 cm
95-1048SL-DA	Double-Action	5 mm	35 cm
95-1048SL-DA-ROT	Double-Action, Rotation	5 mm	35 cm



95-1070

Stone Retrieval Forceps

CODE	DESCRIPTION	DIAMETER	LENGTH
95-1070	Direct Drive, Non-Locking	10 mm	33 cm

Symmetry Surgical Laparoscopic Instruments

360° rotation with flush port and Direct Drive system.
Laparoscopic instrumentation available in 45 cm length (-45).

Wave Grasping Forceps

Slide Lock Handle



CODE	DESCRIPTION	DIAMETER	LENGTH
95-1049SL		5 mm	33 cm
95-1049SL-45	Single-Action	5 mm	45 cm
95-1049SL-ROT	Single-Action, Rotation	5 mm	35 cm
95-1049SL-ROT-45	Single-Action, Rotation	5 mm	45 cm
95-1049SL-DA	Double-Action	5 mm	35 cm
95-1049SL-DA-45	Double-Action	5 mm	45 cm
95-1049SL-DA-ROT	Double-Action, Rotation	5 mm	35 cm

Wave Grasping Forceps



CODE	DESCRIPTION	DIAMETER	LENGTH
95-1051L	Direct Drive, Locking Ratchet on Demand, Single-Action	5 mm	33 cm

Wave Grasping Forceps

Double-Action



CODE	DESCRIPTION	DIAMETER	LENGTH
95-1053L	Direct Drive, Locking Ratchet on Demand	5 mm	33 cm
95-1053L-45	Direct Drive, Locking Ratchet on Demand	5 mm	45 cm

Symmetry Surgical Laparoscopic Instruments

360° rotation with flush port.

Laparoscopic instruments available in 45 cm length.



Tip

Atraumatic-Allis Grasping Forceps

CODE	DESCRIPTION	DIAMETER	LENGTH
97-1077RC	Ratchet Handle and Rotation	5 mm	35 cm

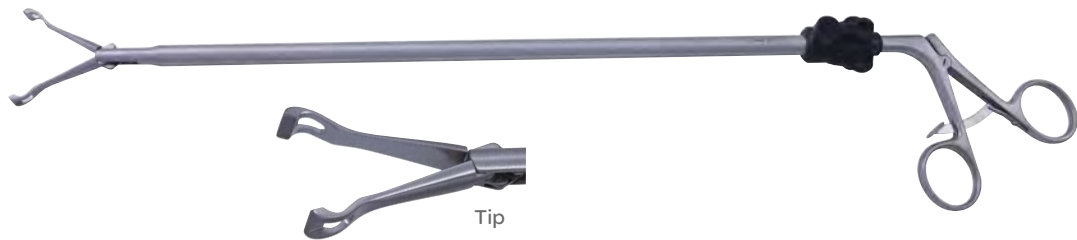

Tip

97-1079RC

Babcock Grasping Forceps

CODE	DESCRIPTION	DIAMETER	LENGTH
97-1089RC	Ratchet Handle and Rotation, Double-Action	5 mm	32 cm
97-1079RC	Ratchet Handle and Rotation, Double-Action	10 mm	37 cm



Tip

97-1030RC

Bottle Nose (Dolphin Nose) Dissecting Forceps

CODE	DESCRIPTION	DIAMETER	LENGTH
97-1030RC	Non-Locking Handle with Rotation, Fully-Insulated, Double-Action	5 mm	32 cm
97-1030RCL	Non-Locking Handle with Rotation, Fully-Insulated, Double-Action	5 mm	45 cm

Symmetry Surgical Laparoscopic Instruments

360° rotation with flush port.
Laparoscopic instruments available in 45 cm length.



Tip

Bowel Grasping Forceps

Fenestrated

CODE	DESCRIPTION	DIAMETER	LENGTH
97-1093RC	Ratchet Handle and Rotation	5 mm	32 cm



Cup Tooth Dissecting Forceps

CODE	DESCRIPTION	DIAMETER	LENGTH
97-1035RC	Non-Locking Handle with Rotation, Fully-Insulated, Double-Action	5 mm	32 cm



Tip

Cup Tooth Grasping Forceps

CODE	DESCRIPTION	DIAMETER	LENGTH
97-1055RC	Ratchet Handle and Rotation, Double-Action	5 mm	32 cm

Symmetry Surgical Laparoscopic Instruments

360° rotation with flush port.

Laparoscopic instruments available in 45 cm length.



Dorsey Grasping Forceps

Fenestrated

CODE	DESCRIPTION	DIAMETER	TIP SIZE	LENGTH
97-1031RC	Ratchet Handle and Rotation	5 mm	30 mm	32 cm

Duckbill Dissecting Forceps

Monopolar, Fully-Insulated



CODE	DESCRIPTION	DIAMETER	LENGTH
97-1040RC	Flattened Serrated Jaws, Non-Locking Handle with Rotation	5 mm	32 cm

Duval Grasping Forceps

CODE	DESCRIPTION	DIAMETER	LENGTH
97-1083RCL	Ratchet Handle and Rotation	10 mm	45 cm
97-1083RC	Ratchet Handle and Rotation	10 mm	32 cm

Symmetry Surgical Laparoscopic Instruments

360° rotation with flush port.
Laparoscopic instruments available in 45 cm length.



Hook Scissors

CODE	DESCRIPTION	DIAMETER	LENGTH
97-2020RC	Rotation, Fully-Insulated, Single-Action	5 mm	32 cm



Hunter Bowel Grasping Forceps

CODE	DESCRIPTION	DIAMETER	TIP SIZE	LENGTH
97-1090RC	Non-Locking Handle and Rotation, Fenestrated	5 mm	20 mm	32 cm
97-1090RCL	Non-Locking Handle and Rotation, Fenestrated	5 mm	20 mm	45 cm

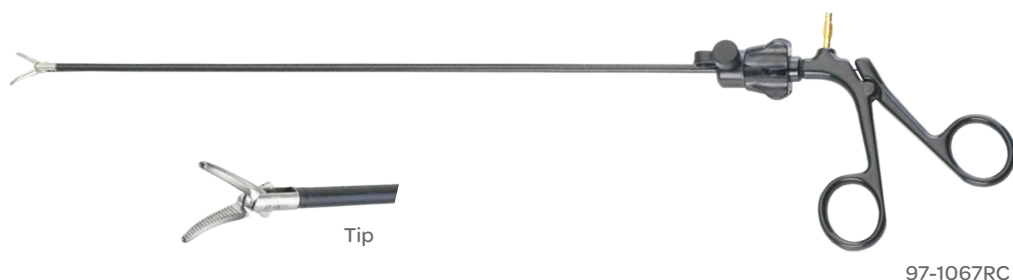

Maryland Dissecting Forceps

Curved, Fully Insulated

CODE	DESCRIPTION	DIAMETER	LENGTH
97-1067RC	Non-Locking Handle and Rotation	5 mm	32 cm
97-1067RCL	Non-Locking Handle and Rotation	5 mm	45 cm

Symmetry Surgical Laparoscopic Instruments

360° rotation with flush port.

Laparoscopic instruments available in 45 cm length.

Maryland Tapered Dissecting Forceps

Monopolar

CODE	DESCRIPTION	DIAMETER	LENGTH
97-1063RC	Non-Locking Handle, Fully Insulated with Rotation	5 mm	35 cm



Metzenbaum Endo Scissors

CODE	DESCRIPTION	DIAMETER	LENGTH
97-2006RC	Non-Locking Handle with Rotation, Fully Insulated	5 mm	32 cm
97-2006RCL	Non-Locking Handle with Rotation, Fully Insulated	5 mm	45 cm



Mixer Dissecting Forceps

Double-Action

CODE	DESCRIPTION	DIAMETER	LENGTH
97-1066RC	Non-Locking Handle and Rotation, Fully Insulated	5 mm	33 cm
97-1068RC	Non-Locking Handle and Rotation, Fully Insulated	10 mm	33 cm
97-1068RCL	Non-Locking Handle and Rotation, Fully Insulated	10 mm	45 cm

Symmetry Surgical Laparoscopic Instruments

360° rotation with flush port.
Laparoscopic instruments available in 45 cm length.



Tip

Retraction Grasping Forceps

CODE	DESCRIPTION	DIAMETER	LENGTH
97-1056RC	Ratchet Handle and Rotation, Single-Action	5 mm	37 cm



Tip

Snake Tooth (COBRA) Grasping Forceps

CODE	DESCRIPTION	DIAMETER	LENGTH
97-1069RC	Ratchet Handle and Rotation	5 mm	37 cm



Tip

Swanstrom Grasping Forceps

CODE	DESCRIPTION	DIAMETER	LENGTH
97-1080RC	Ratchet Handle and Rotation	5 mm	37 cm

Symmetry Surgical Laparoscopic Instruments

360° rotation with flush port.

Laparoscopic instruments available in 45 cm length.



Tenaculum Grasping Forceps

CODE	DESCRIPTION	DIAMETER	LENGTH
97-1008RC	Ratchet Handle and Rotation	5 mm	33 cm

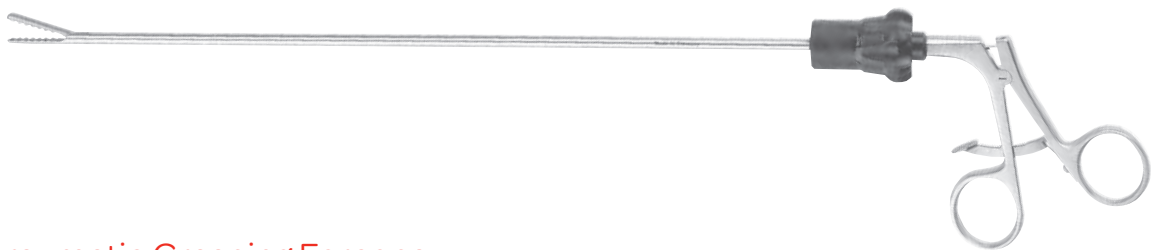

Wave Atraumatic Grasping Forceps

CODE	DESCRIPTION	DIAMETER	LENGTH
97-1051RC	Ratchet Handle and Rotation, Single-Action	5 mm	37 cm
97-1051DA-RC	Ratchet Handle and Rotation, Double-Action	5 mm	37 cm



Allis Grasping Forceps

CODE	DESCRIPTION	DIAMETER	LENGTH
97-1078RC	Ratchet Handle and Rotation	5 mm	32 cm

Symmetry Surgical RapidClean® Instruments

Three-piece modular system with choice of insulated, spring or ratchet handle; outer shaft and jaw assembly.



90-0030

Handle

For 90-Series Modular Instruments

CODE	DESCRIPTION
90-0030	Insulated with Cautery Post and Rotation Knob
90-0020	Non-Insulated with Spring Handle and Rotation Knob
90-0010	Non-Insulated with Ratchet and Rotation Knob



90-1115

Insulated Outer Shaft

CODE	DESCRIPTION	DIAMETER	LENGTH
90-1115	With Flushport	5 mm	32 cm
90-1115L	With Flushport	5 mm	45 cm
90-1116	Without Flushport	5 mm	32 cm
90-1116L	Without Flushport	5 mm	45 cm
90-1117	Without Flushport	10 mm	32 cm
90-1117L	Without Flushport	10 mm	45 cm

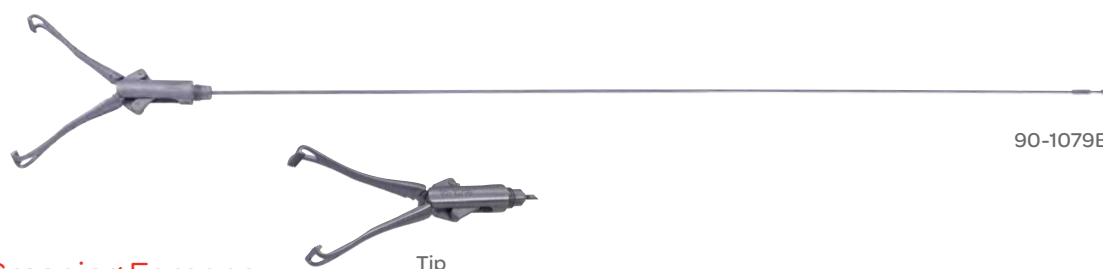

90-1079B

Babcock Grasping Forceps

Double-Action

CODE	DESCRIPTION	DIAMETER	LENGTH
90-1079R	Non-Insulated with Ratchet and Rotation Knob	10 mm	32 cm
90-1079B	Replacement Jaw Assembly		

Symmetry Surgical RapidClean® Instruments

Three-piece modular system with choice of insulated, spring or ratchet handle; outer shaft and jaw assembly.



Babcock Grasping Forceps

Double-Action

CODE	DESCRIPTION	DIAMETER	LENGTH
90-1079RL	Non-Insulated with Ratchet and Rotation Knob	10 mm	45 cm
90-1079BL	Replacement Jaw Assembly		

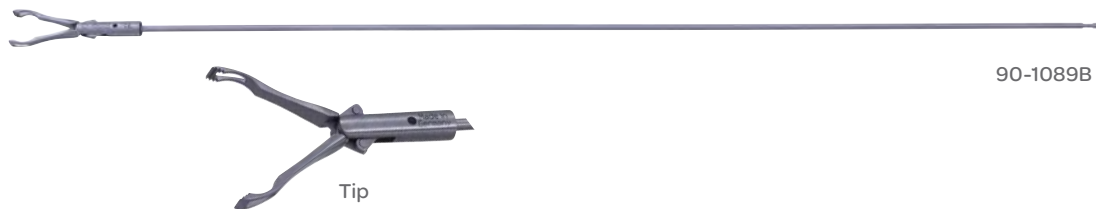

Babcock Grasping Forceps

Double-Action

CODE	DESCRIPTION	DIAMETER	LENGTH
90-1089R	Non-Insulated with Ratchet and Rotation Knob	5 mm	32 cm
90-1089B	Replacement Jaw Assembly		



Biopsy Forceps

Monopolar Single-Action

CODE	DESCRIPTION	DIAMETER	LENGTH
90-1075R	Non-Insulated Ratchet Handle with Rotation Knob	5 mm	32 cm
90-1075B	Replacement Jaw Assembly		

Symmetry Surgical RapidClean® Instruments

Three-piece modular system with choice of insulated, spring or ratchet handle; outer shaft and jaw assembly.



Bottle Nose (Dolphin Nose)

Dissecting Forceps

CODE	DESCRIPTION	DIAMETER	LENGTH
90-1030I	Monopolar, Double-Action, Insulated Handle	5 mm	32 cm
90-1030IL	Monopolar, Double-Action, Insulated Handle	5 mm	45 cm
90-1030B	Replacement Jaw Assembly		
90-1030BL	Replacement Jaw Assembly		



Claw Grasping Extractor Forceps

2x3 Heavy Teeth, Single-Action

CODE	DESCRIPTION	DIAMETER	LENGTH
90-1015S	Spring Handle	10 mm	32 cm
90-1015B	Replacement Jaw Assembly		



Claw Grasping Extractor Forceps

2x3 Heavy Teeth, Single-Action

CODE	DESCRIPTION	DIAMETER	LENGTH
90-1005S	Spring Handle	5 mm	32 cm
90-1005B	Replacement Jaw Assembly		

Symmetry Surgical RapidClean® Instruments

Three-piece modular system with choice of insulated, spring or ratchet handle; outer shaft and jaw assembly.



Cup Tooth Dissecting Forceps

CODE	DESCRIPTION	DIAMETER	LENGTH
90-1035I	Insulated Handle, Double-Action	5 mm	32 cm
90-1035B	Replacement Jaw Assembly		



Duckbill Dissecting Forceps

CODE	DESCRIPTION	DIAMETER	LENGTH
90-1040I	Monopolar, Fully-Insulated, Flattened Serrated Jaws, Double-Action with Insulated Handle	5 mm	32 cm
90-1040B	Replacement Jaw Assembly		



Fenestrated Dissecting Forceps

CODE	DESCRIPTION	DIAMETER	LENGTH
90-1042IL	Insulated Handle with Rotation Knob	5 mm	45 cm
90-1042BL	Replacement Jaw Assembly		

Symmetry Surgical RapidClean® Instruments

Three-piece modular system with choice of insulated, spring or ratchet handle; outer shaft and jaw assembly.



90-1042B

Fenestrated Grasping Forceps

Double-Action

CODE	DESCRIPTION	DIAMETER	LENGTH
90-1042R	Non-Insulated Ratchet Handle with Rotation Knob	5 mm	32 cm
90-1042B	Replacement Jaw Assembly		



90-1050B

Fundus Trimax Grasping Forceps

CODE	DESCRIPTION	DIAMETER	LENGTH
90-1050R	Ratchet Handle, Double-Action	5 mm	33 cm
90-1050B	Replacement Jaw Assembly, Double-Action		



Tip

Maryland Dissecting Forceps

CODE	DESCRIPTION	DIAMETER	LENGTH
90-1067I	Monopolar, Fully-Insulated, Double-Action with Insulated Handle	5 mm	32 cm
90-1067B	Replacement Jaw Assembly		

Symmetry Surgical RapidClean® Instruments

Three-piece modular system with choice of insulated, spring or ratchet handle; outer shaft and jaw assembly.



Tip

Maryland Dissecting Forceps

CODE	DESCRIPTION	DIAMETER	LENGTH
90-1067IL	Monopolar, Fully-Insulated, Double-Action with Insulated Handle	5 mm	45 cm
90-1067BL	Replacement Jaw Assembly		



Tip

90-1065I

Maryland Dissecting Forceps

CODE	DESCRIPTION	DIAMETER	LENGTH
90-1065I	Monopolar, Fully-Insulated, Double-Action with Insulated Handle	10 mm	32 cm
90-1065B	Replacement Jaw Assembly		



Tip

90-1066B

Mixer Dissecting Forceps

CODE	DESCRIPTION	DIAMETER	LENGTH
90-1066I	Double-Action with Insulated Handle	5 mm	32 cm
90-1066B	Replacement Jaw Assembly		

Symmetry Surgical RapidClean® Instruments

Three-piece modular system with choice of insulated, spring or ratchet handle; outer shaft and jaw assembly.



Mixer Dissecting Forceps

CODE	DESCRIPTION	DIAMETER	LENGTH
90-1068I	Double-Action with Insulated Handle	10 mm	32 cm
90-1068B	Replacement Jaw Assembly		



Snake Tooth (COBRA) Grasping Forceps

2 x 2 Teeth, Double-Action

CODE	DESCRIPTION	DIAMETER	LENGTH
90-1069R	Non-Insulated Ratchet Handle with Rotation Knob	5 mm	32 cm
90-1069B	Replacement Jaw Assembly		



Spike Tooth Grasper

CODE	DESCRIPTION	DIAMETER	LENGTH
90-1071R	Non-Insulated Ratchet Handle with Rotation Knob	5 mm	32 cm
90-1071B	Replacement Jaw Assembly		

Symmetry Surgical RapidClean® Instruments

Three-piece modular system with choice of insulated, spring or ratchet handle; outer shaft and jaw assembly.



Stone Retrieval Forceps

Single-Action, Ratchet Handle

CODE	DESCRIPTION	DIAMETER	LENGTH
90-1070R	Spoon tips	10 mm	32 cm
90-1070B	Replacement Jaw Assembly		



Surgi-Shear 2-Piece Scissors

Double-Action, Curved Beak-Like Blades

CODE	DESCRIPTION	DIAMETER	LENGTH
90-2006I	Double-Action with Insulated Handle	5 mm	32 cm
90-2008B	Replacement Jaw Assembly with Outer Sheath		



Wave Atraumatic Grasping Forceps

CODE	DESCRIPTION	DIAMETER	LENGTH
90-1051R	Ratchet and Rotation Knob	5 mm	32 cm
90-1051B	Replacement Jaw Assembly		

Symmetry Surgical RapidClean® Instruments

Three-piece modular design instruments with click and rotate.
Laparoscopic instruments available in 45 cm length.

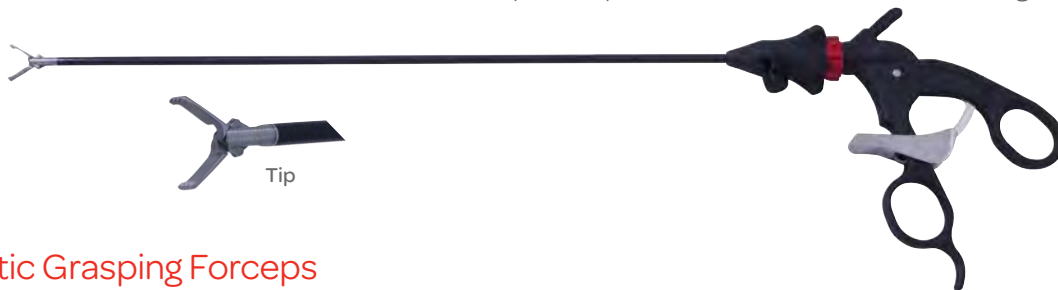

Allis Atraumatic Grasping Forceps

Complete Instrument: Consists of Sheath, Replacement Jaw Assembly and Locking Carbon Fiber Handle

CODE	DIAMETER	LENGTH
96-1023R	5 mm	33 cm



Babcock Grasping Forceps

Complete Instrument: Consists of Sheath, Replacement Jaw Assembly and Locking Carbon Fiber Handle

CODE	DESCRIPTION	DIAMETER	LENGTH
96-1089R	DeBakey Teeth	5 mm	33 cm
96-1079R	DeBakey Teeth	10 mm	33 cm



Bottle Nose (Dolphin Nose) Grasping Forceps

Complete Instrument: Consists of Sheath, Replacement Jaw Assembly and Non-Locking Carbon Fiber Handle

CODE	DESCRIPTION	DIAMETER	LENGTH
96-1030NL	Monopolar, Double-Action	5 mm	33 cm

Symmetry Surgical RapidClean® Instruments

Three-piece modular design instruments with click and rotate.
Laparoscopic instruments available in 45 cm length.



Carbon Fiber Handle

For 96-Series Click and Rotating Modular Instruments

CODE	DESCRIPTION
96-0002NL	Non-Locking Carbon Fiber Handle
96-0003R	Locking Carbon Fiber Handle
96-0004R	Traditional Locking Ratchet Handle

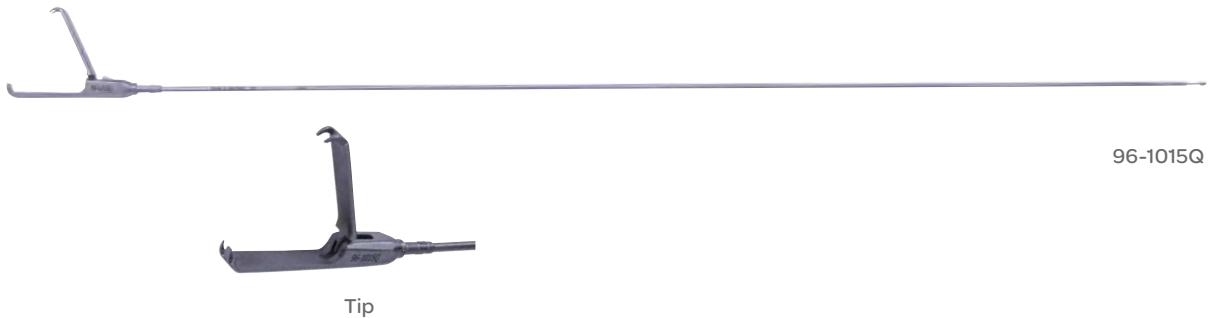

96-1015Q

Claw Grasping Extractor Forceps

Complete Instrument: Consists of Sheath, Replacement Jaw Assembly and Locking Carbon Fiber Handle

CODE	DESCRIPTION	DIAMETER	LENGTH
96-1015R	2 x 3 Heavy Teeth, Single Action, Locking Carbon Fiber Handle	10 mm	33 cm



96-1035NL

Cup Tooth Dissecting Forceps

Complete Instrument: Consists of Sheath, Replacement Jaw Assembly and Non-Locking Carbon Fiber Handle

CODE	DESCRIPTION	DIAMETER	LENGTH
96-1035NL	Double-Action	5 mm	33 cm

Symmetry Surgical RapidClean® Instruments

Three-piece modular design instruments with click and rotate.
Laparoscopic instruments available in 45 cm length.



DeBakey Grasping Forceps

Complete Instrument: Consists of Sheath, Replacement Jaw Assembly and Locking Carbon Fiber Handle

CODE	DESCRIPTION	DIAMETER	TIP SIZE	LENGTH
96-1092NL	Double-Action	5 mm	40 mm	33 cm



Duckbill Dissecting Forceps

Complete Instrument: Consists of Sheath, Replacement Jaw Assembly and Non-Locking Carbon Fiber Handle

CODE	DESCRIPTION	DIAMETER	LENGTH
96-1022NL	Monopolar, Fully-Insulated Double-Action, with Insulated Handle, with Flattened Serrated Jaws	5 mm	33 cm



Fenestrated Dissecting Forceps

Complete Instrument: Consists of Sheath, Replacement Jaw Assembly and Non-Locking Carbon Fiber Handle

CODE	DESCRIPTION	DIAMETER	LENGTH
96-1042NL	Double-Action with Insulated Handle	5 mm	33 cm

Symmetry Surgical RapidClean® Instruments

Three-piece modular design instruments with click and rotate.
Laparoscopic instruments available in 45 cm length.

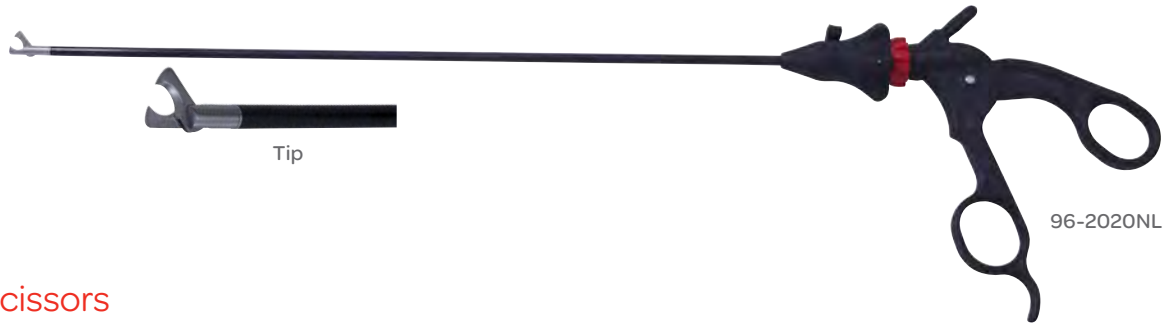

Hook Scissors

CODE	DESCRIPTION	DIAMETER	LENGTH
96-2020NL	Consists of Sheath, Replacement Jaw Assembly and Non-Locking Carbon Fiber Handle	5 mm	33 cm

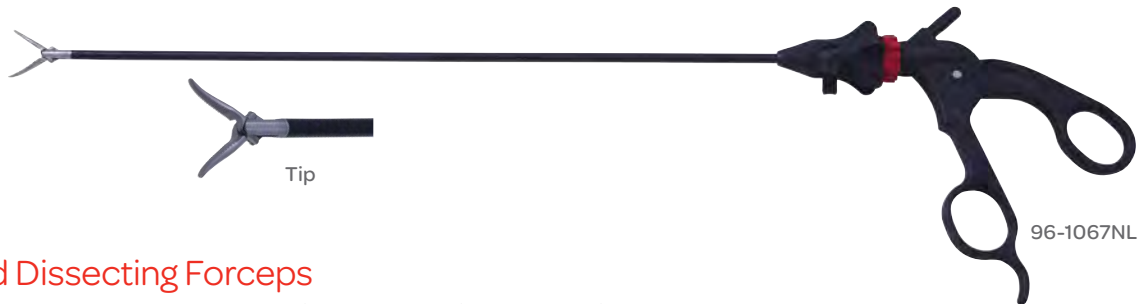

Maryland Dissecting Forceps

Monopolar, Fully-Insulated, Double-Action, Non-Locking Carbon Fiber Handle

CODE	DESCRIPTION	DIAMETER	LENGTH
96-1067NL	Consists of Sheath, Replacement Jaw Assembly and Non-Locking Carbon Fiber Handle	5 mm	33 cm
90-1067BL	Replacement Jaw Assembly		



Mixer Dissecting

Complete Instrument: Consists of Sheath, Replacement Jaw Assembly and Non-Locking Carbon Fiber Handle

CODE	DIAMETER	LENGTH
96-1068NL	10 mm	33 cm

Symmetry Surgical RapidClean® Instruments

Three-piece modular design instruments with click and rotate.
Laparoscopic instruments available in 45 cm length.



Mixer Dissecting Forceps

Complete Instrument: Consists of Sheath, Replacement Jaw Assembly and Non-Locking Carbon Fiber Handle

CODE	DIAMETER	LENGTH
96-1066NL	5 mm	33 cm



Outer Sheath

For 96-Series Modular Instruments

96-0526

CODE	DESCRIPTION	DIAMETER
96-0526	Rotation and Flush Port, for 33 cm Instruments	5 mm
96-0526-45	Rotation and Flush Port, for 45 cm Instruments	5 mm
96-0126	Rotation and Flush Port, for 10 cm Instruments	10 mm

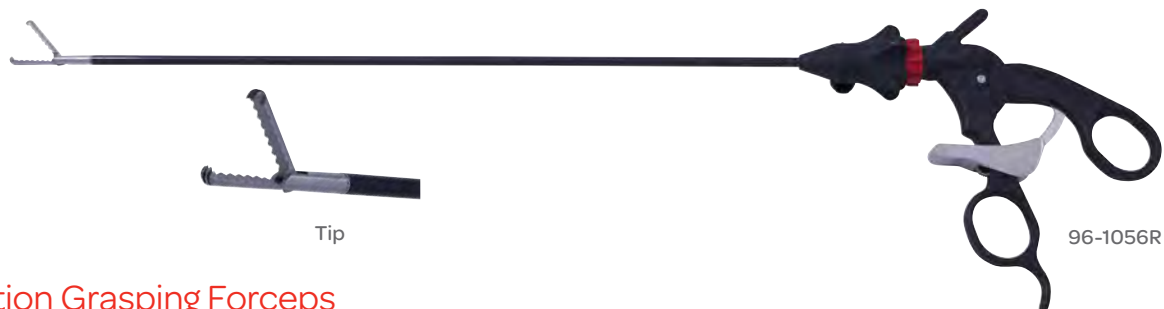

Retraction Grasping Forceps

Complete Instrument: Consists of Sheath, Replacement Jaw Assembly and Locking Carbon Fiber Handle

CODE	DESCRIPTION	DIAMETER	LENGTH
96-1056R	Atraumatic Teeth	5 mm	33 cm

Symmetry Surgical RapidClean® Instruments

Three-piece modular design instruments with click and rotate.
Laparoscopic instruments available in 45 cm length.

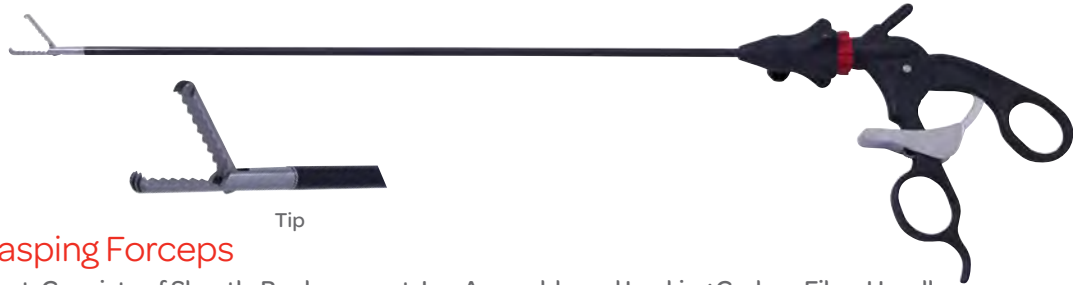

Retraction Grasping Forceps

Complete Instrument: Consists of Sheath, Replacement Jaw Assembly and Locking Carbon Fiber Handle

CODE	DESCRIPTION	DIAMETER	LENGTH
96-1056R-45	Atraumatic Teeth	5 mm	45 cm

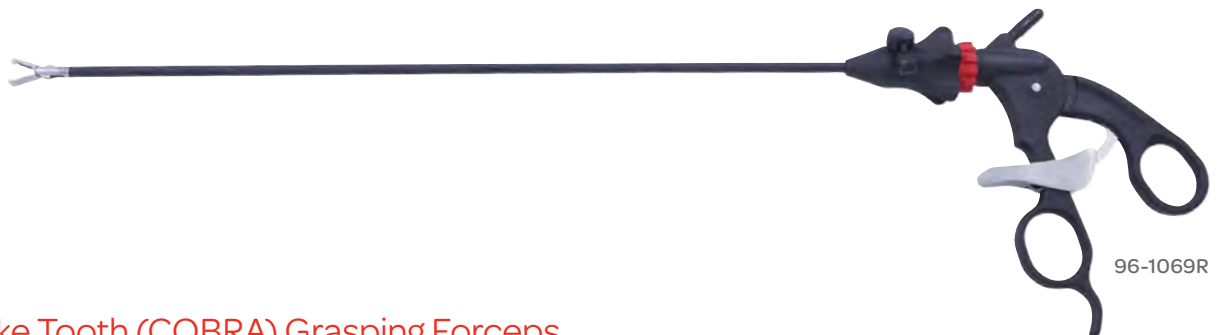

Snake Tooth (COBRA) Grasping Forceps

Complete Instrument: Consists of Sheath, Replacement Jaw Assembly and Locking Carbon Fiber Handle

CODE	DESCRIPTION	DIAMETER	LENGTH
96-1069R	2 x 2 Teeth, Double-Action	5 mm	33 cm



Stone Retrieval Forceps

Complete Instrument: Consists of Sheath, Replacement Jaw Assembly and Locking Carbon Fiber Handle

CODE	DESCRIPTION	DIAMETER	LENGTH
96-1070R	Single-Action	5 mm	33 cm

Symmetry Surgical RapidClean® Instruments

Three-piece modular design instruments with click and rotate.
Laparoscopic instruments available in 45 cm length.

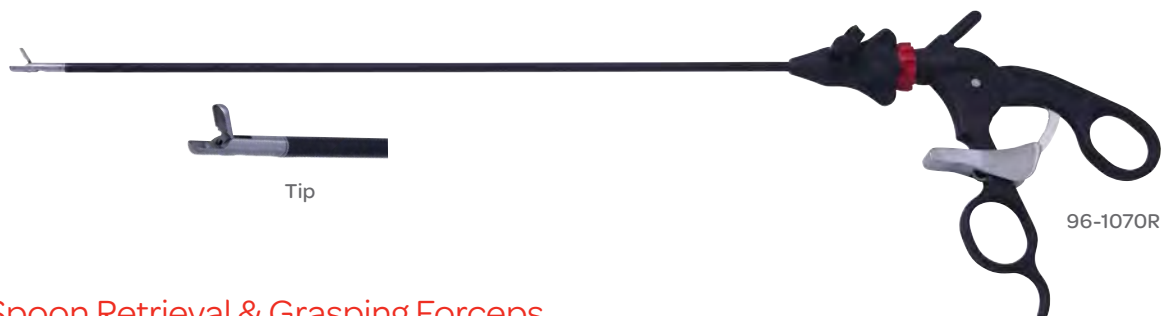

Stone Spoon Retrieval & Grasping Forceps

Complete Instrument: Consists of Sheath, Replacement Jaw Assembly and Locking Carbon Fiber Handle

CODE	DESCRIPTION	DIAMETER	LENGTH
96-1072R	Ratchet Handle, Single-Action	10 mm	33 cm



Tenaculum Grasping Forceps

Complete Instrument: Consists of Sheath, Replacement Jaw Assembly and Locking Carbon Fiber Handle

CODE	DESCRIPTION	DIAMETER	LENGTH
96-1008R	Locking, 1 x 1 Sharp Teeth, Double-Action	5 mm	33 cm

Tenaculum Grasping Forceps

Complete Instrument: Consists of Sheath, Replacement Jaw Assembly and Locking Carbon Fiber Handle

CODE	DESCRIPTION	DIAMETER	LENGTH
96-1009R	Locking, 1 x 1 Sharp Teeth, Double-Action	10 mm	33 cm

Symmetry Surgical RapidClean® Instruments

Three-piece modular design instruments with click and rotate.
Laparoscopic instruments available in 45 cm length.



96-1053R

Wave Atraumatic Grasping Forceps

Complete Instrument: Consists of Sheath, Replacement Jaw Assembly and Locking Carbon Fiber Handle

CODE	DESCRIPTION	DIAMETER	LENGTH
96-1053R	Locking, Double-Action	5 mm	33 cm

Symmetry Ultra™ Kleppinger Type Bipolar Forceps

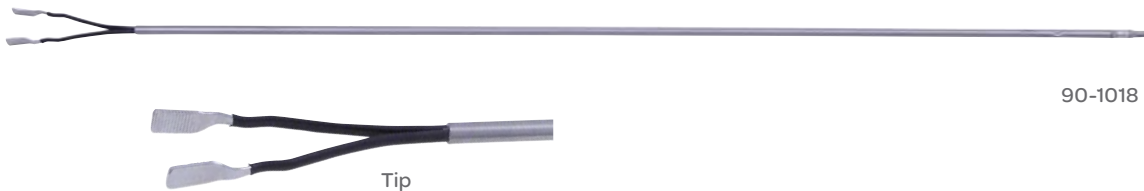

90-1018

Tip

Paddle Tong

CODE	DESCRIPTION	DIAMETER	LENGTH
90-1018	Insert Only	5 mm	32 cm
90-1019	Insert Only	5 mm	45 cm

Symmetry Ultra™ Kleppinger Type Bipolar Forceps



Ring Handle

CODE	DESCRIPTION	DIAMETER	LENGTH
90-1011	Ring Handle	5 mm	32 cm
90-1012	Ring Handle	5 mm	45 cm

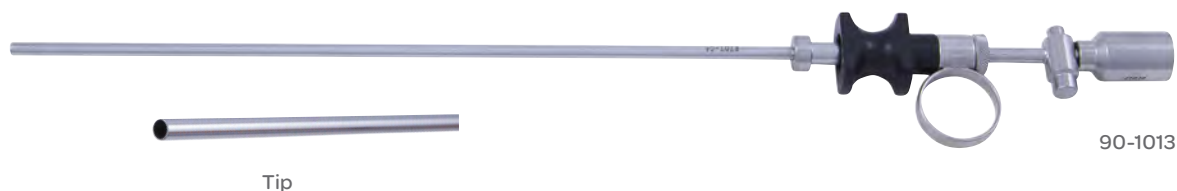

Thumb Ring

CODE	DESCRIPTION	DIAMETER	LENGTH
90-1013	Thumb Ring	5 mm	32 cm
90-1014	Thumb Ring	5 mm	45 cm



Waffle Tong

CODE	DESCRIPTION	DIAMETER	LENGTH
90-1016	Insert Only	5 mm	32 cm
90-1017	Insert Only	5 mm	45 cm

Electrodes

Laparoscopic Monopolar Electrodes

Single-Use, 10 per Box

CODE	DESCRIPTION	LENGTH	
90-9525-S	J-Hook	13 in	33 cm
90-9525-45S	J-Hook	17 ³ / ₄ in	45 cm
90-9522-S	L-Hook	13 in	33 cm
90-9522-45S	L-Hook	17 ³ / ₄ in	45 cm
90-9523-S	Spatula	13 in	33 cm
90-9523-45S	Spatula	17 ³ / ₄ in	45 cm



Laparoscopic Monopolar Electrode

Reusable

CODE	DESCRIPTION	LENGTH	
90-9525	J-Hook	12 ¹ / ₂ in	32 cm
90-9522	L-Hook	12 ¹ / ₂ in	32 cm
90-9523	Spatula	12 ¹ / ₂ in	32 cm
90-9526	Needle	12 ¹ / ₂ in	32 cm
90-9527	Button Tip	12 ¹ / ₂ in	32 cm



Laparoscopic Monopolar Suction/Irrigation Electrode

Reusable, 5 mm Shaft, with Valve, Fully Insulated

CODE	DESCRIPTION	LENGTH	
90-4005	J-Hook	12 ¹ / ₂ in	32 cm
90-4012	L-Hook	12 ¹ / ₂ in	32 cm
90-4015	Spatula	12 ¹ / ₂ in	32 cm
90-4010	Button Tip	12 ¹ / ₂ in	32 cm



Electrodes



Monopolar Cords

Single-Use, 10 per Box

CODE	DESCRIPTION	PLUG	LENGTH
40-2110	Endoscopic Instrument Connector, Straight	Valleylab-Style Generator	10 ft 3 m
40-2106	Endoscopic Instrument Connector, Angled 90°	Valleylab-Style Generator	10 ft 3 m



Monopolar Cords

Reusable, 1 Each

CODE	DESCRIPTION	PLUG	LENGTH
90018	Olsen® Threaded Instrument Connector	$\frac{5}{32}$ in (4 mm) Male Generator	10 ft 3 m
90020	Olsen® Threaded Instrument Connector	Valleylab-Style Male Generator	10 ft 3 m
90054	Laparoscopic Instrument Connector	$\frac{5}{32}$ in (4 mm) Male Generator	10 ft 3 m
90056	Laparoscopic Instrument Connector	Valleylab-Style Male Generator	10 ft 3 m
90065	3 mm Olympus-Style Snare Connector	$\frac{5}{32}$ in (4 mm) Male Generator	10 ft 3 m
90067	3 mm Olympus-Style Snare Connector	Valleylab-Style Male Generator	10 ft 3 m
50-2107	Endoscopic Instrument Connector, Straight	Valleylab-Style Male Generator	10 ft 3 m
50-2111	Endoscopic Instrument Connector, Angled 90°	Valleylab-Style Male Generator	10 ft 3 m

Sterilization Solutions



Prevac Base & Lid

CODE	DESCRIPTION	DIMENSIONS	
C22854	Endoscopic Length	22 x 8 ½ x 4 in	559 x 216 x 101 mm
C22855	Endoscopic Length	22 x 8 ½ x 5 in	559 x 216 x 127 mm
C22856	Endoscopic Length	22 x 8 ½ x 6 in	559 x 216 x 152 mm
C22858	Endoscopic Length	22 x 8 ½ x 8 in	559 x 216 x 203 mm
C24138	Full Length	24 x 12 x 8 in	610 x 305 x 203 mm



C13854-SP



C22856-S

Sterrad Base & Lid

CODE	DESCRIPTION	DIMENSIONS	
C22854-SP	Endoscopic Length	22 x 8 ½ x 4 in	558 x 215 x 101 mm
C22856-SP	Endoscopic Length	22 x 8 ½ x 6 in	558 x 215 x 152 mm

Sterilization Solutions



Ultra™ Container System

The lightweight Ultra™ Container System helps keep heavy instrument sets within AORN and AAMI limits. Designed for durability, it weighs 30% less than comparable sterilization systems.

KEY BENEFITS:

- Extruded rails reinforce the base and lid rims
- 13 inch (330 mm) width provides acceptable packaging for most loaner instrumentation trays
- Five sizes accommodate both general and specialty instruments

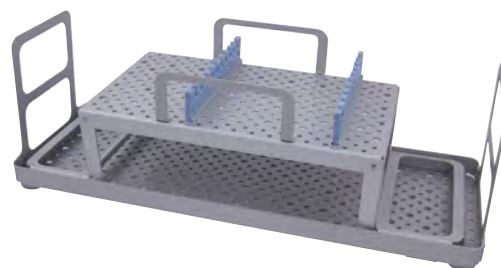

B2175-LAP

Large Laparoscopic Insert

CODE	DESCRIPTION	HOLDS	DIMENSIONS
B2175-LAP	Small Insert, For use with C22858	10 Instruments	21 x 7½ x 6 in 533 x 190 x 152 mm
B2312-LAP	Large Insert, For use with C24138	15 Instruments	23 x 12 x 6 in 584 x 305 x 152 mm



68-1599

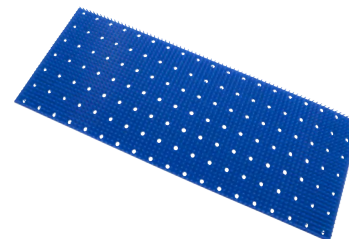

68-1598

Laparoscopic Instrument Tray

CODE	DESCRIPTION
68-1599	Instrument Tray
68-1598	Pin Mat for Laparoscopic Instrument Tray



Scan the code above to learn more about our Neuro portfolio.

Neuro Portfolio



symmetry surgical™

Neuro

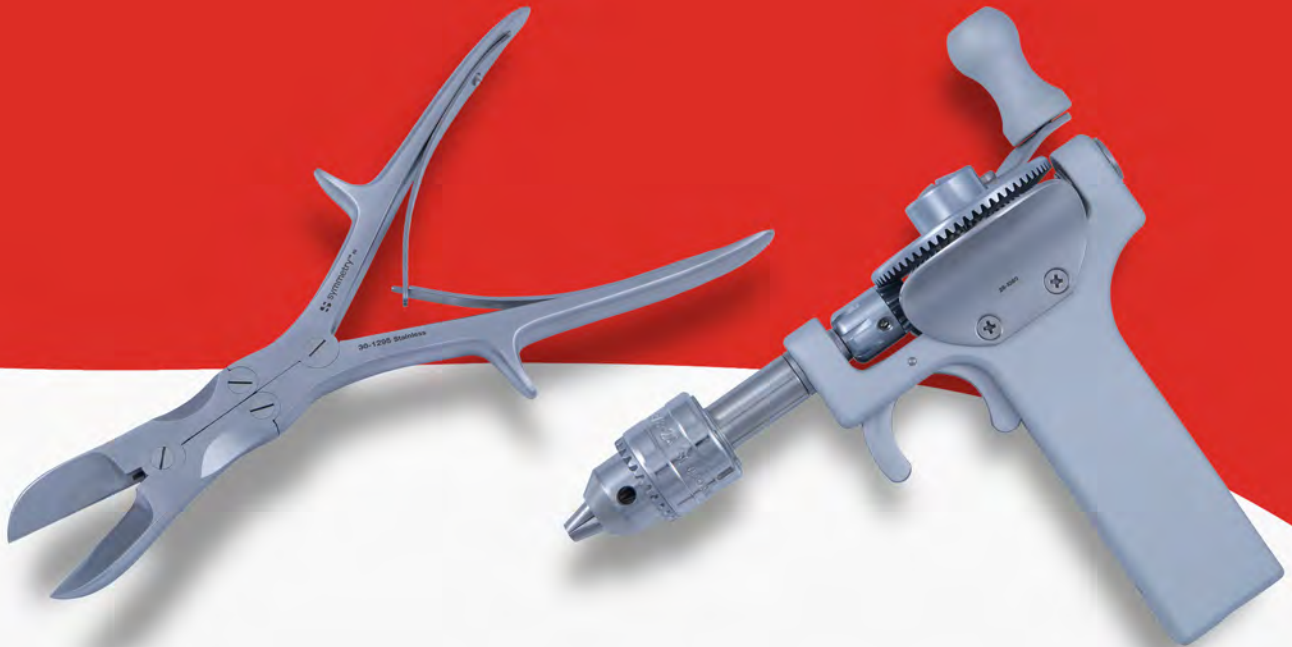

Blades	NEU-2	Mallets	NEU-56	Skull Tongs	NEU-122
Calipers	NEU-2	Markers	NEU-57	Spatulas	NEU-123
Cannulas	NEU-2	Mirrors	NEU-57	Speculums	NEU-125
Clips	NEU-2	Needle Holders	NEU-57	Sponges	NEU-126
Containers	NEU-3	Needles	NEU-61	Spoons	NEU-126
Cords	NEU-6	Osteotomes	NEU-61	Kits	NEU-127
Curettes	NEU-6	Probes	NEU-62	Suction Tubes	NEU-129
Dissectors	NEU-11	Punches	NEU-63	Test Instruments	NEU-134
Drills	NEU-17	Pushers	NEU-64	Transsphenoidal Instruments	NEU-134
Elevators	NEU-21	Rasps	NEU-64	Trephines	NEU-137
Enucleators	NEU-27	Retractors	NEU-64		
Forceps	NEU-28	Rongeurs	NEU-85		
Hooks	NEU-43	Saws	NEU-110		
Knife Handles	NEU-53	Scissors	NEU-113		
Knives	NEU-54	Scoops	NEU-121		
Ligature Instruments	NEU-56	Separators	NEU-121		

Questions? Contact us at customerservice@symmetrysurgical.com or learn more at symmetrysurgical.com



The Surgical Instrument Desk Reference

How to Use Our Catalog

The Symmetry Surgical catalog is designed with you in mind, to be your trusted resource for surgical instrumentation. We took great care in creating an easy-to-use, robust catalog and we think you'll be pleased with the design as you become more familiar with our broad portfolio.

Layout

The catalog is organized by surgical specialty *and* product function.

And we know that it is difficult to pick up an instrument and know what specialty it's listed in. To make your job easier, we've sorted the instruments in our portfolio by surgical function, too, including Energy, Laparoscopic, Retractors and Sterilization Solutions.

U.S. Customer Service

Your Symmetry Surgical Customer Service team wants to make ordering surgical instruments the easiest part of your day. We accept orders via phone, fax, email, our website, Global Healthcare Exchange (GHX) and through the mail.

PHONE

1.800.251.3000

(Available Monday through Friday, 8:30 AM–6:30 PM EST)

FAX

1.800.342.3272

EMAIL

customerservice@symmetrysurgical.com

ONLINE

symmetrysurgical.com

MAILING ADDRESS

Symmetry Surgical
Attn: Customer Service
3034 Owen Drive
Antioch, TN 37013

The Surgical Instrument Desk Reference

International Customer Service

PHONE

Symmetry Surgical Switzerland GmbH
+41 (0) 52 557 59 00
(Available Monday through Friday, 7:00-16:00 GMT)

Symmetry Surgical, Inc., USA
1.615.964.5672
(Available Monday through Friday, 8:30 AM–6:30 PM EST)

FAX

Symmetry Surgical Switzerland GmbH
+41 (0) 52 557 59 99

EMAIL

customerservice@symmetrysurgical.com
internationalorders@symmetrysurgical.com

ONLINE

symmetrysurgical.com

MAILING ADDRESS

Symmetry Surgical Switzerland GmbH
Bühlstrasse 27
CH-8200 Schaffhausen
Switzerland

Symmetry Surgical, Inc.
3034 Owen Drive
Antioch, TN 37013

INTERNATIONAL PAYMENT TERMS/RETURN GOODS POLICY/INSTRUMENT REPAIR & RESTORE PROGRAM/LITERATURE REQUESTS

Please contact your local distributor. Locate a local distributor contact, International Customer Service at +41 (0) 52 557 59 00 or 1.615.964.5672 (US).

Cardiovascular/Thoracic

Energy

Ear, Nose & Throat

General

Laparoscopic

Neurology

Obesity

OB/GYN

Ophthalmology

Orthopedics & Arthroscopy

Pediatrics

Rectal

Retractors

Spine

Urology

Sterilization Solutions

Alphabetical & Numeric Indexes

Blades (Temporary Clip)

Temporary Clip Blade

Slight Curve

CODE	DESCRIPTION	LENGTH
58-5078	9 mm, Opening	8 in 203 mm



Calipers

Neuro Caliper

CODE	DESCRIPTION	LENGTH
57-6050	Caliper	9¼ in 235 mm

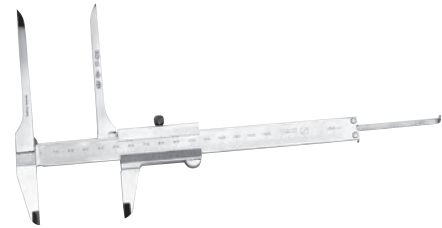

Cannulas

Frazier Brain Cannula

CODE	DIAMETER	LENGTH
57-3902	2.0 mm	4 in 102 mm
57-3904	3.0 mm	4 in 102 mm



57-3904

Clips (Aneurysm)

Micro Aneurysm Clip

9.0 mm

CODE	DESCRIPTION
58-5009	Straight
58-5019	Angled
58-5029	Slight Curve
58-5039	Strong Curve



58-5019

Clips (Aneurysm)

Raney Clip Applier

CODE	DESCRIPTION
57-8505	Clip Applier



Containers (Micro Instruments)



80-1564

Microcare Bayonet Case

Removable Lid

CODE	DESCRIPTION	LENGTH	
80-1564	Small	10 ½ in	267 mm
80-1565	Large	15 in	381 mm

Containers (Micro Instruments)



Microcare Combo Instrument Case

Designed to hold both Straight and Bayonet Instruments

CODE	DESCRIPTION	LENGTH
80-1567	Combo Instrument Case	15 in 381 mm



Microcare Instrument Case

Designed to hold straight instruments

CODE	DESCRIPTION	WIDTH	DEPTH	LENGTH
80-1563	Instrument Case	10 in 254 mm	1¼ in 32 mm	10½ in 267 mm



Microcare Universal Bayonet Instrument Case

CODE	DESCRIPTION	WIDTH	DEPTH	LENGTH
80-1914	Instrument Case	13 in 330 mm	1½ in 38 mm	21 in 533 mm

Containers (Micro Instruments)

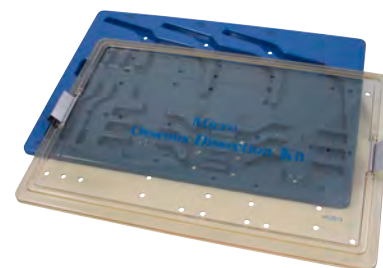

Osseous Dissection Instruments Sterilizing Case

CODE	DESCRIPTION
46-2613	Instruments Sterilizing Case



Rhoton® Sterilizing Carrying Case

CODE	DESCRIPTION
80-1661	Sterilizing Carrying Case

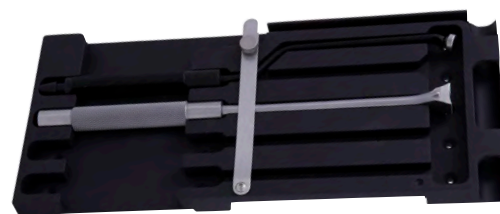

Sterilizing O.R. Display Case

CODE	DESCRIPTION	DIMENSIONS
46-3003	Holds instrument set: 46-3002 (Instruments Sold Separately)	10 x 4 ½ in 254 x 107 mm



Hudson Sterilizing Case

CODE	DESCRIPTION
21-1002C	For use with instrument set: 26-1075

Containers



Hardy™ Instrument Case with Removable Panels

CODE	DESCRIPTION	WIDTH		DEPTH			
80-1355	Instrument Case	7 in	178 mm	2¼ in	57 mm	11 in	279 mm

Cords (Air Hoses)

Air Hose

CODE	DESCRIPTION	LENGTH	
26-5007	Air Hose	10 ft	3 m



Curettes

Bruns Curette

Hexagonal Handle

CODE	SIZE	CUP SIZE	LENGTH	
32-3400	000	3.2 mm	9 in	229 mm
32-3401	00	3.4 mm	9 in	229 mm
32-3402	0	3.7 mm	9 in	229 mm
32-3403	1	4.7 mm	9 in	229 mm
32-3404	2	5.7 mm	9 in	229 mm
32-3405	3	7.0 mm	9 in	229 mm
32-3406	4	8.4 mm	9 in	229 mm
32-3407	5	8.9 mm	9 in	229 mm
32-3408	6	10.2 mm	9 in	229 mm



32-3402

Curettes



32-3479



32-3489



32-3499

Bruns Curette

Hollow Handle

CODE	SIZE	ANGLE	CUP SIZE	LENGTH
32-3470	0000	Straight	3.0 mm	9 in 229 mm
32-3480	0000	Forward Angle	3.0 mm	9 in 229 mm
32-3490	0000	Reverse Angle	3.0 mm	9 in 229 mm
32-3471	000	Straight	3.2 mm	9 in 229 mm
32-3481	000	Forward Angle	3.3 mm	9 in 229 mm
32-3491	000	Reverse Angle	3.2 mm	9 in 229 mm
32-3472	00	Straight	3.4 mm	9 in 229 mm
32-3482	00	Forward Angle	3.9 mm	9 in 229 mm
32-3492	00	Reverse Angle	3.4 mm	9 in 229 mm
32-3473	0	Straight	3.7 mm	9 in 229 mm
32-3483	0	Forward Angle	4.5 mm	9 in 229 mm
32-3493	0	Reverse Angle	3.7 mm	9 in 229 mm
32-3474	1	Straight	4.7 mm	9 in 229 mm
32-3484	1	Forward Angle	5.3 mm	9 in 229 mm
32-3494	1	Reverse Angle	4.5 mm	9 in 229 mm
32-3475	2	Straight	5.7 mm	9 in 229 mm
32-3485	2	Forward Angle	6.0 mm	9 in 229 mm
32-3495	2	Reverse Angle	5.7 mm	9 in 229 mm
32-3476	3	Straight	7.0 mm	9 in 229 mm
32-3486	3	Forward Angle	7.2 mm	9 in 229 mm
32-3496	3	Reverse Angle	7.0 mm	9 in 229 mm
32-3477	4	Straight	8.4 mm	9 in 229 mm
32-3487	4	Forward Angle	8.2 mm	9 in 229 mm
32-3497	4	Reverse Angle	8.4 mm	9 in 229 mm
32-3478	5	Straight	8.9 mm	9 in 229 mm
32-3488	5	Forward Angle	9.8 mm	9 in 229 mm
32-3498	5	Reverse Angle	8.9 mm	9 in 229 mm
32-3479	6	Straight	10.2 mm	9 in 229 mm
32-3489	6	Forward Angle	12.5 mm	9 in 229 mm
32-3499	6	Reverse Angle	10.2 mm	9 in 229 mm

Curettes

Epstein Curette

CODE	DESCRIPTION	LENGTH
57-4624	#00	10 in 254 mm



Karlin™ Cervical Curette

Working Distance 4.1 in (104 mm), Handle Width 0.6 in (15 mm)

CODE	SIZE/DESCRIPTION	ANGLE	LENGTH
46-2629	XL 0000	Forward Straight	9½ in 241 mm
46-2639	XL 0000	Backward Straight	9½ in 241 mm
46-2634	XL 0000	Forward Angle	9½ in 241 mm
46-2644	XL 0000	Backward Angle	9½ in 241 mm
46-2628	XL 000	Forward Straight	9½ in 241 mm
46-2638	XL 000	Backward Straight	9½ in 241 mm
46-2633	XL 000	Forward Angle	9½ in 241 mm
46-2643	XL 000	Backward Angle	9½ in 241 mm
46-2627	XL 00	Forward Straight	9½ in 241 mm
46-2637	XL 00	Backward Straight	9½ in 241 mm
46-2632	XL 00	Forward Angle	9½ in 241 mm
46-2642	XL 00	Backward Angle	9½ in 241 mm
46-2626	XL 0	Forward Straight	9½ in 241 mm
46-2636	XL 0	Backward Straight	9½ in 241 mm
46-2631	XL 0	Forward Angle	9½ in 241 mm
46-2641	XL 0	Backward Angle	9½ in 241 mm



Caspar Curette

Square Handle

CODE	DESCRIPTION	TIP SIZE	LENGTH
32-3410	Reverse	4.0 mm	9¾ in 248 mm
32-3411	Reverse	5.0 mm	9¾ in 248 mm



Curettes

Micro Curette

Bayonet, Working Distance 3 in (76 mm)

CODE	SIZE	ANGLE
46-2606	0000	Straight
46-2609	0000	45° Up
46-2612	0000	80° Down
46-2605	000	Straight
46-2608	000	45° Up
46-2611	000	80° Down
46-2607	00	45° Up
46-2610	00	80° Down



46-2607

Yasargil Micro Curette

CODE	DESCRIPTION	LENGTH
58-3309	Oval Cup	7 ¼ in 184 mm

Curettes (Micro Pituitary)

Nicola Micro Pituitary Curette

Malleable, 6.5 mm Ring

CODE	DESCRIPTION	LENGTH
58-3550	Straight	8 ¼ in 210 mm
58-3548	Left-Cutting	8 ¼ in 210 mm



58-3548

Curettes (Pituitary)

Fahlbusch Pituitary Curette

CODE	CUP	LENGTH
58-3627	2.5 mm	10 ¼ in 260 mm



Curettes

Ray Pituitary Curette

CODE	ANGLE	WIDTH	LENGTH
57-4803	45°	3.0 mm	7½ in 191 mm
57-4805	45°	5.0 mm	7½ in 191 mm
57-4823	45° Angled to Side	3.0 mm	7½ in 191 mm
57-4825	45° Angled to Side	5.0 mm	7½ in 191 mm
57-4813	90°	3.0 mm	7½ in 191 mm
57-4815	90°	5.0 mm	7½ in 191 mm
57-4833	90° Angled to Side	3.0 mm	7½ in 191 mm
57-4835	90° Angled to Side	5.0 mm	7½ in 191 mm

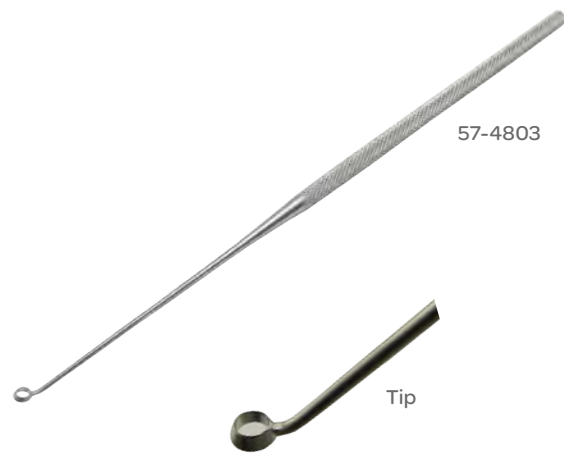

Cone Ring Curette

Straight

CODE	SIZE	RING I.D.	LENGTH
23-1013	#1	5/16 in 8.0 mm	9 in 229 mm
23-1014	#2	1/4 in 6.0 mm	9 in 229 mm
23-1015	#3	1/8 in 3.0 mm	9 in 229 mm



Curettes (Transsphenoidal)

Hardy™ Curette

Bayonet

CODE	DESCRIPTION	TIP WIDTH	WORKING DISTANCE	LENGTH
80-1347	45° Right	3.0 mm	4¾ in 121 mm	9¼ in 235 mm
80-1334	45° Right	5.0 mm	4¾ in 121 mm	9¼ in 235 mm
80-1348	90° Left	3.0 mm	4¾ in 121 mm	9¼ in 235 mm
80-1333	90° Left	5.0 mm	4¾ in 121 mm	9¼ in 235 mm
80-1345	Angled Down	3.0 mm	4¾ in 121 mm	9¼ in 235 mm
80-1330	Angled Down	5.0 mm	4¾ in 121 mm	9¼ in 235 mm
80-1346	Angled Up	3.0 mm	4¾ in 121 mm	9¼ in 235 mm
80-1331	Angled Up	5.0 mm	4¾ in 121 mm	9¼ in 235 mm
80-1335	Curved Left	3.0 mm	4¾ in 121 mm	9¼ in 235 mm
80-1332	Curved Right	5.0 mm	4¾ in 121 mm	9¼ in 235 mm



Curettes

Malis® Curette

Stainless Steel Shaft, Titanium Handle

CODE	DESCRIPTION	WORKING DISTANCE	LENGTH
80-1536	Bayonet	4 in (102 mm)	8 in 203 mm



Dissectors (Ball)

Rhoton® Ball Dissector

CODE	DESCRIPTION	WIDTH	LENGTH
58-6072	45° Angle	4.0 mm	7½ in 191 mm



Dissectors (Cherry)

Cherry Secto® Dissector

Dispenser Includes: 96 Packages of 5 Each, Four Dispensers per Case

CODE	DESCRIPTION	DIAMETER
81-1002	Sterile, X-Ray Detectable	⅜ in 10 mm
81-1006	Triangle	½ in 13 mm

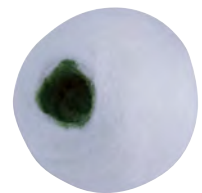

81-1002

Dissectors (Disc)

Disc Dissector

CODE	DESCRIPTION	LENGTH
80-2078	2.5 mm, Round	



Dissectors

Olivecrona Double-Ended Dissector

CODE	WIDTH	LENGTH
57-3601	2.0x3.0 mm	7 in 178 mm
57-3604	4.0x5.0 mm	9½ in 241 mm



57-3601

Milligan Dissector

CODE	DESCRIPTION	TIP SIZE	LENGTH
65-1038	Double-Ended	14 mm and 16 mm	8½ in 216 mm



Kitner Secto® Dissector

480 Per Kit

CODE	DESCRIPTION	DIAMETER
81-1001	Sterile, X-Ray Detectable	⅝ in 8 mm

Penfield MagnaFree® Dissector

CODE	DESCRIPTION	LENGTH
65-2402	#1, Broad Curved Dissector, and Sharp Round Spoon	7 in 178 mm
65-2403	#2, Slightly Curved Dissector, and Wax Packer	7¾ in 197 mm
65-2404	#3, Fully Curved Dissector, and Wax Packer	7¾ in 197 mm
65-2405	#4, Slightly Curved Dissector, Light Length	8¼ in 210 mm

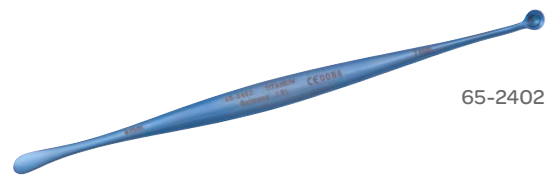

65-2402

Dissectors

Caspar Micro Dissector

CODE	DESCRIPTION	BLADE	LENGTH	
58-3323	Curved Up, Bayonet Shaft	1.0 mm	8¼ in	210 mm
58-3325	Curved Down, Bayonet Shaft	2.0 mm	9 in	229 mm
58-3327	Curved Down, Straight Shaft	4.5 mm	9 in	229 mm



Yasargil Micro Dissector

CODE	DESCRIPTION	LENGTH
58-3015	Angled, Pointed Blade, 2.5 mm Wide	7¼ in 184 mm

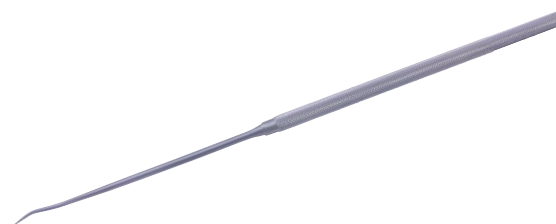

Jannetta Neck Dissector

CODE	DESCRIPTION	LENGTH
58-6214	Angled 30°, Right	7½ in 191 mm

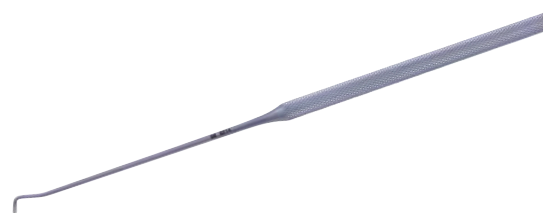

Smithwick Neck Hook Dissector

CODE	DESCRIPTION	HOOK LENGTH	LENGTH	
38-1088	Double-Ended, Blunt	⅞ in 11 mm	12 in	305 mm

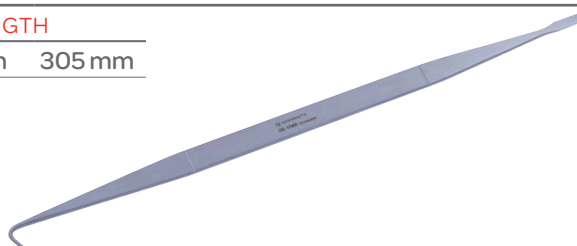

Dissectors (Neurovascular)

Spetzler Neurovascular Dissector

Titanium, Bayonet

CODE	DESCRIPTION	WORKING DISTANCE	LENGTH
80-1900	30° Angled Up, Small Teardrop	4 in 102 mm	9½ in 241 mm
80-1902	30° Angled Up, Small Spatula	4 in 102 mm	9½ in 241 mm
80-1901	90° Angled Up, Small Teardrop	4 in 102 mm	9½ in 241 mm

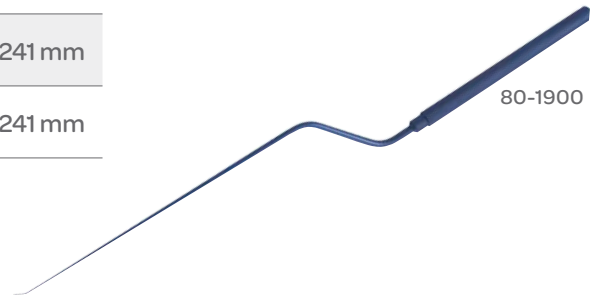

Dissectors (Peanut)

Peanut Secto® Dissector

Dispenser Includes: 96 Packages of 5 Each, Four Dispensers per Case

CODE	DESCRIPTION	DIAMETER	LENGTH
81-1000	X-Ray Detectable	⅜ in 10 mm	8¾ in 222 mm



Dissectors (Teardrop)

Apfelbaum Tear Drop Dissector

CODE	ANGLE	LENGTH
58-6260	45°	8¾ in 222 mm



Dissectors (Transsphenoidal)

Hardy™ Micro Dissector

Bayonet

CODE	DESCRIPTION	WORKING DISTANCE	LENGTH
80-1316	Angled Down	4 ³ / ₄ in 121 mm	9 ¹ / ₄ in 235 mm
80-1315	Angled Up	4 ³ / ₄ in 121 mm	9 ¹ / ₄ in 235 mm



80-1316

Dissectors (Triangle)

Triangle Secto® Dissector

Dispenser Includes: 96 Packages of 5 Each, Four Dispensers per Case, 480 per Box, Sterile

CODE	DESCRIPTION	DIAMETER
81-1006	X-Ray Detectable	¹ / ₂ in 13 mm



Dissectors

Jannetta Dissector

CODE	DESCRIPTION	LENGTH
58-6205	Curved Small	7 ¹ / ₂ in 191 mm

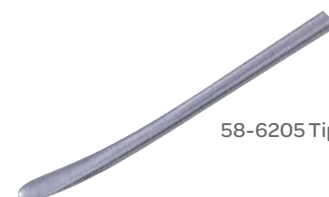

58-6205 Tip

Malis® Dissector

Angled, Stainless Steel Handle, Titanium Handle

CODE	DESCRIPTION	TIP WIDTH	LENGTH
80-1535	Curved Edge, Semi-Sharp	3.2 mm	7 ³ / ₈ in 187 mm
80-1539	Sharp on Three Sides	1.3 mm	7 ³ / ₈ in 187 mm
80-1541	Round	1.0 mm	7 ³ / ₈ in 187 mm
80-1540	Round	2.0 mm	7 ³ / ₈ in 187 mm
80-1542	Round	3.5 mm	7 ³ / ₈ in 187 mm

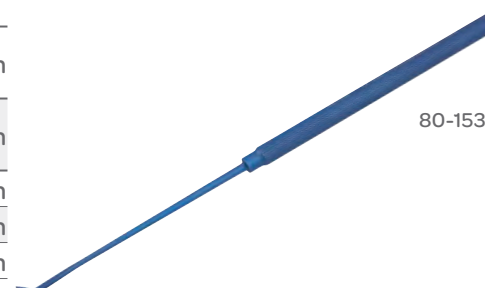

80-1535

Dissectors

Penfield Dissector

CODE	SIZE	DESCRIPTION	LENGTH	
65-1015	#1	Broad Curved Dissector and Sharp Round Spoon	7 in	178 mm
57-3651	#1	Broad Curved Dissector and Sharp Round Spoon	7 1/8 in	181 mm
65-1016	#2	Slightly Curved Dissector and Wax Packer	7 3/4 in	197 mm
57-3652	#2	Slightly Curved Dissector and Wax Packer	8 in	203 mm
65-1017	#3	Fully Curved Dissector and Wax Packer	7 3/4 in	197 mm
57-3653	#3	Fully Curved Dissector and Wax Packer	8 in	203 mm
57-3654	#4	Single-Ended, Round Handle	8 1/2 in	216 mm
65-1018	#4	Slightly Curved Dissector, Light	8 1/4 in	210 mm
65-1019	#5	Double-Ended	11 1/2 in	292 mm



57-3651



80-1660

Rhoton® Micro Dissector Set

CODE	SIZE	DESCRIPTION	ETCHED LABEL	TIP WIDTH	LENGTH
80-1660	Contains 1 each of the following:				
80-1680	Rhoton® Dissector	Small	#1	1.3 mm	7 1/2 in 191 mm
80-1681	Rhoton® Dissector	Medium	#2	2.3 mm	7 1/2 in 191 mm
80-1682	Rhoton® Dissector	Large	#3	3.3 mm	7 1/2 in 191 mm
80-1683	Rhoton® General Purpose Elevator	Small	#4		7 1/2 in 191 mm
80-1684	Rhoton® General Purpose Elevator	Large	#5		7 1/2 in 191 mm
80-1685	Rhoton® Spatula Dissector	Small	#6	1.1 mm	7 1/2 in 191 mm
80-1686	Rhoton® Spatula Dissector	Medium	#7	1.7 mm	7 1/2 in 191 mm
80-1687	Rhoton® Spatula Dissector	Large	#8	2.1 mm	7 1/2 in 191 mm
80-1688	Rhoton® Semi-Sharp Hook	90°	#9		7 1/2 in 191 mm
80-1689	Rhoton® Blunt Hook	90°	#10		7 1/2 in 191 mm
80-1690	Rhoton® Semi-Sharp Hook	40°	#11		7 1/2 in 191 mm
80-1691	Rhoton® Needle Point, Sharp	Straight	#12		7 1/2 in 191 mm
80-1692	Rhoton® Curette	Small	#13	1.6 mm	7 1/2 in 191 mm
80-1693	Rhoton® Curette	Large	#14	1.4 mm	7 1/2 in 191 mm
80-1679	Rhoton® Teardrop Dissector	Straight	#15	3.0 mm	7 1/2 in 191 mm
80-1696	Rhoton® Teardrop Dissector	90°	#16	3.0 mm	7 1/2 in 191 mm
80-1697	Rhoton® Teardrop Dissector	90°	#17	5.0 mm	7 1/2 in 191 mm
80-1698	Rhoton® Teardrop Dissector	40°	#18	4.0 mm	7 1/2 in 191 mm
80-1699	Rhoton® Teardrop Dissector	40°	#19	8.0 mm	7 1/2 in 191 mm
80-1661	Rhoton® Set Instrument Case				

Dissectors

Rhoton® Spatula Dissector

Straight, Titanium

CODE	DESCRIPTION	LENGTH
58-6020T	Small	7½ in 191 mm
58-6021T	Medium	7½ in 191 mm
58-6022T	Large	7½ in 191 mm

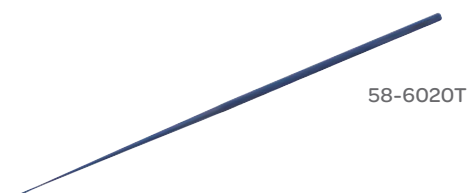

58-6020T

Drills (Burrs)

Cushing Burr

CODE	DIAMETER	LENGTH
15-1000C	⅜ in 10 mm	3½ in 89 mm



Drills (Burr Set)



26-1075

Hudson Cranial Drill Set

CODE	SIZE	DIAMETER	LENGTH
26-1075	Hudson Cranial Drill Set Consists of the Items Below:		
15-1005	Hudson Burr	⅜ in 10 mm	4 in 102 mm
15-1006	Hudson Burr	⅞ in 14 mm	4 in 102 mm
15-1007	Hudson Burr	⅝ in 16 mm	4 in 102 mm
15-1008	Hudson Burr	⅞ in 22 mm	4 in 102 mm
80-1002	Cerebellar Extension		
26-1041	Brace		
21-1002	Hudson Cranial Drill Set Case		

Drills (Cerebellar)

Hudson Cerebellar Extension

CODE	DESCRIPTION
80-1002	Cerebellar Extension



Drills (Cervical Tip)

Cervical Drill Tip

CODE	DESCRIPTION
26-1265	10 mm
26-1266	12 mm
26-1267	14 mm
26-1268	16 mm



26-1265

Drills (Cranial)

Hudson Cranial Drill

CODE	DESCRIPTION	LENGTH
57-6004	Brace Only, Standard Thumb Lock	10 1/2 in 267 mm
57-6000	Cranial Drill	

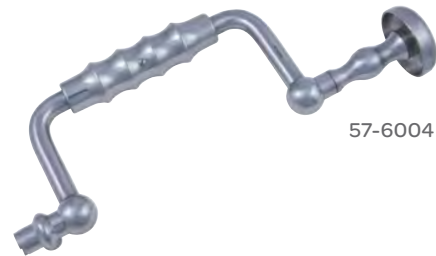

57-6004

Drills (Crossbar Handle)

Crossbar Handle

CODE	DESCRIPTION
11-1002	Crossbar Handle



Drills

Mathews Drill Point

CODE	DIAMETER	LENGTH
26-1181	6.0 mm	1 $\frac{7}{8}$ in 48 mm

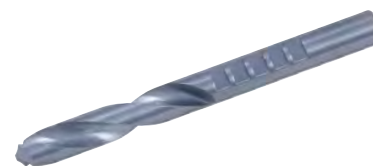

Mckenzie Enlarging Burr

CODE	DIAMETER	LENGTH
15-1004	1 $\frac{1}{16}$ in 27 mm	5 in 127 mm



Drills (Guard Cap)

Drill Guard Cap

CODE	DIAMETER	LENGTH
12-1007	1 in 25 mm	1 $\frac{1}{4}$ in 32 mm



Drills (Guide & Dura Protector)

Adson Drill Guide & Dura Protector

Angled on Side, With Hole in Jaw

CODE	JAW LENGTH	HOLE DIAMETER	LENGTH
14-1000	$\frac{3}{4}$ in 19 mm	$\frac{1}{8}$ in 3.0 mm	6 in 152 mm



Drills (Hand-Operated)

Bunnell Hand Drill

CODE	DESCRIPTION	LENGTH
26-1080	With Jacobs Chuck	$\frac{5}{32}$ in 4.0 mm



Drills (Perforator)

Cushing Perforator Drill

CODE	DIAMETER	LENGTH
26-1000	$\frac{3}{8}$ in 9.0 mm	4 in 102 mm
26-1001	$\frac{1}{2}$ in 13 mm	4 in 102 mm
26-1002	$\frac{5}{8}$ in 16 mm	4 in 102 mm



26-1000

D'Errico Perforator Drill & Enlarging Burr

CODE	DESCRIPTION	LENGTH
26-1006	Drill and Enlarging Burr	$3\frac{5}{8}$ in 92 mm



Mckenzie Perforator Drill

High Speed Steel

CODE	DIAMETER	LENGTH
26-1004	$\frac{1}{2}$ in 13 mm	4 in 102 mm

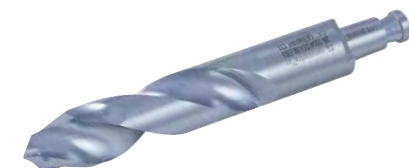

Drills (Perforator)

Raney Perforator Drill

With Adjustable Depth Guard

CODE	DIAMETER	LENGTH
26-1008	½ in 13 mm	4 in 102 mm



Drills (Shaft)

Drill Shaft

CODE	DESCRIPTION	LENGTH
28-1002	Large (16 mm)	5 9/16 in 141 mm
28-1001	Small (13 mm)	5 9/16 in 141 mm



Elevators

Jannetta Angled Elevator

CODE	DESCRIPTION	LENGTH
58-6204	Angled Elevator	7 ½ in 191 mm



Jannetta Duckbill Elevator

CODE	DESCRIPTION	LENGTH
58-6203	Duckbill Elevator	7 ½ in 191 mm



Elevators

Rhoton® General Purpose Elevator

CODE	DESCRIPTION	LENGTH
80-1684	#5, Titanium, Large, Curved, Blunt	7½ in 191 mm
80-1683	#4, Titanium, Small, Straight, Blunt	7½ in 191 mm
58-6011	Angled Tip	7½ in 191 mm



80-1684

Woodson MagnaFree® Elevator & Spatula

Double-Ended, Semi-Sharp

CODE	BLADE W X L X D	LENGTH
65-2423	⅛ x 7½ x ½ in (3.0 x 191 x 13 mm)	10 in 254 mm



Elevators (Periosteal)

Adson Elevator

Curved

CODE	DESCRIPTION	BLADE WIDTH	LENGTH
65-1031	#2, Blunt Edge	¼ in 6.0 mm	6½ in 165 mm
65-1032	#3, Semi-Sharp Edge	¼ in 6.0 mm	6½ in 165 mm

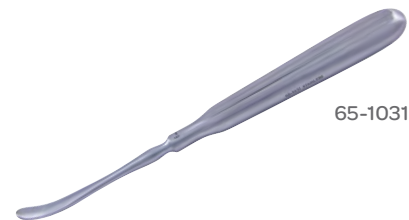

65-1031

Carroll Periosteal Elevator

Double-Ended

CODE	BLADE WIDTH	LENGTH
65-2549	⅛ in (3 mm) and ⅜ in (10 mm)	5½ in 140 mm



Elevators (Periosteal)

Cloward Osteophyte Periosteal Elevator

CODE	DESCRIPTION	LENGTH
57-5038	90° Tip	8 in 203 mm



Cushing "Little Joker" Periosteal Elevator

CODE	DESCRIPTION	BLADE WIDTH	LENGTH
65-1047	Hollow Handle	¼ in 6.0 mm	6 in 152 mm
65-1048	Solid Handle	¼ in 6.0 mm	7½ in 191 mm



65-1047

Cushing Periosteal Elevator

Sharp

CODE	DESCRIPTION	BLADE WIDTH	LENGTH
65-1075	Rounded Edge	5/8 in 16 mm	7¼ in 184 mm
65-1076	Square Edge	5/8 in 16 mm	7¼ in 184 mm
65-1050	Narrow	¼ in 6.0 mm	8⅞ in 206 mm

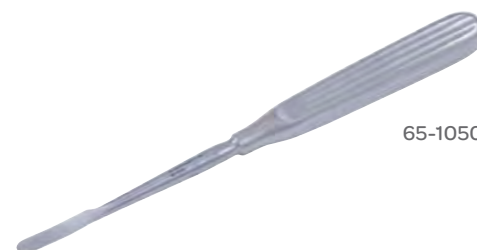

65-1050

Hoehn Periosteal Elevator

CODE	SIZE	BLADE WIDTH	LENGTH
65-1001	#1	5/16 in 8 mm	7 in 178 mm
65-1003	#1	3/4 in 20 mm	7½ in 191 mm
65-1002	#2	5/8 in 15 mm	7¼ in 184 mm



65-1002

Elevators (Periosteal)

Iowa University Periosteal Elevator

CODE	BLADE WIDTH		LENGTH	
65-1080	1 $\frac{1}{16}$ in	17 mm	7 $\frac{1}{4}$ in	184 mm



Key Periosteal Elevator

CODE	BLADE WIDTH		LENGTH	
65-2510	$\frac{1}{4}$ in	6.0 mm	7 $\frac{1}{2}$ in	191 mm
65-2511	$\frac{3}{8}$ in	10 mm	7 $\frac{1}{2}$ in	191 mm
65-2512	$\frac{1}{2}$ in	13 mm	7 $\frac{1}{2}$ in	191 mm
65-2513	$\frac{3}{4}$ in	19 mm	7 $\frac{1}{2}$ in	191 mm
65-2514	1 in	25 mm	7 $\frac{1}{2}$ in	191 mm



Langenbeck Periosteal Elevator

CODE	DESCRIPTION	BLADE WIDTH		LENGTH	
65-1115	Narrow	$\frac{1}{4}$ in	6.0 mm	8 $\frac{1}{4}$ in	210 mm
65-1116	Wide	1 $\frac{1}{16}$ in	17 mm	7 $\frac{1}{2}$ in	191 mm



Love-Adson Periosteal Elevator

CODE	DESCRIPTION	BLADE WIDTH		LENGTH	
65-1110	Semi-Sharp	$\frac{3}{16}$ in	5.0 mm	6 $\frac{1}{2}$ in	165 mm



Elevators (Periosteal)

Molt Periosteal Elevator

CODE	DESCRIPTION	LENGTH
32-3420	#9	7¼ in 184 mm



Osteophyte Periosteal Elevator

CODE	DESCRIPTION	LENGTH
65-1064	Periosteal Elevator	8 in 203 mm



Periosteal Elevator

CODE	DESCRIPTION	LENGTH
65-1056	#1	8 in 203 mm
65-1057	#2	8 in 203 mm
65-1058	#3	8 in 203 mm



Sharp Elevator

CODE	DESCRIPTION	WIDTH
65-1121	Curved	5 mm



Elevators

Cushing Staphylorrhaphy Elevator

Round Handle

CODE	BLADE WIDTH	LENGTH
65-1045	$\frac{7}{16}$ in 11 mm	8½ in 216 mm

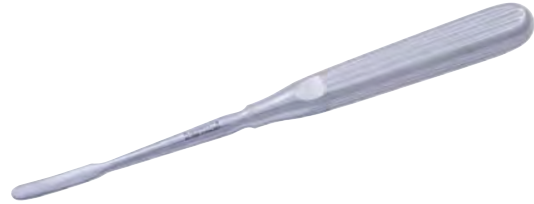

Presbyterian Hospital Staphylorrhaphy Elevator

Double-Ended

CODE	DESCRIPTION	LENGTH
65-1006	Curved, Semi-Sharp and Sharp Blades	7 in 178 mm



Malis® Elevator

CODE	DESCRIPTION	LENGTH
80-1537	Curved Stainless Steel Shafts, Curved Tip, Titanium Handles, Width 3.5 mm	7¼ in 184 mm
57-5780	Bayonet	8 in 203 mm



Presbyterian Hospital Elevator

CODE	DESCRIPTION	LENGTH
57-3512	Straight	7 in 178 mm



Elevators

Rhoton® Elevator

Titanium

CODE	DESCRIPTION	LENGTH
58-6010T	Curved Tip	7½ in 191 mm

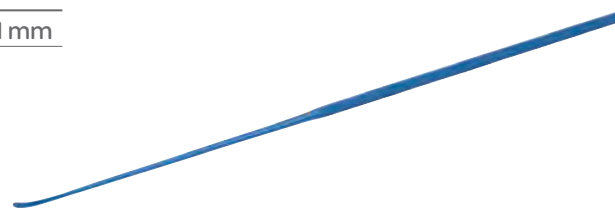

Woodson Elevator

CODE	DESCRIPTION	LENGTH
57-3515	Double-Ended	7⅞ in 181 mm
57-3517	Double-Ended	10 in 250 mm



Woodson Elevator-Spatula

CODE	DESCRIPTION	BLADE SIZE W X D X L
59-1000	Semi-Sharp, Double-Ended	⅛ x ½ x 10 in 3.0 x 13 x 254 mm

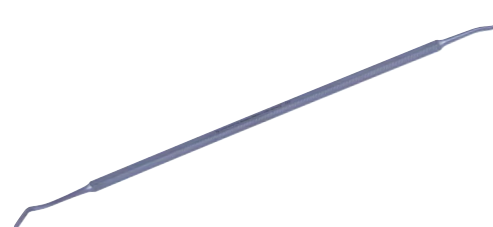

Enucleators (Transsphenoidal)

Hardy™ Enucleator

CODE	DESCRIPTION	TIP WIDTH	LENGTH
80-1311	Left, Micro	2.4 mm	9¼ in 235 mm
80-1325	Left	2.6 mm	9¼ in 235 mm
80-1312	Right, Micro	2.4 mm	9¼ in 235 mm
80-1326	Right	2.6 mm	9¼ in 235 mm
80-1329	Reverse Curve	2.6 mm	9¼ in 235 mm



Enucleators (Transsphenoidal)

Hardy™ Enucleator

Bayonet

CODE	DESCRIPTION	WORKING DISTANCE	LENGTH
80-1328	Three Prong	3½ in 89 mm	8⅛ in 205 mm



Hardy™ Transsphenoidal Bayonet Enucleator

Standard

CODE	DESCRIPTION	LENGTH
58-7558	Left	9½ in 241 mm
58-7560	Right	9½ in 241 mm



Micro Transsphenoidal Enucleator

CODE	DESCRIPTION	LENGTH
57-3572	Left	9½ in 241 mm
57-3573	Right	9½ in 241 mm



Forceps (Alligator)

Hoen Alligator Forceps

1x2 Teeth

CODE	TIP WIDTH	SHAFT LENGTH
30-1230	2.2 mm	5½ in 140 mm



Forceps (Bayonet)

D'Errico Bayonet Forceps

CODE	DESCRIPTION	LENGTH
58-1547	Serrated	8 ³ / ₄ in 222 mm
58-1548	1x2 Teeth	8 ³ / ₄ in 222 mm



58-1547

Hoen Bayonet Forceps

CODE	DESCRIPTION	LENGTH
58-1550	Serrated	7 ⁵ / ₈ in 219 mm



Yasargil Bayonet Forceps

CODE	DESCRIPTION	LENGTH
59-2342M	Tip Angled Down 60°	8 ³ / ₄ in 220 mm
59-2342	Straight	8 ³ / ₄ in 220 mm
58-1544	Blunt Tips	9 ¹ / ₁₆ in 231 mm
58-1546	Sharp Tips	9 ¹ / ₁₆ in 231 mm

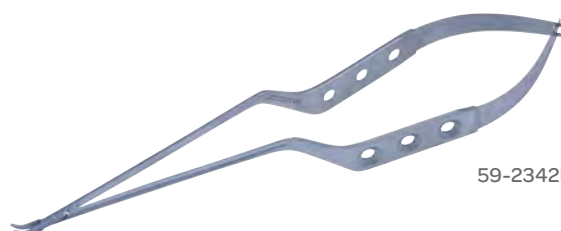

59-2342M

Forceps (Bone Cutting)

Horsley Bone Cutting Forceps

CODE	DESCRIPTION	LENGTH
30-1298	Double-Action, Curved Shaft, Angular Jaw	10 ¹ / ₂ in 267 mm

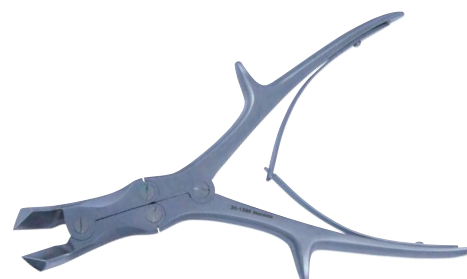

Forceps (Bone Cutting)

Liston Bone Cutting Forceps

CODE	DESCRIPTION	LENGTH
30-1310	Straight	5½in 140 mm



Ruskin Bone Cutting Forceps

CODE	DESCRIPTION	LENGTH
30-1290	Double-Action	7¼in 184 mm



Stille-Liston Bone Forceps

Double-Action

CODE	DESCRIPTION	LENGTH
30-1295	Straight	10½in 267 mm
30-1296	Curved	10½in 267 mm

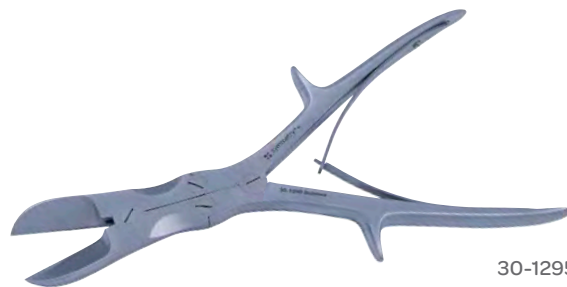

30-1295

Forceps (Brain Tumor)

Brigham Brain Tumor Forceps

CODE	RING JAW DIAMETER	LENGTH
30-1117	⅜in 10 mm	7⅜in 187 mm



Forceps (Cup)

Malis® Cup Forceps

Bayonet

CODE	DESCRIPTION	LENGTH
80-1527	Small Cup, 2.75 x 2.0 mm	8½ in 216 mm
80-1528	Medium Cup, 3.5 x 2.75 mm	8½ in 216 mm
80-1529	Large Cup, 4.75 x 3.50 mm	8½ in 216 mm



80-1527

Forceps (Dressing)

Adson Dressing Forceps

CODE	DESCRIPTION	TIP WIDTH	WORKING DISTANCE	LENGTH
30-4214	Delicate Tip	0.8 mm		5 in 127 mm
30-1185	Standard Tip	1.2 mm		5 in 127 mm
30-1190	Standard Tip	2 mm		7 in 178 mm
30-1191	Bayonet Shape	2 mm	3⅝ in 92 mm	7½ in 191 mm



30-1185

Cushing Dressing Forceps

Serrated Handle

CODE	DESCRIPTION	TIP WIDTH	WORKING DISTANCE	LENGTH
30-1150		1.5 mm		7 in 178 mm
30-1152	Extra Fine Tip	1.3 mm		7 in 178 mm
30-1154		1.8 mm		7¾ in 197 mm
30-1155	Bayonet Shape, Dissecting End	1.8 mm	3 in 76 mm	7¼ in 184 mm
30-1203	Bayonet Shape	2.1 mm	3¼ in 83 mm	8¾ in 248 mm

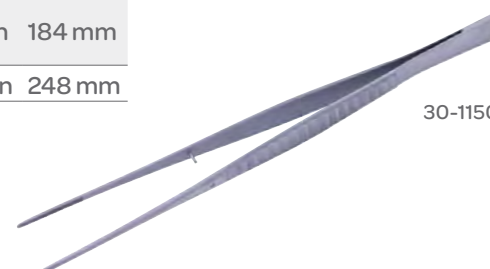

30-1150

Forceps (Dressing)

Gerald Dressing Forceps

Serrated

CODE	DESCRIPTION	TIP WIDTH	WORKING DISTANCE		LENGTH	
30-1214	Straight	1.1 mm			7 in	178 mm
30-1216	Bayonet Shape	1.3 mm	3 ½ in	89 mm	7 ½ in	191 mm



30-1214

Hoen Dressing Forceps

Serrated, Gutsch Handle

CODE	DESCRIPTION	TIP WIDTH	WORKING DISTANCE		LENGTH	
30-1165	Bayonet Shape	2.0 mm	3 in	76 mm	7 ¾ in	197 mm



Jansen Dressing Forceps

Serrated

CODE	DESCRIPTION	TIP WIDTH	WORKING DISTANCE		LENGTH	
30-1160	Bayonet	1.8 mm	4 ⅞ in	121 mm	8 ½ in	216 mm
30-6995	Bayonet	2.0 mm	3 ⅛ in	80 mm	6 ½ in	165 mm



30-1160

Rhoton® Dressing Forceps

Serrated

CODE	DESCRIPTION	TIP WIDTH	LENGTH	
80-1732	Titanium	1.8 mm	7 in	178 mm



Semken Dressing Forceps

CODE	DESCRIPTION	TIP WIDTH	LENGTH	
30-1180	Serrated	1.3 mm	5 in	127 mm



Forceps (Dural)

Rhoton® Dura Forceps

Titanium

CODE	DESCRIPTION	TIP WIDTH	LENGTH
80-1731	1x2 Teeth	1.0 mm	7 in 178 mm



Forceps (Hypophyseal)

Adson Hypophyseal Bayonet Forceps

CODE	DESCRIPTION	CUP	LENGTH
59-4410	Straight	6 mm	9 in 229 mm
59-4411	Curved Up	6 mm	9 in 229 mm

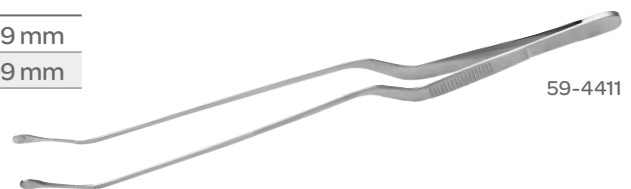

Adson Hypophyseal Forceps

Straight, Bayonet Shape

CODE	WORKING DISTANCE	CUP I.D.	LENGTH
30-1000	4½ in 114 mm	¼ in 6.0 mm	9 in 229 mm



Forceps (Micro)

Forceps

Titanium, Ring Tip, Straight

CODE	DESCRIPTION	TIP WIDTH	LENGTH
80-6001	Ring Tip	1.0 mm	6 in 152 mm
80-6002	Ring Tip, Serrated	1.0 mm	6 in 152 mm



Forceps (Micro)

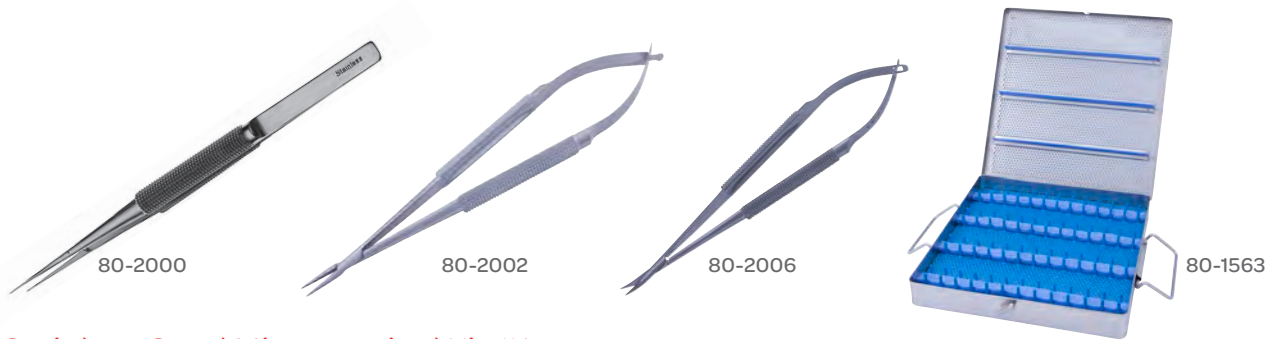

Stainless Steel Microsurgical Kit #1

CODE	DESCRIPTION	TIP WIDTH	QTY	LENGTH
80-2030	Stainless Steel Microsurgical Kit #1 (Includes Items Below)			5½ in 140 mm
80-2000	Micro Forceps, Straight	0.3 mm	2	5½ in 140 mm
80-2002	Needle Holder Straight	0.5 mm	1	5½ in 140 mm
80-2003	Needle Holder Curved	0.5 mm	1	5½ in 140 mm
80-2005	Micro Scissors Straight		1	5½ in 140 mm
80-2006	Micro Scissors Curved		1	5½ in 140 mm
80-1563	Microcare Instrument Case 10½ x 1¼ x 15 in (267 x 32 x 38 mm)			

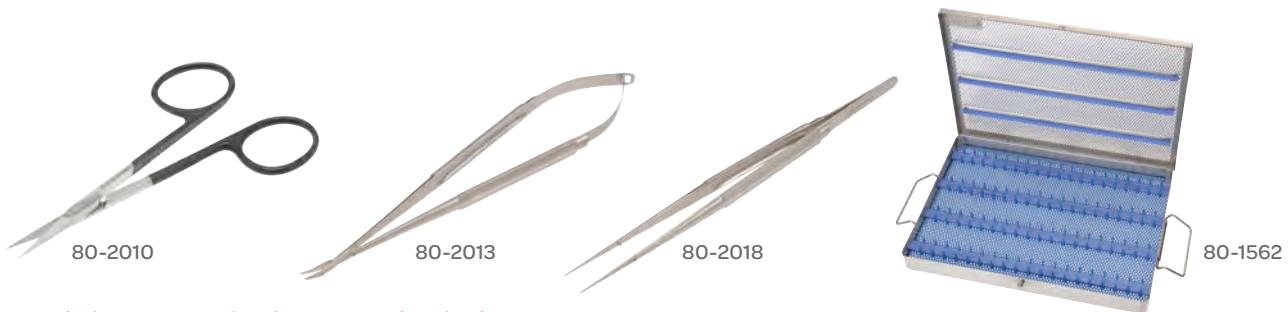

Stainless Steel Microsurgical Kit #2

CODE	DESCRIPTION	TIP WIDTH	LENGTH
80-2031	Stainless Steel Microsurgical Kit #2 (Includes one each of the Items Below)		7 in 178 mm
80-2009	Micro Forceps, Straight	0.3 mm	7 in 178 mm
80-2010	Micro Forceps, Straight	0.7 mm	7 in 178 mm
80-2012	Needle Holder Straight	0.5 mm	7 in 178 mm
80-2013	Needle Holder Curved	0.5 mm	7 in 178 mm
80-2015	Micro Scissors Straight		7 in 178 mm
80-2016	Micro Scissors Curved		7 in 178 mm
80-2018	Micro Tying Forceps Straight	0.7 mm	7 in 178 mm
80-2019	Micro Tying Forceps Curved	0.7 mm	7 in 178 mm
80-1562	Microcare Instrument Case 10½ x 1¼ x 15 in (267 x 32 x 38 mm)		

Forceps (Micro)

Micro Alligator Forceps

CODE	DESCRIPTION	JAW	SHAFT LENGTH	
58-4610	Straight	0.5 mm	5 in	140 mm
58-4613	Left	0.5 mm	5 in	140 mm
58-4602	Right	0.5 mm	5 in	140 mm

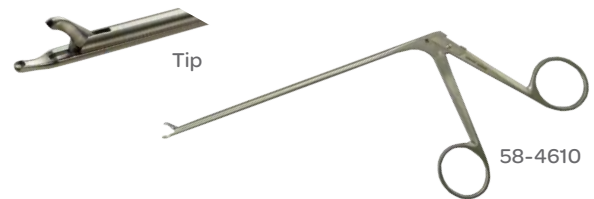

Yasargil Micro Bayonet Forceps

CODE	DESCRIPTION	LENGTH
58-1566	0.9 mm Tips	9½ in 241 mm



Rhoton® Micro Cup Forceps

Alligator Action

CODE	DESCRIPTION	TIP WIDTH	LENGTH	
53-4005	Straight	1.0 mm	6 in	152 mm
53-4008	Straight	2.0 mm	6 in	152 mm
53-4007	Left	1.0 mm	6 in	152 mm
53-4006	Right	1.0 mm	6 in	152 mm



Micro Cup Pituitary Forceps

Semi-Malleable

CODE	TIP WIDTH	LENGTH
53-4009	1.0 mm	7⅞ in 200 mm
53-4010	2 mm	7⅞ in 200 mm



Forceps (Micro)

Decker Microsurgical Forceps

Serrated Jaws

CODE	DESCRIPTION	TIP WIDTH	LENGTH
30-4856	Alligator Action	1.4 mm	6 in 152 mm



Forceps (Neurovascular)

Spetzler Neurovascular Forceps

Titanium, Bayonet

CODE	DESCRIPTION	WORKING DISTANCE		LENGTH	
80-1905	Straight Tip	4 in	100 mm	9½ in	241 mm
80-1906	30° Angled Tip	4 in	100 mm	9½ in	241 mm



80-1905

Forceps (Pituitary)

D'Errico Pituitary Forceps

Bayonet Shape

CODE	WORKING DISTANCE		C.U.P.I.D.		LENGTH	
30-1204	3½ in	89 mm	¼ in	6.0 mm	3½ in	89 mm

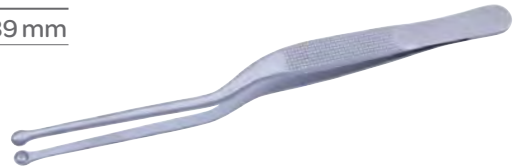

Forceps (Scalp)

Dandy Classic® Scalp Forceps

CODE	DESCRIPTION	TEETH	LENGTH
32-4160	Curved on Side, Bright Finish	Serrated	5½ in 140 mm
32-4161	Curved on Side, Bright Finish	Serrated, 1x2 Teeth	5½ in 140 mm



32-4161

Forceps (Scalp)

Dandy Classic® Scalp Forceps

CODE	DESCRIPTION	TEETH	LENGTH
33-4160	Curved on Side, Mirror Finish	Serrated	5 ½ in 140 mm
33-4161	Curved on Side, Mirror Finish	1 x 2 Teeth	5 ½ in 140 mm
34-4160	Curved on Side	Serrated	5 ½ in 140 mm
34-4161	Curved on Side	1 x 2 Teeth	5 ½ in 140 mm



Hoehn Scalp Hemostatic Forceps

CODE	DESCRIPTION	LENGTH
30-1115	Curved on Side, Serrated	5 ¾ in 137 mm



Raimondi Scalp Forceps

Infant

CODE	DESCRIPTION	TEETH	LENGTH
30-1360	Curved on Side	1 x 2	5 in 127 mm



Forceps (Spoon)

Spoon Forceps

Bayonet

CODE	TIP WIDTH	LENGTH
80-2060	2 mm	4.0 in 100 mm
80-2063	2 mm	4.0 in 100 mm
80-2061	4 mm	4.0 in 100 mm
80-2064	4 mm	4.0 in 100 mm
80-2062	6 mm	4.0 in 100 mm
80-2065	6 mm	4.0 in 100 mm

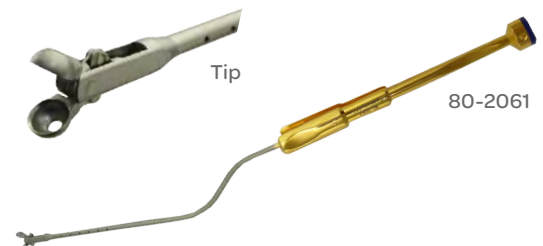

Yasargil Spoon Forceps

CODE	TIP WIDTH	LENGTH
58-4751	5.0 mm	9 ½ in 421 mm

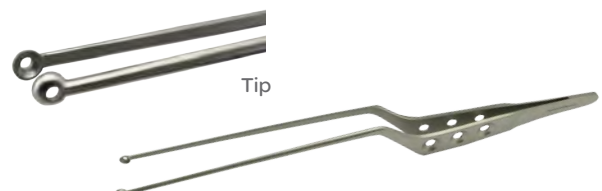

Forceps (Tendon)

Carroll Tendon-Pulling Forceps

CODE	SHAFT LENGTH	LENGTH
30-2540	5 in 127 mm	7½ in 191 mm



Forceps (Tissue)

Brain Tissue Forceps

CODE	TEETH	TIP WIDTH	LENGTH
30-1172	1x2 Teeth	1.0 mm	7 in 178 mm



Cushing Tissue Forceps

Dissecting End, 1 x 2 Teeth

CODE	DESCRIPTION	TIP WIDTH	LENGTH
30-1143	Gutsch Handle	1.3 mm	7 in 178 mm
30-1142	Gutsch Handle	1.7 mm	7 in 178 mm
30-1140	Serrated Handle	1.5 mm	7 in 178 mm
30-1145	Serrated Handle, With Gerald -Type Tips	1.6 mm	7¾ in 197 mm



D'Errico Bayonet Tissue Forceps

CODE	DESCRIPTION	TIP WIDTH	LENGTH
30-1201	1x2 Teeth	2.4 mm	8¾ in 222 mm



Forceps (Tissue)

Ferris-Smith Tissue Forceps

CODE	DESCRIPTION	TIP WIDTH	LENGTH
30-1132	2 x 3 Teeth	3.9 mm	6 ³ / ₄ in 171 mm



General Surgery Tissue Forceps

CODE	DESCRIPTION	LENGTH
67-7583	3.0 mm	8 in 203 mm

Gerald Tissue Forceps

CODE	DESCRIPTION	TIP WIDTH	LENGTH
30-1210	Straight, 1 x 2 Teeth	1.3 mm	7 in 178 mm
30-1213	Bayonet Shape, 1 x 2 Teeth, Working Distance: 3 ¹ / ₂ in (89 mm)	1.3 mm	7 ¹ / ₂ in 191 mm
32-3531	Fine Tungsten Carbide Inserts	1 mm	7 in 178 mm
32-3532	Fine Tungsten Carbide Inserts	1 mm	10 in 254 mm

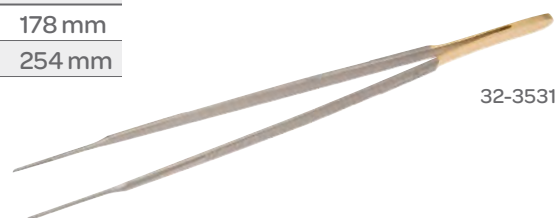

Hoer Tissue Forceps

Bayonet Shape, 1 x 2 Teeth, Gutsch Handle

CODE	WORKING DISTANCE	TIP WIDTH	LENGTH
30-1166	3 in 76 mm	2.1 mm	7 ³ / ₄ in 197 mm

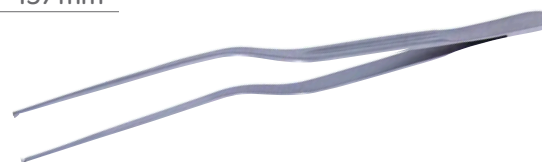

Forceps (Tissue)

Semkin Tissue Forceps

CODE	TIP WIDTH	LENGTH
30-1170	1.3 mm	5 in 127 mm



Forceps (Transsphenoidal)

Hardy™ Dressing Forceps

Bayonet

CODE	WORKING DISTANCE	TIP WIDTH	LENGTH
30-1205	4½ in 114 mm	1.0 mm	8¼ in 210 mm



Forceps (Tumor)

Rhoton® Tumor Forceps

Bayonet, Titanium, Serrated, Ring Tip

CODE	WORKING DISTANCE	TIP WIDTH	LENGTH
80-1736	3½ in 89 mm	4.0 mm	8½ in 216 mm
80-1748	3½ in 89 mm	4.0 mm	9½ in 241 mm



Yasargil Bayonet Tumor Grasping Forceps

CODE	CUP SIZE	LENGTH
58-4656	3.0 mm, with Teeth	8¾ in 222 mm
58-4645	3.0 mm Cup	8¾ in 222 mm
58-4652	3.0 mm, Flat Serrated	8¾ in 222 mm
58-4654	5.0 mm, Flat Serrated	8¾ in 222 mm

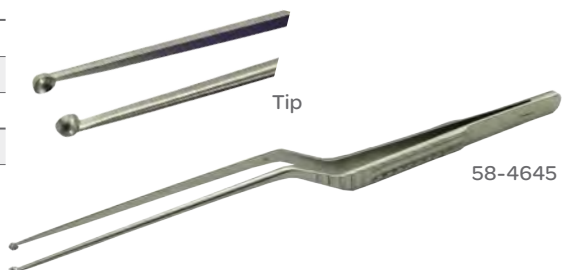

Forceps

Tying Forceps

Titanium

CODE	DESCRIPTION	TIP WIDTH	LENGTH
80-6630	Straight	0.7 mm	6 in 152 mm



Utility Forceps

Titanium

CODE	DESCRIPTION	TIP WIDTH	LENGTH
80-6631	Straight	0.3 mm	6 in 152 mm



Penfield Watchmaker Forceps

CODE	DESCRIPTION	TIP WIDTH	LENGTH
30-1194	Forceps	0.9 mm	7 in 178 mm



Clip Applying Forcep

Straight, Standard

CODE	DESCRIPTION	LENGTH
58-5048	Bayonet, Mini	8 in 200 mm



Forceps

Bayonet

CODE	DESCRIPTION	TIP WIDTH	LENGTH
80-2068	Curved	0.75 mm	3 $\frac{9}{10}$ in 100 mm
80-2066	Smooth	0.5 mm	3 $\frac{9}{10}$ in 100 mm

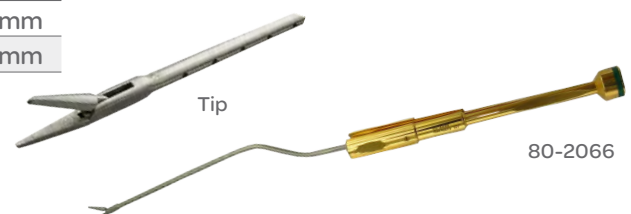

Forceps

Jewelers Forceps

CODE	DESCRIPTION	LENGTH
30-6712	#3	4 ³ / ₄ in 121 mm
30-6713	#3C	4 ⁵ / ₁₆ in 110 mm
30-6714	#4	4 ¹ / ₄ in 108 mm
30-6715	#5	4 ⁵ / ₁₆ in 110 mm



Malis® Forceps

Bayonet, Titanium

CODE	DESCRIPTION	BLUNT TIP	WORKING DISTANCE	LENGTH
80-1506	90° Curved Down	0.75 mm	3 ³ / ₄ in 95 mm	8 ¹ / ₂ in 216 mm
80-1504	90° Curved Up	0.75 mm	3 ³ / ₄ in 95 mm	8 ¹ / ₂ in 216 mm



Malis® Forceps

Straight, Titanium

CODE	DESCRIPTION	TIP WIDTH	LENGTH
80-1500	Blunt	0.75 mm	6 in 152 mm
80-1501	Fine	0.5 mm	6 in 152 mm
80-1508	Extra Fine Tip	0.25 mm	6 in 152 mm



Malis® Forceps

Bayonet, Titanium, Straight

CODE	DESCRIPTION	TIP WIDTH	WORKING DISTANCE	LENGTH
80-1502	Blunt Tip	0.75 mm	3 ³ / ₄ in 95 mm	8 ³ / ₄ in 222 mm
80-1503	Fine Tip	0.5 mm	3 ³ / ₄ in 95 mm	8 ³ / ₄ in 222 mm
80-1509	Extra-Fine Tip	0.25 mm	3 ³ / ₄ in 95 mm	8 ³ / ₄ in 222 mm



Forceps

Malis® Forceps

Bayonet, Titanium, Fine Tip

CODE	DESCRIPTION	TIP WIDTH	WORKING DISTANCE	LENGTH
80-1507	Angled Down	0.5 mm	3¾ in 95 mm	8½ in 216 mm
80-1505	Angled Up	0.5 mm	3¾ in 95 mm	8½ in 216 mm



80-1505

Rhoton® Forceps

Titanium

CODE	DESCRIPTION	TIP WIDTH	LENGTH
80-1700	Straight, Extra-Fine	0.3 mm	7 in 178 mm
80-1701	Straight, Fine	0.7 mm	7 in 178 mm
80-1702	Bayonet, Fine	0.5 mm	8½ in 216 mm
80-1703	Bayonet, Regular	1.0 mm	8½ in 216 mm



80-1702

Hooks (Ball)

Murphy Ball Hook

CODE	DESCRIPTION	LENGTH
57-3800	Ball Hook	9 in 229 mm



Tip

Hooks (Cervical Nerve)

Cervical Micro Nerve Hook

CODE	SIZE	HANDLE WIDTH	WORKING DISTANCE	LENGTH
46-2646	Micro	0.6 in 15 mm	4.1 in 104 mm	9½ in 241 mm
46-2647	Ultra Micro	0.6 in 15 mm	4.1 in 104 mm	9½ in 241 mm



46-2646

Hooks (Dissecting)

Adson Dissecting Hook

Rough-End Handle

CODE	DESCRIPTION	TIP DIAMETER	HOOK DEPTH		LENGTH	
38-1060	Sharp	0.9 mm	$\frac{3}{16}$ in	5.0 mm	$7\frac{3}{4}$ in	197 mm
38-1061	Blunt	0.9 mm	$\frac{3}{16}$ in	5.0 mm	$7\frac{3}{4}$ in	197 mm
67-7429	Blunt	0.9 mm	$\frac{3}{16}$ in	5.0 mm	$7\frac{3}{4}$ in	197 mm



38-1060

Hooks (Dural)

Adson Dural Hook

CODE	DESCRIPTION	LENGTH	
20-2722	Sharp	8 in	203 mm
20-2723	Blunt	8 in	203 mm

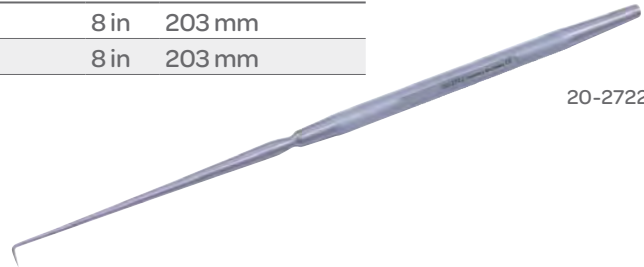

20-2722

Corkscrew Dural Hook

Reversible Handle

CODE	TIP DIAMETER	LENGTH	
38-1045	4.0 mm	$6\frac{1}{2}$ in	165 mm

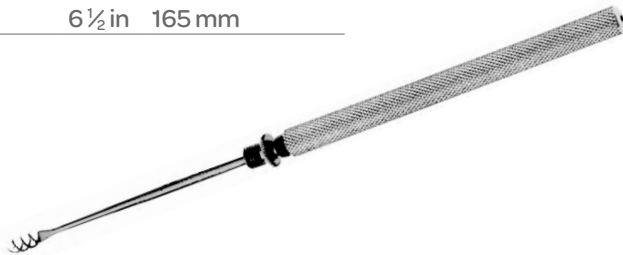

Hooks (Dural)

Cushing Dural Hook

CODE	DESCRIPTION	TIP DIAMETER	LENGTH
38-1028	Dural Hook	2.0 mm	5½ in 140 mm



Dural Hook

CODE	DESCRIPTION	TIP DIAMETER	LENGTH
38-1038	Dural Hook	2.0 mm	6½ in 165 mm



Frazier Dural Hook

CODE	DESCRIPTION	TIP DIAMETER	LENGTH
38-1040	Dural Hook	0.4 mm	5 in 127 mm



Lahey Clinic Dural Hook

CODE	DESCRIPTION	LENGTH
38-1042	Sharp, Depth 2.8 mm	5¼ in 133 mm



Hooks (Exploration & Coagulation)

Caspar Exploration & Coagulation Hook

Insulated Shaft, Ball Probe Tip

CODE	DESCRIPTION	LENGTH
57-5008	#1, 90° Angle, Small	9 ³ / ₄ in 248 mm
57-5009	#2, 90° Angle, Medium	9 ³ / ₄ in 248 mm
57-5010	#3, 90° Angle, Large	9 ³ / ₄ in 248 mm
57-5011	#4, 90° Angle, Extra-Large	9 ³ / ₄ in 248 mm

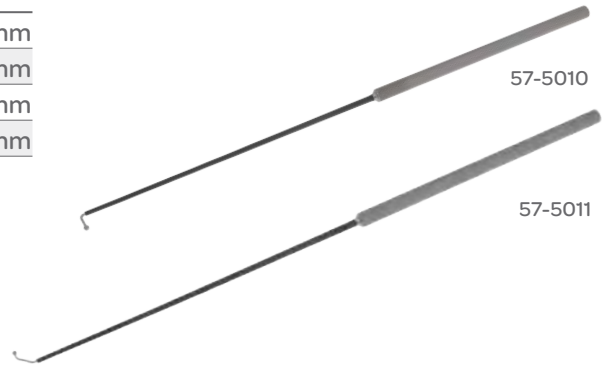

Hooks (Nerve)

Cushing Gasserian Ganglion Hook

CODE	DESCRIPTION	HOOK DEPTH	LENGTH
38-1030	Blunt	³ / ₁₆ in 5.0 mm	9 in 229 mm
67-7430	Hook	³ / ₁₆ in 5.0 mm	11 in 279 mm



Cushing Nerve Hook

CODE	BALL TIP	LENGTH
20-2231	4.0 mm	7 ¹ / ₂ in 191 mm
20-2232	6.0 mm	7 ¹ / ₂ in 191 mm

Hooks (Nerve)

Dandy Nerve Hook

Blunt

CODE	DESCRIPTION	LENGTH	
38-1080	Straight	8 ⁵ / ₈ in	219 mm
57-5001	Straight	9 in	229 mm
67-7431	Straight	10 in	254 mm
57-5002	Left	9 in	229 mm
57-5003	Right	9 in	229 mm



38-1080

Hoer Nerve Hook

Solid Triangular Handle, Blunt

CODE	DESCRIPTION	TIP DIAMETER	HOOK DEPTH		LENGTH	
38-1085	Straight	1.0 mm	¼ in	7.0 mm	8 ³ / ₄ in	222 mm
57-5000	Straight	1.0 mm	¼ in		9 in	230 mm
67-7432	Straight		¼ in	7.0 mm	10 in	254 mm
57-4999	Angled	1.0 mm	¼ in		9 in	230 mm



38-1085

Karlin™ Micro Nerve Hook

CODE	DESCRIPTION	LENGTH	
46-3171	Nerve Hook	8 ¹ / ₂ in	216 mm



Hooks (Nerve)

Lucae Nerve Hook

Probe Tip

CODE	DESCRIPTION	LENGTH
20-2201	Small	5½ in 140 mm
20-2202	Medium	5½ in 140 mm

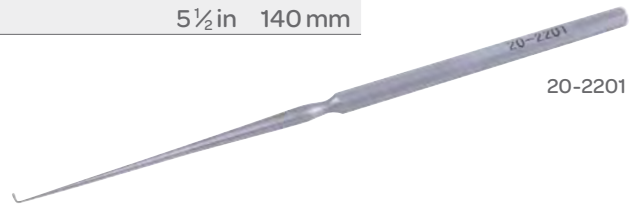

20-2201

Malis® Nerve Hook

CODE	DESCRIPTION
57-5771	2.0 mm

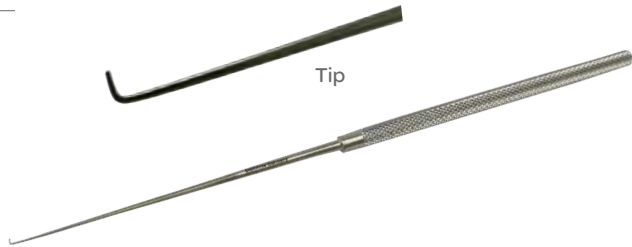

Malis® Nerve Hook

Titanium Handle

CODE	DESCRIPTION	LENGTH
58-6063T	Ball Tip 3 mm	7¼ in 184 mm
58-6065T	Ball Tip 3 mm	7¼ in 184 mm

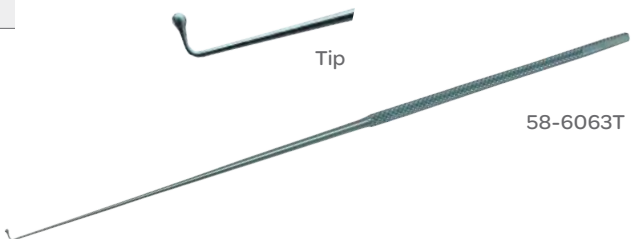

58-6063T

Hooks (Nerve)

Malis® Nerve Hook

Stainless Steel Shaft, Titanium Handle

CODE	DESCRIPTION	TIP WIDTH	LENGTH
80-1531	Ball	3 mm	7¼ in 184 mm
80-1532	Blunt	2 mm	7¼ in 184 mm
80-1533	Blunt	3 mm	7¼ in 184 mm
67-7433	Ball	3 mm	10 in 254 mm
67-7434	Blunt	2 mm	10 in 254 mm
67-7435	Blunt	3 mm	10 in 254 mm



Nerve Hook

CODE	DESCRIPTION	LENGTH
20-2057	7 mm Wide, Blunt	6¼ in 159 mm



Rhoton® Nerve Hook

Titanium

CODE	DESCRIPTION	TIP WIDTH	LENGTH
80-1688	90°, Semi-Sharp	0.5 mm	7½ in 191 mm
80-1689	90°, Blunt	0.8 mm	7½ in 191 mm
80-1690	40°, Semi-Sharp	0.7 mm	7½ in 191 mm
67-7436	90°, Semi-Sharp	0.5 mm	10 in 254 mm
67-7437	90°, Blunt	0.8 mm	10 in 254 mm
67-7438	40°, Semi-Sharp	0.7 mm	10 in 254 mm



Hooks (Nerve)

Scoville Hook

CODE	LENGTH
13-1004C	2 in 51 mm



Scoville Nerve Hook

CODE	DESCRIPTION	LENGTH
57-5045	Double-Ended	11 3/4 in 300 mm



Sisson Nerve Hook

CODE	DESCRIPTION
57-5005	Nerve Hook

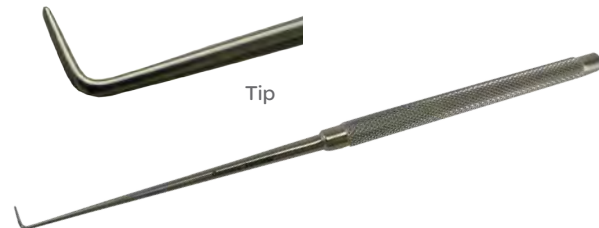

Ultra™ Micro Nerve Hook

CODE	DESCRIPTION	LENGTH
46-3172	Nerve Hook	8 1/2 in 216 mm

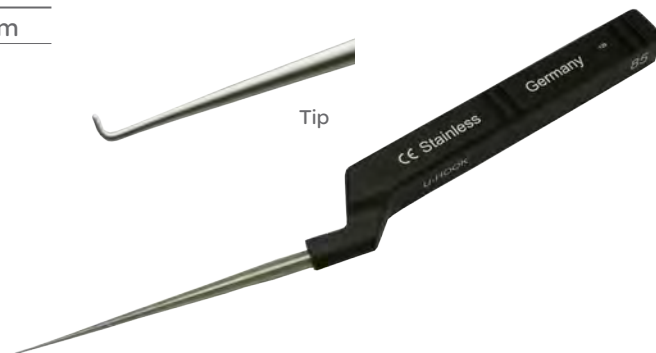

Hooks (Nerve)

Weary Nerve Hook

Black Finish, Fine, Blunt

CODE	TIP DIAMETER	HOOK DEPTH	LENGTH
38-1020	0.9 mm	$\frac{1}{8}$ in 3 mm	$7\frac{3}{4}$ in 197 mm



Hooks (Skin)

Carroll Skin Hook

CODE	DESCRIPTION	HOOK SIZE	LENGTH
38-2515	Sharp	$\frac{1}{8}$ in 3 mm	6 in 152 mm



Converse Skin Hook

CODE	DESCRIPTION	LENGTH
38-6638	Small, 3 mm, Sharp	$7\frac{1}{4}$ in 184 mm
38-6640	Large, 5 mm, Sharp	$7\frac{1}{4}$ in 184 mm



38-6638

Hooks (Skin)

Gilles Skin Hook

CODE	DESCRIPTION	LENGTH
38-2520	3 mm, Sharp	7 $\frac{1}{8}$ in 181 mm



Hooks (Spring)

Yasargil Spring Hook

CODE	LENGTH
57-6405	12 $\frac{1}{4}$ in 311 mm
57-6408	16 in 406 mm

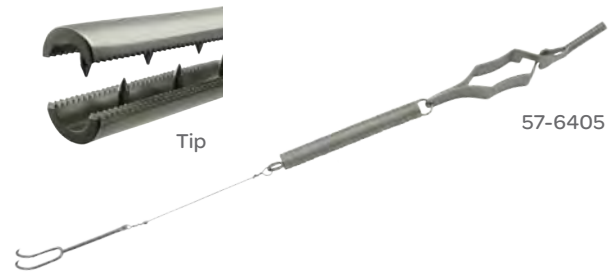

Hooks

Graham Hook

CODE	DESCRIPTION	LENGTH
57-0070	Blunt	6 $\frac{1}{2}$ in 165 mm

Jannetta Hook

CODE	DESCRIPTION	LENGTH
58-6209A	45° Angle, Medium	7 $\frac{1}{2}$ in 191 mm



Hooks

Rhoton® Hook

Titanium

CODE	DESCRIPTION	LENGTH
58-6032T	45° Angle, Semi-Sharp	7½ in 191 mm
58-6030T	90° Angle, Semi-Sharp	7½ in 191 mm
58-6031	90° Angle, Dull	7½ in 191 mm



Scoville Hook

CODE	DESCRIPTION	LENGTH
13-1005C	Hook	3 in 76 mm
57-5821	Hook	2 in 51 mm



Knife Handles (Micro)

Micro Knife Handle

CODE	DESCRIPTION	LENGTH
58-7576	Vertical	8 in 203 mm

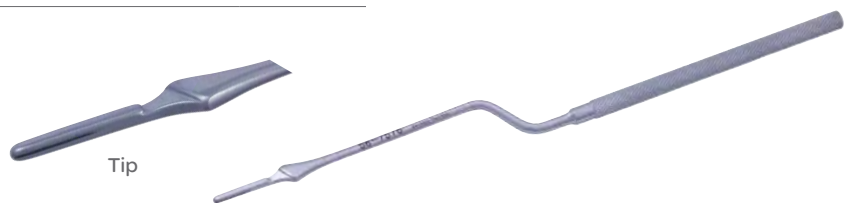

Knife Handles (Transsphenoidal)

Hardy™ Knife Handle

Bayonet

CODE	DESCRIPTION	WORKING DISTANCE	LENGTH
80-1314	Lateral	3½ in 90 mm	8⅞ in 205 mm
80-1313	Vertical	3½ in 90 mm	8⅞ in 205 mm



Knives (Angled)

Jannetta Angled Knife

CODE	DESCRIPTION	LENGTH
58-6201	Small	7½ in 191 mm
58-6202	Large	7½ in 191 mm

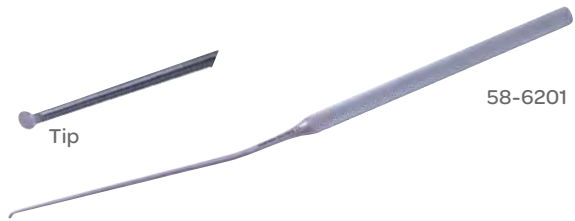

Knives (Arachnoid)

Stecher Arachnoid Knife

CODE	DESCRIPTION	TIP WIDTH	LENGTH
40-1020	Straight	1.5 mm	8 in 203 mm
40-1021	Angled Left	1.5 mm	8 in 203 mm
40-1022	Angled Right	1.5 mm	8 in 203 mm



Knives (Cordotomy)

Bucy Cordotomy Knife

CODE	BLADE	LENGTH
57-3851	6 mm, Forward Cutting	6½ in 165 mm

Knives (Ganglion)

Crile Gasserian Ganglion Knife

Double-Ended

CODE	TIP SIZES	LENGTH
40-1002	6 mm, 16 mm	8½ in 216 mm



Knives (Microvascular Arachnoid)

Yasargil Microvascular Knife

Arachnoid

CODE	DESCRIPTION	LENGTH
58-3305	Curved Up	7¼ in 184 mm

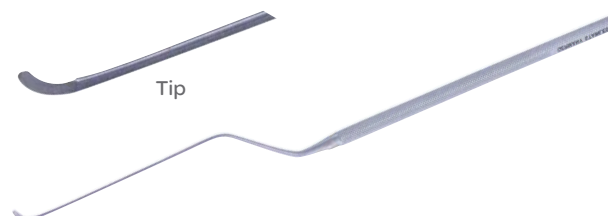

Knives (Tumor)

Tumor Knife

CODE	DESCRIPTION	LENGTH
80-2075	1 mm, Round	7⅞ in 200 mm
80-2076	3 mm, Round	7⅞ in 200 mm
80-2077	5 mm, Round	7⅞ in 200 mm

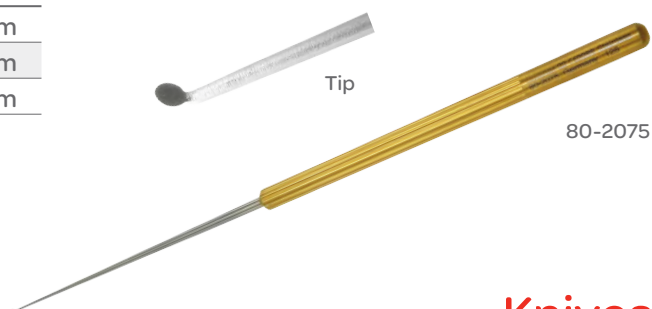

Knives

Knife

CODE	DESCRIPTION	LENGTH
57-3845	Hollow Handle, Sharp	8 in 203 mm

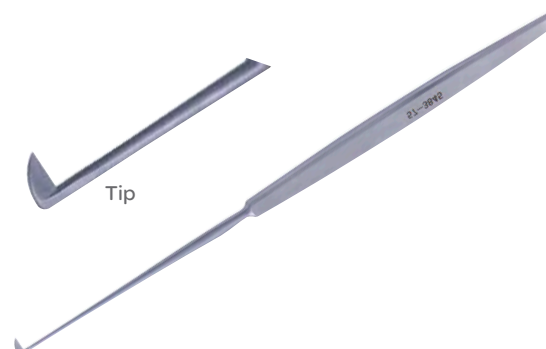

Ligature Instruments (Carrier)

Yasargil Ligature Carrier

Ball Probe Tip

CODE	DESCRIPTION	LENGTH	
58-3062	Long Curve	7¼ in	184 mm
58-3063	Full Curve	7¼ in	184 mm
58-3065	90° Angle	7¼ in	184 mm

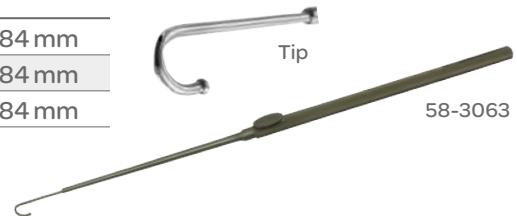

Ligature Instruments (Passer)

Malis® Ligature Passer

Stainless Steel Shaft, Titanium Handles

CODE	HOOK SIZE	LENGTH	
80-1530	3 mm	7⅜ in	187 mm



Mallets

Heath Mallet

CODE	DESCRIPTION	HEAD DIMENSIONS		LENGTH	
32-3330	2 lbs 908 g	2½ x 1½ in	64 x 38 mm	7¼ in	184 mm

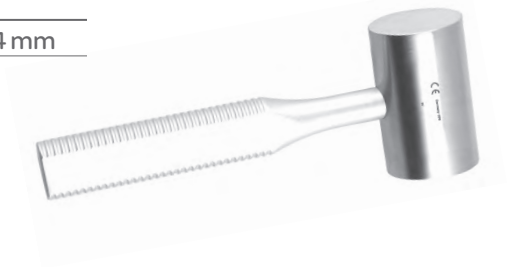

Mallets (Percussion)

Taylor Percussion Hammer

CODE	DESCRIPTION	LENGTH	
88-4000	Percussion Hammer	8 in	203 mm



Markers

Surgical Marker

Gentian Violet Dye, Sterile, Disposable, Packed with 6 in (152 mm) Ruler

CODE	DESCRIPTION	QTY
43-1030	Regular Tip	36/Box
43-1032	Micro Tip	36/Box



Mirrors (Transsphenoidal)

Hardy™ Transsphenoidal Mirror

Bayonet Shape, Tip Width 5.0 mm

CODE	WORKING DISTANCE	LENGTH
80-1366	4½ in 114 mm	9 in 229 mm



Needle Holders (Bayonet)

Malis® Bayonet Needle Holder

Titanium, With Lock

CODE	DESCRIPTION	LENGTH
58-5938T	Straight, Round Handle	8¾ in 222 mm



Needle Holders (Bayonet)

Rhoton® Needle Holder

Titanium, Bayonet

CODE	DESCRIPTION	LENGTH
80-1746	Straight	9½ in 241 mm
80-1747	Curved	9½ in 241 mm

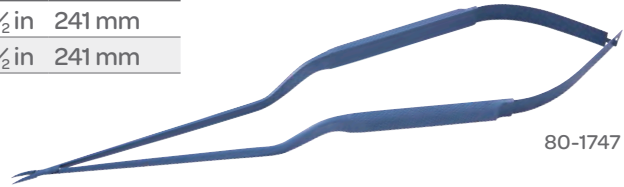

80-1747

Rhoton® Needle Holder

Titanium

CODE	DESCRIPTION	TIP WIDTH	LENGTH
80-1726	Straight	0.9 mm	7 in 178 mm
80-1728	Straight, Bayonet	0.9 mm	8½ in 216 mm
80-1725	Curved, Fine Tip	0.5 mm	7 in 178 mm
80-1727	Curved	0.9 mm	7 in 178 mm
80-1729	Curved, Bayonet	0.9 mm	8½ in 216 mm

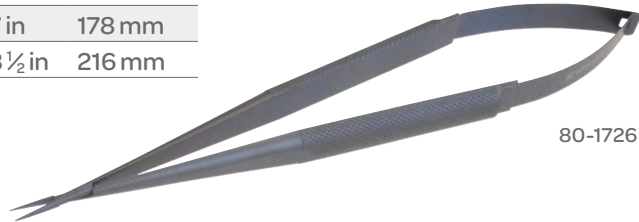

80-1726

Titanium Malis® Bayonet Needle Holder

CODE	DESCRIPTION	TIP	LENGTH
59-5912	Straight	6 mm	7 in 178 mm



Yasargil Bayonet Needle Holder

CODE	DESCRIPTION	LENGTH
59-2342	Straight	9 in 229 mm
59-2349	Straight	9 in 229 mm
59-2345	Curved	8¾ in 222 mm



59-2342

Needle Holders (Bayonet)

Spetzler Neurovascular Needle Holder

Titanium, Bayonet with Lock

CODE	TIP	WORKING DISTANCE	LENGTH
80-1909	30° Tip, Curved	4 in 102 mm	9½ in 241 mm



Needle Holders (Dural)

Adson Dural Needle Holder

CODE	DESCRIPTION	LENGTH
64-1000	Fenestrated Jaws	7¼ in 184 mm



Needle Holders (Micro)

Needle Holder

Curved, Titanium

CODE	DESCRIPTION	TIP WIDTH	LENGTH
80-6621	Extra Fine	0.5 mm	6 in 152 mm
80-6006	Fine Tip	0.7 mm	6 in 152 mm
80-6007	Standard Tip	1 mm	6 in 152 mm



80-6621

Needle Holders (Micro)

Micro Needle Holder

Stainless Steel

CODE	DESCRIPTION	TIP WIDTH	LENGTH
80-2002	Straight Tip	0.5 mm	5½ in 140 mm
80-2003	Curved Tip	0.5 mm	5½ in 140 mm



Needle Holders

Malis® Needle Holder

Titanium

CODE	HANDLE DESCRIPTION	TIP DESCRIPTION	TIP WIDTH	LENGTH
80-1510	Straight		0.5 mm	6¾ in 171 mm
80-1511	Straight		0.5 mm	6¾ in 171 mm
80-1514	Straight	Fine	0.5 mm	6¾ in 171 mm
80-1515	Bayonet	Straight, Extra Fine	0.4 mm	8¾ in 222 mm
80-1512	Bayonet	Fine	0.6 mm	8¾ in 222 mm



Needle Holder

CODE	DESCRIPTION	LENGTH
80-2069	Bayonet 2 mm x 6 mm	4 in 100 mm
80-2070	Bayonet 1 mm x 6 mm	4 in 100 mm

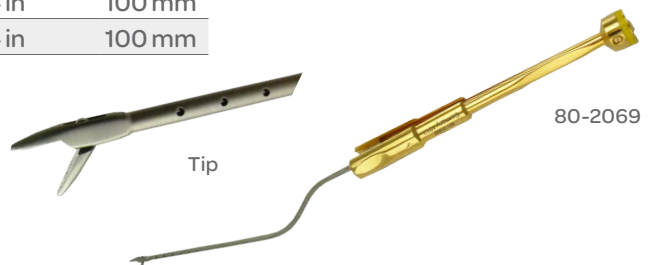

Needles

Rhoton® #12 Straight Point Needle

Titanium

CODE	DESCRIPTION	TIP WIDTH	LENGTH
80-1691	Semi-Sharp, Titanium	0.8 mm	7½ in 191 mm

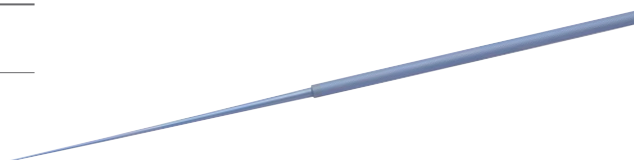

Needles (Ventricular)

Cone Ventricular Needle

With Two Holes, Luer Lock Hub

CODE	DESCRIPTION	LENGTH
57-7736	12 Gauge	3½ in 89 mm
57-7735	13 Gauge	3½ in 89 mm
57-7734	14 Gauge	3½ in 89 mm
57-7733	15 Gauge	3½ in 89 mm
57-7732	16 Gauge	3½ in 89 mm
57-7731	17 Gauge	3½ in 89 mm
57-7730	18 Gauge	3½ in 89 mm
57-7729	19 Gauge	3½ in 89 mm



57-7736

Osteotomes (Spine)

Hoke Osteotome

CODE	DESCRIPTION	BLADE WIDTH	LENGTH
32-3439	Straight	3 mm	6 in 152 mm
32-3435	Straight	6 mm	6 in 152 mm
32-3436	Straight	10 mm	6 in 152 mm
32-3437	Straight	13 mm	6 in 152 mm
32-3438	Straight	16 mm	6 in 152 mm
32-3430	Curved	3 mm	6 in 152 mm
32-3431	Curved	6 mm	6 in 152 mm
32-3432	Curved	13 mm	6 in 152 mm
32-3434	Curved	16 mm	6 in 152 mm



32-3438

Probes (Ball)

Ball Probe

CODE	DESCRIPTION	LENGTH
57-3801	60° Angle, 2 mm	14 in 356 mm



Probes (Double Forked)

Jannetta Double Forked Probe

CODE	DESCRIPTION	LENGTH
58-6212	Small, 30° Angle	7 ½ in 191 mm

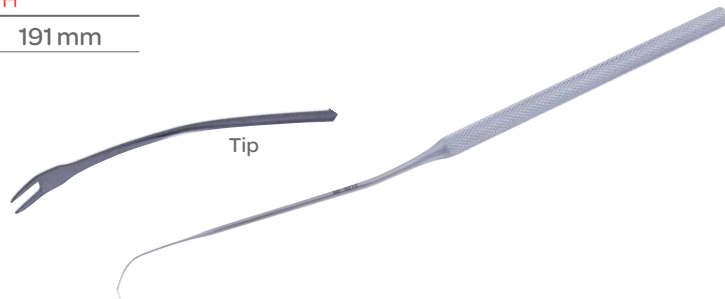

Probes (Micro)

Jacobson Micro Probe

CODE	DESCRIPTION	LENGTH
58-3020	Angled, Ball Tip	7 ¼ in 184 mm
58-3022	Straight, Double Ball Tip	7 ¼ in 184 mm

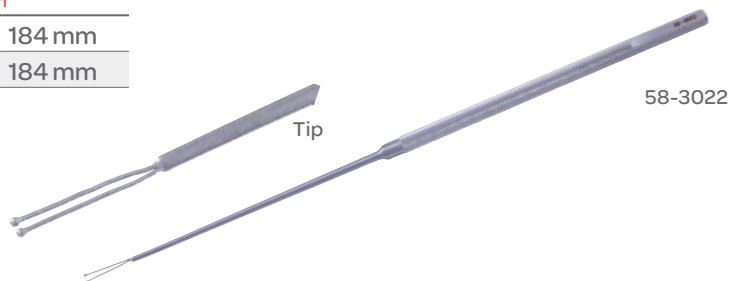

Probes

Jannetta Probe

CODE	DESCRIPTION	LENGTH
58-6208	Small, 45° Angle	7½ in 191 mm

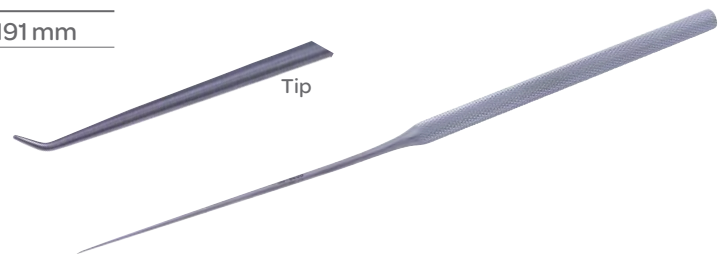

Punches (Skull)

Cone Skull Punch

CODE	DESCRIPTION	LENGTH
57-6111	Adult	9½ in 241 mm



Punches (Stella)

Hardy™ Stella Punch

CODE	DESCRIPTION	BITE	LENGTH
80-1344	40° Up	1 mm	7 in 178 mm
80-1340	40° Up	2 mm	7 in 178 mm
80-1341	90° Up	2 mm	7 in 178 mm
80-1343	40° Down	2 mm	7 in 178 mm
80-1342	90° Down	2 mm	7 in 178 mm

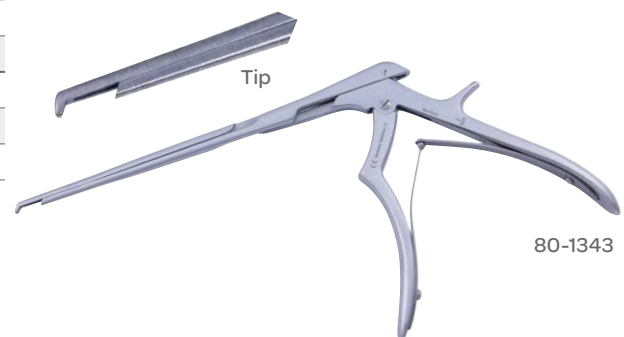

Pushers (Suture)

Jacobson Suture Pusher

CODE	DESCRIPTION	LENGTH
58-3055	Short Curve, Ball Probe Tip	7¼ in 184 mm

Rasps (Bone)

Miller Bone Rasp

CODE	DESCRIPTION	LENGTH
26-1012	Double-Ended, 5 mm and 7 mm	7¼ in 184 mm

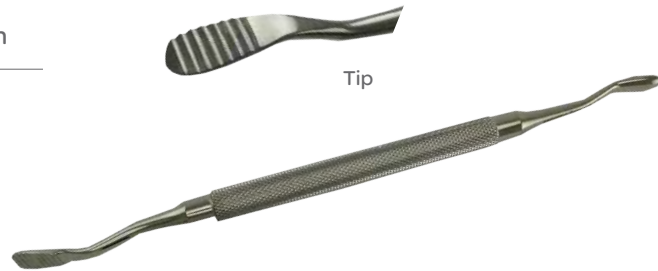

Retractors (Cerebellar)

Miskimon Cerebellar Retractor

CODE	DESCRIPTION	BLADE WIDTH	BLADE DEPTH	LENGTH
50-1363	7 x 7 Sharp Prongs	1¼ in 32 mm	1⅜ in 35 mm	7½ in 191 mm
24-2810	Angled			8¾ in 222 mm

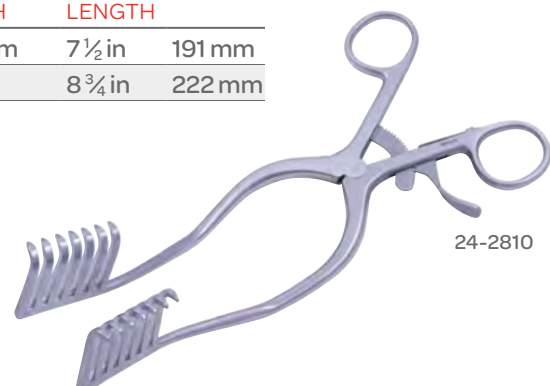

Retractors (Crockard™)



50-1670

Crockard™ Transoral Instrument Set

The Crockard™ Transoral Instrument Set is a coordinated set of instruments used to approach a large area of pathology from the sphenoid to the C3 vertebra via the transoral technique.

CODE	DESCRIPTION	QUANTITY
50-1670	Set Includes:	
50-1651	Crockard™ Transoral Retractor Body	1/Each
50-1652	Crockard™ Large Tongue Retractor Blade	1/Each
50-1653	Crockard™ Small Tongue Retractor Blade	1/Each
50-1654	Crockard™ 90° Retractor Blade	2/Each
50-1655	Crockard™ Curved Retractor Blade	2/Each
50-1656	Crockard™ Retractor Blade Connector	2/Each
50-1657	Crockard™ Suction Tube Holder, Short	1/Each
50-1658	Crockard™ Suction Tube Holder, Long	1/Each
50-1659	Crockard™ Hard Palate Retractor	1/Each
50-1660	Crockard™ Pharyngeal Retractor, Small	1/Each
50-1661	Crockard™ Pharyngeal Retractor, Large	1/Each
50-1662	Crockard™ Odontoid Peg Grasping Forceps	1/Each
50-1663	Crockard™ Ligament Grasping Forceps	1/Each
50-1664	Crockard™ Sterilizing/Storage Case	

Retractors (Crockard™)



Crockard™ Hard Palate Retractor

CODE	DESCRIPTION	LENGTH		WIDTH	
50-1659	Hard Palate Retractor	4 ¼ in	108 mm	1 in	25 mm



Crockard™ Mid-Facial Osteotomy Retractor Plate

Uniquely and exclusively fashioned to function with Crockard™ Transoral Instrument Set (50-1670), especially Tongue Retractor Blades (50-1692 and 15-1653) and Retractor Body (50-1651). For surgery of middle and upper clivus and transpalatal incisions. Retracts soft and hard palate from skull as tongue blade retracts hard palate downward.

CODE	HANDLE LENGTH		BLADE DEPTH		LENGTH	
50-1668	6 in	152 mm	3 in	76 mm	6 in	152 mm

Retractors (Crockard™)



50-1660

Crockard™ Pharyngeal Retractor

CODE	DESCRIPTION	LENGTH	
50-1660	Small	7 in	177 mm
50-1661	Large	7½ in	190 mm



50-1654

Crockard™ Retractor Blade

CODE	DESCRIPTION	BLADE LENGTH		BLADE WIDTH		OVERALL LENGTH	
50-1654	90° Retractor Blade	1½ in	38 mm	0.8 in	20 mm	5 in	127 mm
50-1655	Curved 180°	1½ in	38 mm	0.5 in	12 mm	5 in	127 mm



Crockard™ Retractor Blade Connector

CODE	DESCRIPTION	DIMENSIONS	
50-1656	Retractor Blade Connector	1½ x 3⅜ in	38 x 81 mm

Retractors (Crockard™)



Crockard™ Sterilizing & Storage Case

Custom Designed for the Crockard™ Transoral Instrument Set 50-1670

CODE	LENGTH	DIMENSIONS
50-1664	18 in 457 mm	10½ x 7¼ in 266 x 184 mm



Crockard™ Suction Tube Holder

CODE	DESCRIPTION	LENGTH
50-1657	Short	1½ in 38 mm
50-1658	Long	2 in 51 mm



Crockard™ Tongue Retractor Blade

CODE	DESCRIPTION	BLADE LENGTH	OVERALL LENGTH
50-1653	Small	3 in 76 mm	6 in 152 mm
50-1652	Large	3½ in 91 mm	6 in 152 mm

Retractors (Crockard™)



Crockard™ Transoral Retractor Body

CODE	LENGTH	WIDTH
50-1651	6 in 152 mm	2¾ in 70 mm

Retractors (Decompression)



Decompression Retractor

CODE	DESCRIPTION	BLADE WIDTH	BLADE DEPTH	LENGTH
50-1060	Fenestrated Blade	½ in 13 mm	⅞ in 22 mm	8⅜ in 213 mm

Retractors (Greenberg®)

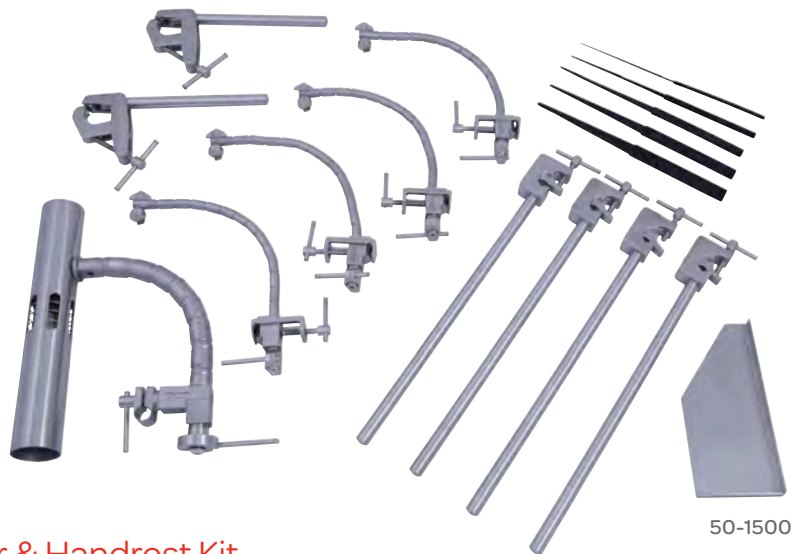

50-1500

Greenberg® Universal Retractor & Handrest Kit

The Greenberg® Retractor is a modular, self-retaining neurosurgical/microsurgical retractor system. The Greenberg® system provides the surgeon increased control and support in dissection as well as reliable exposure in multiple planes of retraction. A variety of configurations are possible with a combination of component parts. Speak to your Symmetry Sales Representative for a more complete description of the possible retraction levels.

	CODE	DESCRIPTION	LENGTH		TAPERED BLADE WIDTH		QTY
	50-1500	Includes the Following:					
BARS	50-1507	Greenberg® Primary Bar, Attaches to Skull Clamp	6 in	152 mm			2
	50-1508	Greenberg® Secondary Bar, Attaches to Primary Bar	12 in	305 mm			4
ARM	50-1509	Greenberg® Long Retractor Arm Attaches to primary or secondary bar	9½ in	241 mm			4
		Blades Mount onto Long Arm (50-1509) or Short Arm (50-1511)					
BLADES	50-1534	Greenberg® Tapered Retractor Blade	¼ x ¼ in	1.6 x 19 mm	9 in	229 mm	1
	50-1533	Greenberg® Tapered Retractor Blade	⅜ x ⅜ in	2 x 10 mm	9 in	229 mm	1
	50-1532	Greenberg® Tapered Retractor Blade	⅛ x ½ in	3 x 13 mm	9 in	229 mm	1
	50-1531	Greenberg® Tapered Retractor Blade	⅝ x ⅝ in	4 x 16 mm	9 in	229 mm	1
	50-1530	Greenberg® Tapered Retractor Blade	¼ x ¾ in	6 x 19 mm	9 in	229 mm	1
HANDREST	50-1512	Greenberg® Handrest Attaches to short coupler (50-1522) or a secondary bar (50-1508 or 50-1516)	10 in	254 mm			
PATTIE TRAY	50-1513	Greenberg® Pattie Tray Attaches to Long or Short Arm (50-1509 or 50-1511)	3 in	76 mm	6¼ in	171 mm	1

Retractors (Greenberg®)

Greenberg® Universal Retractor & Handrest Kit (continued)

CODE	DESCRIPTION	WIDTH	DEPTH	LENGTH	QTY
50-1514	Greenberg® Retractor Case - Includes Four Compartments for Various Components	10 in (254 mm)	2 1/8 in (60 mm)	17 in (432 mm)	1
Compartment Sizes:					
	Compartment # 1	7 3/4 in (197 mm)	10 3/4 in (264 mm)		
	Compartment # 2	2 1/8 in (54 mm)	17 in (432 mm)		
	Compartment # 3	4 5/8 in (117 mm)	6 3/4 in (171 mm)		
	Compartment # 4	3 1/8 in (79 mm)	6 3/4 in (171 mm)		



50-1514

Greenberg® Floating Secondary Bar

CODE	DESCRIPTION	LENGTH
50-1516	Attaches to Primary or Secondary Bar	12 in 304 mm



Greenberg® Hand Rest

CODE	DESCRIPTION	LENGTH
50-1512	Attaches to Short Coupler (50-1509) or Secondary Bar (50-1508 or 50-1516)	10 in 254 mm



Retractors (Greenberg®)

Greenberg® Instrument Holder

Superior Retractor

CODE	DESCRIPTION
50-1523	Small, Holds Shafts Up to $\frac{5}{16}$ in (8.0 mm) Diameter and Flat Instruments



Greenberg® Instrument Holder

Condylar Retractor

CODE	DESCRIPTION
50-1524	Large, Holds Shafts Up to 1 in (25 mm) Diameter

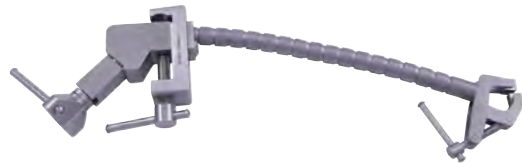

Greenberg® Instrument Holder

CODE	DESCRIPTION
50-1525	Extra-Large, Holds Shafts up to 2 in (51 mm) Diameter



Greenberg® Micro Instrument Holder Collateral Retractor

CODE	DESCRIPTION
50-1529	Flexbar Arm Used to Hold Microinstruments, Holds Up to $\frac{1}{8}$ in (3 mm) Diameter



Retractors (Greenberg®)

Greenberg® Long Arm

Patellar Retractor

CODE	DESCRIPTION
50-1509	Attaches to Primary or Secondary Bar

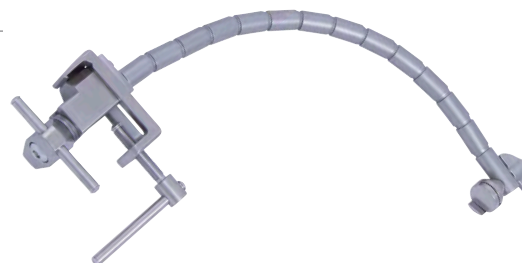

Greenberg® Maxi-Vise Adapter

Double the holding diameter of arms from 4 mm to 8 mm

Useful for holding suction devices and other various microsurgical instruments

CODE	DESCRIPTION
50-1515	Attaches to the Greenberg® Flexible Arms (50-1509 and 50-1511)



Greenberg® Pattie Tray

CODE	DESCRIPTION	LENGTH
50-1513	Attaches to Long or Short Arm (50-1509 or 50-1511)	6¼in 171 mm



Retractors (Greenberg®)

Greenberg® Style Ultra™ Cranial Pattie Tray

CODE	DESCRIPTION	LENGTH
59-7905	Titanium	6¼ in 171 mm

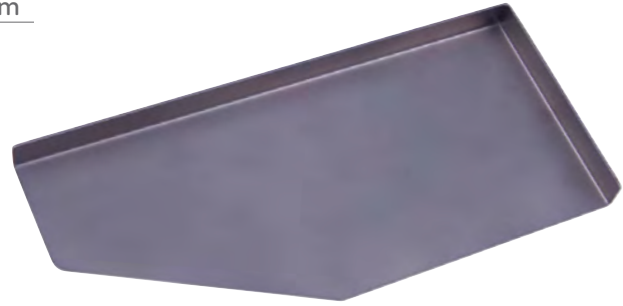

Greenberg® Primary Bar

CODE	DESCRIPTION	LENGTH
50-1507	Attaches to Skull Clamp	6 in 152 mm



Greenberg® Retractor Blade

Tapered

CODE	TAPERED BLADE WIDTH	BLADE LENGTH
50-1534	¼ x ¼ in	1.6 x 19 mm 9 in 229 mm
50-1533	⅜ x ⅜ in	2 x 10 mm 9 in 229 mm
50-1532	½ x ½ in	3 x 13 mm 9 in 229 mm
50-1531	⅝ x ⅝ in	4 x 16 mm 9 in 229 mm
50-1530	¾ x ¾ in	6 x 19 mm 9 in 229 mm



50-1530

Retractors (Greenberg®)

Greenberg® Secondary Bar

CODE	DESCRIPTION	LENGTH
50-1508	Attaches to Primary Bar	12 in 304 mm

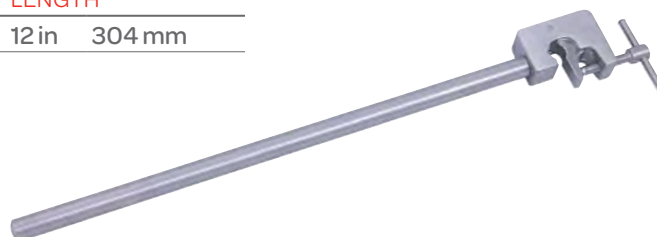

Greenberg® Short Coupler

CODE	DESCRIPTION	LENGTH
50-1522	Can Be Used as Mount for the Greenberg® Handrest	5½ in 140 mm



Greenberg® Short Retractor Arm

CODE	DESCRIPTION	LENGTH
50-1511	Attaches to Primary Bar or Secondary Bar	6½ in 165 mm



Retractors (Greenberg®)



Greenberg® Sterilizing Case

Includes Four Compartments for Various Components

CODE	DESCRIPTION	WIDTH	DEPTH	LENGTH	QTY
50-1514	Universal Retractor Case	10 in (254 mm)	2 1/8 in (60 mm)	17 in (432 mm)	1
Compartment Sizes:					
	Compartment # 1	7 3/4 in (197 mm)	10 3/4 in (264 mm)		
	Compartment # 2	2 1/8 in (54 mm)	17 in (432 mm)		
	Compartment # 3	4 5/8 in (117 mm)	6 3/4 in (171 mm)		
	Compartment # 4	3 1/8 in (79 mm)	6 3/4 in (171 mm)		

Cushing Retractor

CODE	DESCRIPTION	JAW LENGTH	LENGTH
32-3633		10 mm	11 in 279 mm
32-3634		11 mm	14 in 356 mm



32-3633

Retractors (Hand-Held)

Oldberg Retractor

CODE	DESCRIPTION	JAW LENGTH	LENGTH
57-5253	3 Prong, 13 mm	8 ¼ in	210 mm
57-5254	4 Prong, 15 mm	8 ¼ in	210 mm



57-5253

NEURO

Retractors (Jannetta)

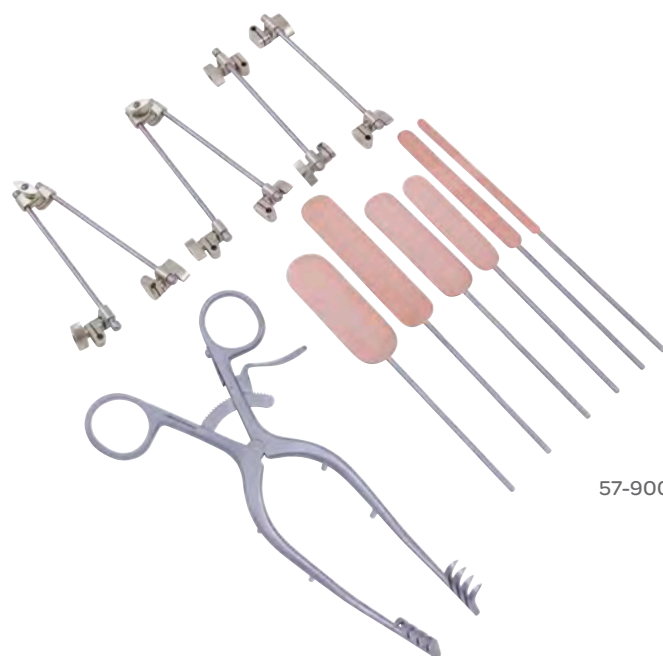

57-9000

Jannetta Posterior Fossa Retractor

CODE	DESCRIPTION	DETAIL	LENGTH
57-9000	Complete Set Includes:		
57-9024	Double Round Bar	3 Swivels	4 in 260 mm
57-9028	Malleable Retractor Blade	15 x 70 mm	6 ½ in 165 mm
57-9030	Malleable Retractor Blade	20 x 75 mm	6 ¾ in 171 mm
57-9032	Malleable Retractor Blade	25 x 75 mm	6 ¾ in 171 mm
57-9034	Malleable Retractor Blade	10 x 95 mm	7 ½ in 190 mm
57-9036	Malleable Retractor Blade	20 x 95 mm	7 ½ in 190 mm
57-9038	Malleable Retractor Blade	5 x 95 mm	7 ½ in 190 mm
57-9022	Retractor Body	With 4 Posts	
57-9026	Round Bar	With 2 Swivels	

Retractors (Leyla)

Leyla Brain Retractor

CODE	DESCRIPTION
57-5910	Flexible Tension Arm

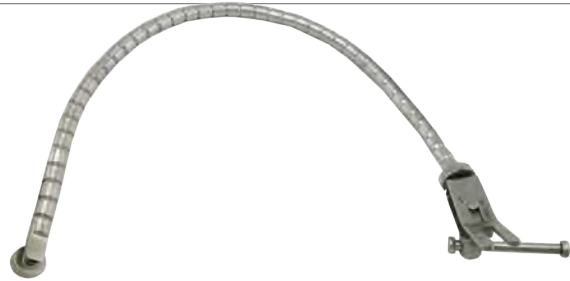

Leyla Brain Retractor

CODE	DESCRIPTION
57-5941	Rigid Holding Arm



Leyla Brain Retractor

CODE	DESCRIPTION
57-5901	Set of 2, Self-Retaining, One-Armed

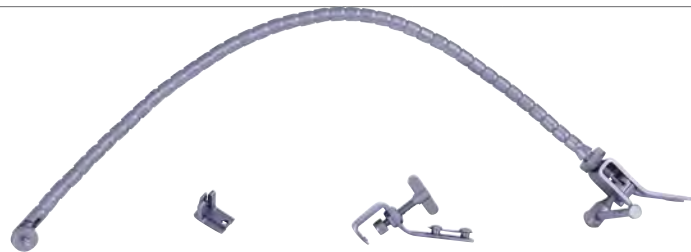

Leyla Brain Retractor

CODE	DESCRIPTION	WIDTH		LENGTH
57-5902	Set of 2, Self-Retaining, Two-Armed	$\frac{3}{8}$ in	10 mm	$6\frac{3}{4}$ in 170 mm

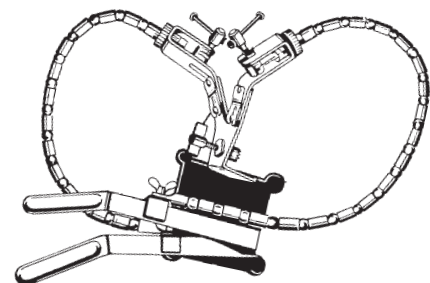

Retractors (Leyla)

Leyla Brain Retractor

CODE	DESCRIPTION	LENGTH
57-5930	Spatula Support	7 in 178 mm



Leyla Brain Retractor

CODE	DESCRIPTION
57-5921	Fixation Base, For One Arm Only
57-5922	Fixation Base, For Double Arm



57-5921

Leyla Brain Retractor

CODE	DESCRIPTION	WIDTH
57-5943	Ball Joint Clamp	1 in 26 mm



Leyla Brain Retractor

CODE	DESCRIPTION
57-5942	Coupling Head to Hold Flexible Arms



Retractors (Malis®)



50-1460

Malis® Brain Retractor Kit

Black Anodized, Attaches to the Malis® Cerebellar Retractor (50-1465)

CODE	DESCRIPTION	QTY	LENGTH	WIDTH
50-1460	Includes one each of the five blades and three extensions listed below:			
	Blade	1	3 in 76 mm	$\frac{3}{8}$ in 10 mm
	Blade	1	3 in 76 mm	$\frac{9}{16}$ in 14 mm
	Blade	1	3 in 76 mm	$\frac{5}{8}$ in 16 mm
	Blade	1	3 in 76 mm	$\frac{3}{4}$ in 19 mm
	Blade	1	3 in 76 mm	$\frac{3}{8}$ in 10 mm
	Retractor Extension	1	2 in 51 mm	
	Retractor Extension	1	3 in 76 mm	
	Retractor Extension	1	4 in 102 mm	
50-1454	Double Connector	2		

Malis® Cerebellar Retractor

4 x 4 Sharp Prongs, Self-Retaining, Angular Arms

CODE	DESCRIPTION	LENGTH
50-1465	Total Opening $5\frac{1}{2}$ in (140 mm), Post Height $1\frac{1}{2}$ in (38 mm), Prong Width $\frac{5}{8}$ in (16 mm), Prong Depth $\frac{7}{8}$ in (22 mm)	7 in 178 mm



Retractors (Malis®)

Malis® Connector

CODE	DESCRIPTION
50-1454	50-1460 Includes 2 of 50-1454



Malis® Hinge Clamp

CODE	DESCRIPTION
50-1453	Hinge Clamp



Retractors (Scalp)

Anderson-Adson Scalp Retractor

Total Opening 4 ½ in (114 mm)

CODE	BLADE WIDTH	BLADE DEPTH	LENGTH
50-1186	¾ in 19 mm	⅝ in 16 mm	7½ in 191 mm



Retractors (Scalp)

Cone Scalp Retractor

Self-Retaining with Hinged Arms

CODE	DESCRIPTION	LENGTH
50-1166	3 x 4 Blunt Prongs	5¾ in 146 mm



Contour Scalp Retractor

Angled Arms, 15 mm deep

CODE	DESCRIPTION	LENGTH
24-2670	3 x 4 Blunt Prongs	5½ in 140 mm
24-2671	3 x 4 Sharp Prongs	5½ in 140 mm



Jansen Scalp Retractor

CODE	DESCRIPTION	LENGTH
24-1310	3 x 3 Sharp Prongs	4 in 102 mm
24-1320	3 x 3 Blunt Prongs	4 in 102 mm
24-1321	4 x 4 Blunt Prongs	4¾ in 111 mm



Retractors (Self-Retaining)

Adson Retractor

Total Opening 5 in (127 mm), Shank Angle 65°

CODE	DESCRIPTION	DIMENSIONS
50-1362	3 x 3 Sharp Prongs	5 x 9½ in 127 x 241 mm



Alm Self-Retaining Retractor

CODE	DESCRIPTION	LENGTH
24-1007	4 x 4 Sharp Prongs	2¾ in 70 mm
24-1008	4 x 4 Blunt Prongs	2¾ in 70 mm
24-1011	4 x 4 Blunt Prongs	4 in 102 mm



24-1007

Retractors (Transsphenoidal)

Hardy™ Lip Retractor

CODE	DESCRIPTION
80-1337	Lip Retractor



Retractors (Vein)

Cushing Vein Retractor

CODE	TIP WIDTH	LENGTH	
20-1710	10 mm	8 in	203 mm
20-1712	12 mm	8 in	203 mm
20-1714	14 mm	8 in	203 mm
20-1718	18 mm	8 in	203 mm
20-1730	10 mm	9 ½ in	241 mm
20-1732	12 mm	9 ½ in	241 mm
20-1736	16 mm	9 ½ in	241 mm
20-1752	11 mm	14 in	356 mm



20-1710

Retractors (Vessel Supporter)

Malis® Vessel Supporter

Titanium Handle, Stainless Steel Shaft

CODE	DESCRIPTION	LENGTH	
80-1534	Two Prong	7 ¾ in	187 mm

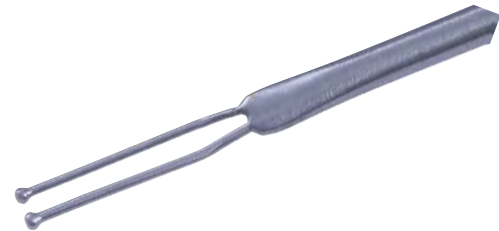

Retractors (Microsurgical)

Williams Retractor

CODE	DESCRIPTION	DIMENSIONS
80-1650	Right	50 x 10 mm Right
80-1651	Right	50 x 20 mm
80-1652	Right	70 x 10 mm
80-1653	Right	70 x 20 mm
80-1650S	Left	50 x 10 mm
80-1651S	Left	50 x 20 mm
80-1652S	Left	70 x 10 mm
80-1653S	Left	70 x 20 mm



80-1650

Rongeurs (Bone)

Beyer Rongeur

Double Action

CODE	DESCRIPTION	LENGTH	
53-1100	Curved, Double-Action	7 in	178 mm

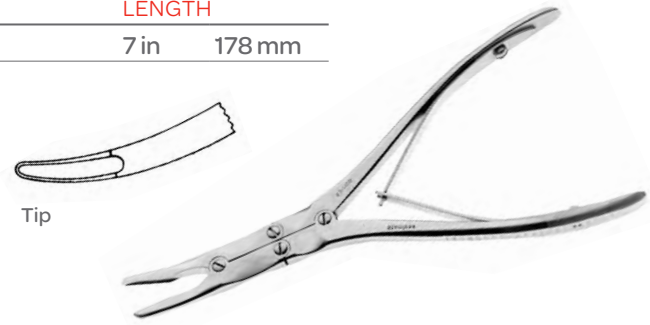

Friedman Bone Rongeur

Curved, Single Action

CODE	DESCRIPTION	LENGTH	
30-0514	Delicate, 4.0 mm Wide	5½ in	140 mm
30-0516	4.0 x 11 mm	5½ in	140 mm

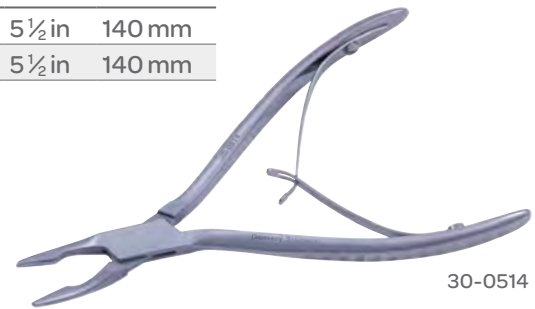

Lempert Rongeur

Single Action

CODE	DESCRIPTION	JAWS	LENGTH	
53-1108	Straight	2.0 mm	6⅞ in	156 mm
53-1102	Curved	2.0 mm	6⅞ in	156 mm
30-7620	Straight, Slender Pattern	2.5 mm	6¼ in	159 mm
30-7623	Curved, Slender Pattern	2.5 mm	6½ in	165 mm
30-7619	Straight	2.5 mm	7½ in	191 mm
30-7624	Straight, Slender Pattern	2.5 mm	7½ in	191 mm
30-7625	Curved, Slender Pattern	2.5 mm	7½ in	191 mm

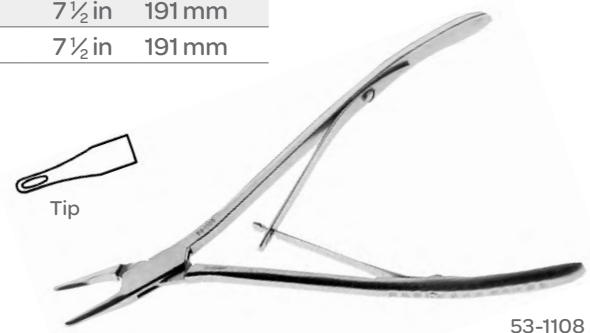

Rongeurs (Bone)

Luer Bone Rongeur

Single Action

CODE	DESCRIPTION	BITE	LENGTH	
30-5217	Straight	8.0 mm	7 in	178 mm
53-1011	Curved	6.0 mm	7 in	178 mm

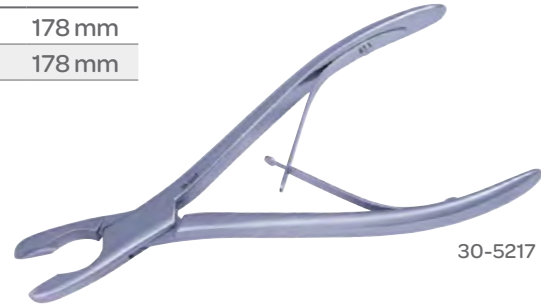

30-5217

Reiner Bone Rongeur

Single Action

CODE	DESCRIPTION	BITE	LENGTH	
53-1015	Curved	3.0 x 13 mm	7 in	178 mm
53-1016	Curved	4.0 x 14 mm	7 in	178 mm



53-1015

Reiner Rongeur

Single Action

CODE	DESCRIPTION	BITE	LENGTH	
30-7627	Rongeurs	4 mm	7 in	178 mm

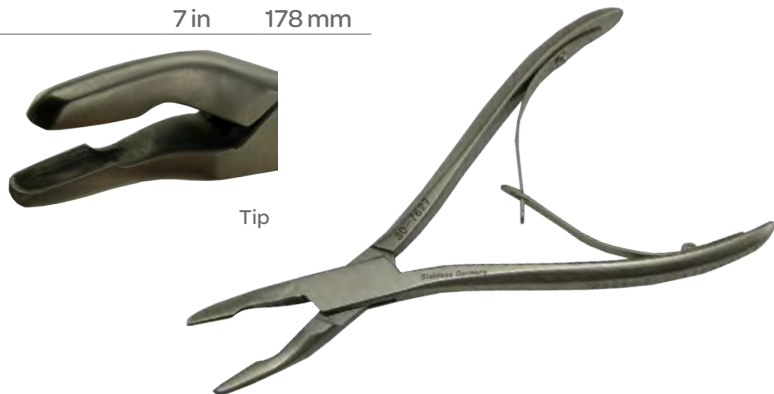

Tip

Rongeurs (Bone)

Ruskin Rongeur

Double Action

CODE	DESCRIPTION	BITE	LENGTH
53-1310	Straight	4 mm	7¼ in 184 mm
53-1312	Straight	5 mm	7¼ in 184 mm
53-1311	Curved	4 mm	7¼ in 184 mm
53-1313	Curved	5 mm	7¼ in 184 mm

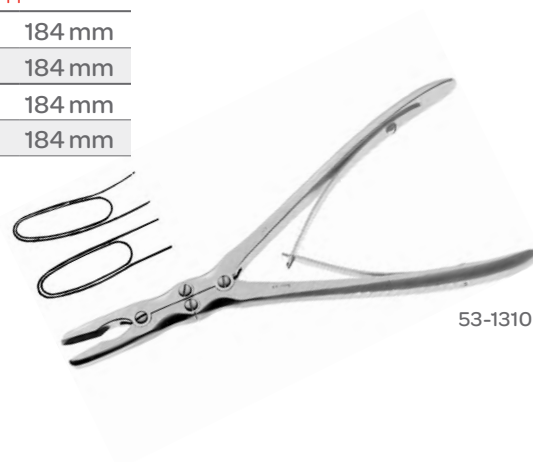

53-1310

Stille-Luer Rongeur

Double Action

CODE	DESCRIPTION	BITE	LENGTH
53-1130	Straight	10 mm	8½ in 216 mm
53-1131	Curved	10 mm	8½ in 216 mm
53-1118	Angular, Flat Lower Jaw	5 mm	9½ in 241 mm
53-1133	Angular	5 mm	9½ in 241 mm
67-7239		5 mm	11 in 279 mm
67-7240		10 mm	11 in 279 mm



67-7240

Zaufal-Jansen Rongeur

Double Action

CODE	DESCRIPTION	BITE	LENGTH
53-1095	Curved, Double-Action	4.0 x 30 mm	6¾ in 171 mm



Rongeurs (Cervical)

Micro Kerrison Rongeur

15 mm Opening

CODE	DESCRIPTION	BITE	LENGTH
57-0022-BD	40° Up	2 mm	8 in 203 mm
57-0023-BD	40° Up	3 mm	8 in 203 mm
57-0024-BD	40° Up	4 mm	8 in 203 mm
57-0025-BD	40° Up	5 mm	8 in 203 mm

Micro Kerrison Bayonet Rongeur

CODE	DESCRIPTION	BITE	LENGTH
56-1201-BD	90° Up	1 mm	6 in 160 mm
56-1202-BD	90° Up	2 mm	6 in 160 mm
56-1203-BD	90° Up	3 mm	6 in 160 mm
56-1204-BD	40° Up	4 mm	6 in 160 mm
56-1205-BD	40° Up	5 mm	6 in 160 mm



Rongeurs (Cervical)

Micro Kerrison Rongeur

Thin Footplate

CODE	DESCRIPTION	BITE	LENGTH
57-0721-BD	40° Up	1 mm	7 in 178 mm
57-0722-BD	40° Up	2 mm	7 in 178 mm
57-0723-BD	40° Up	3 mm	7 in 178 mm
57-0724-BD	40° Up	4 mm	7 in 178 mm
57-0725-BD	40° Up	5 mm	7 in 178 mm
57-0726-BD	40° Up	6 mm	7 in 178 mm
57-0701-BD	90° Up	1 mm	7 in 178 mm
57-0702-BD	90° Up	2 mm	7 in 178 mm
57-0703-BD	90° Up	3 mm	7 in 178 mm
57-0704-BD	90° Up	4 mm	7 in 178 mm
57-0705-BD	90° Up	5 mm	7 in 178 mm
57-0761-BD	40° Up	1 mm	8 in 203 mm
57-0762-BD	40° Up	2 mm	8 in 203 mm
57-0763-BD	40° Up	3 mm	8 in 203 mm
57-0764-BD	40° Up	4 mm	8 in 203 mm
57-0765-BD	40° Up	5 mm	8 in 203 mm
57-0766-BD	40° Up	6 mm	8 in 203 mm
57-0739-BD	90° Up	1 mm	8 in 203 mm
57-0740-BD	90° Up	2 mm	8 in 203 mm
57-0743-BD	90° Up	3 mm	8 in 203 mm
57-0744-BD	90° Up	4 mm	8 in 203 mm
57-0891-BD	40° Up	1 mm	9 in 228 mm
57-0892-BD	40° Up	2 mm	9 in 228 mm
57-0893-BD	40° Up	3 mm	9 in 228 mm
57-0894-BD	40° Up	4 mm	9 in 228 mm
57-0895-BD	40° Up	5 mm	9 in 228 mm
57-0896-BD	40° Up	6 mm	9 in 228 mm

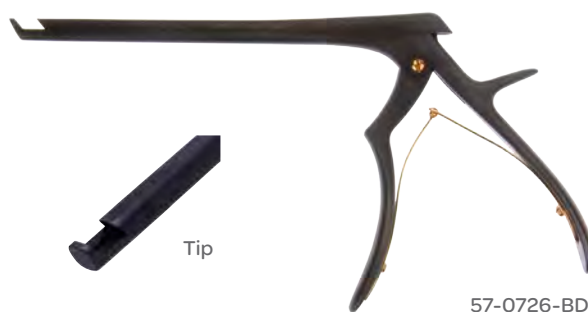

Rongeurs (Cervical)

Micro Kerrison Rongeur

Thin Footplate

CODE	DESCRIPTION	BITE	LENGTH
57-0801-BD	40° Down	1 mm	8 in 203 mm
57-0802-BD	40° Down	2 mm	8 in 203 mm
57-0803-BD	40° Down	3 mm	8 in 203 mm
57-0804-BD	40° Down	4 mm	8 in 203 mm
57-0751-BD	90° Down	1 mm	8 in 203 mm
57-0750-BD	90° Down	2 mm	8 in 203 mm
57-0752-BD	90° Down	3 mm	8 in 203 mm
57-0754-BD	90° Down	4 mm	8 in 203 mm



Micro Kerrison Rongeur With Ejector

9 mm Opening

CODE	DESCRIPTION	BITE	LENGTH
57-0392-BD	40° Up	2 mm	7 in 178 mm
57-0393-BD	40° Up	3 mm	7 in 178 mm
57-0394-BD	40° Up	4 mm	7 in 178 mm
57-0395-BD	40° Up	5 mm	7 in 178 mm
57-0692-BD	40° Up	2 mm	8 in 203 mm
57-0693-BD	40° Up	3 mm	8 in 203 mm
57-0694-BD	40° Up	4 mm	8 in 203 mm
57-0695-BD	40° Up	5 mm	8 in 203 mm
57-0696-BD	40° Up	6 mm	8 in 203 mm



Rongeurs (Cervical)

Pituitary Bayonet Rongeur

CODE	DESCRIPTION	BITE	LENGTH
56-2112-BD	Straight, 2 x 8 mm	1 mm	6 in 160 mm
56-2114-BD	Straight, 4 x 10 mm	2 mm	6 in 160 mm
56-2116-BD	Angled Up, 2 x 8 mm	3 mm	6 in 160 mm



Spurling Kerrison Rongeur

15 mm Opening

CODE	DESCRIPTION	BITE	LENGTH
57-0582-BD	40° Up	2 mm	8 in 203 mm
57-0583-BD	40° Up	3 mm	8 in 203 mm
57-0584-BD	40° Up	4 mm	8 in 203 mm
57-0585-BD	40° Up	5 mm	8 in 203 mm



Caspar IVD Rongeur

CODE	DESCRIPTION	BITE	JAWS
57-2912	Straight	2 x 12 mm	6 ¼ in 159 mm
57-2913	Straight	3 x 12 mm	6 ¼ in 159 mm
57-2915	Straight	5 x 12 mm	6 ¼ in 159 mm
57-2901	Straight	2 x 12 mm	7 ¼ in 184 mm
57-2902	Straight	3 x 12 mm	7 ¼ in 184 mm
57-2903	Straight	4 x 12 mm	7 ¼ in 184 mm
57-2904	Straight	5 x 12 mm	7 ¼ in 184 mm



Rongeurs (Cervical)

Caspar Rongeur

CODE	DESCRIPTION	BITE	LENGTH
57-2946	Down	3 mm	6 in 152 mm
57-2919	Angled Up	5 x 14 mm	6¼ in 159 mm
57-2921	Angled Down	4 x 14 mm	6¼ in 159 mm
57-2905	Angled Up	3 x 12 mm	7½ in 190 mm
57-2910	Up	2 x 12 mm	7¼ in 184 mm
57-2920-1	Angled Down	2 x 12 mm	7¼ in 184 mm
57-2906	Angled Up	4 x 14 mm	7½ in 190 mm
57-2908	Angled Down	5 x 14 mm	7½ in 190 mm



57-2946

Caspar Rongeur

Black Diamond

CODE	DESCRIPTION	BITE	LENGTH
57-2901-BD	Straight	2 x 12 mm	7¼ in 184 mm
57-2903-BD	Straight	4 x 14 mm	7¼ in 184 mm
57-2922-BD	Straight	2 x 12 mm	9 in 228 mm
57-2930-BD	Down	2 x 12 mm	9 in 228 mm



57-2930-BD

Classic® Thin Footplate Cervical Rongeur

Thin Footplate

CODE	DESCRIPTION	BITE	LENGTH
53-1537	Angle 40° Up	1.0 mm	
53-1539	Angle 40° Up	1.0 mm	
53-1500C	Angle 40° Up	2.0 mm	6 in 152 mm
53-1503	Angle 40° Up	3.0 mm	6 in 152 mm
53-1506	Angle 40° Up	4.0 mm	6 in 152 mm
53-1509	Angle 40° Up	5.0 mm	6 in 152 mm
53-1512	Angle 40° Up	2.0 mm	7 in 178 mm
53-1515	Angle 40° Up	3.0 mm	7 in 178 mm
53-1518	Angle 40° Up	4.0 mm	7 in 178 mm
53-1521	Angle 40° Up	5.0 mm	7 in 178 mm
53-1524	Angle 40° Up	2.0 mm	8 in 203 mm
53-1527	Angle 40° Up	3.0 mm	8 in 203 mm
53-1530	Angle 40° Up	4.0 mm	8 in 203 mm
53-1533	Angle 40° Up	5.0 mm	8 in 203 mm



57-1537

Rongeurs (Cervical)

Classic® Thin Footplate Cervical Rongeur

Thin footplate designed to easily fit under the cervical lamina. Gold screw for easy identification of thin footplate. Bite size is identified below gold screw. Hardy™ style handle with ball spring.

CODE	DESCRIPTION	BITE	LENGTH
53-1501	Angle 90° Up	2.0 mm	6 in 152 mm
53-1504	Angle 90° Up	3.0 mm	6 in 152 mm
53-1507	Angle 90° Up	4.0 mm	6 in 152 mm
53-1510	Angle 90° Up	5.0 mm	6 in 152 mm
53-1502	Angle 90° Down	2.0 mm	6 in 152 mm
53-1505	Angle 90° Down	3.0 mm	6 in 152 mm
53-1508	Angle 90° Down	4.0 mm	6 in 152 mm
53-1511	Angle 90° Down	5.0 mm	6 in 152 mm
53-1513	Angle 90° Up	2.0 mm	7 in 178 mm
53-1516	Angle 90° Up	3.0 mm	7 in 178 mm
53-1519	Angle 90° Up	4.0 mm	7 in 178 mm
53-1522	Angle 90° Up	5.0 mm	7 in 178 mm
53-1514	Angle 90° Down	2.0 mm	7 in 17.8 cm
53-1517	Angle 90° Down	3.0 mm	7 in 17.8 cm
53-1520	Angle 90° Down	4.0 mm	7 in 17.8 cm
53-1523	Angle 90° Down	5.0 mm	7 in 17.8 cm
53-1525	Angle 90° Up	2.0 mm	8 in 203 mm
53-1528	Angle 90° Up	3.0 mm	8 in 203 mm
53-1531	Angle 90° Up	5.0 mm	8 in 203 mm
53-1534	Angle 90° Up	5.0 mm	8 in 203 mm
53-1526	Angle 90° Down	2.0 mm	8 in 203 mm
53-1529	Angle 90° Down	3.0 mm	8 in 203 mm
53-1532	Angle 90° Down	4.0 mm	8 in 203 mm
53-1535	Angle 90° Down	5.0 mm	8 in 203 mm

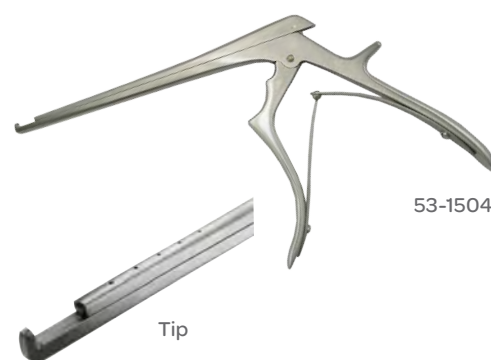

Cloward-Style Rongeur

CODE	DESCRIPTION	BITE	LENGTH
57-2456	Angled Up, Serrated	4 x 10 mm	6 in 152 mm

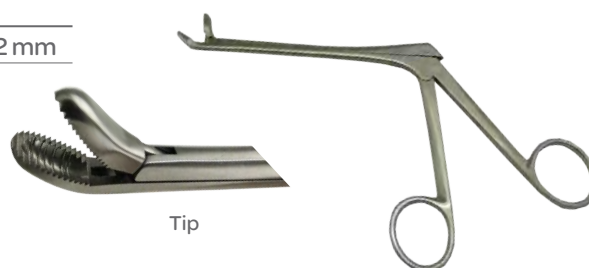

Rongeurs (Cervical)

Cushing IVD Rongeur

CODE	DESCRIPTION	BITE	LENGTH
57-2002	Straight	2 x 10 mm	5 in 127 mm
57-2032	Angled Up	2 x 10 mm	5 in 127 mm
57-2062	Angled Down	2 x 10 mm	5 in 127 mm
57-2012	Straight	2 x 10 mm	6 in 152 mm
57-2042	Angled Up	2 x 10 mm	6 in 152 mm
57-2022	Straight	2 x 10 mm	7 in 178 mm
57-2122	Straight, With Teeth	2 x 10 mm	7 in 178 mm
57-2052	Angled Up	2 x 10 mm	7 in 178 mm
57-2152	Angled Up, With Teeth	2 x 10 mm	7 in 178 mm
57-2082	Angled Down	2 x 10 mm	7 in 178 mm
57-2182	Angled Down, With Teeth	2 x 10 mm	7 in 178 mm
57-2060	Straight	2 x 10 mm	9 in 229 mm
57-2063	Angled Up	2 x 10 mm	9 in 229 mm
57-2065	Angled Down	2 x 10 mm	9 in 229 mm



Cushing Rongeur Delicate

CODE	DESCRIPTION	BITE	LENGTH
57-2000	Up	1.5 mm	7 in 178 mm
57-1999	Down	1.5 mm	7 in 178 mm
57-2001	Straight	1.5 mm	7 in 178 mm
57-1997	Up	1.5 mm	9 in 229 mm
57-1998	Straight	1.5 mm	9 in 229 mm



Decker Rongeur

CODE	DESCRIPTION	LENGTH
57-2097	Angled up, 1.5 x 5 mm Cups	5 ½ in 138 mm
57-2098	Straight, 1.5 x 5 mm Cups	5 ½ in 138 mm
57-2099	Angled Down, 1.5 x 5 mm Cups	5 ½ in 138 mm
57-2100	Curved Left, 1.5 x 5 mm Cups	5 ½ in 138 mm

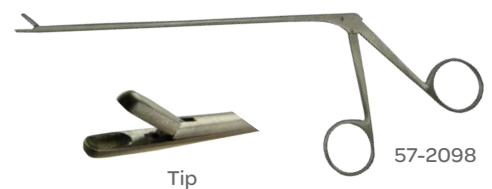

Rongeurs (Cervical)

Del IVD Rongeur

CODE	DESCRIPTION	BITE	LENGTH
57-2330	Straight	3 x 10 mm	6 in 152 mm
57-2331	Angled Up	3 x 10 mm	6 in 152 mm
57-2332	Down	3 x 10 mm	6 in 152 mm



57-2332

Detachable Cervical Rongeur

CODE	DESCRIPTION	BITE	LENGTH
53-1544	Angle 40° Up	3.0 mm	7 in 178 mm
53-1546	Angle 40° Up	4.0 mm	7 in 178 mm

Ferris Smith Kerrison Rongeur

Down Biting

CODE	DESCRIPTION	BITE	LENGTH
57-1011		1 mm	7 in 178 mm
57-1020	40° Up	2 mm	7 in 178 mm

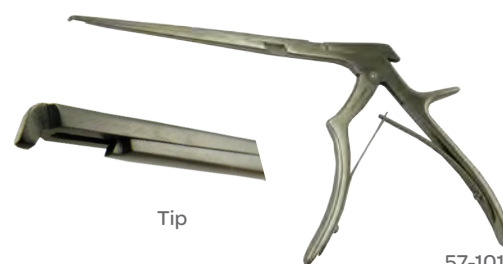

57-1011

Ferris Smith IVD Rongeur

CODE	DESCRIPTION	BITE	LENGTH
57-1015	40° Up	5 mm	7 in 178 mm
57-1035	90° Down	5 mm	7 in 178 mm



57-1015

Ferris-Smith IVD Rongeur

CODE	DESCRIPTION	BITE	LENGTH
57-1320	Up	2 x 10 mm	7 in 178 mm
57-1330	Up	3 x 10 mm	7 in 178 mm
57-1340	Up	4 x 10 mm	7 in 178 mm
57-1420	Down	2 x 10 mm	7 in 178 mm
57-1430	Down	3 x 10 mm	7 in 178 mm
57-1440	Down	4 x 10 mm	7 in 178 mm



57-1330

Rongeurs (Cervical)

Ferris-Smith Spurling IVD Rongeur

CODE	DESCRIPTION	BITE	LENGTH
57-1219	Straight	4 x 8 mm	7 in 178 mm
57-1220	Straight	2 x 10 mm	7 in 178 mm
57-1230	Straight	3 x 10 mm	7 in 178 mm
57-1240	Straight	4 x 10 mm	7 in 178 mm
57-1260	Straight	6 x 10 mm	7 in 178 mm



57-1219

Hoen IVD Rongeur

CODE	DESCRIPTION	BITE	LENGTH
57-2450	Fenestrated, 1 x 2 Teeth	4 mm	5½ in 138 mm
57-2095	Straight, 1 x 2 Teeth	4 mm	5½ in 138 mm



57-2095

Kerrison Rongeur

CODE	DESCRIPTION	BITE	LENGTH
57-1100	Curved Up	2 mm	8 in 203 mm
57-1102	Curved Up	3 mm	8 in 203 mm
57-1104	Curved Up	4 mm	8 in 203 mm
57-1105	Curved Up	5 mm	8 in 203 mm



57-1105

Rongeurs (Cervical)

Love-Gruenwald IVD Rongeur

CODE	DESCRIPTION	BITE	LENGTH
57-2013	Up	3 x 10 mm	6 in 152 mm
57-2014	Down	3 x 10 mm	6 in 152 mm
57-2066	Straight, With Teeth	3 x 10 mm	7 in 178 mm
57-2070	Straight	3 x 10 mm	9 in 229 mm
57-2073	Angled Up	3 x 10 mm	9 in 229 mm
57-2075	Angled Down	3 x 10 mm	9 in 229 mm



Love Gruenwald IVD Rongeur

CODE	DESCRIPTION	BITE	LENGTH
57-2103	Straight	3 x 10 mm	5 in 127 mm
57-2133	Angled Up	3 x 10 mm	5 in 127 mm
57-2163	Angled Down	3 x 10 mm	5 in 127 mm
57-2123	Straight	3 x 10 mm	7 in 178 mm
57-2153	Angled Up	3 x 10 mm	7 in 178 mm
57-2183	Angled Down	3 x 10 mm	7 in 178 mm



Micro Kerrison Bayonet Rongeur

CODE	DESCRIPTION	BITE	LENGTH
56-1001-BD	40° Up	1 mm	6 in 160 mm
56-1002-BD	40° Up	2 mm	6 in 160 mm
56-1003-BD	40° Up	3 mm	6 in 160 mm
56-1004-BD	40° Up	4 mm	6 in 160 mm
56-1005-BD	40° Up	5 mm	6 in 160 mm
56-1032	40° Up, Right	2 mm	7 in 180 mm
56-1033	40° Up, Right	3 mm	7 in 180 mm



Rongeurs (Cervical)

Micro Kerrison Ejector Rongeur

9 mm Opening

CODE	DESCRIPTION	BITE	LENGTH
57-0692	40°	2 mm	8 in 203 mm
57-0693	40°	3 mm	8 in 203 mm
57-0694	40°	4 mm	8 in 203 mm
57-0695	40°	5 mm	8 in 203 mm
57-0696	40°	6 mm	8 in 203 mm



Micro Kerrison Rongeur

9 mm Opening, With Ejector-Thin Footplate

CODE	DESCRIPTION	BITE	LENGTH
57-0392	40° Up	2 mm	7 in 178 mm
57-0393	40° Up	3 mm	7 in 178 mm
57-0394	40° Up	4 mm	7 in 178 mm
57-0395	40° Up	5 mm	7 in 178 mm



Micro Kerrison T-Bar Ejector Rongeur

9 mm Opening, Small Handle

CODE	DESCRIPTION	BITE	LENGTH
57-0852	40° Up	2.5 mm	8 in 203 mm
57-0853	40° Up	3 mm	8 in 203 mm
57-0854	40° Up	4 mm	8 in 203 mm
57-0855	40° Up	5 mm	8 in 203 mm



Rongeurs (Cervical)

Micro Kerrison Rongeur

15 mm Opening, Gold Screw

CODE	DESCRIPTION	BITE	LENGTH
57-0763.15	40° Up	3 mm	8 in 203 mm
57-0764.15	40° Up	4 mm	8 in 203 mm
57-0765.15	40° Up	5 mm	8 in 203 mm

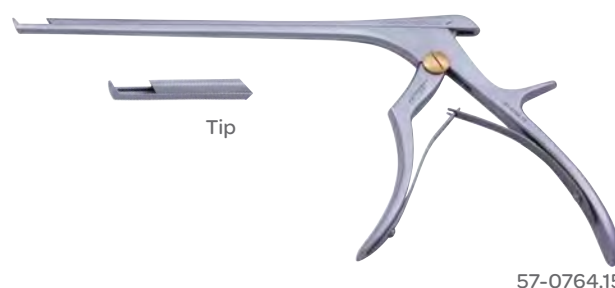

Micro Kerrison Rongeur

15 mm Opening, Small Handle

CODE	DESCRIPTION	BITE	LENGTH
57-0022	40° Up	2 mm	8 in 203 mm
57-0023	40° Up	3 mm	8 in 203 mm
57-0024	40° Up	4 mm	8 in 203 mm
57-0025	40° Up	5 mm	8 in 203 mm



Micro Kerrison Rongeur

15 mm Opening, Small Opening, Ultra Coat

CODE	DESCRIPTION	BITE	LENGTH
57-0022UC	40° Up	2 mm	8 in 203 mm
57-0024UC	40° Up	4 mm	8 in 203 mm

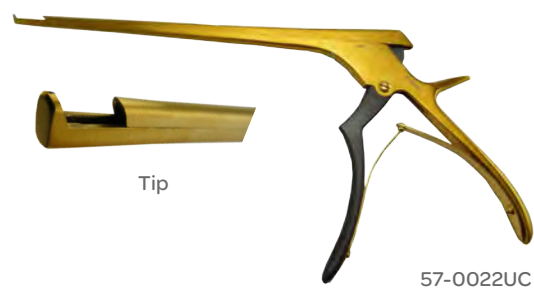

Rongeurs (Cervical)

Micro Kerrison Rongeur

Thin Footplate

CODE	DESCRIPTION	BITE	LENGTH
57-0603	40° Up	3 mm	6 in 160 mm
57-0604	40° Up	4 mm	6 in 160 mm
57-0605	40° Up	3 mm	6 in 160 mm
57-0721	40° Up	1 mm	7 in 178 mm
57-0722	40° Up	2 mm	7 in 178 mm
57-0723	40° Up	3 mm	7 in 178 mm
57-0724	40° Up	4 mm	7 in 178 mm
57-0725	40° Up	5 mm	7 in 178 mm
57-0701	90° Up	1 mm	7 in 178 mm
57-0702	90° Up	2 mm	7 in 178 mm
57-0703	90° Up	3 mm	7 in 178 mm
57-0704	90° Up	4 mm	7 in 178 mm
57-0705	90° Up	5 mm	7 in 178 mm
57-0761	40° Up	1 mm	8 in 203 mm
57-0762	40° Up	2 mm	8 in 203 mm
57-0763	40° Up	3 mm	8 in 203 mm
57-0764	40° Up	4 mm	8 in 203 mm
57-0765	40° Up	5 mm	8 in 203 mm
57-0766	40° Up	6 mm	8 in 203 mm
57-0739	90° Up	1 mm	8 in 203 mm
57-0740	90° Up	2 mm	8 in 203 mm
57-0743	90° Up	3 mm	8 in 203 mm
57-0744	90° Up	4 mm	8 in 203 mm
57-0745	90° Up	5 mm	8 in 203 mm
57-0746	90° Up	6 mm	8 in 203 mm
57-0891	40° Up	1 mm	9 in 228 mm
57-0892	40° Up	2 mm	9 in 228 mm
57-0893	40° Up	3 mm	9 in 228 mm
57-0894	40° Up	4 mm	9 in 228 mm
57-0895	40° Up	5 mm	9 in 228 mm
57-0896	40° Up	6 mm	9 in 228 mm
57-0901	90° Up	1 mm	9 in 228 mm
57-0902	90° Up	2 mm	9 in 228 mm
57-0903	90° Up	3 mm	9 in 228 mm
57-0905	90° Up	5 mm	9 in 228 mm
57-0101	40° Up	1 mm	10 in 254 mm
57-0102	40° Up	2 mm	10 in 254 mm
57-0103	40° Up	3 mm	10 in 254 mm
57-0104	40° Up	4 mm	10 in 254 mm
57-0105	40° Up	5 mm	10 in 254 mm



57-0603



Tip

Rongeurs (Cervical)

Micro Kerrison Rongeur

Thin Footplate

CODE	DESCRIPTION	BITE	LENGTH
57-0712	90° Down	2 mm	7 in 178 mm
57-0713	90° Down	3 mm	7 in 178 mm
57-0714	90° Down	4 mm	7 in 178 mm
57-0750	90° Down	2 mm	8 in 203 mm
57-0752	90° Down	3 mm	8 in 203 mm
57-0754	90° Down	4 mm	8 in 203 mm
57-0755	90° Down	5 mm	8 in 203 mm
57-0756	90° Down	6 mm	8 in 203 mm

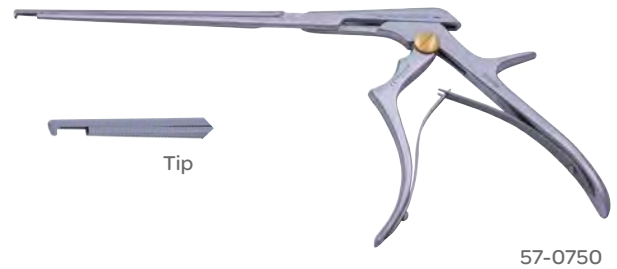

57-0750

Micro Kerrison Rongeur

Ultra Coat

CODE	DESCRIPTION	BITE	LENGTH
57-0761UC	40° Up	1 mm	8 in 203 mm
57-0762UC	40° Up	2 mm	8 in 203 mm
57-0763UC	40° Up	3 mm	8 in 203 mm
57-0764UC	40° Up	4 mm	8 in 203 mm
57-0765UC	40° Up	5 mm	8 in 203 mm
57-0892UC	40° Up	2 mm	9 in 228 mm
57-0893UC	40° Up	3 mm	9 in 228 mm
57-0894UC	40° Up	4 mm	9 in 228 mm
57-0895UC	40° Up	5 mm	9 in 228 mm



57-0893UC

Oldberg Rongeur

CODE	DESCRIPTION	CUP	LENGTH
57-2296		6 mm	7 in 178 mm



Tip

Peapod IVD Rongeur

CODE	DESCRIPTION	BITE	LENGTH
57-2090	Angled Up	2.5 mm	5 ½ in 138 mm
57-2092	Angled Up	3 mm	5 ½ in 138 mm
57-2094	Angled Up	4 mm	5 ½ in 138 mm



Tip

57-2090

Rongeurs (Cervical)

RapidClean® Detachable Cervical Kerrison Rongeur

CODE	DESCRIPTION	BITE	LENGTH
531540CD	Detachable, 40° Up	1 mm	7 in 180 mm
531542CD	Detachable, 40° Up	2 mm	7 in 180 mm
531544CD	Detachable, 40° Up	3 mm	7 in 180 mm
531546CD	Detachable, 40° Up	4 mm	7 in 180 mm
531570CD	Detachable, 40° Up	1 mm	8 in 200 mm
531572CD	Detachable, 40° Up	2 mm	8 in 200 mm
531574CD	Detachable, 40° Up	3 mm	8 in 200 mm
531576CD	Detachable, 40° Up	4 mm	8 in 200 mm
531548CD	Detachable, 40° Up	1 mm	9 in 230 mm
531550CD	Detachable, 40° Up	2 mm	9 in 230 mm
531552CD	Detachable, 40° Up	3 mm	9 in 230 mm
531554CD	Detachable, 40° Up	4 mm	9 in 230 mm

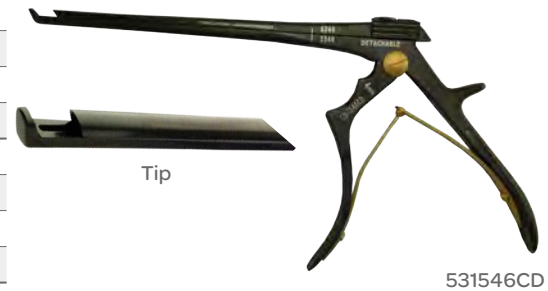

Schlesinger IVD Rongeur

CODE	DESCRIPTION	BITE	LENGTH
57-2435	Angled Up	3 x 10 mm	5 in 127 mm
57-2432	Straight	2 x 10 mm	6 in 152 mm
57-2433	Straight	3 x 10 mm	6 in 152 mm
57-2434	Straight	4 x 10 mm	6 in 152 mm



Selverstone IVD Rongeur

CODE	DESCRIPTION	LENGTH
57-1255	2 x 3 mm Cup	6 in 152 mm
57-1262	2 x 3 mm Cup	6 in 152 mm



Spurling IVD Rongeur

with Teeth

CODE	DESCRIPTION	BITE	LENGTH
57-2300	Straight	4 x 10 mm	7 in 178 mm
57-2301	Angled Up	4 x 10 mm	7 in 178 mm
57-2302	Angled Down	4 x 10 mm	7 in 178 mm



Rongeurs (Cervical)

Spurling Kerrison Rongeur

Ultra Coat

CODE	DESCRIPTION	BITE	LENGTH
57-0582UC	40° Up	2 mm	8 in 203 mm
57-0583UC	40° Up	3 mm	8 in 203 mm
57-0584UC	40° Up	4 mm	8 in 203 mm
57-0585UC	40° Up	5 mm	8 in 203 mm



57-0582UC

Spurling Kerrison Rongeur

15 mm Opening, Large Handle

CODE	DESCRIPTION	BITE	LENGTH
57-0543	90° Down	5 mm	7 in 178 mm
57-0203	90° Up	3 mm	6 in 160 mm
57-0544	90° Down	3 mm	6 in 160 mm
57-0545	90° Down	4 mm	6 in 160 mm
57-0552	40° Up	2 mm	7 in 178 mm
57-0553	40° Up	3 mm	7 in 178 mm
57-0554	40° Up	4 mm	7 in 178 mm
57-0556	40° Up	6 mm	7 in 178 mm
57-0533	90° Up	3 mm	7 in 178 mm
57-0534	90° Up	4 mm	7 in 178 mm
57-0535	90° Up	5 mm	7 in 178 mm
57-0536	90° Up	6 mm	7 in 178 mm
57-0582	40° Up	2 mm	8 in 203 mm
57-0583	40° Up	3 mm	8 in 203 mm
57-0584	40° Up	4 mm	8 in 203 mm
57-0585	40° Up	5 mm	8 in 203 mm
57-0586	40° Up	6 mm	8 in 203 mm
57-0562	90° Up	2 mm	8 in 203 mm
57-0563	90° Up	3 mm	8 in 203 mm
57-0565	90° Up	4 mm	8 in 203 mm
57-0782	40° Up	2 mm	9 in 228 mm
57-0783	40° Up	3 mm	9 in 228 mm
57-0784	40° Up	4 mm	9 in 228 mm
57-0785	40° Up	5 mm	9 in 228 mm
57-0786	40° Up	6 mm	9 in 228 mm



57-0554

Rongeurs (IVD)

Spurling Kerrison Rongeur

CODE	DESCRIPTION	BITE	LENGTH
57-2204	Straight	4 x 10 mm	5 in 127 mm
57-2214	Straight	4 x 10 mm	6 in 152 mm
57-2244	Angled Up	4 x 10 mm	6 in 152 mm
57-2274	Angled Down	4 x 10 mm	6 in 152 mm
57-2224	Straight	4 x 10 mm	7 in 178 mm
57-2254	Angled Up	4 x 10 mm <td 7 in 178 mm	
57-2284	Angled Down	4 x 10 mm	7 in 178 mm
57-2270	Straight	4 x 10 mm	9 in 228 mm
57-2273	Angled Up	4 x 10 mm	9 in 228 mm
57-2275	Angled Down	4 x 10 mm	9 in 228 mm



57-2224

Wilde IVD Rongeur Micropak

Fenestrated Jaw

CODE	DESCRIPTION	BITE	LENGTH
57-2461	Straight	3 mm	5½ in 140 mm
57-2473	Straight	5 mm	7 in 178 mm
57-2477	Angled Up	4 mm	7 in 178 mm
57-2493	Straight	5 mm	9 in 228 mm



57-2461

Williams Discectomy IVD Rongeur

CODE	DESCRIPTION	LENGTH
57-2091	Up	5½ in 140 mm



Rongeurs (Bone)

Adson Cranial Rongeur

Single Action

CODE	DESCRIPTION	BITE	LENGTH
53-1040	Straight	8 mm	8 in 203 mm
30-5421	Straight	8 mm	8¼ in 210 mm
30-5423	Curved, 7.7 x 14 mm Cup	8 mm	8¼ in 210 mm



53-1040

Bacon Cranial Rongeur

Single Action

CODE	DESCRIPTION	BITE	LENGTH
53-1035	Angular	⅜ in 5 mm	8¼ in 210 mm



Stookey Cranial Rongeur

Single Action

CODE	DESCRIPTION	BITE	LENGTH
53-1055	Angular	3 mm	8¼ in 210 mm

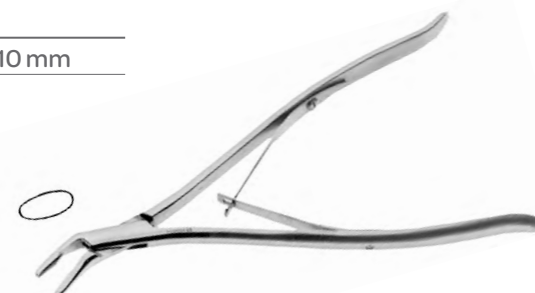

Rongeurs (Bone)

Echlin Laminectomy Rongeur

Double-Action

CODE	DESCRIPTION	BITE	LENGTH
53-1046	Angular	3 mm	8¾ in 222 mm
53-1047	Angular	4 mm	8¾ in 222 mm



Fulton Laminectomy Rongeur

Narrow Blade, Double-Action, Cup Size 15 x 16 mm

CODE	DESCRIPTION	LENGTH
53-1060	Straight	7½ in 191 mm
53-1061	Slightly Curved	7½ in 191 mm
53-1066	Straight	9½ in 241 mm



Leksell Laminectomy Rongeur

Double-Action

CODE	DESCRIPTION	BITE	LENGTH
53-1127	Regular Curve, Narrow Jaw	5 mm	9 in 229 mm
53-1125	Regular Curve, Wide Jaw	8 mm	9 in 229 mm
53-1128	Full Curve, Narrow Jaw	5 mm	9 in 229 mm
53-1126	Full Curve, Wide Jaw	8 mm	9 in 229 mm

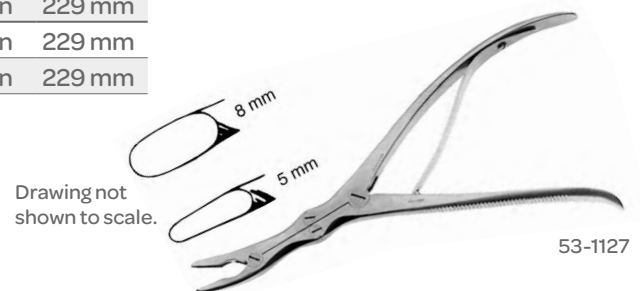

Leksell Rongeur

Double Action

CODE	DESCRIPTION	BITE	LENGTH
67-7913	Full Curve	2 mm	14 in 356 mm
67-7914	Full Curve	3 mm	14 in 356 mm
67-7915	Full Curve	4 mm	14 in 356 mm
67-7916	Full Curve	5 mm	14 in 356 mm
67-7917	Full Curve	6 mm	14 in 356 mm



Rongeurs (Laminectomy)

Lempert Rongeur

CODE	DESCRIPTION	LENGTH
30-7622	Curved, Slender Pattern	6 ¼ in 159 mm



MicroSect® Shavers

CODE	DESCRIPTION	SHAFT
47-5030	45° Up 1.5 mm	8 ½ in 216 mm
47-5031	45° Up 2.0 mm	8 ½ in 216 mm
47-5032	45° Up 2.5 mm	8 ½ in 216 mm
47-5033	45° Up 3.0 mm	8 ½ in 216 mm
47-5034	45° Up 4.0 mm	8 ½ in 216 mm



Smith-Peterson Laminectomy Rongeur

Single Action

CODE	DESCRIPTION	LENGTH
53-1080	Straight, 4 x 15 mm	7 ½ in 191 mm
53-1081	Slightly Curved, 4 x 15 mm	7 ½ in 191 mm
53-1083	Straight	9 ½ in 241 mm
53-1084	Slightly Curved	9 ½ in 241 mm
53-1085	Full Curve	9 ½ in 241 mm



Spurling-Kerrison Rongeur

CODE	DESCRIPTION	LENGTH
32-3426	Bite 3 mm, Up Cut 40°	8 in 203 mm



Rongeurs (Micro)

Decker Micro Rongeur

Alligator Action

CODE	DESCRIPTION	BITE	LENGTH
53-4000	Straight	2 x 6 mm	6 in 152 mm
53-4002	Curved Left	2 x 6 mm	6 in 152 mm



53-4000

Micro Friedman Rongeur

CODE	DESCRIPTION	JAWS	LENGTH
30-0201	Straight, Very Delicate	1.5 mm	5 ½ in 140 mm
30-0202	Curved, Very Delicate	1.5 mm	5 ½ in 140 mm
30-0203	Straight, Delicate	2 mm	6 in 152 mm
30-0204	Curved, Delicate	2 mm	6 in 152 mm



30-0202

Micro Rongeur

Bayonet

CODE	DESCRIPTION	JAWS	LENGTH
46-2601	40° Up	1 mm	2 ¾ in 70 mm
46-2602	40° Up	2 mm	2 ¾ in 70 mm
46-2603	40° Up	3 mm	2 ¾ in 70 mm



46-2601

Rongeurs (Bone)

Cottle Jansen Rongeur

Single Action

CODE	DESCRIPTION	LENGTH
30-5312	Angled Jaws, 12 x 5 mm	6 ³ / ₄ in 171 mm

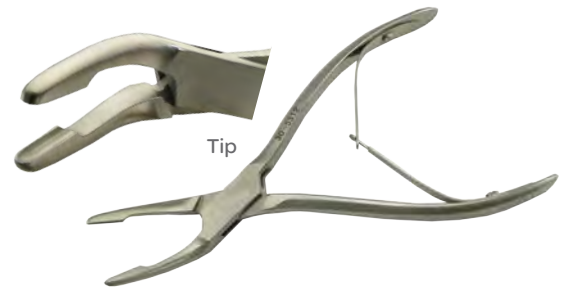

Cushing Rongeur

Single Action

CODE	DESCRIPTION	BITE	LENGTH
30-3185	Straight	6 mm	8 in 203 mm

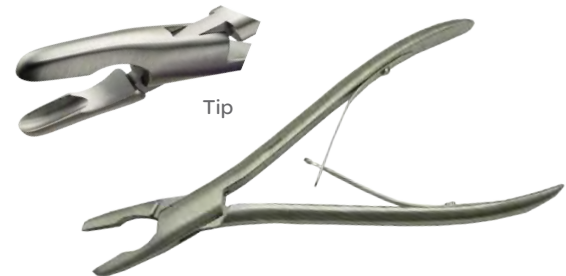

De Vilbiss Rongeur

Single Action

CODE	DESCRIPTION	LENGTH
53-1030	With One Extra Blade	8 ¹ / ₁₆ in 206 mm



Olivecrona Rongeur

Single Action

CODE	DESCRIPTION
31-0401	Curved Light



Saws (Guides)

Bailey Gigli Saw Guides

CODE	DESCRIPTION	LENGTH
14-1020	Straight	12 in 305 mm
14-1021	Curved	12 in 305 mm



14-1020

Poppen Saw Guide

CODE	DESCRIPTION	LENGTH
14-1025	Saw Guide	11 in 279 mm

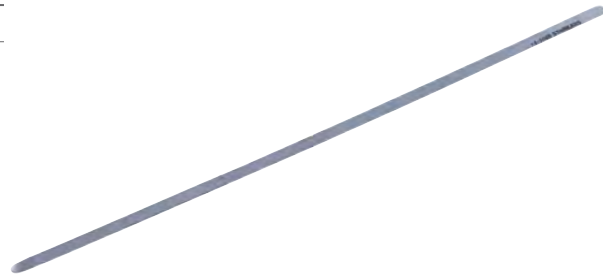

Saws (Handles)

Gigli Saw Handle

CODE	DESCRIPTION
57-6407	Loop Grip with Snap Lock

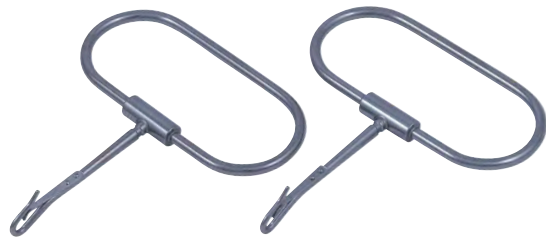

Gigli Saw Handle Loop

CODE	DESCRIPTION	LENGTH
11-1015	One Pair	1¾ in 44 mm



Saws (Handles)

Gigli Wire Handle

CODE	DESCRIPTION
57-6406	Loop Grip, Sold as Pair



Gigli Wire Saw Handle

CODE	DESCRIPTION
57-6402	Sold in Pairs

Gigli Wire Saw Handle

CODE	DESCRIPTION
57-6407L	Sold in Pairs, With Snap Lock



Strully Gigli Saw Handles

CODE	DESCRIPTION	LENGTH
11-1020C	Loop, One Pair	3¼ in 83 mm
11-1021C	Solid, One Pair	3½ in 89 mm



11-1021C

Saws (Wire)

Gigli (Olivecrona) Wire Saw

CODE	LENGTH
57-6430	11 ³ / ₄ in 298 mm
57-6450	19 ³ / ₄ in 502 mm
57-6460	23 ³ / ₄ in 603 mm
57-6470	27 ¹ / ₂ in 699 mm

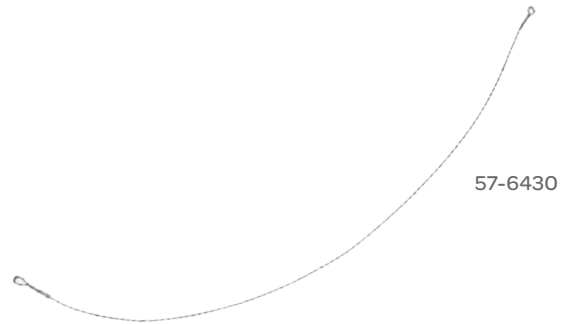

57-6430

Gigli Twisted Wire Saw

Package of 10

CODE	LENGTH
75-1003	12 in 305 mm
75-1004 Package of 10	20 in 508 mm

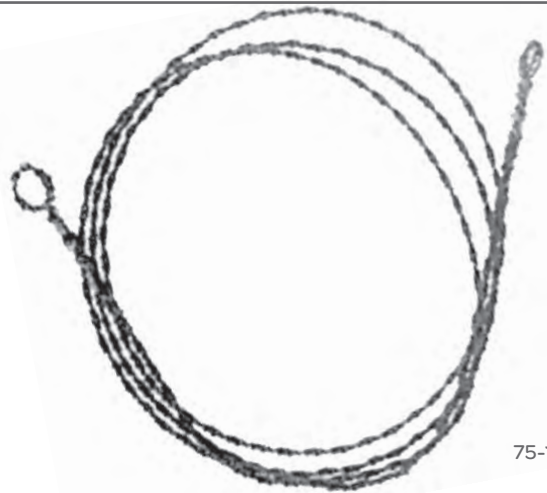

75-1004

Olivecrona-Gigli Wire Saw

Stille Type, Package of 10

CODE	LENGTH
75-1018	12 in 305 mm
75-1019	16 in 406 mm
75-1020	20 in 508 mm

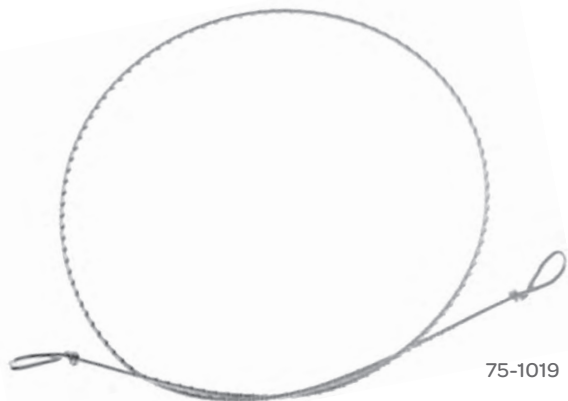

75-1019

Saws (Wire)

Tyler-Gigli Wire Saw

Package of 10

CODE	DESCRIPTION	LENGTH	
75-1013	Large Cut	12 in	305 mm
75-1012	Large Cut	20 in	508 mm

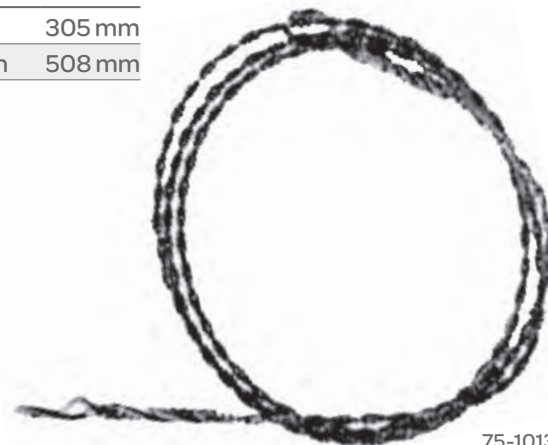

75-1013

Scissors (Bayonet)

Malis® Bayonet Scissors

Flat Handle, Titanium

CODE	DESCRIPTION	WORKING LENGTH		LENGTH	
58-5451T	Straight, Fine Tip	3¾ in	95 mm	9½ in	241 mm
58-5450T	Straight, Regular Tip	3¾ in	95 mm	9½ in	241 mm
58-5454T	Curved Up, Regular Tip	3¾ in	95 mm	9½ in	241 mm



58-5454T

Yasargil Bayonet Scissors

Flat Bayonet Handle

CODE	DESCRIPTION	LENGTH	
58-1929	125° Reverse Angle	7½ in	181 mm
58-1920	Straight	7½ in	191 mm
58-1921	Curved	7½ in	191 mm
58-1931	Curved	8¾ in	222 mm

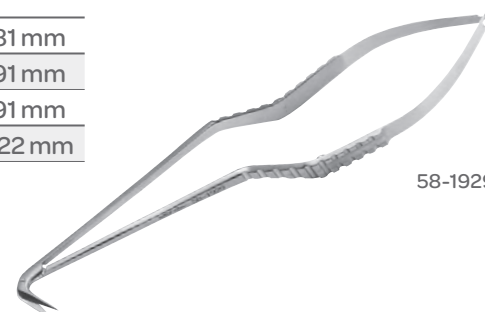

58-1929

Scissors (Dural)

Frazier Dural Scissors

CODE	DESCRIPTION	LENGTH
57-2516	Angled, One Blade Has Probe Tip	6½ in 165 mm
54-1055	Angled, One Blade Has Probe Tip	6¾ in 171 mm



57-2516

Taylor Dural Scissors

CODE	DESCRIPTION	LENGTH
54-1050	Dural Scissors	5¾ in 146 mm



Scissors (Ganglion)

Adson Ganglion Scissors

CODE	DESCRIPTION	LENGTH
54-1005	Straight, Sharp/Sharp	6¼ in 159 mm
54-1006	Curved, Sharp/Sharp	6¼ in 159 mm



54-1005

Scissors (Micro)

Scissors

Titanium, Serrated Jaws

CODE	DESCRIPTION	LENGTH
80-6008	Straight, Fine Tip	6 in 152 mm
80-6009	Straight, Regular Tip	6 in 152 mm



XF Scissors

Titanium, Extra Fine

CODE	DESCRIPTION	LENGTH
80-6640	Straight	6 in 152 mm
80-6642	Straight Blade, 60° Angle	6 in 152 mm
80-6641	Curved	6 in 152 mm



Micro Scissors

Titanium

CODE	DESCRIPTION	LENGTH
80-2005	Straight	5½ in 140 mm
58-2108B	Straight, Bayonet, Blunt Blade	10¼ in 260 mm
80-2006	Curved Tip	5½ in 140 mm
58-2109B	Curved Up, Bayonet, Blunt Blade	10¼ in 260 mm

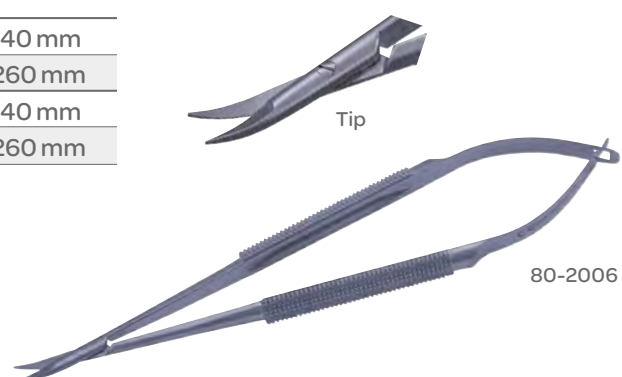

Scissors (Micro Bayonet)

Micro Bayonet Scissors

Serrated Blade

CODE	DESCRIPTION	LENGTH
57-2610	Straight, Fine Handle	9¼ in 235 mm
57-2720	Straight, Blunt	9¼ in 235 mm



57-2720

Rhoton® Micro Bayonet Scissors

CODE	DESCRIPTION	LENGTH
59-5932	Straight	8¼ in 210 mm



Yasargil Micro Bayonet Scissors

CODE	DESCRIPTION	LENGTH
59-1620	Straight	6½ in 165 mm
59-2033	Straight, Long Blades	8 in 201 mm
59-2320	Straight	8½ in 215 mm
59-2330	Straight, Vannas Blades	8½ in 215 mm
59-2031	Curved Up, Long Blades	8 in 200 mm
59-2034	Curved Up	8 in 200 mm
59-2336	Curved Up	9 in 230 mm
59-2321	Curved	9 in 230 mm
59-2331	Curved, Vannas Blades	9 in 230 mm

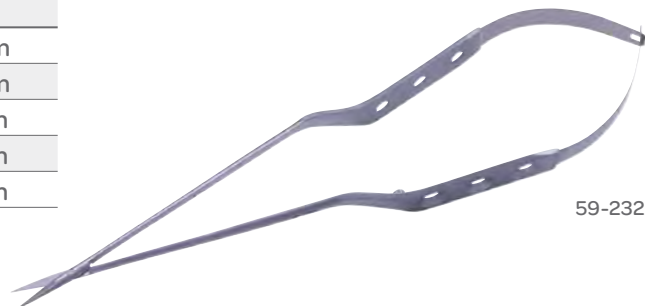

59-2320

Scissors (Micro Pituitary)

Micro Pituitary Style Scissors

Alligator Action, Semi-Malleable Shaft

CODE	DESCRIPTION	LENGTH
54-5607	Straight	7½ in 181 mm
54-5608	Curved Left	7½ in 181 mm
54-5609	Curved Right	7½ in 181 mm



Scissors (Micro)

Decker Microsurgical Scissors

Alligator Action

CODE	DESCRIPTION	LENGTH
54-5604	Straight	5½ in 140 mm
54-5605	Curved Left	5½ in 140 mm
54-5606	Curved Right	5½ in 140 mm



Scissors (Neurosurgical)

Malis® Neurosurgical Scissors

CODE	DESCRIPTION	LENGTH
54-1015	Curved	7 in 178 mm



Scissors (Neurosurgical)

Strully Neuro Scissors

CODE	DESCRIPTION	LENGTH
57-2520	Curved, Both Blades, Probe Tip	8 in 203 mm

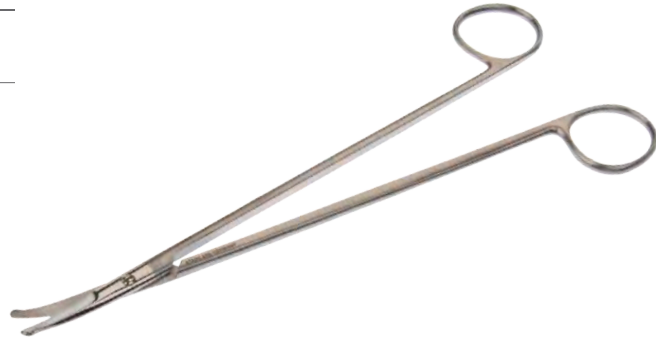

Scissors (Micro, Bayonet)

Spetzler Neurovascular Scissors

Titanium, Bayonet

CODE	DESCRIPTION	LENGTH
80-1907	Straight, 4 mm	9½ in 241 mm
80-1908	Curved, 4 mm, 30°	9½ in 241 mm



Scissors (Alligator)

Sweet Pituitary Scissors

Alligator Blades, Straight

CODE	BLADE LENGTH	LENGTH
54-1091	¾ in 10 mm	5½ in 140 mm



Scissors

Jacobson Scissors

CODE	DESCRIPTION	LENGTH
58-1524	Straight, Flat Bayonet Handle	7¼ in 184 mm
58-1525	Curved, Flat Bayonet Handle	7¼ in 184 mm



58-1522

Malis® Scissors

Titanium

CODE	DESCRIPTION	LENGTH
80-1520	Straight, Fine Tip	6¾ in 171 mm
80-1521	Straight, Curved Fine Tip	6¾ in 171 mm
80-1522	Straight, Bayonet, Regular Tip Working Distance 3¼ in (83 mm)	9½ in 241 mm
80-1523	Straight, Bayonet, Fine Tip Working Distance 3¼ in (83 mm)	9½ in 241 mm
80-1526	Curved Down, Bayonet, Regular Tip Working Distance 3¼ in (83 mm)	9½ in 241 mm
80-1524	Curved Up, Bayonet, Regular Tip Working Distance 3¼ in (83 mm)	9½ in 241 mm
80-1525	Curved Up, Bayonet, Fine Tip Working Distance 3¼ in (83 mm)	9½ in 241 mm



80-1520

Rhoton® Scissors

Titanium

CODE	DESCRIPTION	WORKING DISTANCE	LENGTH
80-1722	Straight Tip, Bayonet	3½ in 89 mm	8½ in 216 mm
80-1744	Straight Tip, Bayonet	3¾ in 95 mm	9½ in 241 mm
80-1723	Curved Tip, Bayonet	3½ in 89 mm	8½ in 216 mm
80-1745	Curved Tip, Bayonet	3¾ in 95 mm	9½ in 241 mm



80-1722

Scissors

Rhoton® Scissors

Titanium

CODE	DESCRIPTION	LENGTH
80-1720	Straight Tip	7 in 178 mm
80-1721	Curved Tip	7 in 178 mm



Scissors

Bayonet, Sharp/Sharp

CODE	DESCRIPTION	LENGTH
80-2073	Straight	4 in 100 mm
80-2074	Straight	4 in 100 mm
80-2072	Curved	4 in 100 mm

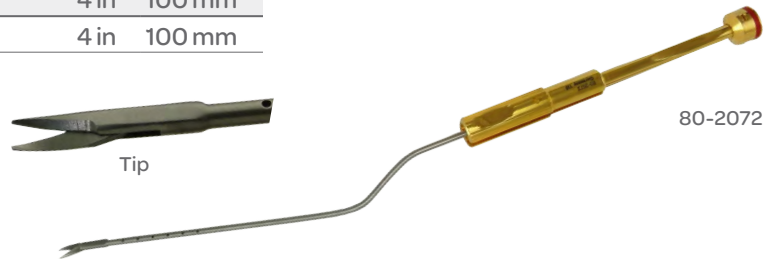

Scissors (Neurosurgical)

Dandy Trigeminal Scissors

CODE	DESCRIPTION	LENGTH
54-1041	Curved Sharp Tips, Angled Shaft	7 ¾ in 197 mm

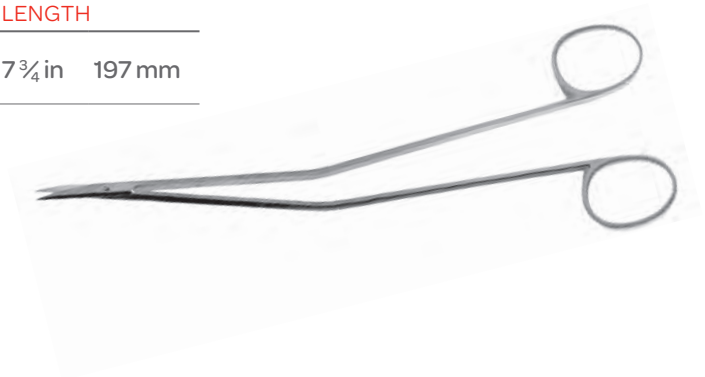

Scoops (Pituitary)

Fahlbusch Pituitary Scoop

CODE	DESCRIPTION	LENGTH
58-3626	Pituitary Scoop	10 ¼ in 260 mm



Separators (Dural)

Dorsey Dural Separator

CODE	BLADE (W X L)	LENGTH
65-1104	⅜ x 1 ⅛ in 5 x 26 mm	6 in 152 mm



Frazier Dural Separator

Tapered Blade Width, ⅛–⅜ in (2–3 mm)

CODE	BLADE DEPTH	LENGTH
65-1100	½ in 13 mm	6 ½ in 165 mm



Hoehn Dura Separator

CODE	DESCRIPTION	LENGTH
57-3501	45° Angle	6 in 152 mm



Hoehn Dural Separator

#1, 90° Angle

CODE	BLADE (W X L)	LENGTH
65-1101	⅛ x ½ in 3 x 13 mm	6 in 152 mm



Separators (Dural)

Horsley Dural Separator

CODE	DESCRIPTION	LENGTH
57-3510	40°	8 in 203 mm



Woodson Dural Separator & Spatula

CODE	DESCRIPTION	LENGTH
57-3516	4 mm Wide	10 in 254 mm



Separators (Packer)

Woodson Separator Packer

Double-Ended with Groove in Blade

CODE	BLADE (W X L)	LENGTH
65-1135	1/8 x 1/2 in 3 x 13 mm	7 in 178 mm



Skull Tongs

Gardner-Wells Traction Tongs

CODE	DESCRIPTION
57-6804	Skull Tongs, Maximum Opening 6 1/4 in (160 mm)
57-6804T	Skull tongs, Titanium Maximum Opening 6 1/4 in 160 mm
57-6806	Fix Screw, Spring-Loaded



57-6804

Skull Tongs

Raney-Crutchfield Skull Tongs

CODE	DESCRIPTION
57-6701	Skull Tongs
57-6702	Skull Tongs



57-6701

Skull Tong

CODE	DESCRIPTION
66-1025	Skull Tongs, Maximum Opening 6 ¼ in (160 mm) With One Spring-Loaded Point for Cervical Traction
66-1026	Adjustment Nut (Sold Each)
66-1027	S-Hook for Tongs
66-102	Test Bar



66-1025

Spatulas (Brain)

Cushing Brain Spatula

Double-Ended

CODE	WIDTH	LENGTH
57-3017	16 x 21 mm	6 ¾ in 171 mm
57-3020	21 x 26 mm	8 in 203 mm



57-3017

Cushing Brain Spatula-Spoon

CODE	CUP WIDTH	LENGTH
60-1010	½ in and ¾ in (13 mm and 19 mm)	6 ¾ in 171 mm



Spatulas (Brain)

Davis Brain Spatula

CODE	DESCRIPTION	LENGTH
22-0051	¼ in 6 mm	7 in 178 mm
22-0054	⅕ in 8 mm	7 in 178 mm
22-0060	½ in 13 mm	7 in 178 mm
22-0063	⅝ in 16 mm	7 in 178 mm
22-0073	1 in 25 mm	7 in 178 mm



Davis Brain Spatula

Double-Ended, Malleable, Stainless Steel

CODE	WIDTH	LENGTH
59-1080	¼ in 6 mm	7 in 178 mm
59-1081	⅜ in 10 mm	7 in 178 mm
59-1082	½ in 14 mm	7 in 178 mm
59-1083	⅝ in 16 mm	7 in 178 mm
59-1084	¾ in 19 mm	7 in 178 mm
59-1085	1 in 25 mm	7 in 178 mm
59-1086	1¼ in 32 mm	7 in 178 mm
59-1087	1½ in 38 mm	7 in 178 mm



Davis Insulated Brain Spatula

Malleable

CODE	DESCRIPTION	LENGTH
22-0051I	¼ in 6 mm	7 in 178 mm
22-0054I	⅕ in 8 mm	7 in 178 mm
22-0057I	⅜ in 10 mm	7 in 178 mm
22-0060I	½ in 12 mm	7 in 178 mm
22-0063I	⅝ in 16 mm	7 in 178 mm
22-0070I	⅞ in 22 mm	7 in 178 mm
22-0073I	1 in 25 mm	7 in 178 mm

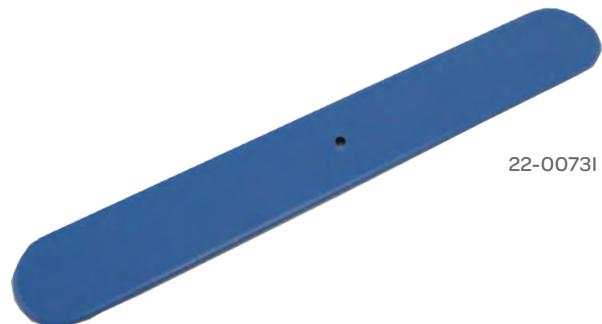

Spatulas (Brain)

Scoville Brain Spatula

Double-Ended, Malleable

CODE	BLADE WIDTHS	LENGTH
59-1070	$\frac{3}{8}$ and $\frac{1}{2}$ in	10 and 13 mm 7 in 178 mm
59-1071	$\frac{5}{8}$ and $\frac{3}{4}$ in	16 and 19 mm 7 in 178 mm



59-1071

Silicone Brain Spatula

CODE	DESCRIPTION	LENGTH
57-0002S	Set of 4 One of Each Size Below.	
57-0001	6.0 mm	$6\frac{7}{8}$ in 175 mm
57-0002	9.0 mm	$6\frac{7}{8}$ in 175 mm
57-0003	11 mm	$6\frac{7}{8}$ in 175 mm
57-0004	13 mm	$6\frac{7}{8}$ in 175 mm



57-0002S

Spatulas (Nerve)

Davis Nerve Separator/Spatula

CODE	DESCRIPTION	LENGTH
57-3519	Semi-Sharp	$7\frac{1}{2}$ in 191 mm



Speculums (Transsphenoidal)

Hardy™ Nasal Bivalve Specula

Black Anodized Finish, Except Knob

CODE	DESCRIPTION	LENGTH
80-1350	Small	$2\frac{3}{4}$ in 70 mm
80-1352	Standard	$3\frac{1}{8}$ in 79 mm
80-1351	Acromegalic	$3\frac{1}{2}$ in 89 mm



80-1350

Sponges (Tonsil)

Secto® Tonsil Sponges

Sterile, 5 Per Card/Pouch, 25 Pouches Per Dispenser, 2 Dispenser Boxes Per Case.

CODE	DESCRIPTION	LENGTH
81-1010	X-Ray Detectable	$\frac{5}{8}$ in 16 mm
81-1011	X-Ray Detectable	1 in 25 mm
81-1012	X-Ray Detectable	$1\frac{1}{4}$ in 32 mm



81-1012

Spoons (Pituitary)

Cushing Pituitary Spoon

Malleable Copper, Silver Plated

CODE	NO.	CUP WIDTH	CUP LENGTH	LENGTH
60-1000	1	$\frac{1}{4}$ in 6 mm	$\frac{3}{8}$ in 10 mm	$9\frac{1}{4}$ in 235 mm
60-1001	2	$\frac{5}{16}$ in 8 mm	$\frac{1}{2}$ in 13 mm	$9\frac{1}{4}$ in 235 mm
60-1002	3	$\frac{5}{16}$ in 8 mm	$\frac{5}{8}$ in 16 mm	$9\frac{1}{4}$ in 235 mm
60-1003	4	$\frac{3}{8}$ in 10 mm	$\frac{5}{8}$ in 16 mm	$9\frac{1}{4}$ in 235 mm

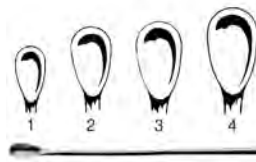

60-1000

Spoons (Transsphenoidal)

Hardy™ Pituitary Spoon

Bayonet, Malleable

CODE	WORKING DISTANCE	LENGTH
80-1336	$4\frac{3}{4}$ in 121 mm	$9\frac{1}{4}$ in 235 mm

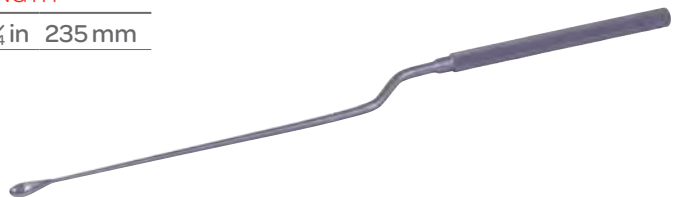

Kits



80-1820

Microvascular STA-MCA Kit

The Microvascular Kit is a coordinated instrument approach to the STA-MCA (Superficial Temporal Anastomosis to the Middle Cerebral Anastomosis). The Microvascular set of instruments includes eight titanium microvascular instruments and two stainless steel specially modified alm wound retractors, all in a Microcare stainless steel instrument case.

CODE	DESCRIPTION	LENGTH	
80-1820	Kit Includes Items Below:	7 in	178 mm
80-1800	Needle Holder, Curved, Two Each		
80-1803	Scissors, 60° Angled, Straight Tip		
80-1804	Scissors, 60° Angled, Curved Tip, Right		
80-1805	Scissors, 60° Angled, Curved Tip, Left		
80-1802	Scissors, Curved		
80-1801	Scissors, Straight		
80-1807	Microvascular Tying Forceps, Curved, Titanium, Tip Width 0.7 mm	7 in	178 mm
80-1806	Microvascular Tying Forceps, Straight, Titanium, Tip Width 0.6 mm	7 in	178 mm
80-1812	Microvascular Modified Alm Retractors, Black Anodized, 4 x 4 Prongs	3 in	76 mm
80-1813	Microvascular Modified Alm Retractors, Black Anodized, 12 x 12 Prongs	3¾ in	95 mm
80-1818	Microcare Instrument Case		

Kits (Micro Instrument)

Symmetry Micro Instrument Kit

	CODE	DESCRIPTION	TIP	LENGTH	COLOR	
	801003	Complete Set includes 1 each of all products listed below.				
NEEDLE HOLDERS	80-2069	Bayonet, Straight	1x6 mm	4 in	100 mm	Yellow
	80-2070	Bayonet, Curved	1x6 mm	4 in	100 mm	Yellow
	80-2071	Bayonet, Straight, Blunt		4 in	100 mm	Red
SCISSORS HOLDERS	80-2072	Bayonet, Curved, Sharp		4 in	100 mm	Red
	80-2073	Bayonet, Straight, Sharp		4 in	100 mm	Red
	80-2074	Bayonet, Horizontal, Sharp		4 in	100 mm	Red
FORCEPS	80-2066	Bayonet, Smooth	0.5 mm	4 in	100 mm	Green
	80-2067	Bayonet, Serrated	3.0 mm	4 in	100 mm	Green
	80-2068	Bayonet, Curved Left	0.75 mm	14 in	100 mm	Green
CUP FORCEPS	80-2060	Bayonet, Vertical	2.0 mm	4 in	100 mm	Blue
	80-2061	Bayonet, Vertical	4.0 mm	4 in	100 mm	Blue
	80-2062	Bayonet, Vertical	6.0 mm	4 in	100 mm	Blue
	80-2063	Bayonet, Horizontal	2.0 mm	4 in	100 mm	Blue
	80-2064	Bayonet, Horizontal	4.0 mm	4 in	100 mm	Blue
DISSECTORS	80-2065	Bayonet, Horizontal	6.0 mm	4 in	100 mm	Blue
	20-2081	Straight	1.2 mm	8 ¹¹ / ₃₂ in	200 mm	
	20-2082	Straight	1.5 mm	8 ¹¹ / ₃₂ in	200 mm	
	20-2083	Straight	2.0 mm	8 ¹¹ / ₃₂ in	200 mm	
	20-2084	Straight	1.2 mm	10 in	260 mm	
	20-2085	Straight	1.5 mm	10 in	260 mm	
DISC DISSECTOR	20-2086	Straight	2.0 mm	10 in	260 mm	
	80-2078	Straight, Round	2.5 mm	8 ¹¹ / ₃₂ in	200 mm	
TUMOR KNIVES	80-2075	Straight, Round	1.0 mm	8 ¹¹ / ₃₂ in	200 mm	
	80-2075	Straight, Round	3.0 mm	8 ¹¹ / ₃₂ in	200 mm	
	80-2077	Straight, Round	5.0 mm	8 ¹¹ / ₃₂ in	200 mm	
MICRO HOOKS	20-8079	Straight, Sharp, 45°		8 ¹¹ / ₃₂ in	200 mm	
	20-8079	Straight, Blunt, 45°		8 ¹¹ / ₃₂ in	200 mm	
SUCTION	67-7862	Fukushima, Malleable, Teardrop, 4 French				
	67-7862	Fukushima, Malleable, Teardrop, 5 French				
	67-7862	Fukushima, Malleable, Teardrop, 6 French				
	67-7862	Fukushima, Malleable, Teardrop, 7 French				
	67-7862	Fukushima, Malleable, Teardrop, 8 French				
	67-7862	Fukushima, Malleable, Teardrop, 9 French				

Suction (Tubes)

Malis®-Frazier Suction Tube

CODE	DESCRIPTION	LENGTH
70-1104	7 French, Black Anodized	7½ in 191 mm



Yasargil Micro Suction Tube

CODE	DESCRIPTION	LENGTH
80-1621	Medium, O.D. 2.5 mm	14 in 356 mm
80-1622	Large, O.D. 3.5 mm	14 in 356 mm

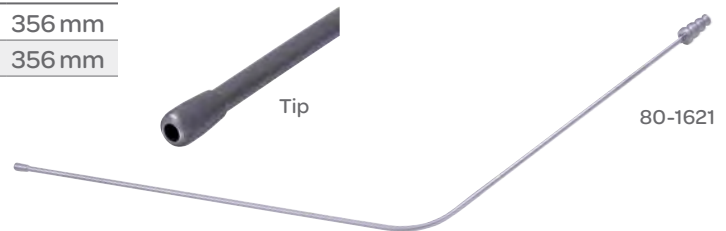

Rhoton® Neuro Suction Tube

CODE	DESCRIPTION	LENGTH
58-6303	3 French, Straight Tip	3¼ in 83 mm
58-6305	5 French, Straight Tip	3¼ in 83 mm
58-6307	7 French, Straight Tip	3¼ in 83 mm
58-6310	10 French, Straight Tip	3¼ in 83 mm
58-6311	12 French, Straight Tip	3¼ in 83 mm
58-6313	3 French, Straight Tip	4 in 102 mm
58-6315	5 French, Straight Tip	4 in 102 mm
58-6317	7 French, Straight Tip	4 in 102 mm
58-6320	10 French, Straight Tip	4 in 102 mm
58-6322	12 French, Straight Tip	4 in 102 mm
58-6335	5 French, Angled Tube	5¼ in 133 mm
58-6337	7 French, Angled Tube	5¼ in 133 mm
58-6340	10 French, Angled Tube	5¼ in 133 mm
58-6327	7 French, Straight Tip	5½ in 140 mm
58-6330	10 French, Straight Tip	5½ in 140 mm
58-6331	12 French, Straight Tip	5½ in 140 mm

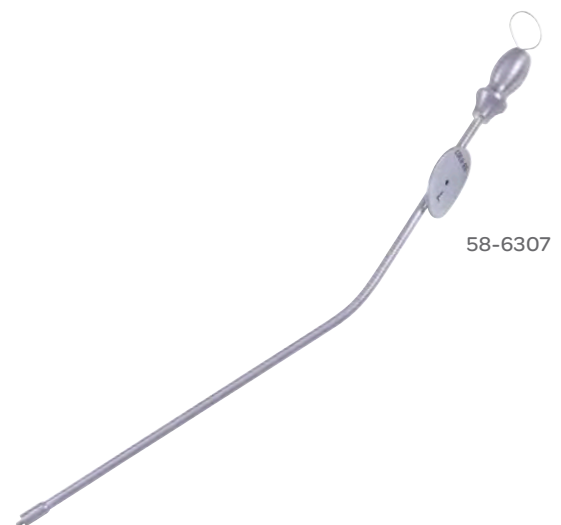

Suction (Tubes)

Wire Stylet

CODE	DESCRIPTION
46-4000	Used With Dural Suction Retractors for Cleaning and Storage

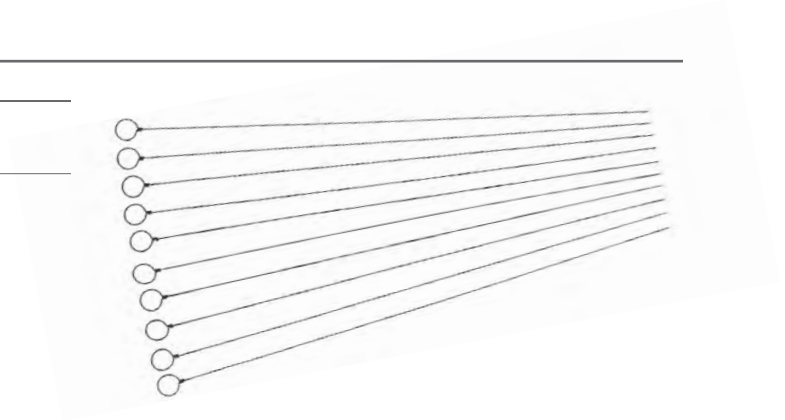

Fukushima Tapered Teardrop Suction Tube

Malleable Tube

CODE	DESCRIPTION	LENGTH
67-7850	4 French	6¼ in 159 mm
67-7851	5 French	6¼ in 159 mm
67-7852	6 French	6¼ in 159 mm
67-7853	7 French	6¼ in 159 mm
67-7854	8 French	6¼ in 159 mm
67-7855	9 French	6¼ in 159 mm
67-7856	4 French	7 in 178 mm
67-7857	5 French	7 in 178 mm
67-7858	6 French	7 in 178 mm
67-7859	7 French	7 in 178 mm
67-7860	8 French	7 in 178 mm
67-7861	9 French	7 in 178 mm
67-7862	4 French	8 in 203 mm
67-7863	5 French	8 in 203 mm
67-7864	6 French	8 in 203 mm
67-7865	7 French	8 in 203 mm
67-7866	8 French	8 in 203 mm
67-7867	9 French	8 in 203 mm
67-7868	4 French	9 in 229 mm
67-7869	5 French	9 in 229 mm
67-7870	6 French	9 in 229 mm
67-7871	7 French	9 in 229 mm
67-7872	8 French	9 in 229 mm
67-7873	9 French	9 in 229 mm



Suction (Tubes)

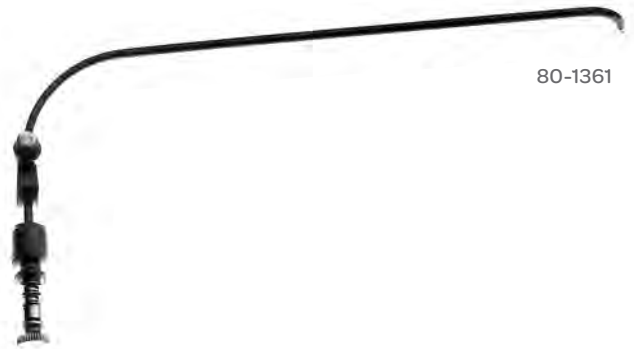

80-1361

Hardy™ Suction Tube

Angular with Thumb Control, Insulated

CODE	DESCRIPTION	LENGTH
80-1361	7 French, Curved Right	7¼ in 184 mm
80-1360	7 French, Curved Left	7¼ in 184 mm



70-1146

Adson Suction Tube

Curved Tip with Thumb Piece to Control Suction

CODE	DESCRIPTION	LENGTH
70-1146	12 French	5½ in 140 mm
70-1148	15 French	7½ in 191 mm

Suction (Tubes)

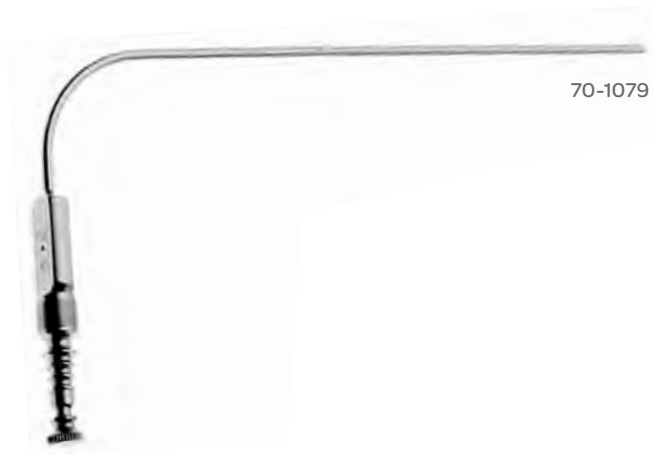

70-1079

Frazier Suction Tube

CODE	DESCRIPTION	TUBING LENGTH
70-1079	Angular, With Thumb Control, 7 French	4 ½ in 114 mm
70-1005	Angular, With Thumb Control, Insulated, 7 French	4 ½ in 114 mm
70-1080	Angular, With Thumb Control, 9 French	4 ½ in 114 mm
70-1006	Angular, With Thumb Control, Insulated, 9 French	4 ½ in 114 mm
70-1081	Angular, With Thumb Control, 11 French	4 ½ in 114 mm
70-1007	Angular, With Thumb Control, Insulated, 11 French	4 ½ in 114 mm
70-1100	Straight, With Thumb Control, 7 French	5 ¼ in 133 mm
70-1101	Straight, 9 French, With Thumb Control,	5 ¼ in 133 mm
70-1102	Straight, 11 French, With Thumb Control,	5 ¼ in 133 mm
70-1087	Angular, With Thumb Control, 7 French	7 ½ in 191 mm
70-1088	Angular, With Thumb Control, 9 French	7 ½ in 191 mm
70-1089	Angular, With Thumb Control, 11 French	7 ½ in 191 mm
70-1015	Angular, With Thumb Control, Insulated, 7 French	7 ½ in 191 mm
70-1016	Angular, With Thumb Control, Insulated, 9 French	7 ½ in 191 mm
70-1017	Angular, With Thumb Control, Insulated, 11 French	7 ½ in 191 mm



Malis®-Frazier Suction Tube

CODE	DESCRIPTION	TUBING LENGTH
70-1103	Black Anodized, 7 French	4 ¼ in 108 mm

Suction (Tubes)

Pribram Suction Tube

16 Gauge, With Thumb Control

CODE	TUBING LENGTH	LENGTH
70-1128	5½ in	5½ in 140 mm
70-1130	5½ in	5½ in 140 mm



Rhoton®-Merz Suction Tube

50° Angle

CODE	DESCRIPTION	LENGTH
32-3721	7 French	4 in 100 mm
32-3722	10 French	4 in 100 mm



Sachs Suction Tube

50° Angle

CODE	DESCRIPTION	SHAFT LENGTH
70-1160	Small, 8 French x 4 in (102 mm)	9⅝ in 244 mm
70-1161	Large, 15 French x 4½ in (114 mm)	9⅝ in 244 mm



Test Instruments (Neurological)

Millet Neurological Test Instrument

24-1010 Millet Neurological Test Instrument, incorporating a C-128 tuning fork.

CODE	DESCRIPTION	LENGTH
24-1010	Instrument Includes One Each of the Following:	8 1/8 in 206 mm
	MILLET Pinwheel	
	MILLET Rubber Percussor, Large	
	MILLET Rubber Percussor, Small	
	MILLET Cap for large Percussor	
	MILLET Brush Assembly	
	MILLET Needle	



Transsphenoidal Instruments (Hardy™)

Hardy™ Curette

Bayonet, Working Distance 4 3/4 in (121 mm)

CODE	DESCRIPTION	TIP WIDTH	LENGTH
80-1347	45° Right	3 mm	9 1/4 in 235 mm
80-1334	45° Right	5 mm	9 1/4 in 235 mm
80-1348	90° Left	3 mm	9 1/4 in 235 mm
80-1333	90° Left	5 mm	9 1/4 in 235 mm
80-1345	Angled Down	3 mm	9 1/4 in 235 mm
80-1330	Angled Down	5 mm	9 1/4 in 235 mm
80-1346	Angled Up	3 mm	9 1/4 in 235 mm
80-1331	Angled Up	5 mm	9 1/4 in 235 mm
80-1335	Curved Left	3 mm	9 1/4 in 235 mm
80-1332	Curved Right	5 mm	9 1/4 in 235 mm

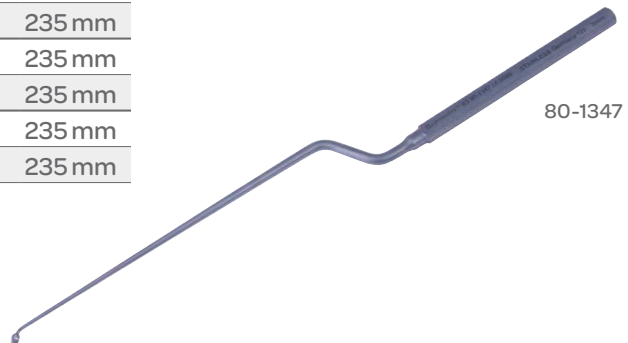

Transsphenoidal Instruments (Hardy™)

Hardy™ Dressing Forceps

Bayonet, Working Distance 4 ½ in (114 mm)

CODE	TIP WIDTH	LENGTH
30-1205	1 mm	8 ¼ in 210 mm

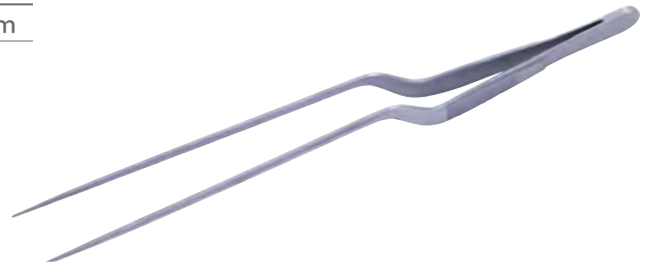

Hardy™ Eucleator

CODE	DESCRIPTION	LENGTH
80-1328	Bayonet, Three Prong Working Distance 3 ½ in (89 mm)	8 ⅛ in 205 mm
80-1311	Left, Micro, 2.4 mm	9 ¼ in 235 mm
80-1325	Left, 2.6 mm	9 ¼ in 235 mm
80-1312	Right, Micro, 2.4 mm	9 ¼ in 235 mm
80-1326	Right, 2.6 mm	9 ¼ in 235 mm
80-1329	Reverse Curve, 2.6 mm	9 ¼ in 235 mm

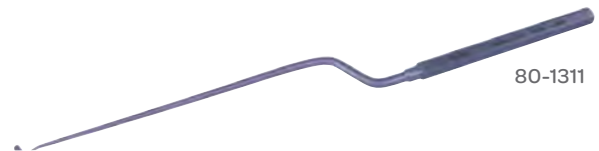

Hardy™ Instrument Case With Removable Panels

For Hardy™ Brand Transsphenoidal Instruments

CODE	DESCRIPTION	LENGTH
80-1355	Width 7 in (178 mm) Depth 2 ¼ in (57 mm)	11 in 279 mm



Transsphenoidal Instruments (Hardy™)

Hardy™ Knife Handle

Working Distance 3 ½ in (89 mm)

CODE	DESCRIPTION	LENGTH
80-1314	Lateral, Bayonet	8 ¼ in 205 mm
80-1313	Vertical, Bayonet	8 ¼ in 205 mm



80-1314

Hardy™ Lip Retractor

CODE	DESCRIPTION
80-1337	Lip Retractor



Hardy™ Micro Dissector

Working Distance 4 ¾ in (121 mm)

CODE	DESCRIPTION	LENGTH
80-1316	Angled Down, Bayonet	9 ¼ in 235 mm
80-1315	Angled Up, Bayonet	9 ¼ in 235 mm

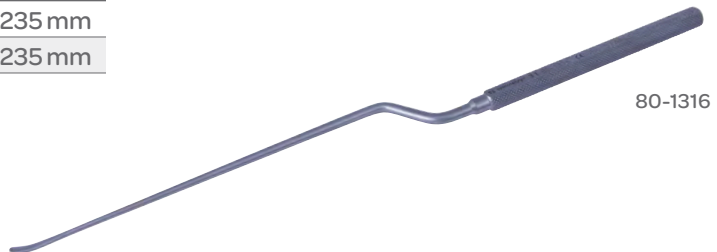

80-1316

Transsphenoidal Instruments (Hardy™)

Hardy™ Nasal Bivalve Specula

Black Anodized Finish, Except Knob

CODE	DESCRIPTION	LENGTH
80-1350	Small	2 ¾ in 70 mm
80-1352	Standard	3 ⅛ in 79 mm
80-1351	Acromegalic	3 ½ in 89 mm



80-1350

Hardy™ Pituitary Spoon

Working Distance 4 ¾ in (121 mm)

CODE	DESCRIPTION	LENGTH
80-1336	Bayonet, Malleable	9 ¼ in 235 mm



Trephines

Galt Trephine

CODE	DESCRIPTION	LENGTH
57-6313	Trephine	½ in 13 mm



Michele Trephine

Shaft Graduated

CODE	DESCRIPTION	LENGTH
57-6305	¼-1 ¼ in, 5 mm	6 ¼ in 159 mm





Scan the code above to learn more about our Obese Patient Solutions portfolio.

Obese Patient Solutions Portfolio

Symmetry Surgical has a broad portfolio of surgical instruments designed specifically for large or obese patients. Our extended-length instruments span all specialties and give surgeons additional reach to aid in completion of procedures.



symmetry surgical™

Obese Patient Solutions



Aspirators	OBE-2	Needle Holders	OBE-38
Chisels	OBE-2	Osteotomes	OBE-41
Clamps	OBE-3	Pliers	OBE-42
Containers	OBE-8	Probes	OBE-42
Curettes	OBE-9	Retractors	OBE-43
Dissectors	OBE-19	Rongeurs	OBE-67
Elevators	OBE-20	Scissors	OBE-71
Forceps	OBE-23	Shears	OBE-77
Gouges	OBE-34	Spatulas	OBE-78
Hooks	OBE-34	Spreaders	OBE-79
Knife Handles	OBE-36	Suction Tubes	OBE-79
Laparoscopic	OBE-37		

Questions? Contact us at customerservice@symmetrysurgical.com or learn more at symmetrysurgical.com



The Surgical Instrument Desk Reference

How to Use Our Catalog

The Symmetry Surgical catalog is designed with you in mind, to be your trusted resource for surgical instrumentation. We took great care in creating an easy-to-use, robust catalog and we think you'll be pleased with the design as you become more familiar with our broad portfolio.

Layout

The catalog is organized by surgical specialty *and* product function.

And we know that it is difficult to pick up an instrument and know what specialty it's listed in. To make your job easier, we've sorted the instruments in our portfolio by surgical function, too, including Energy, Laparoscopic, Retractors and Sterilization Solutions.

U.S. Customer Service

Your Symmetry Surgical Customer Service team wants to make ordering surgical instruments the easiest part of your day. We accept orders via phone, fax, email, our website, Global Healthcare Exchange (GHX) and through the mail.

PHONE

1.800.251.3000

(Available Monday through Friday, 8:30 AM–6:30 PM EST)

FAX

1.800.342.3272

EMAIL

customerservice@symmetrysurgical.com

ONLINE

symmetrysurgical.com

MAILING ADDRESS

Symmetry Surgical
Attn: Customer Service
3034 Owen Drive
Antioch, TN 37013

The Surgical Instrument Desk Reference

International Customer Service

PHONE

Symmetry Surgical Switzerland GmbH
+41 (0) 52 557 59 00
(Available Monday through Friday, 7:00-16:00 GMT)

Symmetry Surgical, Inc., USA
1.615.964.5672
(Available Monday through Friday, 8:30 AM–6:30 PM EST)

FAX

Symmetry Surgical Switzerland GmbH
+41 (0) 52 557 59 99

EMAIL

customerservice@symmetrysurgical.com
internationalorders@symmetrysurgical.com

ONLINE

symmetrysurgical.com

MAILING ADDRESS

Symmetry Surgical Switzerland GmbH
Bühlstrasse 27
CH-8200 Schaffhausen
Switzerland

Symmetry Surgical, Inc.
3034 Owen Drive
Antioch, TN 37013

INTERNATIONAL PAYMENT TERMS/RETURN GOODS POLICY/INSTRUMENT REPAIR & RESTORE PROGRAM/LITERATURE REQUESTS

Please contact your local distributor. Locate a local distributor contact, International Customer Service at +41 (0) 52 557 59 00 or 1.615.964.5672 (US).

Cardiovascular/Thoracic

Energy

Ear, Nose & Throat

General

Laparoscopic

Neurology

Obesity

OB/GYN

Ophthalmology

Orthopedics & Arthroscopy

Pediatrics

Rectal

Retractors

Spine

Urology

Sterilization Solutions

Alphabetical & Numeric Indexes

Aspirators (Needle)

Needle Aspirator

CODE	DESCRIPTION	LENGTH
90-5051L	15 Gauge	17 ³ / ₄ in 450 mm
90-5052L	22 Gauge	17 ³ / ₄ in 450 mm

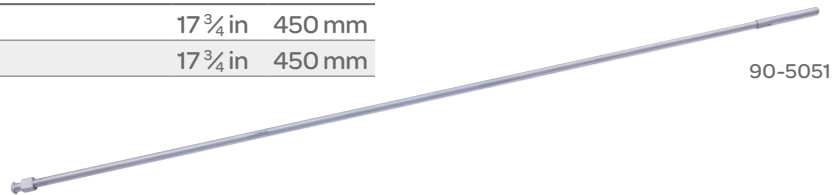

90-5051

Chisels

Chisel

CODE	DESCRIPTION	TIP WIDTH	LENGTH
67-7018	Straight Stiletto	³ / ₄ in 20 mm	9 ¹ / ₂ in 241 mm

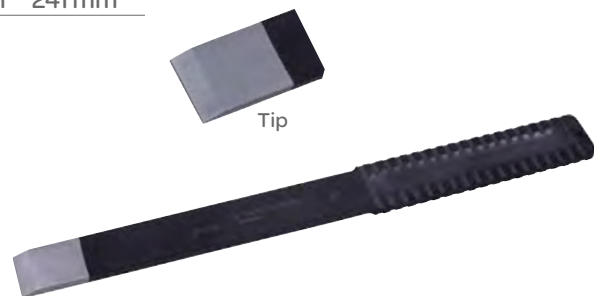

Tip

Puka Chisel

CODE	DESCRIPTION	TIP WIDTH	LENGTH
67-7003	#2	³ / ₈ in 10 mm	11 in 279 mm



Chisels (Spinal)

Spinal Fusion Chisel

CODE	DESCRIPTION	TIP WIDTH	BLADE WIDTH	LENGTH
18-1011	Straight	6 mm	¹⁵ / ₆₄ in	9 ¹ / ₂ in 241 mm
67-7001	Straight	6 mm	¹⁵ / ₆₄ in	10 ¹ / ₂ in 267 mm



67-7001

Clamps (Anastomosis)

Clamp Cooley Classic® Anastomosis Clamp

Serration Markings, 2.5 mm, 2x2 Teeth

CODE	DESCRIPTION	LENGTH
67-7567	Small Jaw	12 in 305 mm
677564	Medium Jaw	12 in 305 mm



67756

Clamps (Aorta)

Ochsner Aorta Clamp

1x2 Vascular Teeth

CODE	JAW LENGTH	JAW DEPTH	LENGTH
37-1026	2 1/8 in 55 mm	3/4 in 18 mm	10 3/8 in 264 mm

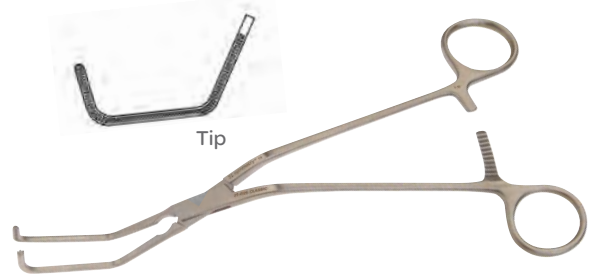

Clamps (Aortic Aneurysm)

DeBakey Aortic Aneurysm Clamp

1x2 Vascular Teeth

CODE	JAW LENGTH	LENGTH
37-1141	3 3/8 in	10 1/2 in 267 mm
37-1142	4 in	12 in 305 mm
37-1143	4 3/4 in	12 1/2 in 318 mm

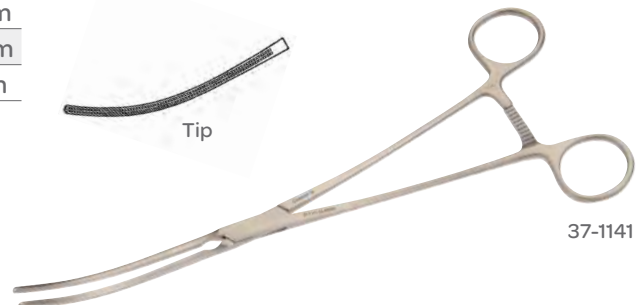

37-1141

Clamps (Bronchus)

Lees Bronchus Clamp

1 x 2 Vascular Teeth

CODE	JAW LENGTH	LENGTH
37-1035	1 $\frac{5}{8}$ in 41 mm	9 $\frac{1}{2}$ in 241 mm

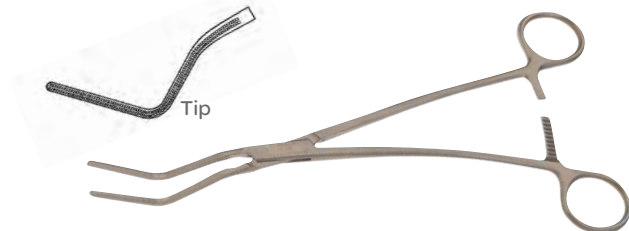

Clamps (Coarctation)

Crafoord Coarctation Clamp

Curved Jaw

CODE	JAW LENGTH	LENGTH
19-8104	2 $\frac{1}{2}$ in 241 mm	9 $\frac{1}{2}$ in 241 mm
677521	4 x 67 mm	10 $\frac{1}{2}$ in 267 mm
677522	4 x 67 mm	12 in 305 mm



19-8104

Glover Opti-Length® Coarctation Clamp

CODE	DESCRIPTION	LENGTH
67-7525	Straight	10 in 254 mm
67-7526	Curved	10 in 254 mm



67-7526

Clamps (Hemostatic)

Gemini Hemostatic Clamp

CODE	DESCRIPTION	LENGTH
19-5582	Curved	9 in 229 mm
19-5583	Curved	10 in 279 mm

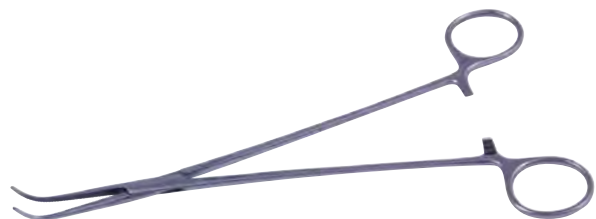

18-5582

Clamps (Iliac)

Cooley Opti-Length® Iliac Clamp

2x2 Vascular Teeth

CODE	DESCRIPTION	LENGTH
67-7533	Angled	12 in 305 mm

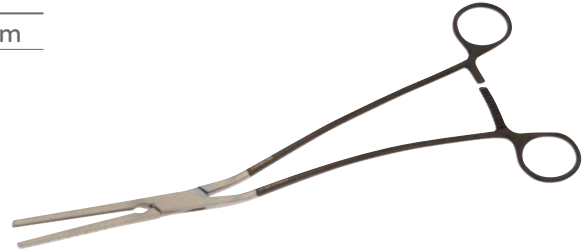

Clamps (Intestinal)

Dennis Intestinal Clamp

CODE	JAW LENGTH	LENGTH
19-4060	2¼ in 57 mm	9½ in 241 mm

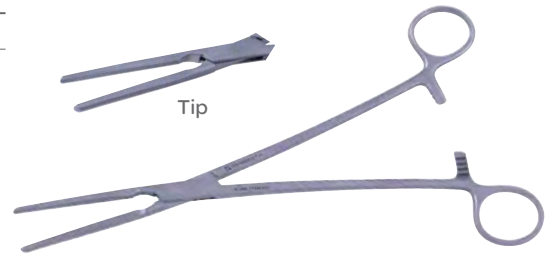

Glassman Gastrointestinal Clamp

3 mm Tip, Clamp Non Crushing

CODE	DESCRIPTION	LENGTH
67-7528	Straight	10 in 254 mm
67-7530	Straight	11¼ in 286 mm
67-7532	Straight	13 in 330 mm
67-7527	Angled	10 in 254 mm
67-7529	Angled	11¼ in 286 mm
67-7531	Angled	13 in 330 mm



Masters Intestinal Clamp

CODE	JAW LENGTH	LENGTH
19-4062	4½ in 114 mm	9¼ in 235 mm
19-4061	6½ in 165 mm	10¾ in 273 mm



19-4062

Clamps (Ligature Carrying)

Classic® Opti-Length® Ligature Carrying Clamp

CODE	LENGTH
67-7534	11 in 279 mm
67-7535	12 in 305 mm



67-7534

Clamps (Liver)

Masters-Schwartz Liver Clamp

CODE	JAW LENGTH	JAW WIDTH	LENGTH
19-4063	7½ in 191 mm	½ in 13 mm	12 in 305 mm



Clamps (Pelvic)

Masterson Pelvic Clamp

Jaw Length 1¾ in (45 mm), 2 x 3 Vascular Teeth

CODE	DESCRIPTION	LENGTH
37-1522	Straight	10½ in 267 mm
37-1523	Curved	10½ in 267 mm

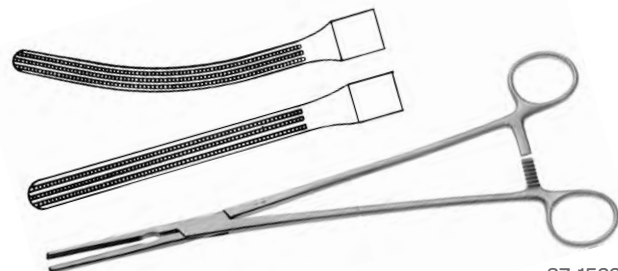

37-1522

Harrington-Mixer Clamp

Longitudinal Serrations with Cross-Serrated Tips

CODE	DESCRIPTION	LENGTH
30-8051	Right Angle	12¼ in 311 mm



Clamps (Thoracic)

Harrington Thoracic Clamp

CODE	DESCRIPTION	LENGTH
30-8049	Right Angled	12 in 305 mm

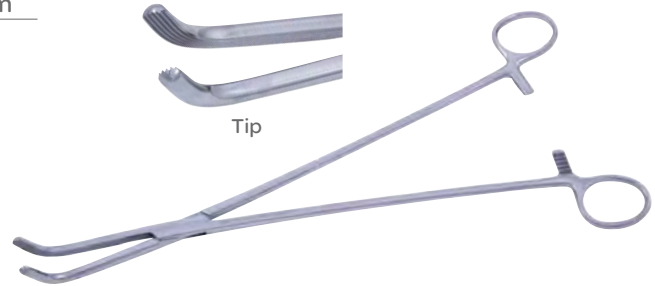

Jones Thoracic Clamp

CODE	DESCRIPTION	LENGTH
19-8152	Curved	11¼ in 286 mm

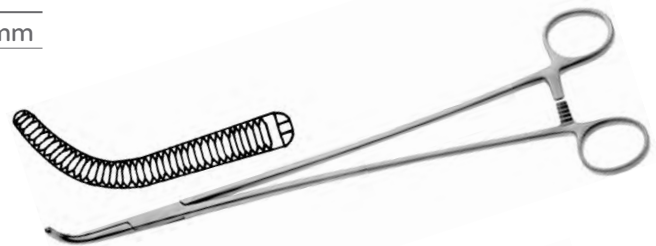

Mixer Thoracic Clamp

Angular

CODE	DESCRIPTION	LENGTH
19-8146	Longitudinal Serrations	11 in 279 mm
19-8147	Standard Jaw	11 in 279 mm

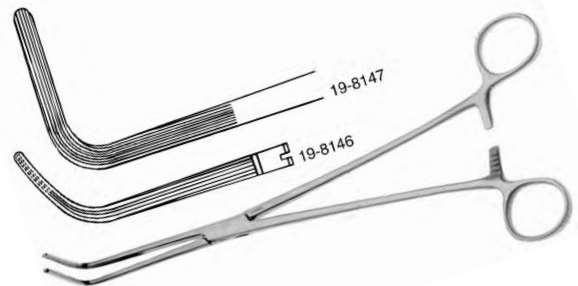

Modified Collier Thoracic Clamp

CODE	DESCRIPTION	LENGTH
30-8065	Curved	10½ in 267 mm

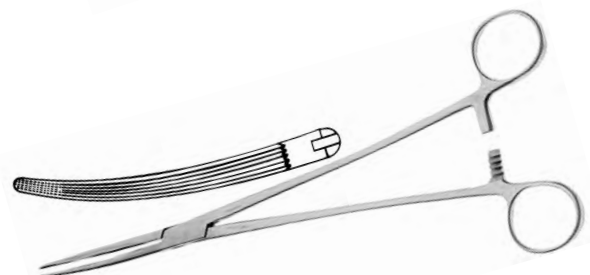

Clamps (Vascular)

DeBakey Classic® Vascular Clamp

CODE	LENGTH
67-7523	9 in 229 mm
67-7524	10 in 254 mm

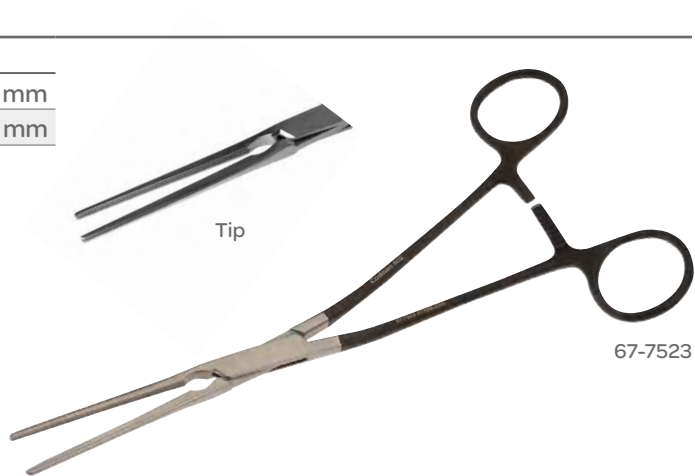

DeBakey Vascular Clamp

Acutely Curved

CODE	VASCULAR TEETH	JAW LENGTH	JAW DEPTH	LENGTH
37-1130	1x2	2 in	3/8 in	9 1/2 in 241 mm



Containers (Sterilization Case)

Karlin™ PG Magnum Case

CODE	DESCRIPTION
46-3407	Storage/Sterilizing Case for 12 Magnum Handle Instruments



Containers (Sterilization Case)

Karlin™ XL Magnum Case

CODE	DESCRIPTION
46-3222	Storage/Sterilizing Case for 12 'XL Magnum' Instruments



OBESE PATIENT

Curettes

Cobb Curette

CODE	DESCRIPTION	TIP SIZE	LENGTH
23-2570	#000	3 mm	11 in 279 mm
23-2571	#00	4 mm	11 in 279 mm
23-2572	#0	5 mm	11 in 279 mm
23-2573	#1	6 mm	11 in 279 mm
23-2574	#2	8 mm	11 in 279 mm
23-2576	#4	12 mm	11 in 279 mm
23-2577	#5	13 mm	11 in 279 mm
23-2578	#6	15 mm	11 in 279 mm

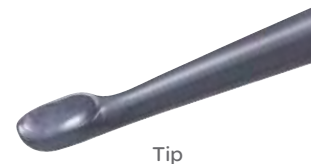

Curettes

Cobb Spinal Curette

CODE	CUP	LENGTH
677104	2 x 3.3 mm	12 ½ in 318 mm
677107	2.5 x 4 mm	12 ½ in 318 mm
677109	3 x 5 mm	12 ½ in 318 mm
677111	3.5 x 6 mm	12 ½ in 318 mm
677113	4.5 x 7.5 mm	12 ½ in 318 mm
677115	5.5 x 9 mm	12 ½ in 318 mm
677117	7.5 x 11.5 mm	12 ½ in 318 mm
677119	8.5 x 13 mm	12 ½ in 318 mm
677121	10 x 15.5 mm	12 ½ in 318 mm
677106	2 x 3.3 mm	14 in 356 mm
677108	2.5 x 4 mm	14 in 356 mm
677110	3 x 5 mm	14 in 356 mm
677112	3.5 x 6 mm	14 in 356 mm
677114	4.5 x 7.5 mm	14 in 356 mm
677116	5.5 x 9 mm	14 in 356 mm
677118	7.5 x 11.5 mm	14 in 356 mm
677120	8.5 x 13 mm	14 in 356 mm
677122	10 x 15.5 mm	14 in 356 mm
677105	2 x 3.3 mm	15 in 381 mm



677104

Scoville Curette

4 x 10 mm Cup

CODE	DESCRIPTION	LENGTH
23-1000	Straight	10 in 254 mm
23-1002	Angular	10 in 254 mm
23-1001	Lateral	10 in 254 mm



23-1000

Curettes

Spinal Fusion Curette

Straight

CODE	DESCRIPTION	CUP	LENGTH
677186	#000	3.5 x 5 mm	13 in 330 mm
677187	#00	4 x 5.5 mm	13 in 330 mm
677188	#0	4.5 x 6.5 mm	13 in 330 mm
677189	#1	5 x 7.5 mm	13 in 330 mm
677190	#2	6 x 10 mm	13 in 330 mm
677191	#3	7 x 11 mm	13 in 330 mm
677192	#4	8.5 x 13 mm	13 in 330 mm
677193	#5	9.5 x 14.5 mm	13 in 330 mm
677194	#6	10.5 x 17 mm	13 in 330 mm



677194

Spinal Fusion Curette

Straight

CODE	DESCRIPTION	CUP	LENGTH
677209	#000	3.5 x 5 mm	15 in 381 mm
677211	#00	4.5 x 6.5 mm	15 in 381 mm
677212	#0	5 x 7.5 mm	15 in 381 mm
677221	#1	6 x 10 mm	15 in 381 mm
677213	#2	7 x 11 mm	15 in 381 mm
677214	#3	8.5 x 13 mm	15 in 381 mm
677215	#4	9.5 x 14.5 mm	15 in 381 mm
677216	#5	10.5 x 17 mm	15 in 381 mm



Tip

677211

Scoville Spinal Disc Curette

CODE	DESCRIPTION	CUP	LENGTH
67-7171	Straight	4 x 10 mm	12 in 305 mm
67-7172	Straight	4 x 10 mm	14 in 356 mm
67-7173	Straight	6 x 10 mm	15 in 381 mm
67-7177	Angular Cup	4 mm	12 in 305 mm
67-7178	Angular Cup	4 mm	14 in 356 mm
67-7179	Angular Cup	6 mm	15 in 381 mm
67-7174	Down Pushing	4 mm	12 in 305 mm
67-7175	Down Pushing	4 mm	14 in 356 mm
67-7176	Down Pushing	6 mm	15 in 381 mm



677171

Curettes

Karlin™ Lumbar Microdiscectomy Instruments

Offset, Black Handles, Tip Configuration Marked On Handle

CODE	DESCRIPTION	LENGTH
46-3120	Set of 24 instruments with 2 cases Includes:	
46-3121	Curette, Forward Straight, 0	9½ in 241 mm
46-3122	Curette, Forward Straight, 1	9½ in 241 mm
46-3123	Curette, Forward Straight, 2	9½ in 241 mm
46-3124	Curette, Forward Angle, 0	9½ in 241 mm
46-3125	Curette, Forward Angle, 1	9½ in 241 mm
46-3126	Curette, Forward Angle, 2	9½ in 241 mm
46-3127	Curette, Forward Down, 0	9½ in 241 mm
46-3128	Curette, Forward Down, 1	9½ in 241 mm
46-3129	Curette, Forward Down, 2	9½ in 241 mm
46-3130	Curette, Backward Straight, 0	9½ in 241 mm
46-3131	Curette, Backward Straight, 1	9½ in 241 mm
46-3132	Curette, Backward Straight, 2	9½ in 241 mm
46-3133	Curette, Backward Angle, 0	9½ in 241 mm
46-3134	Curette, Backward Angle, 1	9½ in 241 mm
46-3135	Curette, Backward Angle, 2	9½ in 241 mm
46-3136	Curette, Backward Down, 0	9½ in 241 mm
46-3137	Curette, Backward Down, 1	9½ in 241 mm
46-3138	Curette, Backward Down, 2	9½ in 241 mm
46-3139	Penfield Dissector #1	9½ in 241 mm
46-3140	Penfield Dissector #2	9½ in 241 mm
46-3142	Penfield Dissector #4	9½ in 241 mm
46-3141	Nerve Hook	9½ in 241 mm
46-3143	Bone Waxer	9½ in 241 mm
46-3144	Spine Probe	9½ in 241 mm
46-3144	Storage/Sterilizing Case for 12 instruments	

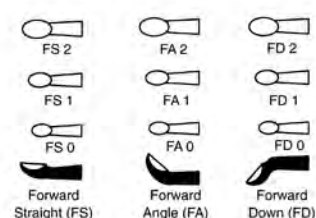
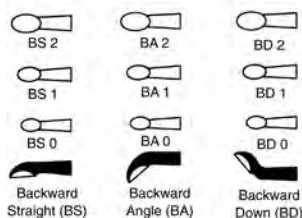

Curettes

Hardy™ Bayonet Curette

Offset, Black Handles, Tip Configuration Marked On Handle

CODE	DESCRIPTION	LENGTH
67-7139	2 mm Ring Angled Up	9½ in 241 mm
67-7140	2 mm Ring Angled Up	11 in 280 mm
67-7142	3 mm Ring Angled Up	11 in 280 mm
67-7144	5 mm Ring Angled Up	11 in 280 mm
67-7141	2 mm Ring Angled Up	13 in 330 mm
67-7143	3 mm Ring Angled Up	13 in 330 mm
67-7145	5 mm Ring Angled Up	13 in 330 mm
67-7147	2 mm Ring Angled Down	11 in 280 mm
67-7149	3 mm Ring Angled Down	11 in 280 mm
67-7151	5 mm Ring Angled Down	11 in 280 mm
67-7148	2 mm Ring Angled Down	13 in 330 mm
67-7150	3 mm Ring Angled Down	13 in 330 mm
67-7152	5 mm Ring Angled Down	13 in 330 mm
67-7153	2 mm Ring Angled 90° Left	9½ in 241 mm
67-7154	2 mm Ring Angled 90° Left	11 in 280 mm
67-7156	3 mm Ring Angled 90° Left	11 in 280 mm
67-7158	5 mm Ring Angled 90° Left	11 in 280 mm
67-7155	2 mm Ring Angled 90° Left	13 in 330 mm
67-7157	3 mm Ring Angled 90° Left	13 in 330 mm
67-7159	5 mm Ring Angled 90° Left	13 in 330 mm
67-7160	2 mm Ring Angled 45° Left	9½ in 241 mm
67-7161	2 mm Ring Angled 45° Left	11 in 280 mm
67-7163	3 mm Ring Angled 45° Left	11 in 280 mm
67-7165	5 mm Ring Angled 45° Left	11 in 280 mm
67-7162	2 mm Ring Angled 45° Left	13 in 330 mm
67-7164	3 mm Ring Angled 45° Left	13 in 330 mm
67-7166	5 mm Ring Angled 45° Left	13 in 330 mm
67-7167	5 mm Distal Tip Curved Right	11 in 280 mm
67-7168	5 mm Distal Tip Curved Right	13 in 330 mm
67-7169	5 mm Distal Tip Curved Left	11 in 280 mm
67-7170	5 mm Distal Tip Curved Left	13 in 330 mm



OBESE PATIENT

Curettes



46-3410

Karlin™ PG Magnum Cup Curette

Cup Curette, Forward

CODE	DESCRIPTION	WORKING DISTANCE	HANDLE DIAMETER	HANDLE LENGTH	TOTAL LENGTH
46-3410	46-3410 Karlin™ PG MAGNUM Cup Curettes Large capacity cup sizes permit rapid tissue removal Set of 12 Cup Curettes with Case includes:				
46-3411	Straight 7 mm	4 ⁷ / ₁₀ in 120 mm	1 ³ / ₂₅ in 30 mm	7 ⁴ / ₅ in 200 mm	12 ³ / ₅ in 320 mm
46-3412	Straight 9 mm	4 ⁷ / ₁₀ in 120 mm	1 ³ / ₂₅ in 30 mm	7 ⁴ / ₅ in 200 mm	12 ³ / ₅ in 320 mm
46-3413	Straight 11 mm	4 ⁷ / ₁₀ in 120 mm	1 ³ / ₂₅ in 30 mm	7 ⁴ / ₅ in 200 mm	12 ³ / ₅ in 320 mm
46-3414	Straight 13 mm	4 ⁷ / ₁₀ in 120 mm	1 ³ / ₂₅ in 30 mm	7 ⁴ / ₅ in 200 mm	12 ³ / ₅ in 320 mm
46-3415	Straight 15 mm	4 ⁷ / ₁₀ in 120 mm	1 ³ / ₂₅ in 30 mm	7 ⁴ / ₅ in 200 mm	12 ³ / ₅ in 320 mm
46-3416	Straight 17 mm	4 ⁷ / ₁₀ in 120 mm	1 ³ / ₂₅ in 30 mm	7 ⁴ / ₅ in 200 mm	12 ³ / ₅ in 320 mm
46-3417	Straight 19 mm	4 ⁷ / ₁₀ in 120 mm	1 ³ / ₂₅ in 30 mm	7 ⁴ / ₅ in 200 mm	12 ³ / ₅ in 320 mm
46-3418	Angle 7 mm	4 ⁷ / ₁₀ in 120 mm	1 ³ / ₂₅ in 30 mm	7 ⁴ / ₅ in 200 mm	12 ³ / ₅ in 320 mm
46-3419	Angle 9 mm	4 ⁷ / ₁₀ in 120 mm	1 ³ / ₂₅ in 30 mm	7 ⁴ / ₅ in 200 mm	12 ³ / ₅ in 320 mm
46-3420	Angle 11 mm	4 ⁷ / ₁₀ in 120 mm	1 ³ / ₂₅ in 30 mm	7 ⁴ / ₅ in 200 mm	12 ³ / ₅ in 320 mm
46-3421	Down Pushing 7 mm	4 ⁷ / ₁₀ in 120 mm	1 ³ / ₂₅ in 30 mm	7 ⁴ / ₅ in 200 mm	12 ³ / ₅ in 320 mm
46-3422	Down Pushing 9 mm	4 ⁷ / ₁₀ in 120 mm	1 ³ / ₂₅ in 30 mm	7 ⁴ / ₅ in 200 mm	12 ³ / ₅ in 320 mm

Curettes

Karlin™ Magnum PG Cup Curette

Forward Angle, PG Magnum Style Handle

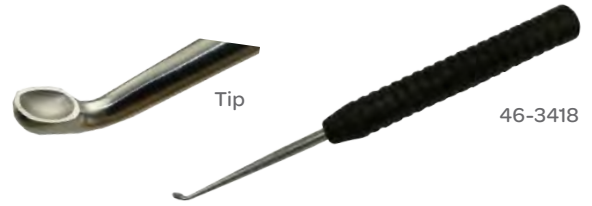

CODE	DESCRIPTION	WORKING DISTANCE		HANDLE DIAMETER		HANDLE LENGTH		TOTAL LENGTH	
46-3418	PG 7 mm	4 ⁷ / ₁₀ in	120 mm	1 ³ / ₂₃ in	30 mm	7 ⁴ / ₅ in	200 mm	12 ³ / ₅ in	320 mm
46-3419	PG 9 mm	4 ⁷ / ₁₀ in	120 mm	1 ³ / ₂₃ in	30 mm	7 ⁴ / ₅ in	200 mm	12 ³ / ₅ in	320 mm
46-3420	PG 11 mm	4 ⁷ / ₁₀ in	120 mm	1 ³ / ₂₃ in	30 mm	7 ⁴ / ₅ in	200 mm	12 ³ / ₅ in	320 mm

Karlin™ Magnum PG Cup Curette

Forward Down Pushing, PG Magnum Style Handle



CODE	DESCRIPTION	WORKING DISTANCE		HANDLE DIAMETER		HANDLE LENGTH		TOTAL LENGTH	
46-3421	PG 7 mm	4 ⁷ / ₁₀ in	120 mm	1 ³ / ₂₅ in	30 mm	7 ⁴ / ₅ in	200 mm	12 ³ / ₅ in	320 mm
46-3422	PG 9 mm	4 ⁷ / ₁₀ in	120 mm	1 ³ / ₂₅ in	30 mm	7 ⁴ / ₅ in	200 mm	12 ³ / ₅ in	320 mm

Karlin™ PG Magnum Cup Curette

Forward Straight, PG Magnum Style Handle



CODE	DESCRIPTION	WORKING DISTANCE		HANDLE DIAMETER		HANDLE LENGTH		TOTAL LENGTH	
46-3411	PG 7 mm	4 ⁷ / ₁₀ in	120 mm	1 ³ / ₂₅ in	30 mm	7 ⁴ / ₅ in	200 mm	12 ³ / ₅ in	320 mm
46-3412	PG 9 mm	4 ⁷ / ₁₀ in	120 mm	1 ³ / ₂₅ in	30 mm	7 ⁴ / ₅ in	200 mm	12 ³ / ₅ in	320 mm
46-3413	PG 11 mm	4 ⁷ / ₁₀ in	120 mm	1 ³ / ₂₅ in	30 mm	7 ⁴ / ₅ in	200 mm	12 ³ / ₅ in	320 mm
46-3414	PG 13 mm	4 ⁷ / ₁₀ in	120 mm	1 ³ / ₂₅ in	30 mm	7 ⁴ / ₅ in	200 mm	12 ³ / ₅ in	320 mm
46-3415	PG 15 mm	4 ⁷ / ₁₀ in	120 mm	1 ³ / ₂₅ in	30 mm	7 ⁴ / ₅ in	200 mm	12 ³ / ₅ in	320 mm
46-3416	PG 17 mm	4 ⁷ / ₁₀ in	120 mm	1 ³ / ₂₅ in	30 mm	7 ⁴ / ₅ in	200 mm	12 ³ / ₅ in	320 mm
46-3417	PG 19 mm	4 ⁷ / ₁₀ in	120 mm	1 ³ / ₂₅ in	30 mm	7 ⁴ / ₅ in	200 mm	12 ³ / ₅ in	320 mm

Curettes

Spinal Disc Curette

Forward Angle, 30°

CODE	DESCRIPTION	LENGTH
677219	2.5 x 4 mm	11 in 280 mm
677218	3 x 5 mm	11 in 280 mm



677218

Karlin™ XL Magnum Cup Curette

Down Pushing, XL Magnum Style Handle

CODE	DESCRIPTION	LENGTH
46-3234	7 mm	13 ¼ in 337 mm
46-3235	9 mm	13 ¼ in 337 mm

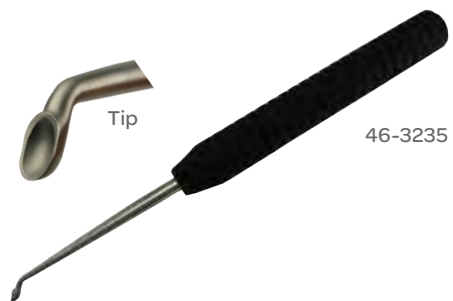

46-3235

Karlin™ XL Magnum Cup Curette

Extra Long Curettes, Black Handles, Lightweight, Set of 12

CODE		LENGTH	CUP
46-3225	Set Includes:	13 ¼ in	337 mm
46-3226	Forward Straight	13 ¼ in	7 mm
46-3227	Forward Straight	13 ¼ in	9 mm
46-3228	Forward Straight	13 ¼ in	11 mm
46-3229	Forward Straight	13 ¼ in	13 mm
46-3230	Forward Straight	13 ¼ in	15 mm
46-3236	Forward Straight	13 ¼ in	17 mm
46-3237	Forward Straight	13 ¼ in	19 mm
46-3231	Forward Angle	13 ¼ in	7 mm
46-3232	Forward Angle	13 ¼ in	9 mm
46-3233	Forward Angle	13 ¼ in	11 mm
46-3234	Down Pushing	13 ¼ in	7 mm
46-3235	Down Pushing	13 ¼ in	9 mm
46-3222	Storage/Sterilizing case for 12 XL Magnum instruments	13 ¼ in	



46-3325

Curettes



46-3400

Karlin™ PG Magnum Ring Curettes

Unique, broad-neck fulcrum provides atraumatic leverage on opposing vertebrae end plates. Dual-coned, precision sharpened rings facilitate rapid, efficient bone sculpting and removal. Each instrument engraved with depth indicator to minimize potential for deep penetration.

CODE		WORKING DISTANCE	HANDLE DIAMETER	HANDLE LENGTH	LENGTH
46-3400	Set of 6 Includes:				
46-3401	Ring Curette, Straight 6 mm	4 7/10 in 120 mm	1 3/25 in 30 mm	7 4/5 in 200 mm	12 3/5 in 320 mm
46-3402	Ring Curette, Straight 8 mm	4 7/10 in 120 mm	1 3/25 in 30 mm	7 4/5 in 200 mm	12 3/5 in 320 mm
46-3403	Ring Curette, Straight 10 mm	4 7/10 in 120 mm	1 3/25 in 30 mm	7 4/5 in 200 mm	12 3/5 in 320 mm
46-3404	Ring Curette, Angle 6 mm	4 7/10 in 120 mm	1 3/25 in 30 mm	7 4/5 in 200 mm	12 3/5 in 320 mm
46-3405	Ring Curette, Angle 8 mm	4 7/10 in 120 mm	1 3/25 in 30 mm	7 4/5 in 200 mm	12 3/5 in 320 mm
46-3406	Ring Curette, Angle 10 mm	4 7/10 in 120 mm	1 3/25 in 30 mm	7 4/5 in 200 mm	12 3/5 in 320 mm
46-3407	PG Magnum Sterilizing Case				

Karlin™ Magnum XL Magnum Cup Curette

Forward Straight, XL Magnum Style Handle

CODE	DESCRIPTION	LENGTH
46-3226	7 mm	13 1/4 in 337 mm
46-3227	9 mm	13 1/4 in 337 mm
46-3228	11 mm	13 1/4 in 337 mm
46-3229	13 mm	13 1/4 in 337 mm
46-3230	15 mm	13 1/4 in 337 mm
46-3236	17 mm	13 1/4 in 337 mm
46-3237	19 mm	13 1/4 in 337 mm



46-3227

Karlin™ XL Magnum Cup Curette

Forward Angle, XL Magnum Style Handle

CODE	DESCRIPTION	LENGTH
46-3231	7 mm	13 1/4 in 337 mm
46-3232	9 mm	13 1/4 in 337 mm
46-3233	11 mm	13 1/4 in 337 mm

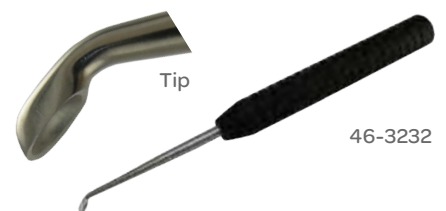

46-3232

Curettes



Karlin™ PG Magnum Ring Curette

CODE	DESCRIPTION	WORKING DISTANCE	HANDLE DIAMETER	HANDLE LENGTH	TOTAL LENGTH
46-3401	Straight, PG 6 mm	4 ⁹ / ₁₀ in 120 mm	1 ³ / ₂₅ in 30 mm	7 ⁴ / ₅ in 200 mm	12 ³ / ₅ in 320 mm
46-3402	Straight, PG 8 mm	4 ⁹ / ₁₀ in 120 mm	1 ³ / ₂₅ in 30 mm	7 ⁴ / ₅ in 200 mm	12 ³ / ₅ in 320 mm
46-3403	Angle, PG 6 mm	4 ⁹ / ₁₀ in 120 mm	1 ³ / ₂₅ in 30 mm	7 ⁴ / ₅ in 200 mm	12 ³ / ₅ in 320 mm
46-3404	Angle, PG 6 mm	4 ⁹ / ₁₀ in 120 mm	1 ³ / ₂₅ in 30 mm	7 ⁴ / ₅ in 200 mm	12 ³ / ₅ in 320 mm
46-3405	Angle, PG 8 mm	4 ⁹ / ₁₀ in 120 mm	1 ³ / ₂₅ in 30 mm	7 ⁴ / ₅ in 200 mm	12 ³ / ₅ in 320 mm
46-3406	Angle, PG 10 mm	4 ⁹ / ₁₀ in 120 mm	1 ³ / ₂₅ in 30 mm	7 ⁴ / ₅ in 200 mm	12 ³ / ₅ in 320 mm

Karlin™ XL Magnum Ring Curette

Ring, XL Angled, XL Magnum Style Handle

CODE	DESCRIPTION	LENGTH
46-3219	6 mm	13 ¹ / ₄ in 337 mm
46-3220	8 mm	13 ¹ / ₄ in 337 mm
46-3221	10 mm	13 ¹ / ₄ in 337 mm



Karlin™ XL Magnum Ring Curette

Ring, XL Straight, XL Magnum Style Handle

CODE	DESCRIPTION	LENGTH
46-3216	6 mm	13 ¹ / ₄ in 337 mm
46-3217	8 mm	13 ¹ / ₄ in 337 mm
46-3221	10 mm	13 ¹ / ₄ in 337 mm



Karlin™ XL Magnum Ring Curette

Karlin™ XL Magnum Ring Curettes, Extra Long Curettes, Black Handles, Lightweight, Set of 6

CODE	DESCRIPTION	HANDLE LENGTH	HANDLE DIAMETER	LENGTH
46-3215	Set of six with case Includes:			
46-3216	Straight, 6 mm	13 ¹ / ₄ in 210 mm	1 ¹ / ₄ in 320 mm	13 ¹ / ₄ in 337 mm
46-3217	Straight, 8 mm	13 ¹ / ₄ in 210 mm	1 ¹ / ₄ in 320 mm	13 ¹ / ₄ in 337 mm
46-3218	Straight, 10 mm	13 ¹ / ₄ in 210 mm	1 ¹ / ₄ in 320 mm	13 ¹ / ₄ in 337 mm
46-3219	Angled, 6 mm	13 ¹ / ₄ in 210 mm	1 ¹ / ₄ in 320 mm	13 ¹ / ₄ in 337 mm
46-3220	Angled, 8 mm	13 ¹ / ₄ in 210 mm	1 ¹ / ₄ in 320 mm	13 ¹ / ₄ in 337 mm
46-3221	Angled, 10 mm	13 ¹ / ₄ in 210 mm	1 ¹ / ₄ in 320 mm	13 ¹ / ₄ in 337 mm
46-3222	Storage/Sterilizing Case for 12			



46-3215

Curettes

Spinal Curette

Straight

CODE	DESCRIPTION	LENGTH
23-1081	# 000	11 in 279 mm
23-1082	# 00	11 in 279 mm
23-1083	# 0	11 in 279 mm
23-1084	# 1	11 in 279 mm
23-1085	# 2	11 in 279 mm
23-1086	# 3	11 in 279 mm
23-1087	# 4	11 in 279 mm
23-1088	# 5	11 in 279 mm
23-1089	# 6	11 in 279 mm

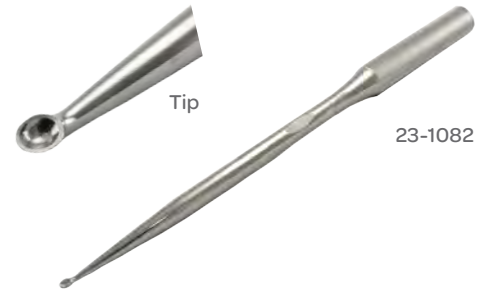

OBESE PATIENT

Spinal Curette

Malleable Shaft

CODE	SHAFT	LENGTH
677390	1 mm	9 ½ in 241 mm
677391	1.5 mm	9 ½ in 241 mm
677392	2 mm	9 ½ in 241 mm
677393	2.5 mm	9 ½ in 241 mm
677394	3 mm	9 ½ in 241 mm
677395	3.5 mm	9 ½ in 241 mm
677396	4 mm	9 ½ in 241 mm
677397	4.5 mm	9 ½ in 241 mm
677398	5 mm	9 ½ in 241 mm



Dissectors

Penfield Dissector

Slightly Curved Blunt Dissector, Double-Ended

CODE	TIP	LENGTH
65-1019	#5	11 ½ in 272 mm



Dissectors

Garrett Vascular Dissector

Slightly Curved Blunt Dissector, Double-Ended

CODE	TIP	LENGTH
677410	#1	12½ in 318 mm
677412	#2	12½ in 318 mm
677414	#3	12½ in 318 mm
677416	#4	12½ in 318 mm
677418	#5	12½ in 318 mm
677411	#1	13½ in 343 mm
677413	#2	13½ in 343 mm
677415	#3	13½ in 343 mm
677417	#4	13½ in 343 mm
677419	#5	13½ in 343 mm



677411

Elevators

Cushing Elevator

CODE	TIP	LENGTH
677034	Sharp Rounded Edge	9½ in 241 mm
677035	Sharp Rounded Edge	10½ in 266 mm
677036	Sharp Square Edge	9½ in 241 mm
677037	Sharp Square Edge	10½ in 266 mm



677034

Cobb Elevator

CODE	WIDTH	LENGTH
26-5023	½ in	14 in 355 mm
26-5020	⅝ in	14 in 355 mm
26-5021	¾ in	14 in 355 mm
26-5022	1 in	14 in 355 mm



26-5021

Cobb Elevator

CODE	SHARP ROUNDED EDGE	LENGTH
677028	⅜ in	12 in
677030	½ in	12 in
677032	¾ in	12 in
677029	⅜ in	13 in
677031	½ in	13 in
677033	¾ in	13 in



677028

Elevators



46-3425

Karlin™ PG Magnum Cobb Elevator

CODE	TIP	HANDLE LENGTH	HANDLE DIAMETER	WORKING DISTANCE	LENGTH
46-3425	Set of 6 COBB Elevators with Case includes:				
46-3426	Straight 10 mm	4 ⁹ / ₁₀ in 200 mm	1 ³ / ₂₅ in 200 mm	4 ⁷ / ₁₀ in 120 mm	12 ³ / ₅ in 320 mm
46-3427	Straight 15 mm	4 ⁹ / ₁₀ in 200 mm	1 ³ / ₂₅ in 200 mm	4 ⁷ / ₁₀ in 120 mm	12 ³ / ₅ in 320 mm
46-3428	Straight 20 mm	4 ⁹ / ₁₀ in 200 mm	1 ³ / ₂₅ in 200 mm	4 ⁷ / ₁₀ in 120 mm	12 ³ / ₅ in 320 mm
46-3429	Straight 25 mm	4 ⁹ / ₁₀ in 200 mm	1 ³ / ₂₅ in 200 mm	4 ⁷ / ₁₀ in 120 mm	12 ³ / ₅ in 320 mm
46-3430	Straight 30 mm	4 ⁹ / ₁₀ in 200 mm	1 ³ / ₂₅ in 200 mm	4 ⁷ / ₁₀ in 120 mm	12 ³ / ₅ in 320 mm
46-3431	Straight 35 mm	4 ⁹ / ₁₀ in 200 mm	1 ³ / ₂₅ in 200 mm	4 ⁷ / ₁₀ in 120 mm	12 ³ / ₅ in 320 mm
46-3432	Sterilizing Case for any 12 PG MAGNUM Instruments				



46-3240

Karlin™ XL MAGNUM Cobb Elevators Extra Length (XL)

Black Handles, Allow Two-Handed Control. Sharp, Broad Instruments Designed To Facilitate Soft Tissue Elevation And Removal

CODE	TIP	HANDLE DIAMETER	LENGTH
46-3240	Set of 6 in case for twelve instruments includes:		
46-3241	10 mm	1 ¹ / ₄ in 32 mm	12 ³ / ₅ in 320 mm
46-3242	15 mm	1 ¹ / ₄ in 32 mm	12 ³ / ₅ in 320 mm
46-3243	20 mm	1 ¹ / ₄ in 32 mm	12 ³ / ₅ in 320 mm
46-3244	25 mm	1 ¹ / ₄ in 32 mm	12 ³ / ₅ in 320 mm
46-3245	30 mm	1 ¹ / ₄ in 32 mm	12 ³ / ₅ in 320 mm
46-3246	35 mm	1 ¹ / ₄ in 32 mm	12 ³ / ₅ in 320 mm
46-3222	Sterilizing Case for any 12 PG Magnum Instruments		

Elevators

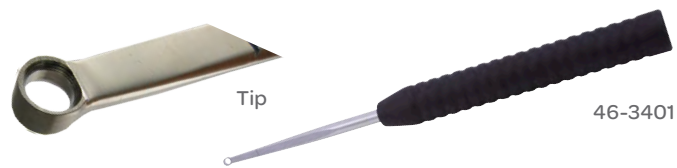

Karlin™ PG Magnum Cobb Elevator

Straight, with PG Magnum Handle

CODE	DESCRIPTION	WORKING DISTANCE	HANDLE DIAMETER	HANDLE LENGTH	TOTAL LENGTH
46-3406	10 mm	4 ⁷ / ₁₀ in 120 mm	1 ³ / ₂₅ in 30 mm	7 ⁴ / ₅ in 200 mm	12 ³ / ₅ in 320 mm
46-3401	15 mm	4 ⁷ / ₁₀ in 120 mm	1 ³ / ₂₅ in 30 mm	7 ⁴ / ₅ in 200 mm	12 ³ / ₅ in 320 mm
46-3403	20 mm	4 ⁷ / ₁₀ in 120 mm	1 ³ / ₂₅ in 30 mm	7 ⁴ / ₅ in 200 mm	12 ³ / ₅ in 320 mm
46-3404	25 mm	4 ⁷ / ₁₀ in 120 mm	1 ³ / ₂₅ in 30 mm	7 ⁴ / ₅ in 200 mm	12 ³ / ₅ in 320 mm
46-3402	30 mm	4 ⁷ / ₁₀ in 120 mm	1 ³ / ₂₅ in 30 mm	7 ⁴ / ₅ in 200 mm	12 ³ / ₅ in 320 mm
46-3405	35 mm	4 ⁷ / ₁₀ in 120 mm	1 ³ / ₂₅ in 30 mm	7 ⁴ / ₅ in 200 mm	12 ³ / ₅ in 320 mm

Karlin™ XL Magnum Cobb Elevator

With XL Magnum Handle

CODE	DESCRIPTION	LENGTH
46-3241	10 mm	13 ¹ / ₄ in 337 mm
46-3242	15 mm	13 ¹ / ₄ in 337 mm
46-3243	20 mm	13 ¹ / ₄ in 337 mm
46-3244	25 mm	13 ¹ / ₄ in 337 mm
46-3245	30 mm	13 ¹ / ₄ in 337 mm
46-3246	35 mm	13 ¹ / ₄ in 337 mm



Woodson Elevator

CODE	DESCRIPTION	LENGTH
67-7039	3 mm and 4 mm Spatula 3 x 10 mm and 4 x 12 mm	12 in 305 mm
67-7038	3 mm and 4 mm Spatula 3 x 10 mm and 4 x 12 mm	12 in 305 mm



Forceps (General)

Schmidt Forceps

CODE	DESCRIPTION	LENGTH
17-2157	Closed Ring	10 in 254 mm



Forceps (Tissue)

Tissue Forceps

Right Angled

CODE	LENGTH
32-3551	12¼ in 311 mm
32-3552	14 in 355 mm



Forceps (Dressing)

Thumb Forceps

CODE	JAWS	LENGTH
32-3541	3.4 mm	14 in 356 mm



Forceps (Bone Cutting)

Horsley Bone Cutting Forceps

Double-Action, Curved Shaft

CODE	JAW	LENGTH
30-1298	Angular	10½ in 267 mm

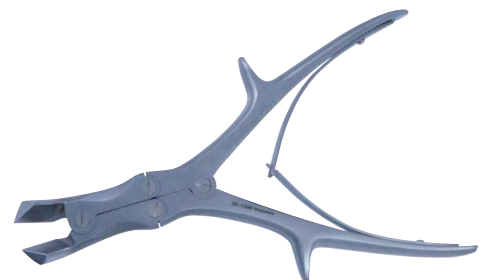

Forceps (Bone Cutting)

Stille-Liston Bone Forceps

Double-Action

CODE	DESCRIPTION	LENGTH
30-1295	Straight	10 ½ in 267 mm
30-1296	Curved	10 ½ in 267 mm



30-1295

Forceps (Intestine)

Bridge Deep Surgical Forceps

CODE	DESCRIPTION	LENGTH
30-4700	Curved	11 in 279 mm



30-4700

Forceps (Dressing)

Dressing Forceps

CODE	DESCRIPTION	TIP WIDTH	LENGTH
91-5422	Insulated		10 in 250 mm
30-4138	Serrated	3 mm	10 in 254 mm
30-4139	Serrated	3.4 mm	12 in 305 mm



30-4138

Dressing Forceps

Standard Pattern, Fine Serrated Handle

CODE	LENGTH
06-0025	10 in 254 mm
06-0030	12 in 305 mm
06-0035	14 in 350 mm
06-0040	16 in 405 mm
06-0045	18 in 455 mm

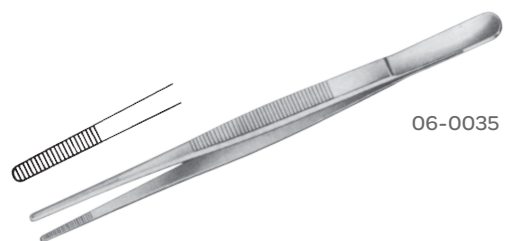

06-0035

Forceps (Dressing)

Dressing Forceps

Non-Magnetic, Titanium, Serrated, for Interventional MRI

CODE	TIP WIDTH	LENGTH
65-2407	3 mm	10 in 254 mm



Potts-Smith Dressing Forceps

CODE	DESCRIPTION	LENGTH
30-8022	Serrated	9 3/4 in 248 mm
30-8122	Serrated	12 in 305 mm
06-4638	Serrated	14 in 350 mm

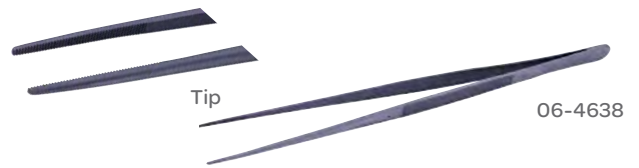

Forceps

General Surgery Opti-Length® Forceps

CODE	TIP WIDTH	LENGTH
67-7584	2 mm	10 in 254 mm
67-7585	3 mm	10 in 254 mm
67-7586	2 mm	12 in 305 mm
67-7587	2 mm	12 in 305 mm



Classic Plus® Opti-Length® Forceps

Fine Tungsten Carbide Inserts

CODE	TIP WIDTH	LENGTH
677582	2 mm	8 in 203 mm
677583	3 mm	8 in 203 mm
677584	2 mm	10 in 254 mm
677585	2 mm	10 in 254 mm
677587	2 mm	12 in 305 mm
677586	3 mm	12 in 305 mm



Meeker Forceps

CODE	TIP WIDTH	LENGTH
30-4701	Right Angle, 10 mm	14 in 356 mm

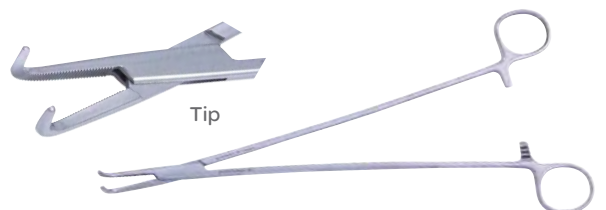

Forceps (Dressing)

Single Tuttle Intestinal Forceps

CODE	TIP	LENGTH
67-7601	Fenestrated 8 mm	12 in 305 mm



Forceps (Hemostatic)

Gemini Forceps

CODE	TIP	LENGTH
54-7266	Right Angle	16 in 405 mm

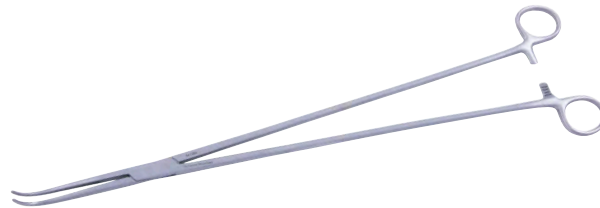

Gemini Hemostatic Forceps

Delicate 80° Curve

CODE	TIP	LENGTH
677615	1.5 mm	14 in 356 mm



Meeker Intestinal Forceps

CODE	TIP	LENGTH
677568	10 mm Right Angle	14 in 356 mm

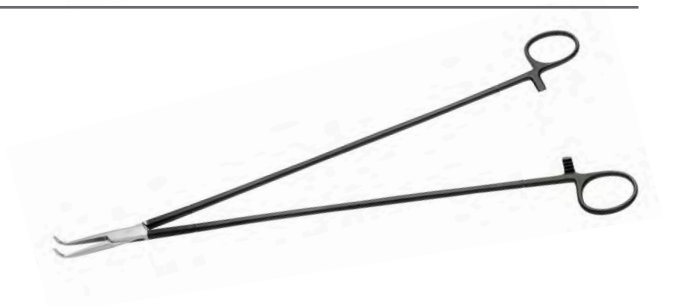

Forceps (Dressing)

Rochester-Carmalt Hemostatic Forceps

Curved

CODE	TIP	LENGTH
30-8092	Longitudinal Serrations	12¼ in 312 mm



Rochester-Pean Hemostatic Forceps

CODE	TIP	LENGTH
32-3553	Curved	12 in 305 mm
32-3554	Curved	14 in 355 mm



32-3553

Rochester-Pean Thoracic Forceps

Cross-Serrations

CODE	DESCRIPTION	LENGTH
30-8093	Curved	12 in 305 mm



Rochester-Ochsner Forceps

1x2 Teeth

CODE	TIP	LENGTH
30-8090	Straight	10 in 254 mm
32-3539	Straight	14 in 354 mm
30-8091	Curved	10 in 254 mm
30-8093	Curved	12 in 305 mm



32-3539

Schmidt Hemostatic Forceps Curved

CODE	TIP	LENGTH
677612	Curved 2 mm	12¼ in 312 mm



Forceps (Hysterectomy)

Hysterectomy Forceps

CODE	DESCRIPTION	LENGTH
67-7605	44 mm Straight, 1 x 2 Single Tooth Jaw, Off-Set Shank	12 in 305 mm
67-7602	Heavy Jaws, Double Tooth	12 in 305 mm



677602

Kocher Intestinal Forceps

CODE	DESCRIPTION	LENGTH
30-4300	Straight, Longitudinal Serrations	11 in 279 mm

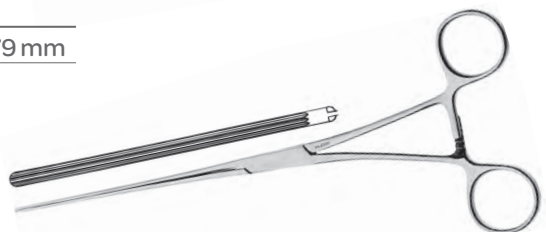

Forceps (Ligature Carrying)

DeBakey-Semb Ligature Carrying Forceps

CODE	TEETH	LENGTH OF SERRATIONS	JAW LENGTH	LENGTH
37-1132	1x2 Vascular	5/8 in 15 mm	2 1/4 in 57 mm	10 in 254 mm



Semb Ligature Carrying Forceps

CODE	DESCRIPTION	LENGTH
30-8056	Acute Curve	9 1/2 in 241 mm



Forceps (Lung & Tissue)

Duval Lung & Tissue Forceps

CODE	DESCRIPTION	LENGTH
17-3671	25 mm	12 in 305 mm

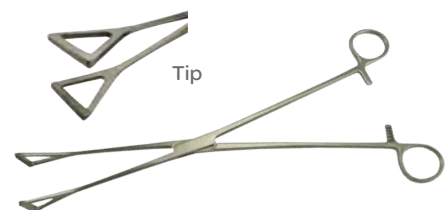

Forceps (Thoracic)

Thoarcic Clamp

CODE		LENGTH
677563	Curved, Cross Serrations	12 in 305 mm
677611	Curved, Cross Serrations	14 in 356 mm
17-0840		16 in 405 mm
17-0845		18 in 455 mm



Forceps (Sponge)

Bariatric Sponge Forceps

CODE	DESCRIPTION	LENGTH
32-3540	Serrated Jaw, Straight	14 in 355 mm



Forceps (Thoracic)

Thoracic Forceps

Crossed Serrations

CODE	DESCRIPTION	LENGTH
671000	Straight	12 in 305 mm
671001	Straight	14 in 356 mm
30-4573	Curved	10 in 254 mm
677565	Curved	12 in 305 mm
677566	Curved	14 in 356 mm



Thoracic Forceps

CODE	DESCRIPTION	LENGTH
30-8082	Curved, Delicate	9½ in 241 mm



Forceps (Tissue)

Allis Tissue Forceps

Standard Pattern

CODE	DESCRIPTION	LENGTH
50-0224	5 x 6 Teeth	9 ³ / ₄ in 245 mm
50-0245		18 in 455 mm

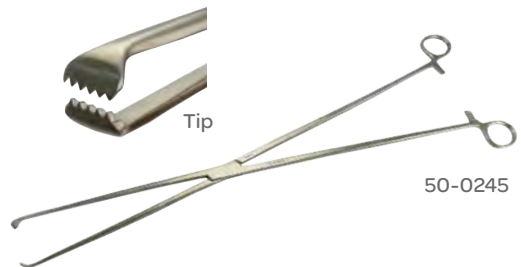

50-0245

Babcock Tissue Forceps

Straight, Serrated

CODE	DESCRIPTION	LENGTH
32-3544		12 in 305 mm
32-3545		14 in 355 mm
67-7608	Fenestrated Tip, 9.5 mm	14 in 356 mm



32-3544

Babcock Classic® Tissue Forceps

CODE	DESCRIPTION	LENGTH
32-7030	Standard Line	9 ¹ / ₂ in 242 mm

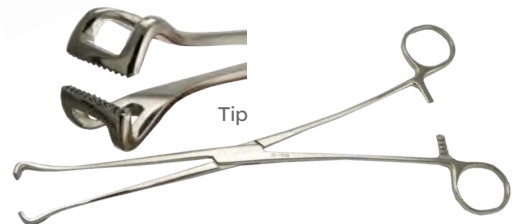

Babcock Tissue Forceps

Standard Pattern

CODE	DESCRIPTION	LENGTH
50-1024		12 in 305 mm
50-1040		16 in 405 mm
50-1045		18 in 455 mm

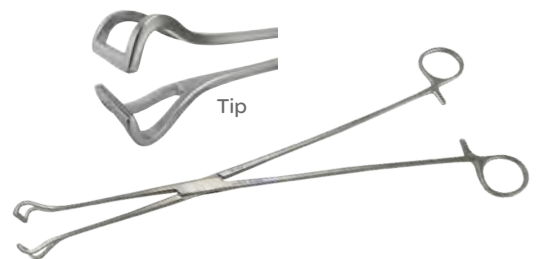

Tissue Forceps

CODE	DESCRIPTION	LENGTH
32-3542	1 x 2 Teeth	14 in 356 mm

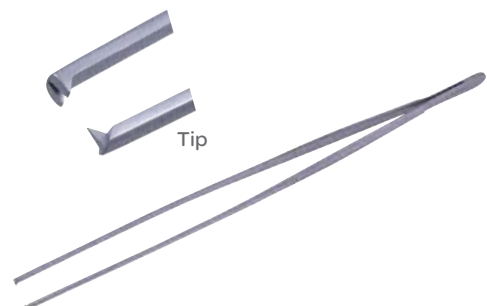

Forceps (Tissue)

Brown Tissue Forceps

Parallel Multi Teeth, Bonney Handle

CODE	DESCRIPTION	LENGTH
67-7579	3.4 mm	12 in 305 mm
67-7580	3.4 mm	14 in 355 mm
67-7581	3.4 mm	16 in 405 mm



DeBakey Thoracic Tissue Forceps

CODE	LENGTH
32-3550	14 in 356 mm

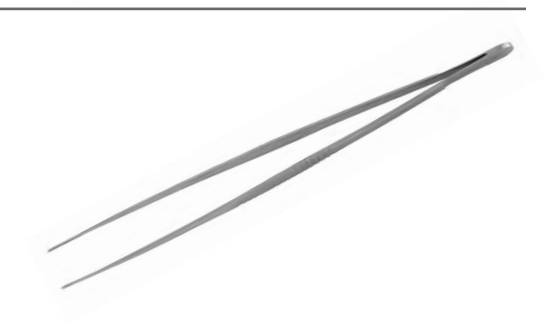

DeBakey Tissue Forceps

CODE	DESCRIPTION	LENGTH
37-1002		9½ in 241 mm
37-1003		12 in 305 mm
67-7800	Vascular Teeth, 1.5 mm, 1 x 2, Serrated Handle	12 in 305 mm
67-7801	Vascular Teeth, 2.0 mm, 1 x 2, Serrated Handle	12 in 305 mm
67-7802	Vascular Teeth, 1.5 mm, 1 x 2, Serrated Handle	14 in 355 mm
67-7803	Vascular Teeth, 2.0 mm, 1 x 2, Serrated Handle	14 in 355 mm

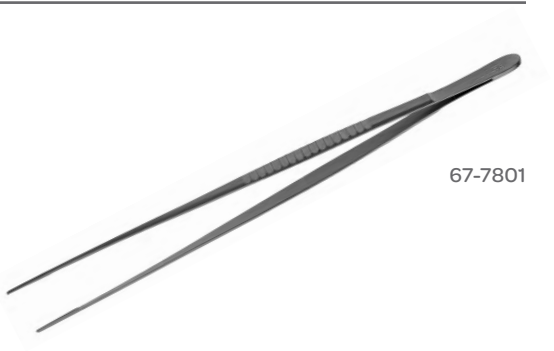

DeBakey-Collier Tissue Forceps

CODE	DESCRIPTION	LENGTH
32-3549	Angled, Serrated	14 in 355 mm

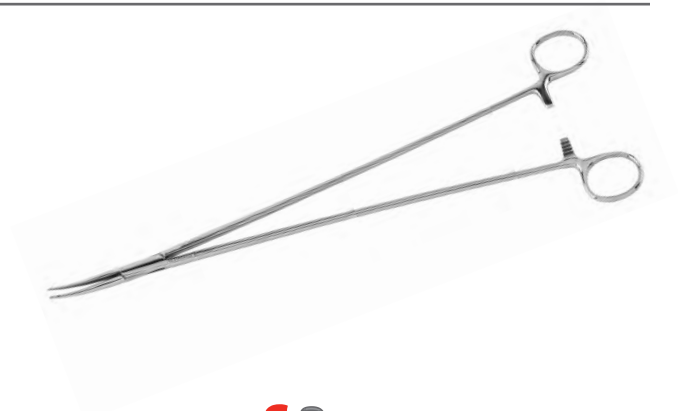

Forceps (Tissue)

Gemini Tissue Forceps

CODE	DESCRIPTION	LENGTH
32-3546	Serrated Tip	14 in 355 mm



Gerald Tissue Forceps

CODE	DESCRIPTION	LENGTH
32-3532	Fine Tungsten Carbide Inserts	10 in 254 mm
55-9006	Serrated	14 in 355 mm

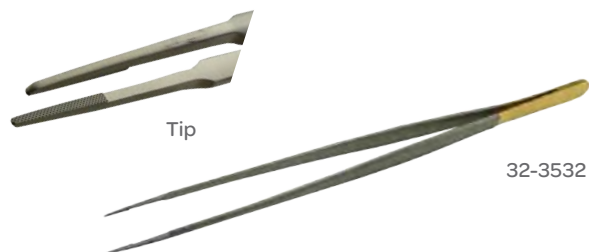

Opti-Length® Forceps

General Surgery

CODE	TIP WIDTH	LENGTH
67-7587	3 mm	12 in 305 mm



Potts-Smith Tissue Forceps

CODE	TEETH	TIP WIDTH	LENGTH
06-4835	1x2		12 in 305 mm
30-8123		1.8 mm	12 in 305 mm

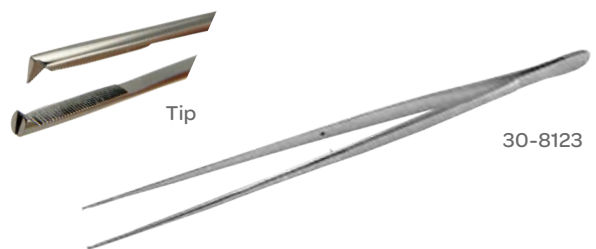

Russian Tissue Forceps

CODE	LENGTH
32-3543	14 in 355 mm

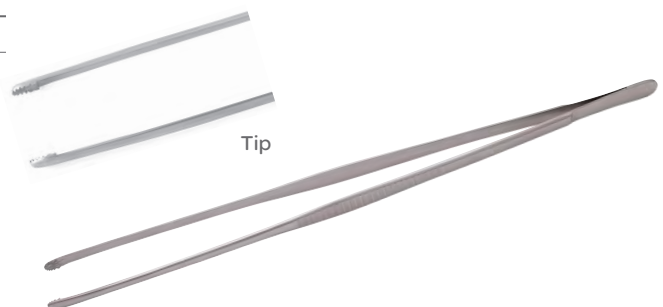

Forceps (Tissue)

Russian Tissue Forceps

CODE	DESCRIPTION	LENGTH
67-7606	Cup Tip, 7.2 mm	11 in 280 mm
67-7607	Cup Tip, 7.2 mm	12 in 305 mm



Russian Tissue Forceps

CODE	LENGTH
07-1530	14 in 355 mm

Tissue Forceps

1x2 Teeth

CODE	TIP	LENGTH
32-3557	Non-Slip, Round	10 in 254 mm
06-0525	Standard Pattern	10 in 250 mm
06-0530	Standard Pattern	12 in 305 mm
06-0535	Standard Pattern	14 in 355 mm
06-0545	Standard Pattern	18 in 455 mm
30-4156	Width 3.1 mm	10 in 254 mm
30-4157	Width 3.9 mm	12 in 305 mm



Tuttle (Singley) Tissue Forceps

CODE	LENGTH
07-1727-H	12 in 305 mm
07-1724	14 in 355 mm
07-1728	18 in 455 mm

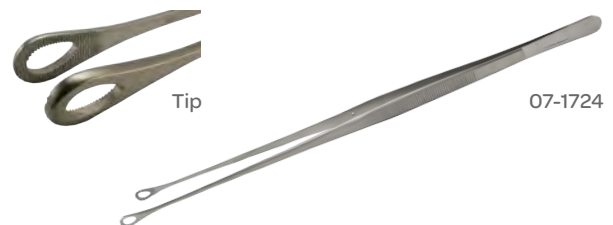

Willauer-Allis Tissue Forceps

CODE	DESCRIPTION	LENGTH
30-8085	Curved	10 in 254 mm
32-3547	3x3 Teeth	14 in 355 mm
67-7614	5x6 Teeth, 8 mm	14 in 355 mm

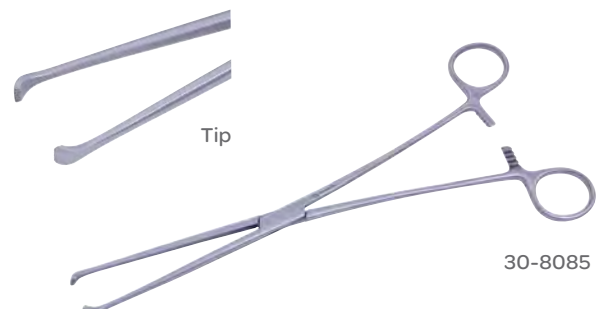

Forceps (Tissue)

Babcock Forceps

CODE	LENGTH
50-1024-H	12 in 305 mm

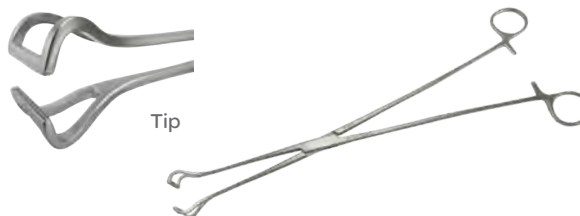

Forceps (Vascular)

DeBakey Vascular Forceps

Lighter Model

CODE	DESCRIPTION	LENGTH
37-1012		9½ in 241 mm
37-1013		12 in 305 mm
67-7609	Classic®, 1x2 Teeth	14 in 355 mm



DeBakey-Diethrich Vascular Forceps

CODE	DESCRIPTION	LENGTH
30-8133	Lighter Model	9½ in 241 mm

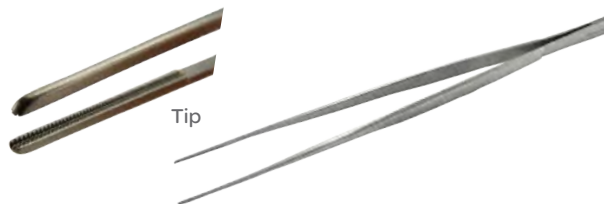

Gouges (Bone)

Bone Gouge

Straight

CODE	TIP	LENGTH
32-2000	6 mm Wide	11 in 279 mm



Hooks (Bone)

Bone Hook

Heavy-Duty

CODE	DESCRIPTION	LENGTH
32-3423	Sharp, 19 mm	9 in 229 mm
32-3424	Blunt, 19 mm	9 in 229 mm



Hooks (Nerve)

Adson Dissecting Hook

Roughened Handle

CODE	DESCRIPTION	LENGTH
67-7428	5 mm, Sharp	10 in 254 mm
67-7429	5 mm, Blunt	10 in 254 mm



Cushing Gasserian Ganglion Hook

CODE	DESCRIPTION	LENGTH
67-7430	Right Angle Tip, Blunt, 5 mm	11 in 280 mm



Dandy Nerve Hook

CODE	DESCRIPTION	LENGTH
67-7431	Right Angle Tip, Blunt 3 mm	10 in 254 mm



Hoehn Nerve Hook

CODE	DESCRIPTION	LENGTH
67-7432	Right Angle Tip, Blunt, 7 mm	10 in 254 mm



Trachea Hook

CODE	DESCRIPTION	LENGTH
67-7440	Sharp, 5 mm	12 in 305 mm



OBESE PATIENT

Hooks (Nerve)

Karlin™ Lumbar Nerve Hook

CODE	DESCRIPTION	LENGTH
46-3141		9½ in 241 mm



Malis® Nerve Hook

Titanium, Right Angle

CODE	DESCRIPTION	LENGTH
67-7433	Ball Tip, 3 mm	10 in 254 mm
67-7434	Blunt Tip, 2 mm	10 in 254 mm
67-7435	Blunt Tip, 3 mm	10 in 254 mm



Rhoton® Nerve Hook

Titanium

CODE	DESCRIPTION	ANGLE	LENGTH
67-7436	#9, Semi-Sharp, 1 mm	90°	10 in 254 mm
67-7437	#10, Blunt, 1 mm	90°	10 in 254 mm
67-7438	#11, Semi-Sharp, 3 mm	40°	10 in 254 mm



Smithwick Nerve Hook And Dissector

Double-Ended-Blunt

CODE	HOOK LENGTH	LENGTH
38-1088	⅞ in 11 mm	12 in 305 mm



Knife Handles

Knife Handle

CODE	DESCRIPTION	LENGTH
01-2746	#3	16 in 406 mm



Laparoscopic

Laparoscopic

Symmetry Surgical has a broad portfolio of laparoscopic instruments designed specifically for large or obese patients. Our extended-length laparoscopic instruments are 45 cm long, giving surgeons additional reach to aid in completion of procedures.

Visit the laparoscopic section in this catalog to see our standard as well as extended-length laparoscopic instruments.



Laparoscopic (Bookwalter®)

Bookwalter®

CODE	DESCRIPTION
50-4685	Bookwalter® Telescopic Instrument Holder



Bookwalter® Universal Flex Arm System

CODE	DESCRIPTION
504805	Bookwalter® Universal Flex Arm System Kit Includes 1 each of 504805, 504806, 504807, 504808, 504809
504806	Ring Adapter for Bookwalter® Flex Arm
504807	Lap Instrument Adapter (Spring) for Bookwalter® Flex Arm
504808	Camera Lens Adapter for Bookwalter® Flex Arm
504809	Camera Housing Adapter for Bookwalter® Flex Arm

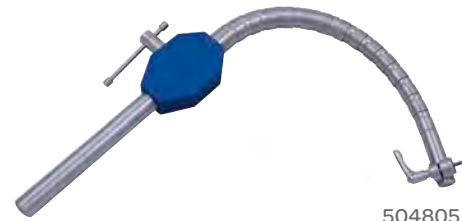

504805

Hasson "S" Retractor

CODE	DESCRIPTION	DIMENSIONS	
90-6003	2 ¼ in	6 in	152 mm
90-6004	Set of 2	6 ¼ in	160 mm
90-6002	Set of 2, 10 mm Wide		
90-6006			
90-6007		10 in	254 mm
90-6008		10 in	254 mm

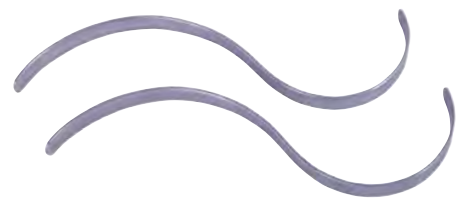

90-6002

Needle Holders

Crile Wood Needle Holder

CODE	DESCRIPTION	LENGTH
32-310	Straight Serrated Jaw	11 ³ / ₄ in 300 mm
36-2004	Fine Tungsten Carbide Jaw Inserts	10 in 254 mm
36-2005	Fine Tungsten Carbide Jaw Inserts	12 in 305 mm



Tip



32-310

DeBakey Needle Holder

Fine Tungsten Carbide Inserts,

CODE	DESCRIPTION	TIP	LENGTH
32-040	Use with 3-0 And 4-0 Suture	2 mm	12 ¹ / ₄ in



Tip

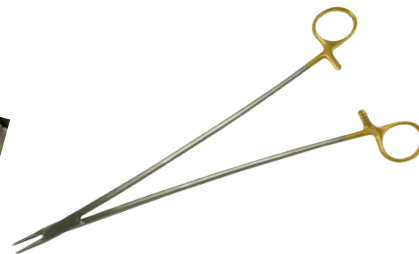

Heaney Needle Holder

Curved

CODE	DESCRIPTION	LENGTH
32-236	Fine Tungsten Carbide Inserts	12 in 305 mm
32-3687	Serrated	14 in 365 mm



32-3687

Masson Needle Holder

Fine Tungsten Carbide Inserts

CODE	DESCRIPTION	LENGTH
32-304		16 in 405 mm
32-305	Single-Action	18 in 455 mm



Tip



32-304

Needle Holders

Mayo-Hegar Needle Holder

Jaws Have Fine Tungsten Carbide Inserts

CODE	DESCRIPTION	LENGTH	
36-2019		10 in	254 mm
32-300	Use With 1-0, 2-0 Suture	11 7/8 in	301 mm
10-1828		14 in	355 mm
67-7624	2 mm	14 in	355 mm
67-7623	4 mm	14 in	355 mm



32-310

Needle Holder

Fine Tungsten Carbide Inserts

CODE	DESCRIPTION	LENGTH	
90-3038L	Curved 5 mm	17 3/4 in	450 mm



Tip

Ryder Classic Plus® Needle Holder

Fine Tungsten Carbide Inserts

CODE	DESCRIPTION	TIP	LENGTH	
36-3005	Serrated Jaw 2 mm	1.5 mm	10 in	254 mm

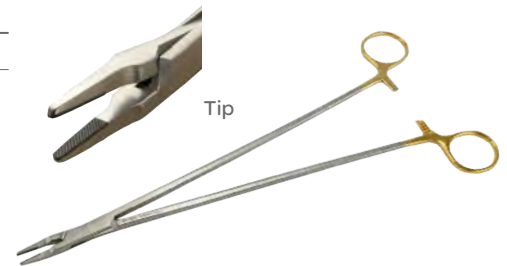

Tip

Wangensteen Classic Plus® Needle Holder

CODE	DESCRIPTION	LENGTH	
36-4020	Fine Tungsten Carbide Jaw Inserts	10 1/2 in	267 mm



Needle Holders

Crile-Wood Needle Holder

CODE	DESCRIPTION	LENGTH
32-3685	Fine Tungsten Carbide Insert	14 in 356 mm



Intracardiac Needle Holder

CODE	DESCRIPTION	LENGTH
32-368	Needle Holder	12 in 305 mm



Osteotomes



46-2001

Osteotome

CODE	DESCRIPTION	TIP WIDTH	LENGTH
46-2000	Straight	¼ in 6 mm	11 in 279 mm
46-2001	Straight	⅜ in 10 mm	11 in 279 mm
46-2002	Straight	½ in 13 mm	11 in 279 mm
46-2003	Straight	⅝ in 16 mm	11 in 279 mm
46-2004	Straight	¾ in 19 mm	11 in 279 mm
46-2005	Straight	1 in 25 mm	11 in 279 mm
46-2010	Curved	¼ in 6 mm	11 in 279 mm
46-2011	Curved	⅜ in 10 mm	11 in 279 mm
46-2012	Curved	½ in 13 mm	11 in 279 mm
46-2013	Curved	⅝ in 16 mm	11 in 279 mm
46-2014	Curved	¾ in 19 mm	11 in 279 mm
46-2015	Curved	1 in 25 mm	11 in 279 mm
46-2016	Curved	1¼ in 32 mm	11 in 279 mm



46-1019

Spinal Fusion Osteotome

CODE	DESCRIPTION	BLADE WIDTH	LENGTH
46-1025	Straight	6 mm	9½ in 241 mm
46-1019	Straight	10 mm	9½ in 241 mm
46-1024	Full Curved	6 mm	9½ in 241 mm

Pliers



Vice Grips

CODE	DESCRIPTION	LENGTH
37-4101	Vice Grips	7 in 180 mm

Probes (Spinal)



Probe With Eye

CODE	DESCRIPTION	LENGTH
49-4037	Probe	10 in 254 mm

Probes (Palpation)



Palpation Probe

CODE	DESCRIPTION	LENGTH
90-5053L	Probe	17 ³ / ₄ in 450 mm

Retractors

Balfour Abdominal Retractor

Standard Model: Fenestrated Blades 4 in Deep, with Center Blade 24-7073



CODE	MAX SPREAD
24-7017	10 in 254 mm

Balfour Abdominal Retractor



CODE	DESCRIPTION	DIMENSIONS
24-5200AA	Includes: Two Pairs Lateral Snap-On Wire Blades , Left Hand Assembly Provided Unless Specified Otherwise	8 ½ x 2 ½ x 3 ½ in 216 x 63 x 89 mm

Balfour Abdominal Retractor

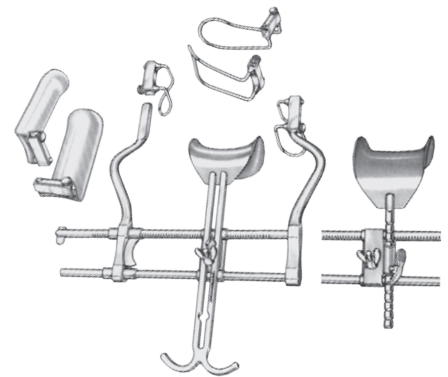

CODE	DESCRIPTION	DIMENSIONS
24-5200AAA	Includes: Two Pairs Lateral Snap-On Wire Blades, One Center Blade (Chosen From: 24-5012, 24-5014, 24-5022, 24-5024, 24-5026, 50-2428, 24-5030, 24-5032, 24-5034 or 24-5036) Left Hand Assembly Provided Unless Specified Otherwise.	8 ½ x 2 ½ x 3 ½ in 216 x 63 x 89 mm

Retractors (Bookwalter® Horizontal Bars)



Bookwalter® Lightweight Horizontal Bar

CODE	DESCRIPTION	QTY
50-4552	Table-Mounted	1



Bookwalter® Lightweight Horizontal Flex Bar

CODE	DESCRIPTION	QTY
50-4582	Table-Mounted	1

Retractors



Balfour Retractor Fourth Arm Retractor

CODE	DESCRIPTION	LENGTH
50-4526	Left	12 in 305 mm
50-4527	Right	12 in 305 mm
24-5062C	For Balfour Fourth Blade Attachment with Wing Nut	

Retractors



Balfour Supra-Pubic Retractor Blade

CODE	DESCRIPTION	BLADE
24-5024B	Deep	3 3/8 x 2 3/4 in 86 x 70 mm



37-4106

Cobra Retractor

CODE	DESCRIPTION	TIP SIZE	LENGTH
37-4105	Sharp	1 1/4 in	9 3/4 in 250 mm
37-4106	Blunt	1 1/4 in	9 3/4 in 250 mm



32-3633

Cushing Retractor

CODE	JAW LENGTH	LENGTH
32-3633	10 mm	11 in 280 mm
32-3634	11 mm	14 in 355 mm

Retractors



50-4316

Deaver Retractor

CODE	DESCRIPTION	WIDTH		LENGTH	
50-4316	#1 Ring Grip Handle	1 in	25 mm	12 in	305 mm
50-4317	#4 Ring Grip Handle	1 in	25 mm	13 in	330 mm
50-4319	#3 Ring Grip Handle	1½	38mm	12 in	305 mm
50-4320	#4 Ring Grip Handle	2 in	51 mm	12 in	305 mm
50-4321	#5 Ring Grip Handle	3 in	76 mm	12 in	305 mm
50-4303	#1 Standard Handle	1 in	25 mm	12 in	305 mm
50-4304	#2 Standard Handle	1 in	25 mm	13 in	330 mm
50-4306	#3 Standard Handle	1½ in	38 mm	12 in	305 mm
50-4307	#4 Standard Handle	2 in	51 mm	12 in	305 mm
50-4308	#5 Standard Handle	3 in	76 mm	12 in	305 mm
50-4309	#6 Standard Handle	4 in	102 mm	14 in	356 mm
67-7498	# 4 Comfort Grip Handle	2 in	51 mm	12 in	305 mm



Deaver Obese Patient Retractor

CODE	DESCRIPTION	HANDLE LENGTH		BLADE		LENGTH	
32-3635	Grip Handle	14½ in	368 mm	2½ in	640 mm	14½ in	368 mm

Retractors

Gelpi Retractor



CODE	DESCRIPTION	WIDTH	LENGTH
67-7510	Sharp, Self-Retaining	15 mm	11 in 280 mm

Harrington Retractor

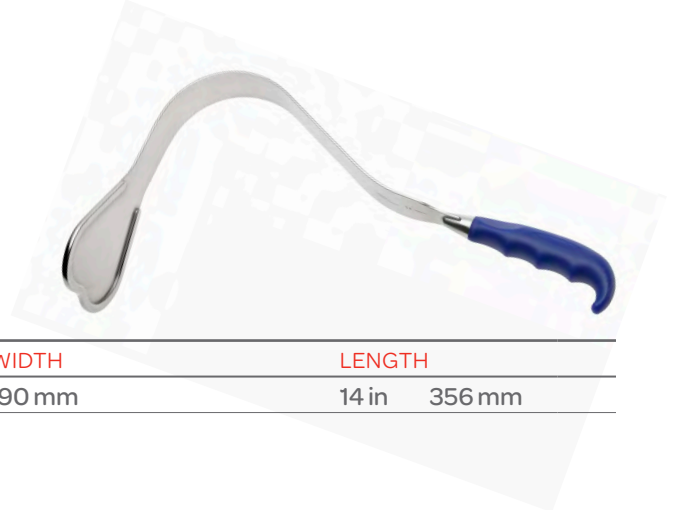

CODE	DESCRIPTION	BLADE WIDTH	LENGTH
67-7482	Comfort Grip Handle	3½ in 90 mm	14 in 356 mm

Harrington Retractor



CODE	DESCRIPTION	BLADE WIDTH	LENGTH
67-7505	Splanchnic, Lipped Distal Edge	2½ in 64 mm	20 in 508 mm

Retractors



Holsher Retractor

CODE	DESCRIPTION	BLADE WIDTH	LENGTH
50-1331	Nerve Root	$\frac{5}{16}$ in 7 mm	9 $\frac{3}{4}$ in 248 mm



50-4117

Kelly Retractor

CODE	DESCRIPTION	BLADE DIMENSION	LENGTH
50-4112	Large, Ring-Grip Handle	2 $\frac{1}{2}$ x 3 in 64 x 76 mm	10 in 254 mm
50-4117	Large, Grip Handle	2 $\frac{1}{2}$ x 3 in 64 x 76 mm	10 in 254 mm
67-7483	Grip Handle	3 x 3 in 76 x 76 mm	11 in 280 mm
67-7484	Grip Handle	3 x 4 in 76 x 102 mm	11 in 280 mm
67-7485	Grip Handle	3 x 5 in 76 x 127 mm	11 in 280 mm
67-7486	Grip Handle	3 x 3 in 76 x 76 mm	11 in 280 mm
67-7487	Grip Handle	3 x 4 in 76 x 102 mm	11 in 280 mm
67-7488	Grip Handle	3 x 5 in 76 x 127 mm	11 in 280 mm



677494

Kelly Retractor

Comfort Grip Handle

CODE	BLADE DIMENSION	LENGTH
677489	3 x 3 in 76 x 76 mm	11 in 280 mm
677490	3 x 4 in 76 x 102 mm	11 in 280 mm
677491	3 x 5 in 76 x 127 mm	11 in 280 mm
677492	3 x 3 in 76 x 76 mm	13 in 330 mm
677493	3 x 4 in 76 x 102 mm	13 in 330 mm
677494	3 x 5 in 76 x 127 mm	13 in 330 mm

Retractors



23-4701

Kelly Retractor

Ring Grip Handle

CODE	DESCRIPTION	BLADE DIMENSION		LENGTH	
50-4111	Standard Handle, Medium	2 x 2 ½ in	51 x 64 mm	9 ½ in	241 mm
50-4118	Grip Handle, XL	3 x 3 ½ in	76 x 89 mm	10 in	254 mm
23-4701	Standard Handle	1 ½ x 2 in		10 ¼ in	260 mm
23-4702	Standard Handle	2 x 2 ½ in		10 ¼ in	260 mm
23-4703	Standard Handle	2 ½ x 3 in		10 ¼ in	260 mm
23-4711	Lamb Handle	1 ¼ x 2 in		10 ¼ in	260 mm
23-4712	Lamb Handle	2 x 2 ½ in		10 ¼ in	260 mm
23-4713	Lamb Handle	2 ½ x 3 in		10 ¼ in	260 mm
23-4714	Lamb Handle	3 x 3 ½ in		10 ¼ in	260 mm
23-4715	Grip Handle	1 ½ x 2 in		10 ¼ in	260 mm
23-4716	Grip Handle	2 x 2 ½ in		10 ¼ in	260 mm
23-4717	Grip Handle	2 ½ x 3 in		10 ¼ in	260 mm
23-4718	Grip Handle	3 x 3 ½ in		10 ¼ in	260 mm



67-7470

Ollier Retractor

Blunt, Four Prongs

CODE	DESCRIPTION	WIDTH	LENGTH	
67-7470		2 ¼ in	11 in	280 mm
67-7471		2 ¼ in	13 in	330 mm

Retractors

Ribbon Retractor

22-0006

Malleable



CODE	DESCRIPTION	WIDTH		LENGTH	
22-0006	Malleable, Stainless Steel	¼ in	6 mm	8 in	203 mm
22-0012	Malleable, Stainless Steel	½ in	13 mm	8 in	203 mm
22-0017	Malleable, Stainless Steel	⅝ in	16 mm	8 in	204 mm
22-0027	Malleable, Stainless Steel	1 in	25 mm	10 in	254 mm
22-0252	Malleable, Stainless Steel	1 in	25 mm	13 in	330 mm
22-0253	Malleable, Stainless Steel	1¼ in	32 mm	13 in	330 mm
22-0254	Malleable, Stainless Steel	1½ in	38 mm	13 in	330 mm
22-0255	Malleable, Stainless Steel	2 in	51 mm	13 in	330 mm
22-0256	Malleable, Stainless Steel	2½ in	64 mm	13 in	330 mm
22-0257	Malleable, Stainless Steel	3 in	76 mm	13 in	330 mm
22-0258	Malleable, Stainless Steel	4 in	102 mm	13 in	330 mm
22-0259	Malleable, Stainless Steel	5 in	127 mm	13 in	330 mm



50-4212

Ribbon Malleable Retractor

CODE	DESCRIPTION	WIDTH		LENGTH	
50-5637	Malleable Retractor	½ in	13 mm	8 in	203 mm
50-5638	Malleable Retractor	⅝ in	16 mm	8 in	203 mm
50-5639	Malleable Retractor	¾ in	19 mm	8 in	203 mm
50-4210	Malleable Retractor	1 in	25 mm	13 in	330 mm
50-4212	Malleable Retractor	1½ in	38 mm	13 in	330 mm
50-4214	Malleable Retractor	2 in	51 mm	13 in	330 mm

Richardson Retractor

Standard Handle



50-4122

CODE	DESCRIPTION	WIDTH		LENGTH	
50-4122	Large	1½ x 1¾ in	38 x 44 mm	9½ in	241 mm
23-4550	Set of Two, Double-Ended				
23-4551	Small Only, Double-Ended				
23-4552	Large Only, Double-Ended				

Retractors



677462

Volkman Retractor

CODE	DESCRIPTION	BLADE WIDTH	LENGTH
677462	Sharp, Four Prong	25 mm	12 in 305 mm
677464	Sharp, Four Prong	25 mm	14 in 356 mm
677466	Sharp, Six Prong	40 mm	12 in 305 mm
677468	Sharp, Six Prong	40 mm	14 in 356 mm
677463	Blunt, Four Prong	25 mm	12 in 305 mm
677465	Blunt, Four Prong	25 mm	14 in 356 mm
677467	Blunt, Six Prong	40 mm	12 in 305 mm
677469	Blunt, Six Prong	40 mm	14 in 356 mm



677508

Weitlaner Retractor

Self-Retaining

CODE	DESCRIPTION	DIMENSIONS	LENGTH
677508	Sharp	2 x 1½ in 51 x 38 mm	14 in 356 mm
677509	Blunt	2 x 1½ in 51 x 38 mm	14 in 356 mm

Retractors (Abdominal)



Balfour Abdominal Retractor

Contains Two Pair of Lateral Snap on Wire Blades, One Center Blade (Other Blade Sizes Available)

CODE	CENTER BLADE	LATERAL SNAP ON BLADE DEPTH
24-5200A	2½ x 1¾ in	2½ in and 3½ in

Retractors (Blade)



24-7071

Balfour Retractor Blade

CODE	DESCRIPTION	LENGTH	
24-7071	Center Blade	2½ x 1½ in	64 x 38 mm
24-7072	Center Blade	3 x 2 in	76 x 51 mm
24-7073	Center Blade	3¾ x 2½ in	86 x 64 mm
24-7074	Center Blade	3⅛ x 2⅞ in	79 x 73 mm
24-5032B	Center Blade	2½ x 3½ in	64 x 89 mm
24-7075	Center Blade	2¾ x 4 in	70 x 102 mm



50-4524

Horgan Center Retractor Blade

CODE	DESCRIPTION	BLADE	LENGTH
50-4524	Malleable Center Blade	2 x 7 in 51 x 197 mm	14¾ in 375 mm
677507	Obese Blade, 2 in (51 mm), for Use With 504500		11 in 280 mm

Retractors (Bookwalter® Bars)

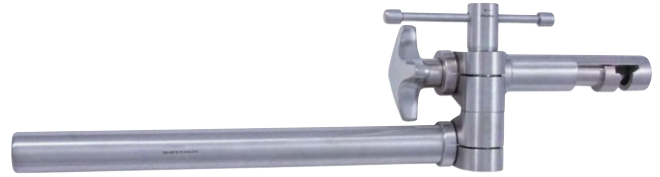

Bookwalter® Horizontal Bar

CODE	DESCRIPTION
50-4678	Horizontal Ring Holder



Bookwalter® Lightweight Horizontal Bar

CODE	DESCRIPTION
50-4618	Horizontal Bar, Lightweight Design that can be Back Fed into the Bookwalter® Coupler



50-4553

Bookwalter® Lightweight Extension Bar

50-4553 and 50-4797 Require the Use of a Second Bookwalter® Post Coupler 50-4554

CODE	DESCRIPTION	DIMENSION
50-4553	Lightweight Extension Bar	12 in 305 mm
50-4797	Lightweight Extension Bar	18 in 458 mm

Retractors (Bookwalter® Blades)



Bookwalter® Balfour Blade

CODE	DIMENSION
BW1271017	3½ x 2¾ in 89 x 70 mm

Retractors (Bookwalter® Blades)

Bookwalter® Harrington Blade

CODE	LENGTH
BW1045176	3½x10 in 89x254 mm



50-4571

Bookwalter® Kelly Blade

CODE	LENGTH
50-4571	2x6 in 51x152 mm
677496	2x7 in 51x178 mm
BW1045000	2x8 in 51x203 mm
677497	2x8 in 51x203 mm
677501	3x11 in 76x280 mm



67-7499

Bookwalter® OptiLength Malleable Blade

Malleable with Lip

CODE	WIDTH	LENGTH
677502	1½ in 38 mm	11 in 280 mm
677504	2 in 51 mm	11 in 279 mm
677499	3 in 76 mm	11 in 279 mm
677500	4 in 102 mm	11 in 279 mm
677506	2 in 51 mm	12 in 305 mm
677503	1 in 25 mm	13 in 330 mm

Retractors (Bookwalter® Blades)



Bookwalter® Radiolucent Titanium Retractor Blade

505584

CODE	WIDTH	LENGTH
505583	1 in 25 mm	7 in 178 mm
505584	1 in 25 mm	8 in 203 mm
505588	2 in 51 mm	7 in 178 mm
505589	2 in 51 mm	8 in 203 mm

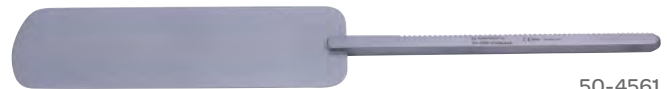

50-4561

Bookwalter® Retractor Blade

Malleable

CODE	DIMENSIONS
50-4561	2x6 in 51x152 mm
BW1043016	2x10 in 51x254 mm
50-4567	3x6 in 76x152 mm
BW1043029	3x10 in 76x254 mm
BW1045069	4x8 in 102x203 mm



50-4672

Bookwalter® Retractor Blade

Malleable with Lip

CODE	DIMENSIONS
50-4673	2x6 in 51x152 mm
50-4672	1½x6 in 38x152 mm
50-4674	3x6 in 76x152 mm

Retractors (Bookwalter® Ratchets)

Bookwalter® Ratchet

CODE	DESCRIPTION
50-4579	Flat Ratchet



Bookwalter® Ratchet Extender

CODE	DESCRIPTION
BW0338014	A Bookwalter® Extender provides the surgeon with the extra length that is sometimes needed to get a blade positioned in 'just the right spot.' Can be used with any Bookwalter® Retractor.



Bookwalter® Self-Retaining Low Profile Locking RoTilt

CODE	DESCRIPTION	QTY
50-4696	The Bookwalter® Self-Retaining Low Profile Locking RoTilt Ratchet brings all of the best features of all other ratchets into one mechanism. The low profile design, inclusive of the capacity to tilt, rotate and self-retention it is the one ratchet to build your Bookwalter® Set.	1/Each Sold Individually



Retractors (Bookwalter® Ratchets)

Bookwalter® Self-Retaining Tilt Ratchet

CODE	DESCRIPTION	QTY
50-4686	Like the 50-4580 this ratchet articulates the blade into the surgical site, it also has an additional self-retention latch that holds the ratchet onto the Bookwalter® Retractor Ring.	1/Each Sold Individually



OBESE PATIENT

Bookwalter® Tilt Ratchet Mechanism

CODE	DESCRIPTION	QTY.
50-4580	Tilt Ratchet Mechanisms	6



Bookwalter® Twister Ratchet

CODE	DESCRIPTION	QTY
BW0338015	The Bookwalter® Twister Ratchet is compatible with all Bookwalter® Ratchets and Retractor Blades. It allows controlled fine tuning of blade position with the simple turn of the key.	1/Each Sold Individually



Retractors (Bookwalter® Rings)

Bookwalter® Elliptical Ring

For Obese Patients



CODE	DESCRIPTION	LENGTH
50-4595	Segmented	14 ½ x 15 in 368 x 381 mm

Bookwalter® Oval Ring

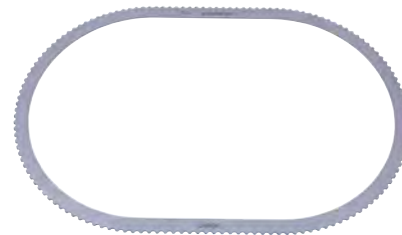

CODE	DESCRIPTION	DIMENSIONS
50-4556	Large	12 x 18 ½ in 305 x 470 mm

Bookwalter® Round Ring



CODE	DESCRIPTION	LENGTH
50-4633	Large, with Suture Slots	16 in 406 mm

Retractors (Bookwalter® Rings)



Bookwalter® Segmented Ring

CODE	DESCRIPTION	DIMENSIONS
50-4588	Large, Consists of One 12½ in Round Ring and Two 6 in Straight Segments	12½ x 19½ in 318 x 495 mm

OBESE PATIENT



50-4587

Bookwalter® Segmented Ring

Straight Ring Segment, Pair

CODE	LENGTH
50-4636	4 in 102 mm
50-4637	6 in 152 mm
50-4638	8 in 203 mm

Retractors (Bookwalter® Couplings)



Bookwalter® Lightweight Post Coupling

CODE	DESCRIPTION	WIDTH
50-4554	Coupler	1 x 4 in 25 x 102 mm

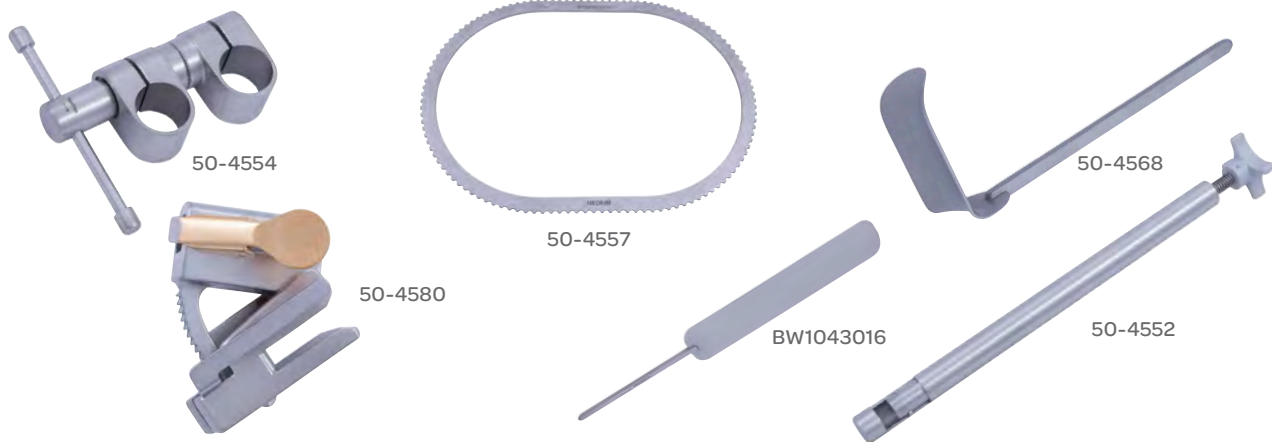

Bookwalter® Obese Patient Retractor System, 18 in (458 mm) Table Post

CODE	DESCRIPTION	LENGTH	QTY
BW1046BKIT	Includes Part Numbers Listed Below:		
BW0144005	18 in Table Post Obese Patients	1 x 1 in 25 x 25 mm	1
50-4554	Post Coupling		1
50-4552	Retractor Horizontal Bar		1
50-4557	Retractor, Oval Ring Medium		1
50-4580	Tilt Ratchets		6
BW0338014	Ratchet Extender		1
BW0338015	Twister Ratchet		1
BW1271017	Balfour Blade	3 ½ x 2 ¾ in 89 x 70 mm	1
BW1045176	Harrington Blade	3 ½ x 10 in 89 x 254 mm	1
50-4568	Kelly Retractor Blades	2 x 3 in 51 x 76 mm	1
50-4569	Kelly Retractor Blades	2 x 4 in 51 x 102 mm	1
BW1045000	Kelly Blade	2 x 8 in 51 x 203 mm	1
BW1043016	Malleable Blade	2 x 10 in 51 x 254 mm	1
BW1043029	Malleable Blade	3 x 10 in 76 x 254 mm	1
BW1045069	Malleable Blade	4 x 8 in 102 x 203 mm	1

Retractors (Bookwalter® Sets)



BW1046BRT

Bookwalter® Obese Patient Accessory Kit, 18 in (458 mm) Table Post

CODE	DESCRIPTION	LENGTH	QTY
BW1046BRT	Includes Part Numbers Listed Below:		
BW0144005	18 in Table Post Obese Patients		1
BW0338014	Ratchet Extender		1
BW0338015	Twister Ratchet		1
BW1271017	Balfour Blade	3½ x 2¾ in 89 x 70 mm	1
BW1045176	Harrington Blade	3½ x 10 in 89 x 254 mm	1
BW1045000	Kelly Blade	2 x 8 in 51 x 203 mm	1
BW1043016	Malleable Blade	2 x 10 in 51 x 254 mm	1
BW1043029	Malleable Blade	3 x 10 in 76 x 254 mm	1
BW1045069	Malleable Blade	4 x 8 in 102 x 203 mm	1



BW1045BRT

Bookwalter® Obese Patient Accessory Kit, 24 in (610 mm) Table Post

CODE	DESCRIPTION	LENGTH	QTY
BW1045BRT	Includes Part Numbers Listed Below:		
BW0144003	24 in Table Post		1
BW0338014	Ratchet Extender		1
BW0338015	Twister Ratchet		1
BW1271017	Balfour Blade	3½ x 2¾ in 89 x 70 mm	1
BW1045176	Harrington Blade	3½ x 10 in 89 x 254 mm	1
BW1045000	Kelly Blade	2 x 8 in 51 x 203 mm	1
BW1043016	Malleable Blade	2 x 10 in 51 x 254 mm	1
BW1043029	Malleable Blade	3 x 10 in 76 x 254 mm	1
BW1045069	Malleable Blade	4 x 10 in 102 x 203 mm	1

Retractors (Bookwalter® Sets)



BW1045BKIT

Bookwalter® Obese Patient Retractor System, 24 in (610 mm) Table Post

CODE	DESCRIPTION	LENGTH	QTY
BW1045BKIT	Includes Part Numbers Listed Below:		
BW0144003	Table Post		1
BW1043016	Malleable Blade	2 x 10 in 51 x 254 mm	1
BW1043029	Malleable Blade	3 x 10 in 76 x 254 mm	1
BW1045069	Malleable Blade	4 x 8 in 102 x 203 mm	1
BW1271017	Balfour Blade	3½ x 2¾ in 89 x 70 mm	1
BW1045176	Harrington Blade	3½ x 10 in 89 x 254 mm	1
BW0338014	Ratchet Extender		1
BW0338015	Twister Ratchet		1
50-4552	Horizontal Bar		1
50-4554	Post Coupling	1 x 1 in 25 x 25 mm	1
50-4557	Medium Oval Ring		1
50-4568	Kelly Blade	2 x 3 in 51 x 76 mm	1
50-4569	Kelly Blade	2 x 4 in 51 x 102 mm	1
BW1045000	Kelly Blade	2 x 8 in 51 x 203 mm	1
50-4580	Tilt Rachets		6

Retractors (Bookwalter® Systems)

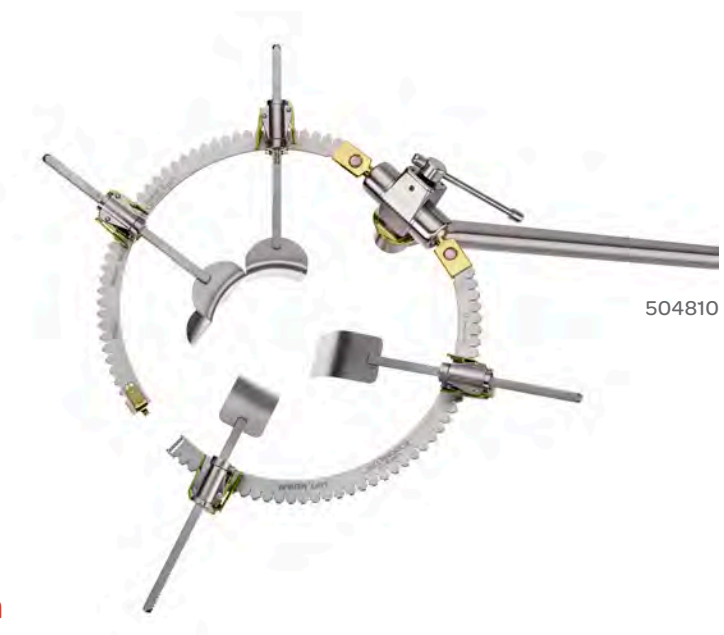

Bookwalter® Adaptable Ring System

CODE	DESCRIPTION
50-4810	System includes the Horizontal Bar and dual ball joint hinge system as well as the Small Round, Medium Round, and Medium Oval Ring Segments
50-4811	Small, Round Ring Segments
50-4812	Medium, Round Ring Segments
50-4813	Medium, Oval Ring Segments



Bookwalter® Adaptable Ring System Bridge

CODE	DESCRIPTION
50-4687	For use with 50-4810

Retractors (Bookwalter® Table Posts)



BW014403

Bookwalter® Table Post

CODE	DESCRIPTION	LENGTH
BW0144005	18 in	18 in 460 mm
BW0144003	24 in	24 in 601 mm



504688

Bookwalter® Lightweight Table Post

CODE	DESCRIPTION	LENGTH
504688	Lightweight Table Post	12 in 305 mm
504697	Lightweight Table Post	16 in 406 mm

Retractors (Laminectomy)



50-1160

Beckman-Adson Laminectomy Retractor

Self-Retaining with Hinged Arms

CODE	DESCRIPTION	TOTAL OPENING		BLADE		LENGTH	
50-1160	Blunt, Four Prong	5 in	127 mm	1 x 1¼ in	25 x 32 mm	12 in	305 mm
50-1161	Sharp, Four Prong	5 in	127 mm	1 x 1 in	25 x 25 mm	12 in	305 mm
50-1162	X-Long, Four Prong,	5½ in	140 mm	1 x 1¾ in	25 x 44 mm	12 in	305 mm
50-1163	Seven Prong	5½ in	140 mm	1¾ x 1⅞	44 x 78 mm	12¾ in	324 mm



50-1066

Meyering Laminectomy Retractor

CODE	DESCRIPTION	BLADE		LENGTH	
50-1066	Medium	1 x 3 in	25 x 76 mm	9½ in	241 mm
50-1067	Large	2 x 3½ in	51 x 89 mm	9½ in	241 mm

Retractors (Rectal)



Sawyer Rectal Retractor

CODE	BLADE
50-5671	1⅞ x 3⅞ in 29 x 79 mm

Retractors (Thyroid)



Beckman Retractor

Self-Retaining with Hinged Arms

CODE	DESCRIPTION	BLADE	TOTAL OPENING	LENGTH
50-1165	Sharp, Four Prong	¾ x 1 in	5½ in 140 mm	12 in 305 mm

Retractors (Abdominal)



Harrington Splanchnic Retractor

CODE	BLADE	LENGTH
50-8102	2½ in 64 mm	12½ in 64 mm

Retractors (Obstetric)



Delee Universal Retractor

CODE	BLADE
50-5575	2¾ x 2 in 70 x 51 mm

Retractors (Vaginal)

Heaney-Simon Vaginal Retractor



CODE	BLADE	LENGTH
50-5570	1 x 4 1/2 in 25 x 114 mm	11 in 279 mm

Retractors (Vein)

Cushing Vein Retractor



CODE	DESCRIPTION	LENGTH
20-1728	8 mm Wide	9 1/2 in 240 mm

Rongeurs

Cloward Opti-Length® Rongeur

CODE	DESCRIPTION	LENGTH
67-7324	6 x 10 Cup	11 in 279 mm



Rongeurs

Stille-Luer Rongeur

Angular, 5 mm Bite

CODE	DESCRIPTION	LENGTH
53-1133		9½ in 241 mm
53-1118	Flat Lower Jaw	9½ in 241 mm



Rongeurs (Laminectomy)

Fulton Laminectomy Rongeur

15 x 16 Cup, Narrow Blade

CODE	DESCRIPTION	LENGTH
53-1066	Straight, Double-Action	9½ in 241 mm

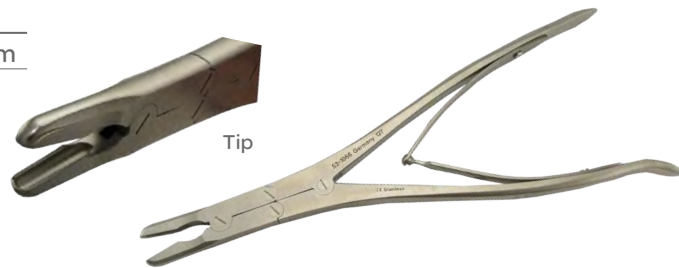

Rongeurs (IVD)

Love-Gruenwald Opti-Length® Rongeur, IVD

3 x 10 Cup

CODE	DESCRIPTION	LENGTH
67-7319	Straight	11 in 279 mm
67-7320	30° Up	11 in 279 mm

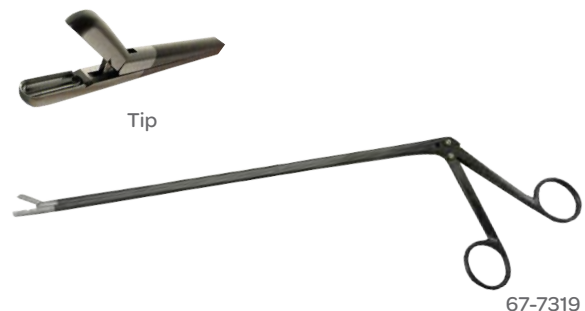

Rongeurs (IVD)

Spurling Opti-Length® Rongeur, LVD

4 x 10 Cup

CODE	DESCRIPTION	LENGTH
67-7321	Straight	11 in 279 mm
67-7322	Up Biting	11 in 279 mm



67-7321

Rongeurs (Lumbar)

Kerrison Lumbar Rongeur

CODE	DESCRIPTION	BITE	LENGTH
53-1426	40° Angle Up, Hardy™ Style Handle with Ball Spring	3 mm	11 in 279 mm
53-1428	40° Angle Up, Hardy™ Style Handle with Ball Spring	5 mm	11 in 279 mm
53-1429	40° Angle Up, Hardy™ Style Handle with Ball Spring	6 mm	11 in 279 mm
67-7325	40° Angle Up	1 mm	15 in 380 mm
67-7326	40° Angle Up	2 mm	15 in 380 mm
67-7327	40° Angle Up	3 mm	15 in 380 mm
67-7328	40° Angle Up	4 mm	15 in 380 mm
67-7329	40° Angle Up	5 mm	15 in 380 mm
67-7330	90° Up	1 mm	15 in 380 mm
67-7331	90° Up	2 mm	15 in 380 mm
67-7332	90° Up	3 mm	15 in 380 mm
67-7333	90° Up	4 mm	15 in 380 mm
67-7334	90° Up	5 mm	15 in 380 mm
677282	40° Up, Hardy™ Style Handle	2 mm	12 in 305 mm
677285	40° Up, Hardy™ Style Handle	3 mm	12 in 305 mm
677288	40° Up, Hardy™ Style Handle	4 mm	12 in 305 mm

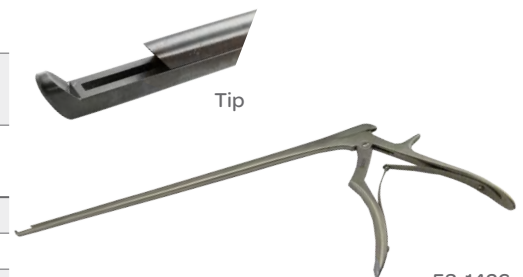

53-1426

Rongeurs (Rib)

Dale First Rib Rongeur

Double-Action

CODE	BITE	LENGTH
56-8040	1/8 in 3 mm	14 1/2 in 368 mm



Ferris-Smith Rongeur

CODE	DESCRIPTION	JAW SIZE	LENGTH
677323	Straight	3 x 10 mm	11 x 280 mm
677324	Straight	6 x 10 mm	11 x 280 mm



Rongeurs (IVD)

IVD Rongeur

CODE	DESCRIPTION	JAW SIZE	LENGTH
67-7319	Straight	3 x 10 mm	11 in 280 mm
67-7321	Straight	4 x 10 mm	11 in 280 mm
67-7320	30° Up Bite	3 x 10 mm	11 in 280 mm
67-7322	30° Up Bite	4 x 10 mm	11 in 280 mm



Rongeurs (Kerrison)

Microsect® Shaver

45° Up Bite

CODE	TIP WIDTH	LENGTH
677314	1.5 mm	12 in 305 mm
677315	2 mm	12 in 305 mm
677316	2.5 mm	12 in 305 mm
677317	3 mm	12 in 305 mm
677318	4 mm	12 in 305 mm

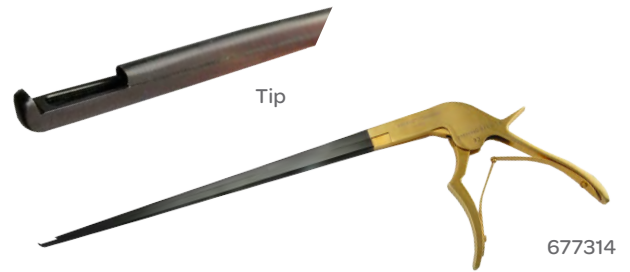

Stille-Luer

Double-Action

CODE	DESCRIPTION	LENGTH
67-7240	Straight, 10 mm Jaw	11 in 280 mm
67-7242	Straight, 10 mm Jaw	13 in 330 mm
67-7239	Angled, 5 mm Jaw	11 in 280 mm
67-7241	Angled, 5 mm Jaw	13 in 330 mm



Scissors

DeBakey-Metzenbaum Scissors

Fine Tungsten Carbide Edges

CODE	DESCRIPTION	LENGTH
32-3576	Straight	12 ¼ in 311 mm



Scissors

Diethrich Valve Scissors

Classic Plus®, Stellite Inserts, Serrated Blade

CODE	DESCRIPTION	LENGTH
67-7665	Full Curved, 4 mm	12 in 305 mm



Doyen Scissors

Classic Plus®, Stellite Inserts, Beveled

CODE	DESCRIPTION	LENGTH
67-7663	Blunt	8 mm 280 mm
67-7664	Curved, Blunt	8 mm 280 mm



677663

Leksell Rongeur

Double-Action, Curved

CODE	DESCRIPTION	LENGTH
67-7900	1 mm	14 mm 356 mm
67-7901	2 mm	14 mm 356 mm
67-7902	3 mm	14 mm 356 mm
67-7903	4 mm	14 mm 356 mm
67-7904	5 mm	14 mm 356 mm
67-7905	6 mm	14 mm 356 mm



67-7905

Scissors

Leksell Rongeur

Double-Action, Full Curve

CODE	DESCRIPTION	LENGTH
67-7912	1 mm	14 in 356 mm
67-7913	2 mm	14 in 356 mm
67-7914	3 mm	14 in 356 mm
67-7915	4 mm	14 in 356 mm
67-7916	5 mm	14 in 356 mm
67-7917	6 mm	14 in 356 mm



Leksell Rongeur

Double-Action, Curve

CODE	DESCRIPTION	LENGTH
67-7906	1 mm	14 in 356 mm
67-7907	2 mm	14 in 356 mm
67-7908	3 mm	14 in 356 mm
67-7909	4 mm	14 in 356 mm
67-7910	5 mm	14 in 356 mm
67-7911	6 mm	14 in 356 mm

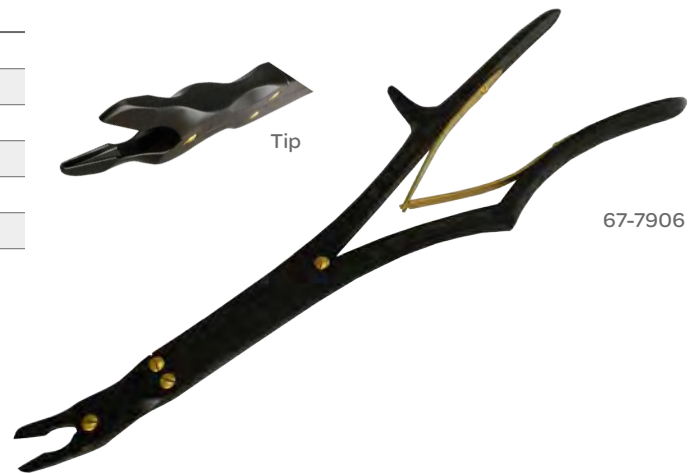

Leksell Rongeur

Double-Action, Full Curve

CODE	DESCRIPTION	LENGTH
67-7918	1 mm	14 in 356 mm
67-7919	2 mm	14 in 356 mm
67-7920	3 mm	14 in 356 mm
67-7921	4 mm	14 in 356 mm
67-7922	5 mm	14 in 356 mm
67-7923	6 mm	14 in 356 mm



Scissors

Mayo Scissors

Beveled Blades

CODE	DESCRIPTION	LENGTH
03-5131	Straight	12 in 305 mm
32-3592	Straight	14 in 356 mm
03-5040	Straight	16 in 405 mm
03-5045	Straight	18 in 455 mm
03-5132	Curved	12 in 305 mm
32-3593	Curved	14 in 356 mm
03-5130	Curved	14½ in 359 mm
03-5145	Curved	18 in 455 mm



32-3592

Mayo Scissors

Classic Plus®, Stellite Inserts, Beveled, Standard, Curved

CODE	DESCRIPTION	LENGTH
677637	Blunt, 4 mm	14 in 356 mm



Mayo-Harrington Scissors

CODE	DESCRIPTION	LENGTH
32-3592	Straight	14 in 356 mm
32-3593	Curved	14 in 356 mm



32-3593

Scissors

Metzenbaum Scissors

CODE	DESCRIPTION	LENGTH
32-794	Straight, Fine Tungsten Carbide	12 in 305 mm
32-793	Curved, Delicate	10 in 254 mm
32-3594	Curved	12¼ in 311 mm
32-3596	Curved, Super Cuts	13⅞ in 355 mm



32-3594

Metzenbaum Classic Plus® Dissecting Scissors

Stellite Inserts

CODE	DESCRIPTION	LENGTH
677643	Curved, Blunt/Blunt	11 in 279 mm
677644	Curved, Blunt/Blunt	13 in 330 mm
677645	Curved, Blunt/Blunt	15 in 381 mm
677648	Curved, Blunt/Blunt, Delicate	11 in 279 mm
677646	Curved, Blunt/Blunt, Delicate	14 in 356 mm
677647	Curved, Blunt/Blunt, Super Delicate	14 in 356 mm
677640	Curved, Sharp/Sharp	11 in 279 mm
677641	Curved, Sharp/Sharp	13 in 330 mm
677642	Curved, Sharp/Sharp	15 in 355 mm



677643

Nelson Classic Plus® Scissors

Stellite Edge Inserts

CODE	DESCRIPTION	LENGTH
36-5070	Curved, Standard	11 in 279 mm



Scissors

Nelson-Metzenbaum Scissors

Curved, Regular Tips, Fine Tungsten Carbide Inserts

CODE	DESCRIPTION	LENGTH
32-880		11 in 279 mm
32-881	Delicate Tip	11 in 279 mm
32-882		12 in 305 mm
32-799		14 in 356 mm
32-899		16 in 406 mm
32-999		18 in 457 mm



32-881

Zep Scissors

Fine Tungsten Carbide Blades

CODE	DESCRIPTION	LENGTH
32-892	Curved	10 ½ in 265 mm
32-895	Curved	12 in 305 mm
32-893	Full Curve	10 ½ in 265 mm
32-896	Full Curve	12 in 305 mm
32-898	Full Curve	14 in 356 mm
32-891	Slight Curve	10 ½ in 265 mm



32-892

Mayo-Harrington Dissecting Scissors

Slender Pattern

CODE	DESCRIPTION	LENGTH
03-5226	Straight	11 ¾ in 298 mm
03-5326	Curved	11 ½ in 290 mm
03-5330	Curved	14 in 350 mm



03-5330

Metzenbaum Dissecting Scissors

CODE	DESCRIPTION	LENGTH
54-1037	Curved	10 in 254 mm



Scissors (Dissecting)

Nelson-Metzenbaum Dissecting Scissors

Standard Pattern

CODE	DESCRIPTION	LENGTH
04-3226	Straight	10 ¼ in 260 mm
04-3230	Straight	11 ¾ in 300 mm
04-3232	Straight	14 ½ in 368 mm
04-3245	Straight	18 in 455 mm
04-3326	Curved	10 ¼ in 260 mm
04-3330	Curved	12 in 305 mm
04-3338	Curved	12 in 305 mm
04-3332	Curved	14 in 356 mm
04-3340	Curved	16 in 405 mm
04-3345	Curved	18 in 455 mm

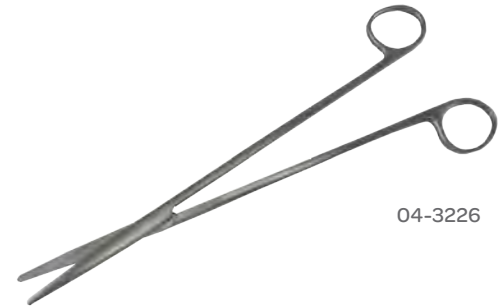

Scissors (Valve)

Litwak Mitral Valve Scissors

CODE	DESCRIPTION	LENGTH
54-8023	Angled on Side	11 in 279 mm



Shears (Rib)

Coryllos Rib Shears

CODE	DESCRIPTION	LENGTH
56-8055	Left	14 in 356 mm
56-8056	Right	14 in 356 mm



Shears (Rib)

Coryllos Rib Shears

CODE	DESCRIPTION	LENGTH
56-8055	Left	14 in 356 mm
56-8056	Right	14 in 356 mm



Sauerbruch Rib Shears

CODE	DESCRIPTION	LENGTH
56-8051		10 ½ in 267 mm



Stille Giertz Rib Shears

CODE	DESCRIPTION	LENGTH
56-8044		10 in 254 mm



Spatulas (Elevator)



Woodson Elevator Spatula

CODE	DESCRIPTION	BLADE	LENGTH
59-1000	Double-Ended, Semi-Sharp	1/8 x 1 1/2 in 3 x 13 mm	1/8 x 1/2 x 10 in 3 x 13 x 254 mm

Spreaders (Lamina)



Lamina Spreader

CODE	DESCRIPTION	JAW OPENING	LENGTH
61-2525		2 in 51 mm	9½ in 241 mm

Suction Tubes



70-6560

Andrews-Pynchon Suction Tube

CODE	DESCRIPTION	LENGTH
70-6560	Stainless Steel	9½ in 241 mm
67-7675	Stainless Steel, 6 mm	11 in 280 mm



70-4002

Poole Suction Tube

Straight Tubing Connection

CODE	DESCRIPTION	LENGTH
70-4001		30 French x 9 5/8 in 30 French x 244 mm
70-4002	With Finger Cut-Off	30 French x 10 1/4 in 30 French x 260 mm

Suction Tubes



70-1161

Sachs Suction Tube

CODE	DESCRIPTION	SHAFT	LENGTH
70-1160	Small	9 ⁵ / ₈ in 241 mm	8 French x 4 in 8 French x 102 mm
70-1161	Large	9 ⁵ / ₈ in 241 mm	15 French x 4 1/2 in 15 French x 114 mm



32-3360

Suction Tube

CODE	DESCRIPTION	WORKING DISTANCE	LENGTH
32-3360		9 1/2 in 241 mm	12 in 305 mm
32-3361		13 1/8 in 323 mm	15 in 380 mm



32-3362

Yankauer Suction Tube

CODE	DESCRIPTION	WORKING DISTANCE	LENGTH
70-4026	Removable Tip, Standard		10 ³ / ₈ in 264 mm
70-4024	with Thumb Control		11 ¹ / ₄ in 254 mm
32-3362	with Thumb Control	5 ⁷ / ₈ x 12 ³ / ₄ in 148 x 325 mm	12 ³ / ₄ in 325 mm
09-8600			14 in 355 mm

Suction Tubes



Cooley Opti-Length® Left Ventricular Sump

CODE	DESCRIPTION	TIP WIDTH	LENGTH
67-7677	45°, Perforated	5/16 in	19 3/4 in 502 mm

Suction Tubes (Tube)



Andrews-Pynchon Opti-Length® Suction Tube

CODE	LENGTH
67-7675	11 in 279 mm

Suction Tubes (Vascular)



Methodist Vascular Suction Tube

CODE	LENGTH
70-8040	3/8 x 10 in 10 x 254 mm

OBESE PATIENT



Scan the code above to learn more about our OB/GYN portfolio.

OB/GYN Portfolio



OB/GYN

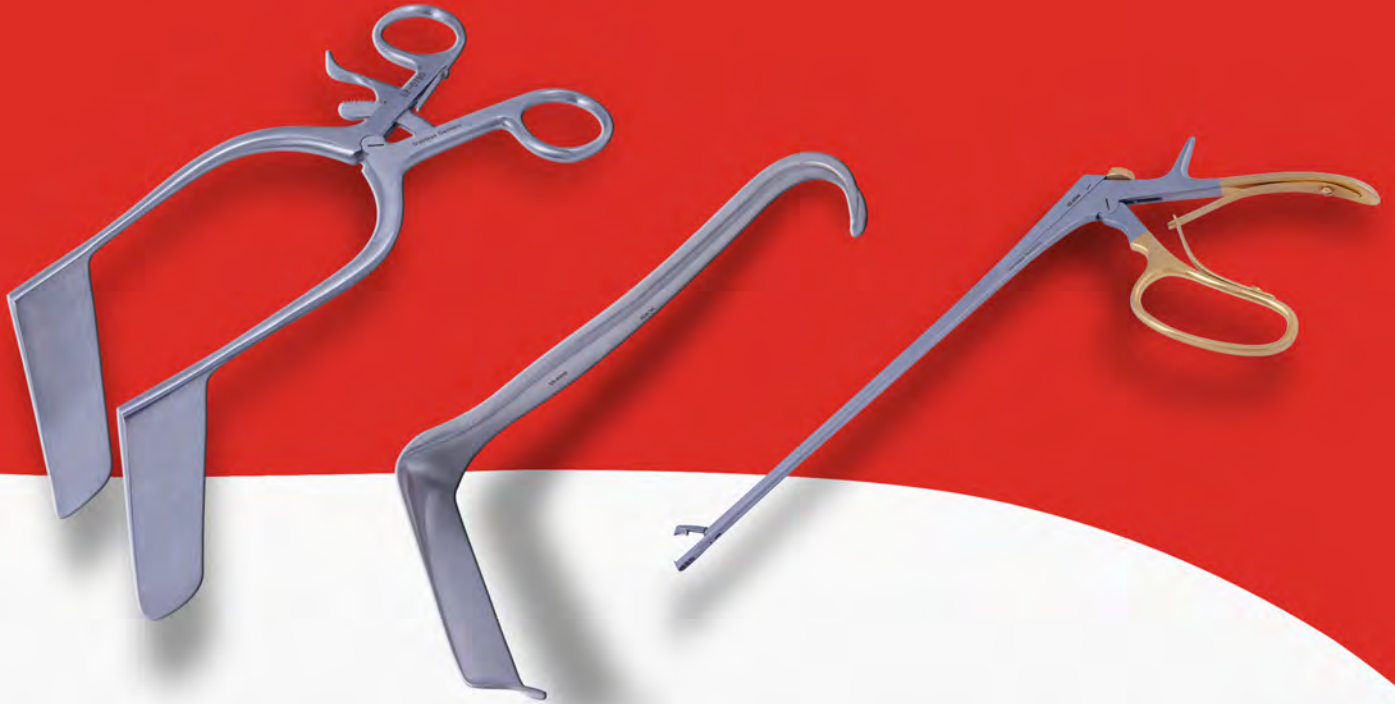

Clamps	OBGYN-2
Curettes	OBGYN-5
Cutters	OBGYN-9
Dilators	OBGYN-9
Extractors	OBGYN-13
Forceps	OBGYN-13
Hooks	OBGYN-27
Laparoscopic	OBGYN-28
Manipulators	OBGYN-29
Needle Holders	OBGYN-30

Probes	OBGYN-31
Punches	OBGYN-32
Retractors	OBGYN-33
Rulers	OBGYN-42
Scissors	OBGYN-42
Sounds	OBGYN-45
Speculums	OBGYN-45
Spoons	OBGYN-53
Tenaculums	OBGYN-53

Questions? Contact us at customerservice@symmetrysurgical.com or learn more at symmetrysurgical.com

The Surgical Instrument Desk Reference

How to Use Our Catalog

The Symmetry Surgical catalog is designed with you in mind, to be your trusted resource for surgical instrumentation. We took great care in creating an easy-to-use, robust catalog and we think you'll be pleased with the design as you become more familiar with our broad portfolio.

Layout

The catalog is organized by surgical specialty *and* product function.

And we know that it is difficult to pick up an instrument and know what specialty it's listed in. To make your job easier, we've sorted the instruments in our portfolio by surgical function, too, including Energy, Laparoscopic, Retractors and Sterilization Solutions.

U.S. Customer Service

Your Symmetry Surgical Customer Service team wants to make ordering surgical instruments the easiest part of your day. We accept orders via phone, fax, email, our website, Global Healthcare Exchange (GHX) and through the mail.

PHONE

800.251.3000

(Available Monday through Friday, 8:30 AM–6:30 PM EST)

FAX

800.342.3272

EMAIL

customerservice@symmetrysurgical.com

ONLINE

symmetrysurgical.com

MAILING ADDRESS

Symmetry Surgical
Attn: Customer Service
3034 Owen Drive
Antioch, TN 37013

The Surgical Instrument Desk Reference

International Customer Service

PHONE

Symmetry Surgical Switzerland GmbH
+41 (0) 52 557 59 00
(Available Monday through Friday, 7:00-16:00 GMT)

Symmetry Surgical, Inc., USA
615.964.5672
(Available Monday through Friday, 8:30 AM-6:30 PM EST)

FAX

Symmetry Surgical Switzerland GmbH
+41 (0) 52 557 59 99

EMAIL

customerservice@symmetrysurgical.com
internationalorders@symmetrysurgical.com

ONLINE

symmetrysurgical.com

MAILING ADDRESS

Symmetry Surgical Switzerland GmbH
Bühlstrasse 27
CH-8200 Schaffhausen
Switzerland

Symmetry Surgical, Inc.
3034 Owen Drive
Antioch, TN 37013

INTERNATIONAL PAYMENT TERMS/RETURN GOODS POLICY/INSTRUMENT REPAIR & RESTORE PROGRAM/LITERATURE REQUESTS

Please contact your local distributor. Locate a local distributor contact, International Customer Service at +41 (0) 52 557 59 00 or 615.964.5672 (US).

Cardiovascular/Thoracic

Energy

Ear, Nose & Throat

General

Laparoscopic

Neurology

Obesity

OB/GYN

Ophthalmology

Orthopedics & Arthroscopy

Pediatrics

Rectal

Retractors

Spine

Urology

Sterilization Solutions

Alphabetical & Numeric Indexes

OB/GYN

Clamps

M.D. Anderson Clamp

Slender Atraumatic Jaws with Longitudinal Serrations

CODE	DESCRIPTION	LENGTH
52-8990	Curved, Long	10 in 250 mm
52-8991	Curved, Long	11 in 280 mm
52-8992	Curved, Long	14 in 355 mm

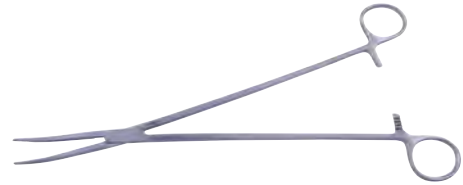

52-8991

Clamps (Uterine)

Adair Uterine Tenaculum Clamp

CODE	DESCRIPTION	LENGTH
19-4004	Uterine Clamp	7¾ in 197 mm



Clamps (Cesarean Section)

C-Assist Uterine Compression Clamp

CODE	DESCRIPTION
52-1400	Compression Clamp



C-Assist Uterine Silicone Jaw Inserts

CODE	DESCRIPTION	QTY
52-1510	Sterile	10 Pairs / Box



Clamps (Cesarean Section)

C-Assist Compression Belt

CODE	DESCRIPTION	QTY
52-1410	Sterile	10/Box
52-1475	Sterile	1/Box



Clamps (Circumcision)

Circumcision Clamp

CODE	DIAMETER
51-9911	11 mm
51-9913	13 mm
51-9914	14.5 mm
51-9916	16 mm
51-9921	21 mm
51-9926	26 mm
51-9932	32 mm



51-9911

Circumcision Bell

CODE	DESCRIPTION
51-9911B	Replacement for 51-9911
51-9913B	Replacement for 51-9913
51-9914B	Replacement for 51-9914
51-9916B	Replacement for 51-9916
51-9921B	Replacement for 51-9921
51-9926B	Replacement for 51-9926
51-9929B	Replacement for 51-9929
51-9932B	Replacement for 51-9932
51-9935B	Replacement for 51-9935



51-9913B

Circumcision Clamp Screw

CODE	DESCRIPTION
02-90-10020	For All Sizes



Clamps (Circumcision)

Nut for Circumcision Clamp

CODE	DESCRIPTION
51-9910	Circumcision Instrument

Mogen Circumcision Clamp

CODE	DESCRIPTION
85-6550	Circumcision Clamp



Clamps

Clark Clamp

Longitudinal Serrated Jaws

CODE	DESCRIPTION	LENGTH
52-5528	Clamp	8¾ in 220 mm
52-5529	Clamp	12 in 305 mm

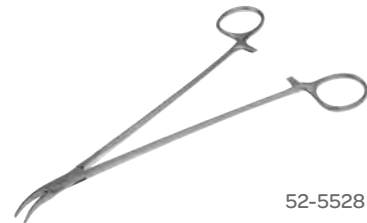

52-5528

Clamps (Pelvic)

Masterson Pelvic Clamp

CODE	DESCRIPTION	JAW LENGTH	LENGTH
37-1522	Straight	1¾ in 45 mm	10½ in 267 mm
37-1523	Curved	1¾ in 45 mm	10½ in 267 mm

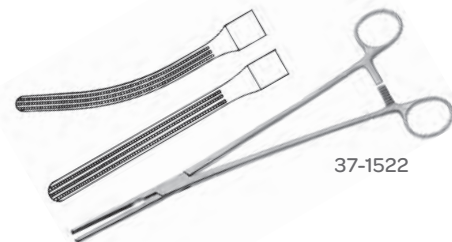

37-1522

Curettes (Biopsy)

Duncan Biopsy Curette

CODE	DESCRIPTION	LENGTH
23-5599	Biopsy Curette, Cup Size 3 x 12 mm	11 ½ in 292 mm

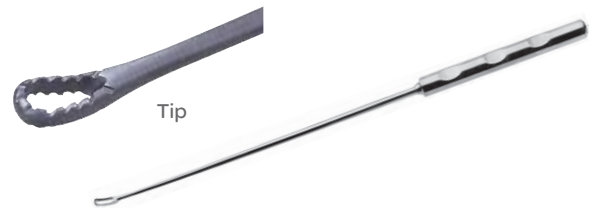

Curettes (Endocervical)

Kelly-Gray Endocervical and Endometrial Biopsy Curette

Malleable Shaft, Working Edges Serrated on Both Sides

CODE	TIP WIDTH	LENGTH
52-7071	5 mm Wide	9 ½ in 240 mm
52-7072	6 mm Wide	9 ½ in 240 mm
52-7073	7 mm Wide	9 ½ in 240 mm
52-7074	8 mm Wide	9 ½ in 240 mm

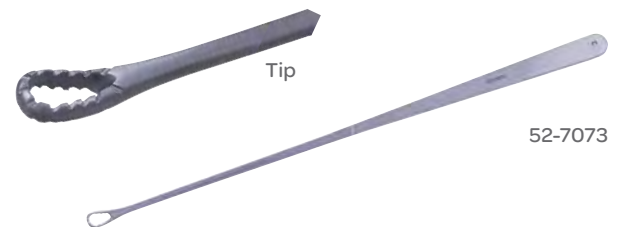

Kevourkian-Younger Endocervical Biopsy Curette

CODE	DESCRIPTION
52-7010	Standard Pattern
52-7015	With Basket

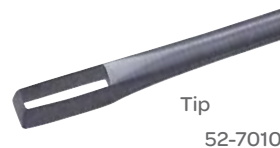

Curettes (Endometrial)

Novak Endometrium Biopsy Suction Curette

With Luer-Lock Hub and Teeth

CODE	DESCRIPTION	LENGTH
52-7050	4 mm Diameter	9 in 230 mm



Curettes (Endometrial)

Randall Endometrium Biopsy Suction Curette

With Luer-Lock Suction

CODE	DESCRIPTION	LENGTH
52-7030	4 mm Diameter	9 in 230 mm

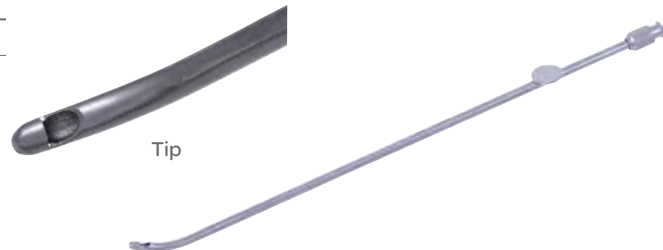

Curettes (Placenta)

Recamier Placenta Curette

Rigid Shaft

CODE	DESCRIPTION	TIP WIDTH	LENGTH
53-7005	Sharp	35 mm	13½ in 342 mm
53-7010	Sharp	40 mm	13½ in 342 mm
53-7025	Blunt	35 mm	13½ in 342 mm
53-7030	Blunt	40 mm	13½ in 342 mm



Curettes (Uterine)

Bumm Uterine Curette

Malleable Shaft

CODE	DESCRIPTION	WIDTH	LENGTH
52-8610	Sharp	10 mm	11 in 280 mm
52-8612	Sharp	13 mm	11 in 280 mm
52-8613	Sharp	15 mm	11 in 280 mm
52-8614	Sharp	17 mm	11 in 280 mm
52-8615	Sharp	19 mm	11 in 280 mm
52-8616	Sharp	21 mm	11 in 280 mm
52-8666	Blunt	12 mm	11 ¹³ / ₁₆ in 300 mm



Curettes (Uterine)

Green Uterine Curette

CODE	WIDTH	LENGTH
52-7552	11 mm	11 in 280 mm
52-7554	12 mm	11 in 280 mm
52-7556	14 mm	11 in 280 mm



Heaney Uterine Curette

CODE	DESCRIPTION	LENGTH
23-5670	Rounded End, Cup Size 3, 12 mm	11½ in 292 mm
52-7080	7.5 mm Wide, with Serrated Edge, Malleable Shaft	9½ in 240 mm



Hunter Uterine Curette

CODE	WIDTH	LENGTH
52-7953	30 mm	8 in 200 mm



Meigs Uterine Curette

Serrated

CODE	DESCRIPTION	LENGTH
23-5608	Cup Size 5 x 10 mm	10 in 254 mm



Curettes (Uterine)

Sims Uterine Curette

One-Piece Construction

CODE	No.	DESCRIPTION	LENGTH
23-5541	1	Sharp	10 in 254 mm
23-5542	2	Sharp	10 in 254 mm
23-5543	3	Sharp	10 in 254 mm
23-5544	4	Sharp	10 ¼ in 260 mm
23-5545	5	Sharp	10 ¼ in 260 mm
23-5546	6	Sharp	10 ¼ in 260 mm



23-5541

Sims Uterine Curette

Malleable Shaft

CODE	No.	DESCRIPTION	LENGTH
23-5532	00	Sharp	11 in 279 mm
23-5533	0	Sharp	11 in 279 mm
23-5534	1	Sharp	11 in 279 mm
23-5535	2	Sharp	11 in 279 mm
23-5536	3	Sharp	11 in 279 mm
23-5537	4	Sharp	11 in 279 mm
23-5538	5	Sharp	11 in 279 mm
23-5539	6	Sharp	11 in 279 mm

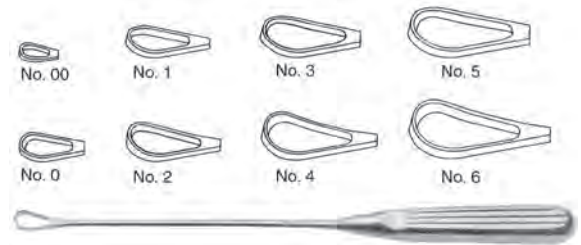

23-5532

Sims Uterine Curette

Malleable Shaft

CODE	No.	DESCRIPTION	LENGTH
52-8149	00	Sharp	11 in 279 mm
52-8150	0	Sharp	11 in 279 mm
52-8151	1	Sharp	11 in 279 mm
52-8152	2	Sharp	11 in 279 mm
52-8153	3	Sharp	11 in 279 mm
52-8154	4	Sharp	11 in 279 mm
52-8155	5	Sharp	11 in 279 mm
52-8156	6	Sharp	11 in 279 mm



52-8150

Curettes (Uterine)

Thomas Uterine Curette

CODE	No.	DESCRIPTION	LENGTH
23-5500	1	Blunt, Malleable Shaft	11 in 279 mm
23-5501	2	Blunt, Malleable Shaft	11 in 279 mm
23-5502	3	Blunt, Malleable Shaft	11 in 279 mm
23-5503	4	Blunt, Malleable Shaft	11 in 279 mm
23-5504	5	Blunt, Malleable Shaft	11 in 279 mm
23-5505	6	Blunt, Malleable Shaft	11 in 279 mm
52-7501	1	Blunt, Malleable Shaft	12 in 304 mm
52-7502	2	Blunt, Malleable Shaft	12 in 304 mm
52-7503	3	Blunt, Malleable Shaft	12 in 304 mm
52-7504	4	Blunt, Malleable Shaft	12 in 304 mm
52-7505	5	Blunt, Malleable Shaft	12 in 304 mm
52-7506	6	Blunt, Malleable Shaft	12 in 304 mm

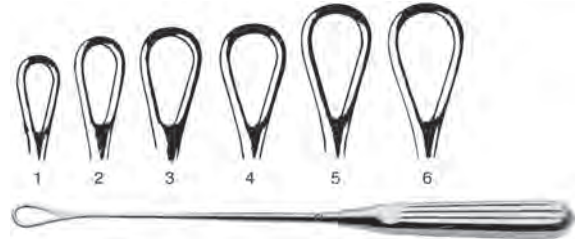

Cutters (Umbilical Cord)

Umbilical Cord Clamp Cutter

Serrated Jaw

CODE	DESCRIPTION	LENGTH
53-2312	Cord Clamp Cutter	4 3/4 in 120 mm



Dilators (Uterine)

Hank Uterine Dilator

Double-Ended

CODE	DESCRIPTION	LENGTH
52-3707	7/8 French	10 3/4 in 270 mm
52-3709	9/10 French	10 3/4 in 270 mm
52-3711	11/12 French	10 3/4 in 270 mm
52-3713	13/14 French	10 3/4 in 270 mm
52-3715	15/16 French	10 3/4 in 270 mm
52-3717	17/18 French	10 3/4 in 270 mm
52-3719	19/20 French	10 3/4 in 270 mm
52-3721	21/22 French	10 3/4 in 270 mm
52-3723	23/24 French	10 3/4 in 270 mm
52-3725	25/26 French	10 3/4 in 270 mm
52-3727	27/28 French	10 3/4 in 270 mm
52-3729	29/30 French	10 3/4 in 270 mm



Dilators (Uterine)

Hank Uterine Dilator

Double-Ended

CODE	DESCRIPTION	LENGTH
52-3707	7/8 French	10 ³ / ₄ in 270 mm
52-3709	9/10 French	10 ³ / ₄ in 270 mm
52-3711	11/12 French	10 ³ / ₄ in 270 mm
52-3713	13/14 French	10 ³ / ₄ in 270 mm
52-3715	15/16 French	10 ³ / ₄ in 270 mm
52-3717	17/18 French	10 ³ / ₄ in 270 mm
52-3719	19/20 French	10 ³ / ₄ in 270 mm
52-3721	21/22 French	10 ³ / ₄ in 270 mm
52-3723	23/24 French	10 ³ / ₄ in 270 mm
52-3725	25/26 French	10 ³ / ₄ in 270 mm
52-3727	27/28 French	10 ³ / ₄ in 270 mm
52-3729	29/30 French	10 ³ / ₄ in 270 mm
52-3742	Set of Six, In Canvas Roll, 9/10 French to 19/20 French	10 ³ / ₄ in 270 mm

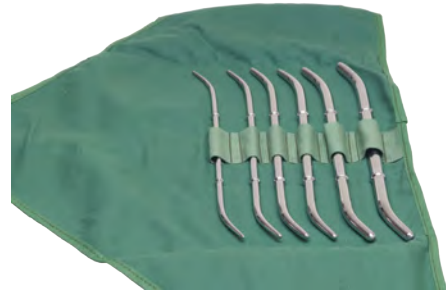

Hegar Uterine Dilator

Double-Ended

CODE	TIP WIDTH	LENGTH
25-5525	1/2 mm	8 in 203 mm
25-5526	3/4 mm	8 in 203 mm
25-5527	5/6 mm	8 in 203 mm
25-5528	7/8 mm	8 in 203 mm
25-5529	9/10 mm	8 in 203 mm
25-5530	11/12 mm	8 in 203 mm
25-5531	13/14 mm	8 in 203 mm
25-5532	15/16 mm	8 in 203 mm
25-5533	17/18 mm	8 in 203 mm



25-5525

Hegar Uterine Dilator

Single-Ended

CODE	DESCRIPTION	LENGTH
52-3016	16 mm	7 in 178 mm
52-3017	17 mm	7 in 178 mm
52-3019	19 mm	7 in 178 mm
52-3020	20 mm	7 in 178 mm
52-3021	21 mm	7 in 178 mm
52-3022	22 mm	7 in 178 mm
52-3023	23 mm	7 in 178 mm
52-3024	24 mm	7 in 178 mm
52-3025	25 mm	7 in 178 mm
52-3026	26 mm	7 in 178 mm



52-3016

Dilators (Uterine)

Hegar Uterine Dilator

Double-Ended

CODE	DESCRIPTION	LENGTH
52-3501	1/2 mm	8 in 200 mm
52-3503	3/4 mm	8 in 200 mm
52-3505	5/6 mm	8 in 200 mm
52-3507	7/8 mm	8 in 200 mm
52-3509	9/10 mm	8 in 200 mm
52-3511	11/12 mm	8 in 200 mm
52-3513	13/14 mm	8 in 200 mm
52-3515	15/16 mm	8 in 200 mm
52-3517	17/18 mm	8 in 200 mm



52-3507

Hegar Uterine Dilator

Double-Ended

CODE	DESCRIPTION	LENGTH
67-7354	3/4 mm	10 in 254 mm
67-7356	7/8 mm	10 in 254 mm
67-7357	9/10 mm	10 in 254 mm
67-7358	11/12 mm	10 in 254 mm
67-7359	13/14 mm	11 in 279 mm
67-7367	11/12 mm	12 in 305 mm
67-7369	15/16 mm	13 in 330 mm



25-5532

Hegar Uterine Dilator

Set of Eight, In Canvas Roll

CODE	DESCRIPTION	LENGTH
52-3542	3/4 mm to 17/18 mm	8 in 200 mm



Dilators (Uterine)

Pratt Uterine Dilator

Double-Ended

CODE	DESCRIPTION	LENGTH
25-5551	13 - 15 French	11 $\frac{7}{8}$ in 302 mm
25-5552	17 - 19 French	11 $\frac{7}{8}$ in 302 mm
25-5553	21 - 23 French	11 $\frac{7}{8}$ in 302 mm
25-5554	25 - 27 French	11 $\frac{7}{8}$ in 302 mm
25-5555	29 - 31 French	11 $\frac{7}{8}$ in 302 mm
25-5556	33 - 35 French	11 $\frac{7}{8}$ in 302 mm
25-5557	37 - 39 French	11 $\frac{7}{8}$ in 302 mm
25-5558	41 - 43 French	11 $\frac{7}{8}$ in 302 mm
52-3617	17 - 19 French	11 $\frac{7}{8}$ in 302 mm
52-3621	21 - 23 French	11 $\frac{7}{8}$ in 302 mm
52-3625	25 - 27 French	11 $\frac{7}{8}$ in 302 mm
52-3629	29 - 31 French	11 $\frac{7}{8}$ in 302 mm
52-3633	33 - 35 French	11 $\frac{7}{8}$ in 302 mm
52-3637	37 - 39 French	11 $\frac{7}{8}$ in 302 mm
52-3641	41 - 43 French	11 $\frac{7}{8}$ in 302 mm



25-5551

Pratt Uterine Dilator

Double-Ended

CODE	DESCRIPTION	LENGTH
52-3613	13-15 French	11 $\frac{7}{8}$ in 302 mm
52-3617	17 - 19 French	11 $\frac{7}{8}$ in 302 mm
52-3621	21 - 23 French	11 $\frac{7}{8}$ in 302 mm
52-3625	25 - 27 French	11 $\frac{7}{8}$ in 302 mm
52-3629	29 - 31 French	11 $\frac{7}{8}$ in 302 mm
52-3633	33 - 35 French	11 $\frac{7}{8}$ in 302 mm
52-3637	37 - 39 French	11 $\frac{7}{8}$ in 302 mm
52-3641	41 - 43 French	11 $\frac{7}{8}$ in 302 mm
52-3642	Set of 8	11 $\frac{7}{8}$ in 302 mm



Mini Dilator

5 Interchangeable Dilators on a Universal Handle. Dilators Measure from 1 mm to 3 mm in 0.5 mm Increments

CODE	DESCRIPTION
52-3280	OS Finder Set



Extractors (Fetal Head)

Murless Extractor

CODE	DESCRIPTION	LENGTH
80-5550	Murless Fetal Head Extractor	10 ½ in 265 mm



Extractors (IUD)

IUD Extractor

CODE	DESCRIPTION	LENGTH
53-0650	IUD Extractor	10 ½ in 265 mm

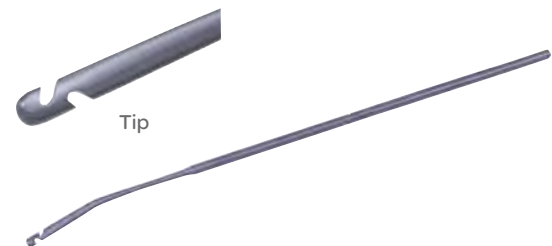

Forceps (Biopsy)

Biopsy Forceps

60° Opening, Oval Cut

CODE	BITE	LENGTH
52-6575	3 x 5 mm	8 in 200 mm

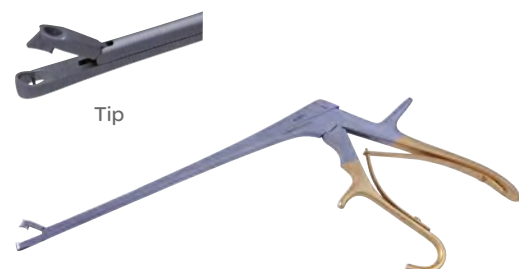

Forceps (Biopsy)

Tischler Cervical Biopsy Forceps

60° Opening

CODE	DESCRIPTION	LENGTH
52-6557	2.3 x 4.2 mm Wide Bite	8 in 200 mm



Forceps (Cervical)

Boston Lying-In Cervical Grasping Forceps

CODE	DESCRIPTION	LENGTH
30-5570	Cervical Grasping Forceps	9½ in 241 mm

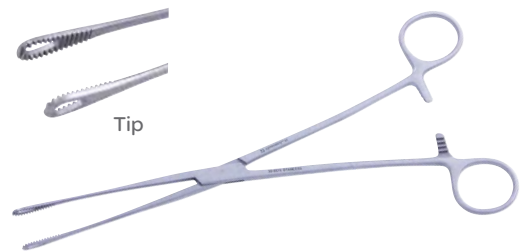

Eppendorfer Cervical Biopsy Forceps

CODE	DESCRIPTION	LENGTH
52-6881	Cervical Biopsy Forceps	8½ in 220 mm

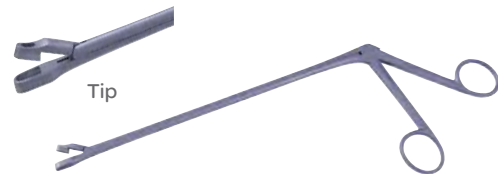

Tischler Cervical Biopsy Forceps

CODE	TIP WIDTH	LENGTH
52-6553	3 mm	8 in 200 mm
52-6555	5 mm	9 in 230 mm



52-6555

Forceps (Deep)

Meeker Deep Surgery Forceps

CODE	DESCRIPTION	LENGTH
30-4701	Right Angle	10 3/4 in 273 mm

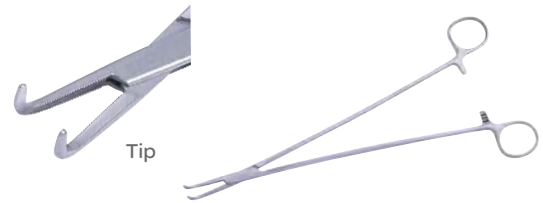

Forceps (Hysterectomy)

Ballentine Hysterectomy Forceps

CODE	DESCRIPTION	LENGTH
52-5511	Curved with Long Serrations	8 1/4 in 210 mm

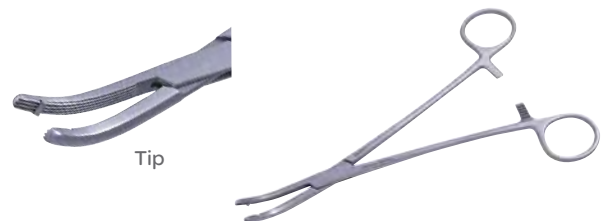

Ballentine Hysterectomy Forceps

Straight

CODE	DESCRIPTION	JAW LENGTH	LENGTH
30-5801	Single Tooth	1 3/4 in 44 mm	8 1/4 in 210 mm
52-5510	Long Serrations		8 1/4 in 210 mm

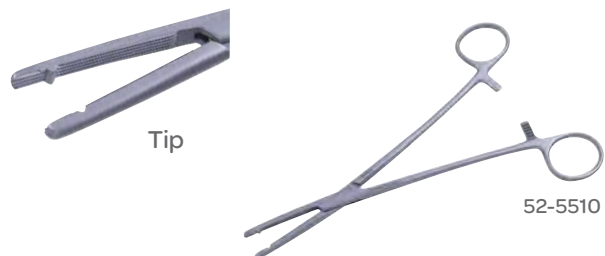

Glenner Hysterectomy Forceps

Curved Left, Single Tooth, Jaws Curved Up and to the Side, with Longitudinal Serrations

CODE	DESCRIPTION	LENGTH
52-5571	Hysterectomy Forceps	8 1/4 in 210 mm



Forceps (Hysterectomy)

Heaney Hysterectomy Forceps

CODE	DESCRIPTION	LENGTH
52-5500	Double Tooth	9 ³ / ₄ in 245 mm



Heaney Hysterectomy Forceps

Curved, Single Tooth

CODE	DESCRIPTION	LENGTH
30-5525	Light Jaws 1 ¹ / ₂ in	8 ¹ / ₄ in 210 mm



Heaney Hysterectomy Forceps

CODE	DESCRIPTION	LENGTH
52-5322	Single Tooth	14 in 355 mm



Heaney Hysterectomy Forceps

CODE	DESCRIPTION	LENGTH
52-5301	Single Tooth, Heavy Jaws	8 ¹ / ₄ in 210 mm

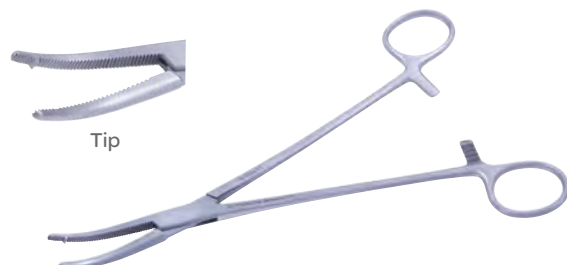

Forceps (Hysterectomy)

Heaney Hysterectomy Forceps

CODE	DESCRIPTION	LENGTH
52-5302	Double Tooth, Heavy Jaws	8 ¼ in 210 mm

Heaney Hysterectomy Forceps

CODE	DESCRIPTION	LENGTH
52-5303	Double Tooth	12 in 305 mm
52-5306	Double Tooth	14 in 355 mm

Heaney Hysterectomy Forceps

CODE	DESCRIPTION	LENGTH
52-5300	Straight, Double Tooth	8 ¼ in 210 mm
52-5304	Straight, Double Tooth	12 in 305 mm
52-5305	Straight, Double Tooth	14 in 355 mm

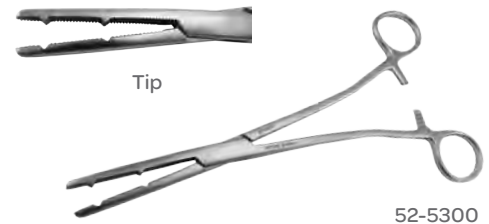

Heaney-Rezak Hysterectomy Forceps

Single Tooth

CODE	DESCRIPTION	JAW LENGTH	LENGTH
30-5800	Straight	7/8 in 48 mm	8 ½ in 216 mm
52-5311	Criss-Cross Jaws	8 ¼ in	216 mm



Hysterectomy Forceps

CODE	DESCRIPTION	JAW LENGTH	LENGTH
67-7602	Heavy Jaws, Double Tooth	1 ½ in 38 mm	12 in 305 mm
67-7605	Straight, Single Tooth	1 ¾ in 44 mm	12 in 305 mm



Forceps (Hysterectomy)

Masterson Hysterectomy Forceps

CODE	DESCRIPTION	LENGTH
37-1520	Straight, 2 x 3 Vascular Teeth	1 5/8 x 8 1/2 in 41 x 216 mm
52-5520	Straight, 2 x 3 Atraumatic Teeth	8 1/2 in 216 mm
52-5521	Curved, 2 x 3 Atraumatic Teeth	8 1/2 in 216 mm



52-5520

Rogers Hysterectomy Forceps

CODE	DESCRIPTION	JAW LENGTH	LENGTH
37-1500	Sarot Style Shanks, 2 x 3 Vascular Teeth	1 1/2 in 38 mm	8 1/2 in 216 mm
52-5554	Sarot Style Shanks, 2 x 3 Vascular Teeth, Curved		10 in 250 mm

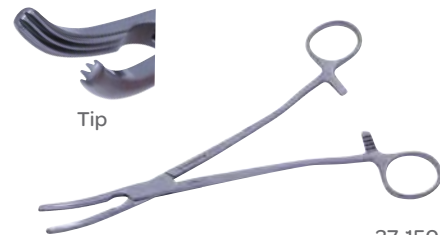

37-1500

Rogers Hysterectomy Forceps

Sarot Style Shanks

CODE	TEETH	JAW LENGTH	LENGTH
37-1501	2 x 3 Vascular Teeth	1 1/2 in 38 mm	8 1/2 in 216 mm
37-1502	2 x 3 Teeth		10 in 254 mm
52-5555	2 x 3 Vascular Teeth, Straight		10 in 250 mm

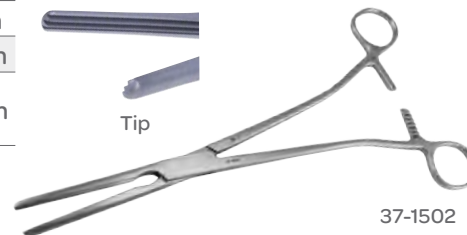

37-1502

Zep Atraumatic Hysterectomy Forceps

CODE	DESCRIPTION	LENGTH
52-9967	Angled, Offset Handle	9 1/2 in 240 mm



Zep Atraumatic Hysterectomy Forceps

CODE	DESCRIPTION	LENGTH
52-9993	Angled, Straight Handle	8 1/4 in 210 mm
52-9994	Angled, Straight Handle	9 1/2 in 240 mm
52-9995	Angled, Straight Handle	12 in 305 mm
52-9999	Angled, Straight Handle	14 in 355 mm

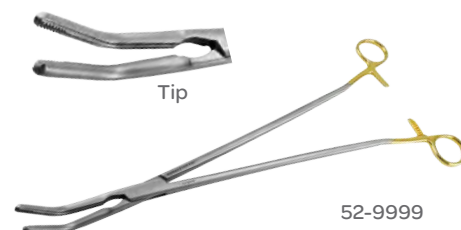

52-9999

Forceps (Hysterectomy)

Zep Atraumatic Hysterectomy Forceps

CODE	DESCRIPTION	LENGTH
52-9973	Lightly Curved, Offset Handle	14 in 355 mm

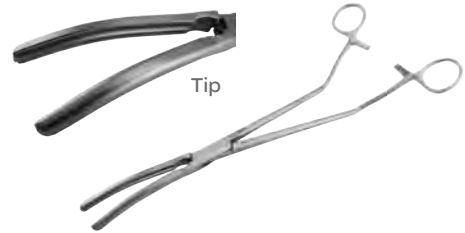

Zep Atraumatic Hysterectomy Forceps

CODE	DESCRIPTION	LENGTH
52-9987	Lightly Curved, Straight Handle	8 ¼ in 210 mm
52-9988	Lightly Curved, Straight Handle	9 ½ in 240 mm
52-9989	Lightly Curved, Straight Handle	12 in 305 mm
52-9997	Lightly Curved, Straight Handle	14 in 355 mm
52-9897	Lightly Curved, Straight Handle	16 in 405 mm

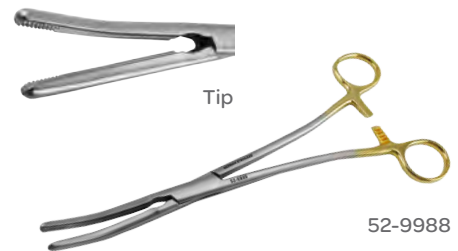

Zep Atraumatic Hysterectomy Forceps

CODE	DESCRIPTION	LENGTH
52-9972	Straight, Offset Handle	14 in 355 mm

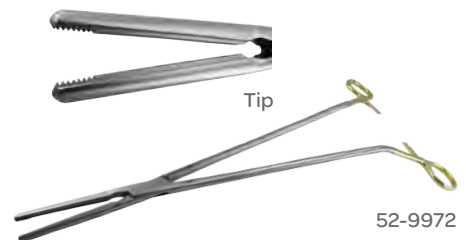

Zep Atraumatic Hysterectomy Forceps

CODE	DESCRIPTION	LENGTH
52-9984	Straight	8 ¼ in 210 mm
52-9985	Straight	9 ½ in 240 mm
52-9986	Straight	12 in 305 mm
52-9996	Straight	14 in 355 mm
52-9896	Straight	16 in 405 mm



Zep Atraumatic Hysterectomy Forceps

CODE	DESCRIPTION	LENGTH
52-9966	Strongly Curved, Offset Handle	9 ½ in 240 mm
52-9970	Strongly Curved, Offset Handle	12 in 305 mm

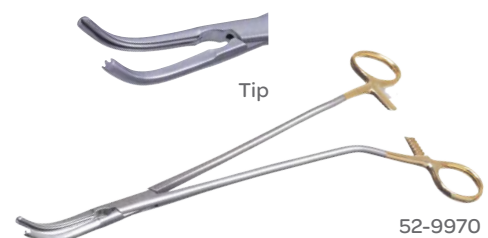

Forceps (Hysterectomy)

Zep Atraumatic Hysterectomy Forceps

Strongly Curved

CODE	DESCRIPTION	LENGTH
52-9990	Straight Handle	8¼ in 210 mm
52-9991	Straight Handle	9½ in 240 mm
52-9992	Straight Handle	12 in 305 mm
52-9998	Straight Handle	14 in 355 mm



Forceps (Micro)

Forceps

Straight, Right Tip Titanium, Closing Pressure (Appx.) 50 gms

CODE	DESCRIPTION	LENGTH
80-6001	With Platform	6 in 152 mm
80-6002	Serrated	6 in 152 mm



Tying Forceps

CODE	DESCRIPTION	TIP WIDTH	LENGTH
80-6630	Extra Fine, Titanium	0.7 mm	6 in 152 mm



Forceps (Obstetrical)

Barton Obstetrical Forceps

CODE	DESCRIPTION	LENGTH
53-5075	Obstetrical Forceps	14 in 355 mm



Forceps (Obstetrical)

Delee Obstetrical Forceps

CODE	DESCRIPTION	LENGTH
53-5041	Obstetrical Forceps	14 in 355 mm



Elliot Obstetrical Forceps

CODE	DESCRIPTION	LENGTH
53-5035	Obstetrical Forceps	12½ in 320 mm



Kielland Obstetrical Forceps

CODE	DESCRIPTION	LENGTH
30-5671	Fenestrated Blades	15½ in 394 mm



Kielland-Luikart Obstetrical Forceps

CODE	DESCRIPTION	LENGTH
53-5061	Obstetrical Forceps	15¾ in 400 mm

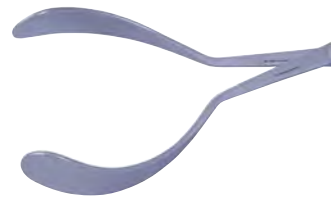

Mclean Obstetrical Forceps

CODE	DESCRIPTION	LENGTH
53-5056	Obstetrical Forceps	15 in 380 mm



Forceps (Obstetrical)

Mclean-Tucker Obstetrical Forceps

CODE	DESCRIPTION	LENGTH
30-5668	Solid Blades	15 in 381 mm

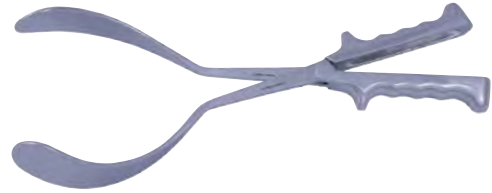

Simpson Obstetrical Forceps

CODE	DESCRIPTION	LENGTH
30-5655	Short	12 in 305 mm
30-5656	Long	14 in 356 mm



30-5656

Forceps (Ovum)

Bierer Ovum Forceps

CODE	DESCRIPTION	LENGTH
52-5031	16 mm Jaw	11 in 279 mm



Forceps (Placenta)

Kelly Placenta Forceps

CODE	DESCRIPTION	LENGTH
52-5132	Slightly Curved 10 mm Jaws Wide	12 in 305 mm

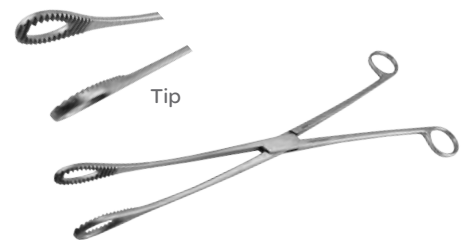

Winter Placenta Forceps

CODE	DESCRIPTION	LENGTH
53-5066	Straight	11 in 279 mm



Forceps (Placenta and Ovum)

Sanger Placenta and Ovum Forceps

CODE	DESCRIPTION	LENGTH
53-7502	Curved, Jaws 17 mm Wide	11½ in 290 mm



Forceps (Uterine)

Bozeman Uterine Dressing Forceps

CODE	DESCRIPTION	LENGTH
30-5561	Curved Shafts and Shanks	10 in 254 mm



Gaylor Uterine Biopsy Forceps

CODE	DESCRIPTION	LENGTH
52-6612	Straight	9½ in 240 mm



Hulka-Kenwick Uterine Forceps

CODE	DESCRIPTION	LENGTH
52-0849	Elevating and Manipulating	10¾ in 270 mm



Kevorkian-Younger Uterine Biopsy Forceps

Working Length 8 in, 203 mm

CODE	DESCRIPTION	OVERALL LENGTH
52-7015	With Basket	12¼ in 310 mm
52-7015E	With Basket, Ebonized	12¼ in 310 mm



Forceps (Uterine)

Laufe Uterine Polyp Forceps

CODE	DESCRIPTION	LENGTH
30-5640	Curved	8 in 203 mm

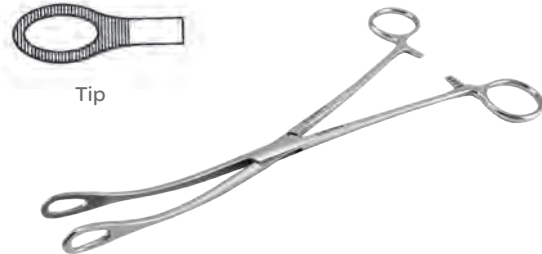

Phaneuf Uterine Artery Forceps

CODE	DESCRIPTION	LENGTH
30-5536	1x2 Teeth	8 ¼ in 210 mm



Schroeder Uterine Tenaculum Forceps

CODE	DESCRIPTION	LENGTH
30-5580	Straight, 1x1 Sharp Teeth	8 ¾ in 222 mm



Schroeder Uterine Vulsellum Forceps

CODE	DESCRIPTION	LENGTH
30-5595	2x2 Sharp Teeth	9 in 229 mm



Schubert Uterine Biopsy Forceps

CODE	DESCRIPTION	LENGTH
52-6503	Curved to Side	8 ¼ in 210 mm



Forceps (Uterine)

Somers Uterine Forceps

CODE	DESCRIPTION	LENGTH
52-5035	Curved to Side, Serrated Jaws	9 in 230 mm



Teale Uterine Vulsellum Forceps

CODE	DESCRIPTION	LENGTH
30-5615	4 x 5 Sharp Teeth	10 1/8 in 257 mm



Thoms-Gaylor Uterine Biopsy Forceps

CODE	DESCRIPTION	LENGTH
52-6610	S-Shape	9 1/2 in 240 mm



Tischler Uterine Biopsy Forceps

CODE	DESCRIPTION	LENGTH
52-6554	Handles Angled To Side	11 in 279 mm



Forceps (Utility)

Utility Forceps

Straight, Extra Fine, Titanium

CODE	TIP WIDTH	LENGTH
80-6631	0.3 mm	6 in 152 mm



Forceps (Vulsellum)

Gordon Vulsellum Forceps

Straight, 8 mm Wide

CODE	DESCRIPTION	LENGTH
52-4674	3 x 3 Sharp Prongs	10 in 250 mm

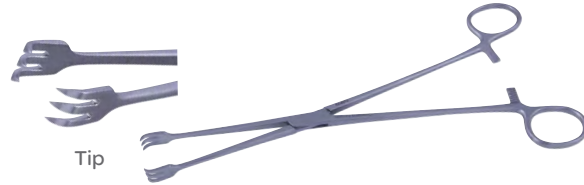

Henrotin Vulsellum Forceps

CODE	DESCRIPTION	LENGTH
52-4756	Straight, 2 x 3 Teeth	8 ¼ in 210 mm



Jacobs Uterine Vulsellum Forceps

CODE	ANGLE	WIDTH	TEETH	LENGTH
52-4706	Straight	6 mm	2 x 2 Sharp	8 ¼ in 210 mm
30-5605	Straight	6 mm	2 x 2 Sharp	8 in 203 mm
52-4726	Curved to side	6 mm	2 x 2 Sharp	8 ¼ in 210 mm



MGH Uterine Vulsellum Forceps

CODE	DESCRIPTION	TEETH	LENGTH
30-5604	Vulsellum Forceps	3 x 3 Sharp	8 in 203 mm



Forceps (Vulsellum)

Schroeder Vulsellum Forceps

CODE	DESCRIPTION	LENGTH
52-4635	Curved, 10 mm Wide	10 in 250 mm



Schroeder Vulsellum Forceps

Straight, 10 mm Wide

CODE	DESCRIPTION	LENGTH
52-4625	2 x 2 Prongs	10 in 250 mm



Hooks (Cervical)

Cervical Hook

CODE	DESCRIPTION
52-9007E	Ebonized, 3 Sharp Prongs

Hooks (IUD)

IUD Removal Hook

CODE	DESCRIPTION	LENGTH
53-0657	Malleable	10 ½ in 265 mm
53-0656	Malleable	12 in 305 mm



53-0656

Hooks

Emmett Tenaculum Hook

CODE	No.	DESCRIPTION	WIDTH	LENGTH
52-9010	#2		4 mm	9 in 230 mm
52-9010E	#2	Ebonized	4 mm	9 in 230 mm
52-9011	#2		4 mm	12 in 305 mm



Hook

CODE	No.	DESCRIPTION	LENGTH
20-4201E	#1	Ebonized	9 in 230 mm



Miya Hook

CODE	DESCRIPTION
52-6666	Hook

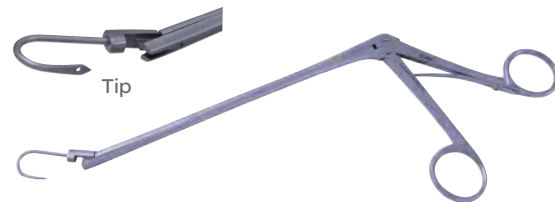

Laparoscopic Forceps (Bariatric)

Bariatric Pusher

CODE	DESCRIPTION	LENGTH
2010201	10 mm	17 3/4 in 450 mm



Manipulators (Uterine)

Cohen Uterine Manipulator

CODE	DESCRIPTION
52-0839	10 mm



Cohen Acorn Cannula

For Use with 52-0839

CODE	DESCRIPTION
52-0838	Small
52-0837	Large

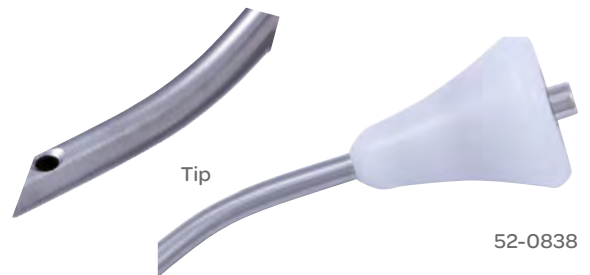

Teflon Acorn

CODE	DESCRIPTION
52-2221	Uterine Manipulator



Jarcho Self-Retaining Uterine Cannula

With Malleable Tip and Rubber Acorn with Stopcock

CODE	DESCRIPTION	LENGTH
52-0840	Uterine Cannula	13 in ³ / ₄ 350 mm

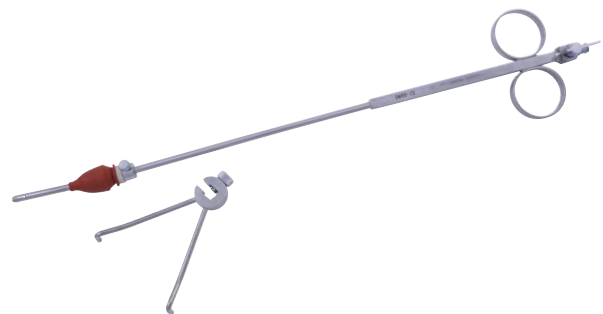

Manipulators

Kahn Uterine Trigger Cannula

With Three Flexible Teflon Tips

CODE	DESCRIPTION	LENGTH
52-0842	Uterine Trigger Cannula	13¼ in 435 mm

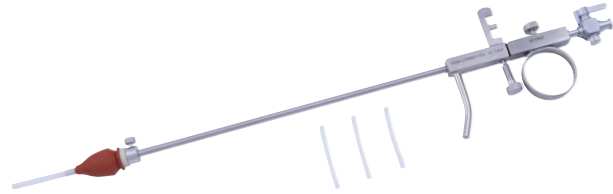

Acorn

CODE	DESCRIPTION	QTY
52-2100	Rubber Acorn	3/Pack



Lowsley Tractor

CODE	DESCRIPTION	LENGTH
51-9998	Curved	13 in 355 mm
51-9999	Straight	13 in 355 mm



51-9998

Needle Holders

Extra Fine Needle Holder

Titanium

CODE	DESCRIPTION	TIP WIDTH	LENGTH
80-6621	Curved	0.5 mm	6 in 152 mm



Needle Holders

Needle Holder

Titanium, Curved

CODE	DESCRIPTION	TIP WIDTH	LENGTH
80-6006	Fine Tip	0.7 mm	6 in 152 mm
80-6007	Standard Tip	1.0 mm	6 in 152 mm



80-6006

Probes (Measuring)

Measuring Probe with Ruler

CODE	DESCRIPTION	LENGTH
52-9125	Measuring Probe	9¾ in 245 mm



Probes (OS)

OS Finder

Set of 3

CODE	DESCRIPTION	LENGTH
52-3840	1.75 mm–3.8 mm Diameter	8 in 200 mm

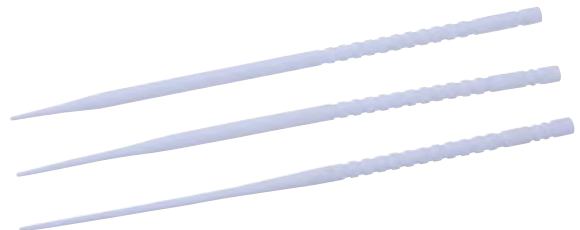

Punches (Biopsy)

Tischler Biopsy Punch

CODE	DESCRIPTION	LENGTH
52-6556	3 x 7 mm Bite	10 in 250 mm

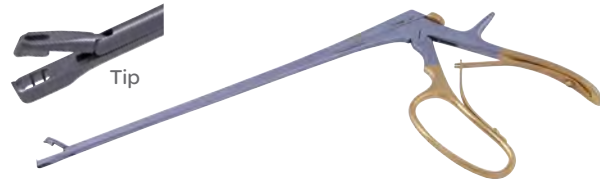

Punches (Uterine)

Baby Tischler Biopsy Punch

Down Angled

CODE	DESCRIPTION	LENGTH
52-6549	2 x 4 mm Bite	10 in 250 mm



Baby Tischler Biopsy Punch

Straight, Rotating Handle

CODE	BITE	LENGTH
52-6547	4 x 2 mm	10 in 250 mm



Baby Tischler Biopsy Punch

Straight

CODE	BITE	LENGTH
52-6550	2 x 4 mm	10 in 250 mm

Punches (Uterine)

Kevorkian-Tischler Biopsy Punch

Straight, Rotating Handle

CODE	BITE	LENGTH
52-6541	8 x 3 mm	10 in 250 mm

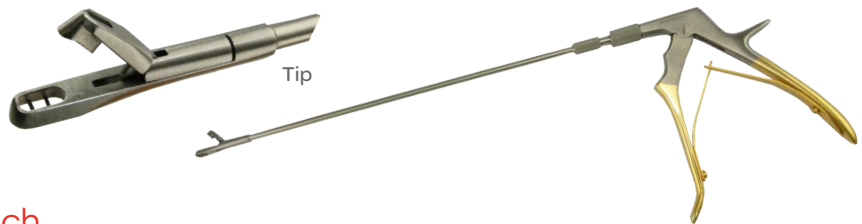

Wittner Uterine Biopsy Punch

Straight, Oblong Basket

CODE	DESCRIPTION	LENGTH
51-5510	5 x 8 mm Jaws with Teeth	8 in 203 mm

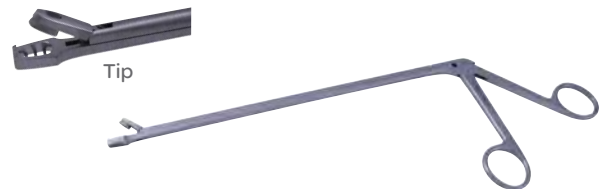

Retractors (Abdominal)

O'Sullivan-O'Connor Abdominal Retractor

CODE	DESCRIPTION	QTY
24-8500	Complete, Set Includes Items Below:	
24-8509	Frame with 2 Rotatable Lateral Blades, 25 mm x 60 mm	1
24-8511	Blades, 45 mm x 85 mm	2
24-8512	Blade, 70 mm x 105 mm	1
24-8699	Wingnuts	

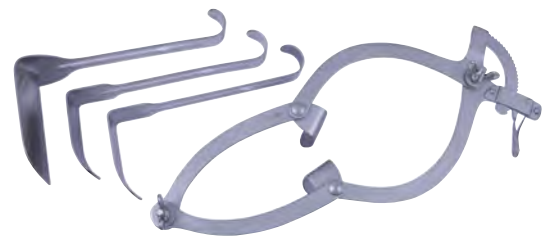

Retractors (Blade)



24-8511

O'Sullivan-O'Connor Blade Retractor

CODE	DESCRIPTION	LENGTH
24-8511	Set of 2	1 ³ / ₄ x 3 ¹ / ₃ in 45 x 85 mm
24-8512	Set of 2	2 ³ / ₄ x 4 ¹ / ₈ in 70 x 105 mm

Retractors (Frame)

O'Sullivan-O'Connor Abdominal Retractor

CODE	DESCRIPTION
24-8509	Frame Only

Retractors (Wing Nuts)



O'Sullivan-O'Connor Wing Nuts

CODE	DESCRIPTION
24-8599	For 24-8500 (Pair)

Retractors (Bookwalter®-Magrina System)



50-4547

Bookwalter®-Magrina Retractor System

CODE	NAME	QTY
50-4692	Vaginal Retractor Kit Includes Following Items:	
50-4688	Bookwalter® Lightweight Table Post, 12 in	1
50-4554	Bookwalter® Post Coupler	1
50-4582	Bookwalter® Lightweight Horizontal Flex Bar	1
50-4689	Bookwalter®-Magrina Segmented Ring with Suture Slots	1
50-4586	Bookwalter® Self-Retaining Tilting Ratchet	6
50-4694	Bookwalter® 1x4 Malleable Lateral Retractor Blade	2
50-4592	Bookwalter®-Magrina Deaver Blade, Small	1
50-4593	Bookwalter®-Magrina Deaver Blade, Large	1
50-4594	Bookwalter®-Magrina Posterior Retractor Blade	1

Retractors (Bookwalter®-Magrina Blade)



Bookwalter®-Magrina Lateral Retractor Blade

CODE	DESCRIPTION	LENGTH	
50-4591	Lateral Retractor Blade	1 in x 3 in	25 x 76 mm



50-4592

Bookwalter®-Magrina Deaver Retractor Blade

Deaver Blades

CODE	DESCRIPTION	LENGTH	
50-4592	Small	1 in x 3 ½ in	25 x 89 mm
50-4593	Large	1 in x 5 in	25 x 27 mm



Bookwalter®-Magrina Posterior Retractor Blade

CODE	DESCRIPTION	LENGTH	
50-4594	Posterior Blade	1 x 4 ½ in	25 x 114 mm



Bookwalter®-Magrina Retractor Blade

CODE	DESCRIPTION	LENGTH	
50-4694	Malleable with Lip	1 x 4 in	25 x 102 mm

Retractors (Bookwalter® Coupler)



Bookwalter® Coupler

CODE	DESCRIPTION
50-4554	Bookwalter® Post Coupler

Retractors (Bookwalter® Horizontal Bar)



Bookwalter® Horizontal Bar

CODE	DESCRIPTION
50-4582	Bookwalter® Horizontal Bar

Retractors (Bookwalter® Ratchets)



Bookwalter® Tilt Ratchet

CODE	DESCRIPTION
50-4580	Tilt ratchet articulates the blade into the surgical site

Retractors (Bookwalter® Ratchets)



Bookwalter® Self-Retaining Tilt Ratchet

CODE	DESCRIPTION
50-4686	Like the 50-4580 this ratchet articulates the blade into the surgical site, it also has an additional self-retention latch that holds the ratchet onto the Bookwalter® Retractor Ring



Bookwalter® Ratchet Key

The Bookwalter® Twister Ratchet is compatible with all Bookwalter® Ratchets and Retractor Baldes. It allows controlled fine tuning of blade position with the simple turn of a key

CODE	DESCRIPTION
BW0338015	Bookwalter® Ratchet Key

Retractors (Bookwalter®-Magrina Pelvic Rings)

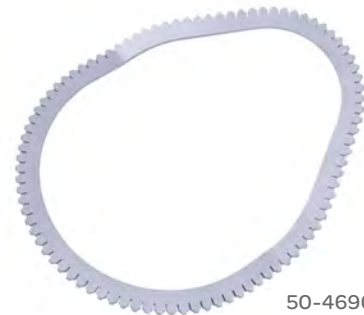

50-4690

Bookwalter®-Magrina Pelvic Rings

CODE	DESCRIPTION	LENGTH
50-4590	Fixed Basic Ovoid Ring	8 x 10 ½ in 203 x 267 mm
50-4690	Fixed Ovoid Ring with Suture Slots	8 x 10 ½ in 203 x 267 mm
50-4689	Segmented Ovoid Ring with Suture Slots	8 x 10 ½ in 203 x 267 mm

Retractors (Bookwalter® Table Posts)

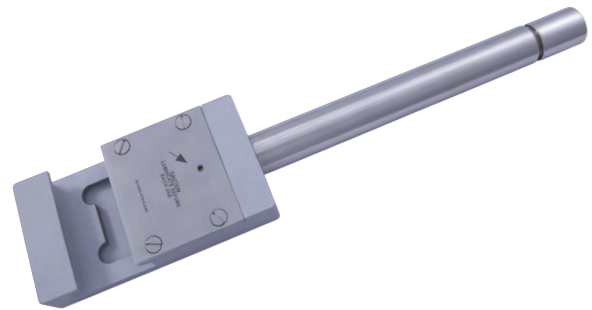

Bookwalter® Table Posts

CODE	DESCRIPTION	LENGTH
50-4683	Bookwalter® Table Post	8 in 203 mm
50-4581	Bookwalter® Table Post	12 in 305 mm

Retractors (Hysterectomy)



Heaney Hysterectomy Retractor

52-2751

CODE	DESCRIPTION	LENGTH
52-2751	Small	6 ³ / ₄ in 170 mm
52-2752	Medium	6 ³ / ₄ in 170 mm
52-2753	Large	6 ³ / ₄ in 170 mm

Retractors (Perineal)



Gelpi Perineal Retractor

Self-Retaining

CODE	DESCRIPTION	LENGTH
50-1210	Total Opening 3 ³ / ₄ in 95 mm	7 ¹ / ₄ in 184 mm

Retractors (Universal)



Delee Universal Retractor

CODE	DESCRIPTION	LENGTH
52-2340	Universal Retractor	9½ in 240 mm

Retractors (Vaginal)

Breisky Vaginal Retractor

Slight Curve



52-2601

CODE	No.	LENGTH
52-2601	#1	¾ x 4 in 19 x 102 mm
52-2602	#2	1 x 4 in 25 x 102 mm
52-2603	#3	1¼ x 4 in 32 x 102 mm
52-2604	#4	1⅜ x 4 in 35 x 102 mm
52-2605	#5	1⅝ x 4 in 41 x 102 mm
52-2606	#6	1⅞ x 4¾ in 29 x 121 mm
52-2607	#7	1⅜ x 5⅛ in 35 x 130 mm
52-2609	#9	1⅜ x 6¼ in 35 x 159 mm
52-2610	#10	1 x 6⅙ in 25 x 170 mm

Eastman Vaginal Retractor



52-2332

CODE	No.	LENGTH
52-2331	#1	1⅜ x 3 in 35 x 76 mm
52-2332	#2	1⅜ x 3½ in 35 x 89 mm
52-2333	#3	1⅝ x 4 in 41 x 102 mm

Heaney-Simon Vaginal Retractor



50-5570

CODE	BLADE	LENGTH
50-5570	1 x 4½ in 25 x 114 mm	10¼ in 260 mm
52-2727	1 x 4½ in 25 x 114 mm	11 in 279 mm

Retractors (Vaginal)

Jackson Vaginal Retractor



50-5540

CODE	SIZE	BLADE	LENGTH
52-2301	#1	1 ³ / ₈ x 3 in 35 x 76 mm	7 ¹ / ₄ in 184 mm
52-2302	#2	1 ³ / ₈ x 3 ¹ / ₂ in 35 x 89 mm	7 ¹ / ₄ in 184 mm
52-2303	#3	1 ¹ / ₂ x 4 in 38 x 102 mm	7 ¹ / ₄ in 184 mm
50-5540	Small	1 ¹ / ₂ x 3 in 38 x 76 mm	6 ³ / ₄ in 171 mm
50-5541	Medium	1 ¹ / ₂ x 3 ¹ / ₂ in 38 x 89 mm	6 ³ / ₄ in 171 mm
50-5542	Large	1 ¹ / ₂ x 4 in 38 x 102 mm	6 ³ / ₄ in 171 mm

Lateral Vaginal Wall Retractor



52-0799I

CODE	DESCRIPTION	BLADE	LENGTH
52-0799I	Insulated	1 x 2 ¹ / ₂ in 25 x 64 mm	10 ³ / ₄ in 270 mm
52-0799E	Ebonized	1 x 2 ¹ / ₂ in 25 x 64 mm	10 ³ / ₄ in 270 mm
52-0799		1 x 2 ¹ / ₂ in 25 x 64 mm	10 ³ / ₄ in 270 mm

Redundant Wall Retractor



52-0790

CODE	DESCRIPTION	BLADE
52-0790	Wall Retractor	³ / ₄ x 5 in 19 mm x 127 mm

Sims Vaginal Retractor

Hollow Grip Retractor



52-2020

CODE	DESCRIPTION	LENGTH
52-2020	Small	2 ¹ / ₂ x 1 in 64 x 25 mm
52-2021	Medium	3 x 1 ¹ / ₄ in 76 x 32 mm
52-2022	Large	3 ¹ / ₂ x 1 ¹ / ₂ in 89 x 38 mm

Rulers (Depth)

Depth Ruler

CODE	LENGTH
52-9141	11 in 279 mm



Rulers (Width)

Width Ruler

CODE	DESCRIPTION	LENGTH
52-9140	3 mm Wide	11 in 279 mm



Scissors (Episiotomy)

Braun Episiotomy Scissors

CODE	DESCRIPTION	LENGTH
54-5579	One Guarded Blade	8½ in 216 mm



Braun-Stadler Episiotomy Scissors

CODE	DESCRIPTION	LENGTH
54-5579	Episiotomy Scissors	6 in 150 mm



Roberts Episiotomy Scissors

CODE	DESCRIPTION	LENGTH
54-5526	Serrated Blade	5½ in 140 mm



Scissors (Episiotomy)

Waldmann Episiotomy Scissors

CODE	DESCRIPTION	LENGTH
53-3118	Episiotomy Scissors	7¼ in 185 mm



Scissors (Micro)

Scissors

Titanium, Serrated Jaw

CODE	DESCRIPTION	LENGTH
80-6008	Straight, Fine Tip	6 in 152 mm
80-6009	Straight, Regular Tip	6 in 152 mm



Scissors (Umbilical)

American Umbilical Scissors

CODE	DESCRIPTION	LENGTH
54-5545	Umbilical Scissors	4 in 102 mm



Scissors (Umbilical)

Busch Umbilical Scissors

CODE	DESCRIPTION	LENGTH
54-5578	Curved on Side	6½ in 165 mm



Scissors (Uterine)

Sims Uterine Scissors

Blunt

CODE	DESCRIPTION	LENGTH
54-5500	Straight	8 in 203 mm
54-5503	Curved	8 in 203 mm



54-5000

Scissors

Zep Scissors

Fine Tungsten Carbide Blades

CODE	DESCRIPTION	LENGTH
32-889	Curved	9 in 230 mm
32-892	Curved	10½ in 265 mm
32-895	Curved	12 in 305 mm



32-892

Zep Scissors

Fine Tungsten Carbide Blades

CODE	DESCRIPTION	LENGTH
32-890	Full Curve	9 in 230 mm
32-893	Full Curve	10½ in 260 mm
32-896	Full Curve	12 in 300 mm
32-898	Full Curve	14 in 350 mm



32-898

Sounds (Uterine)



Emmett Uterine Sound

CODE	DESCRIPTION	LENGTH
52-4050	Uterine Sound	11 $\frac{3}{4}$ in 300 mm



52-4033

Simpson Uterine Sound

Silver Plated

CODE	DESCRIPTION	LENGTH
52-4033	Graduated in Inches, Malleable	13 in 330 mm
58-5669	Graduated in Centimeters	13 $\frac{3}{8}$ in 340 mm



52-4001

Sims Uterine Sound

Malleable, Silver Plated

CODE	DESCRIPTION	LENGTH
52-4001	Graduated in Centimeters	12 $\frac{1}{2}$ in 320 mm
52-4002	Graduated in Inches	12 $\frac{1}{2}$ in 320 mm

Speculums (Endocervical)

Kogan Endocervical Speculum

Without Gauge

CODE	DESCRIPTION	LENGTH
52-3950	S-Shaped, Fenestrated Blades	9 $\frac{3}{4}$ in 245 mm



Speculums (Vaginal)

Auvard Weighted Vaginal Speculum

Without Gauge

CODE	DESCRIPTION	WEIGHT	BLADE SIZE
79-5506		2½ lbs	1½ x 3 in 38 x 76 mm
52-2786		2 lbs	2¾ x 1½ in 70 x 38 mm
52-2787		2½ lbs	2¾ x 1½ in 70 x 38 mm
52-2788		3 lbs	2¾ x 1½ in 70 x 38 mm
52-2793	Acute Angle Blade	2½ lbs	4 x 1¾ in 102 x 44 mm
52-2793E	Ebonized	2½ lbs	4 x 1¾ in 102 x 44 mm
79-5509		2½ lbs	3½ x 1¾ in 89 x 44 mm



52-2786E

Steiner-Auvard Vaginal Speculum

CODE	DESCRIPTION	WEIGHT	BLADE WIDTH
79-5506	Vaginal Speculum	2½ lbs	1¾ in 44 mm



Berlind-Auvard Vaginal Weighted Speculum

CODE	DESCRIPTION	WEIGHT	BLADE	LENGTH
52-2958	Vaginal Speculum	2½ lbs	1 5/8 x 4 1/4 in 36 x 108 mm	
79-5592	Vaginal Speculum		1 3/4 x 4 in 44 x 102 mm	9 1/4 in 235 mm



52-2958

Speculums (Vaginal)

Clinton Pederson Vaginal Speculum

CODE	WEIGHT	DESCRIPTION	BLADE
52-0519R	2½ lbs	Right Side Open	1¾ in 44 mm



Garrigue Vaginal Speculum

With Smoke Tube and Ebonized

CODE	WEIGHT	BLADE
52-2736	2½ lbs	3 x 1½ in 76 x 38 mm
52-2737	3 lbs	3 x 1½ in 76 x 38 mm



Graves Modified Vaginal Speculum

Open Right

CODE	DESCRIPTION	BLADE
52-0755	Angled 45°	1⅜ x 4 in 35 x 102 mm
52-0760	Angled 90°	1⅜ x 4 in 35 x 102 mm



52-0760

Graves Modified Vaginal Speculum

Open Right, Extra Long

CODE	DESCRIPTION	BLADE
52-0766	Angled 90°	1½ x 6 in 38 x 152 mm
52-0767	Angled 90°	1½ x 7 in 38 x 177 mm



52-0766

Speculums (Vaginal)

Graves Vaginal Speculum

CODE	DESCRIPTION	BLADE
52-0760L	90° Left Open	1½ x 4 in 38 x 152 mm



Graves Vaginal Speculum

Modified Pattern Right Side Open

CODE	DESCRIPTION	BLADE
52-0755	Angled 45°	1⅜ x 4 in 35 x 152 mm



Graves Vaginal Speculum

With Smoke Tube, Insulated

CODE	DESCRIPTION
52-0755-SI	Angled 45°

Graves Vaginal Speculum

CODE	SIZE	BLADE
52-0607	Small	¾ x 3 in 19 x 76 mm
52-0610	Medium	¾ x 3 in 19 x 76 mm
52-0612	Large	1⅜ x 4 in 35 x 102 mm
52-0619	Extra Large	1½ x 6 in 38 x 152 mm



52-0607

Speculums (Vaginal)

Graves Vaginal Speculum

With Smoke Tube, Ebonized

CODE	DESCRIPTION	BLADE
52-0610ES	Medium	1½ x 6 in 38 x 152 mm
52-0612ES	Large	1¾ x 4 in 35 x 102 mm
52-0619ES	Extra Large	1½ x 6 in 38 x 152 mm



52-0610ES

Graves Vaginal Speculum

Insulated Blades

CODE	DESCRIPTION	BLADE
52-0610-I	Medium	¾ x 3 in 19 x 76 mm
52-0612-I	Large	1¾ x 4 in 35 x 102 mm

Graves Vaginal Speculum

CODE	DESCRIPTION	BLADE
52-0620	Extra Large	1¾ x 7 in 45 x 178 mm

Speculums (Vaginal)

Graves Vaginal Speculum

CODE	DESCRIPTION	BLADE	
79-5514	Medium	1¼ x 4 in	32 x 102 mm
79-5515	Large	1¼ x 4½ in	32 x 114 mm



79-5514

Graves Vaginal Speculum

Modified Model

CODE	DESCRIPTION	BLADE	
79-5590	Large	1¼ x 4 in	32 x 102 mm



Hardy™-Duddy Vaginal Speculum

CODE	DESCRIPTION	WEIGHT
52-2770	Vaginal Speculum	3¼ lbs.

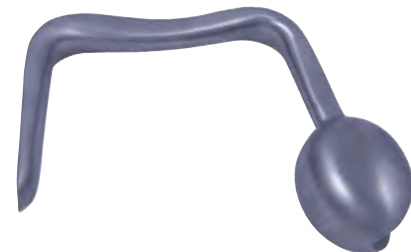

Henrotin Vaginal Speculum

CODE	DESCRIPTION	WEIGHT	BLADE	
52-2955	Vaginal Speculum	3¼ lbs.	3½ x 1½ in	89 x 30 mm



Speculums (Vaginal)

Kristeller Vaginal Speculum

Concave

CODE	SIZE	BLADE	LENGTH
52-2511	1	1 x 4 1/3 in	25 x 110 mm 3 1/2 x 1 1/5 in 89 x 55 mm



O'Sullivan O'Connor Vaginal Retractor

CODE	SIZE	DESCRIPTION	BLADE
52-9000	Complete Set, includes the following:		
52-2901	#1	Center Blade	5/8 x 1 3/4 in 16 x 45 mm
52-2902	#2	Center Blade	1 1/2 x 3 1/3 in 38 x 84 mm
52-2903	#3	Center Blade	1 3/4 x 3 1/2 in 45 x 89 mm
52-2905		Frame Only	

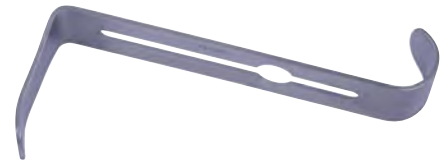

52-2901

Pederson Vaginal Speculum

CODE	DESCRIPTION	BLADE
52-0506	Extra Narrow	1/2 x 4 1/2 in 13 x 114 mm
52-0508	Right Side Open	4 x 1 in 114 x 25 mm
52-0512R	Right Side Open	1 x 4 3/4 in 25 x 120 mm
52-0519SI	With Smoke Tube, Extra Large, Insulated	1 x 6 in 25 x 152 mm
79-5521	Medium	7/8 x 3 1/2 in 22 x 89 mm
79-5522	Large	7/8 x 3 1/2 in 22 x 89 mm



79-5521

Speculums (Vaginal)

Pederson Vaginal Speculum

CODE	SIZE	BLADE	
52-0507	Small	$\frac{1}{2} \times 3$ in	13 x 76 mm
52-0510	Medium	$\frac{7}{8} \times 4$ in	22 x 102 mm
52-0512	Large	$1 \times 4 \frac{3}{4}$ in	25 x 120 mm
52-0519	Extra Large	1×6 in	25 x 152 mm



52-0507

Pederson Vaginal Speculum with Smoke Tube

Ebonized

CODE	SIZE	BLADE	
52-0507ES	Small	$\frac{1}{2} \times 3$ in	13 x 76 mm
52-0510ES	Medium	$\frac{7}{8} \times 4$ in	22 x 102 mm
52-0512ES	Large	$1 \times 4 \frac{3}{4}$ in	25 x 120 mm
52-0519ES	Extra Large	1×6 in	25 x 152 mm



52-0507ES

Sims Vaginal Speculum

Double Ended

CODE	No.	BLADE	
52-2001	#1	$1 \times 2 \frac{3}{4} \times 1 \frac{1}{8} \times 3$ in	25 x 70 x 29 x 76 mm
52-2002	#2	$1 \times 2 \frac{3}{4} \times 1 \frac{1}{2} \times 3 \frac{1}{4}$ in	25 x 70 x 38 x 83 mm
52-2003	#3	$1 \frac{1}{2} \times 3 \frac{1}{4} \times 1 \frac{5}{8} \times 3 \frac{1}{2}$ in	38 x 83 x 41 x 89 mm



52-2003

Weisman-Graves Vaginal Speculum

CODE	DESCRIPTION
52-0400	Left Side Open



Spoons

Spoon

CODE	DESCRIPTION
52-1111	Small
52-1112	Soup Size



52-1111

Tenaculums (Hook)

Emmett Tenaculum Hook

Sharp

CODE	DESCRIPTION	LENGTH
20-4201	#1	8 ³ / ₄ in 220 mm
20-4203	#3	8 ³ / ₄ in 220 mm
20-4204	#4	8 ³ / ₄ in 220 mm



20-4201

Tenaculums

Adair Tenaculum Forceps

CODE	DESCRIPTION	LENGTH
52-4419	Straight	7 ¹ / ₂ in 190 mm



Tenaculums

Barrett Tenaculum Forceps

CODE	DESCRIPTION	LENGTH
52-4418	Straight	7 in 175 mm

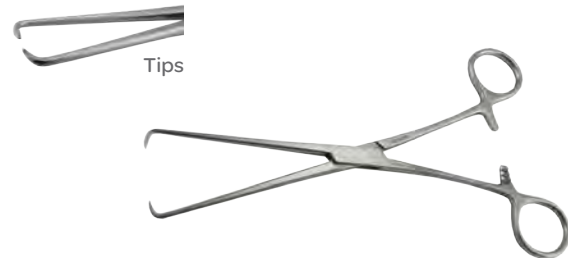

Braun Tenaculum Forceps

CODE	DESCRIPTION	LENGTH
52-4426	Straight	10 in 250 mm
52-4426E	Straight, Ebonized	10 in 250 mm



Schroeder Uterine Tenaculum Forceps

CODE	DESCRIPTION	LENGTH
52-4425	Straight	10 in 250 mm



Skene Tenaculum Forceps

CODE	DESCRIPTION	LENGTH
52-4575	Curved	9½ in 240 mm



Tenaculums (Uterine)

Hulka Uterine Tenaculum

CODE	DESCRIPTION	LENGTH
52-0740	With Sound	8 ³ / ₄ in 220 mm



Hulka Uterine Tenaculum

CODE	DESCRIPTION	LENGTH
52-0742	With Insulated Sound	8 ³ / ₄ in 220 mm



Hulka Uterine Tenaculum

Single Tooth

CODE	DESCRIPTION	LENGTH
52-0745	3.5 mm Probe Tip	8 ³ / ₄ in 220 mm





Scan the code above to learn more about our Ophthalmology portfolio.

Ophthalmology Portfolio



symmetry surgical™

Ophthalmology



Blades	OPH-2	Markers	OPH-39
Calipers	OPH-2	Needles	OPH-40
Cannulas	OPH-3	Needle Holders	OPH-41
Clamps	OPH-8	Plates	OPH-45
Curettes	OPH-8	Probes	OPH-45
Depressors	OPH-9	Retractors	OPH-46
Dilators	OPH-10	Rings	OPH-48
Forceps	OPH-11	Rotators	OPH-49
Gauges	OPH-27	Scissors	OPH-50
Hooks	OPH-27	Shields	OPH-67
Introducers	OPH-34	Spatulas	OPH-67
Intubation Sets	OPH-34	Speculums	OPH-69
Knives	OPH-35	Spoons	OPH-72
Lens Crackers	OPH-35	Spuds	OPH-73
Loops	OPH-36	Tonometers	OPH-73
Manipulators	OPH-37		

Questions? Contact us at customerservice@symmetrysurgical.com or learn more at symmetrysurgical.com



The Surgical Instrument Desk Reference

How to Use Our Catalog

The Symmetry Surgical catalog is designed with you in mind, to be your trusted resource for surgical instrumentation. We took great care in creating an easy-to-use, robust catalog and we think you'll be pleased with the design as you become more familiar with our broad portfolio.

Layout

The catalog is organized by surgical specialty *and* product function.

And we know that it is difficult to pick up an instrument and know what specialty it's listed in. To make your job easier, we've sorted the instruments in our portfolio by surgical function, too, including Energy, Laparoscopic, Retractors and Sterilization Solutions.

U.S. Customer Service

Your Symmetry Surgical Customer Service team wants to make ordering surgical instruments the easiest part of your day. We accept orders via phone, fax, email, our website, Global Healthcare Exchange (GHX) and through the mail.

PHONE

800.251.3000

(Available Monday through Friday, 8:30 AM–6:30 PM EST)

FAX

800.342.3272

EMAIL

customerservice@symmetrysurgical.com

ONLINE

symmetrysurgical.com

MAILING ADDRESS

Symmetry Surgical
Attn: Customer Service
3034 Owen Drive
Antioch, TN 37013

The Surgical Instrument Desk Reference

International Customer Service

PHONE

Symmetry Surgical Switzerland GmbH
+41 (0) 52 557 59 00
(Available Monday through Friday, 7:00-16:00 GMT)

Symmetry Surgical, Inc., USA
615.964.5672
(Available Monday through Friday, 8:30 AM–6:30 PM EST)

FAX

Symmetry Surgical Switzerland GmbH
+41 (0) 52 557 59 99

EMAIL

customerservice@symmetrysurgical.com
internationalorders@symmetrysurgical.com

ONLINE

symmetrysurgical.com

MAILING ADDRESS

Symmetry Surgical Switzerland GmbH
Bühlstrasse 27
CH-8200 Schaffhausen
Switzerland

Symmetry Surgical, Inc.
3034 Owen Drive
Antioch, TN 37013

INTERNATIONAL PAYMENT TERMS/RETURN GOODS POLICY/INSTRUMENT REPAIR & RESTORE PROGRAM/LITERATURE REQUESTS

Please contact your local distributor. Locate a local distributor contact, International Customer Service at +41 (0) 52 557 59 00 or 615.964.5672 (US).

Cardiovascular/Thoracic

Energy

Ear, Nose & Throat

General

Laparoscopic

Neurology

Obesity

OB/GYN

Ophthalmology

Orthopedics & Arthroscopy

Pediatrics

Rectal

Retractors

Spine

Urology

Sterilization Solutions

Alphabetical & Numeric Indexes

Blades

Corneal Trephine Blades

CODE	DESCRIPTION	DIAMETER
60-4080	Short	8.0 mm
60-4175	Long	7.5 mm
60-4177	Long	7.75 mm



60-4080

Calipers

Castroviejo Caliper

CODE	DESCRIPTION	LENGTH
60-1931	0–20 mm Scale	3½ in 9.0 cm
60-1932	Curved Shaft	3½ in 9.0 cm



60-1931

Jameson Caliper

CODE	DESCRIPTION	LENGTH
60-1934	Caliper	4 in 10 cm



Townley Calipers

CODE	DESCRIPTION	LENGTH
60-1936	Working Length	4 in 10 cm



Cannulas

Air Injection Cannula

CODE	DESCRIPTION	GAUGE
60-1148	5.0 mm	27 G
60-1149	5.0 mm	30 G



Atkinson Retrobulbar Needle

CODE	DESCRIPTION	GAUGE
60-1225	Sharp Rounded Point	23 G
60-1226	Sharp Rounded Point	25 G

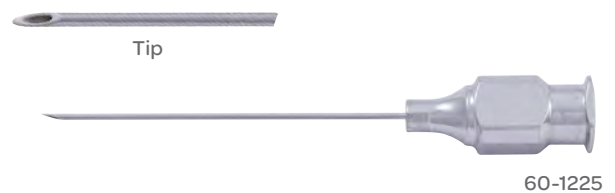

Binkhorst Irrigating Cannula

CODE	DESCRIPTION	GAUGE
60-1229	Straight, Smooth Blunt Tip, Front Opening	22 G



Bishop Harmon Irrigating Cannula

CODE	DESCRIPTION	GAUGE
60-1186	Silicone Bulb, Includes 60-1192, 60-1187 and 60-1193	
60-1187	Irrigating Cannula	19 G
60-1192	Adapter for Irrigator	19 G
60-1193	Silicone Bulb	19 G

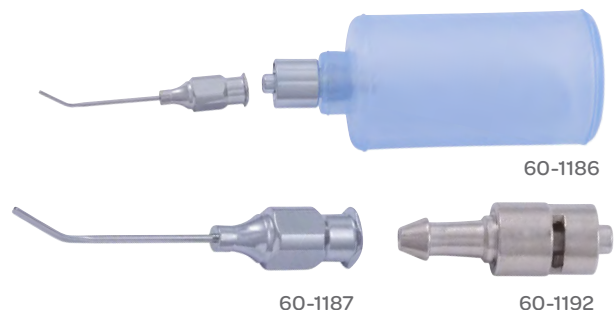

Cannulas

Bracken Anterior Chamber Cannula

CODE	DESCRIPTION	GAUGE	LENGTH
60-1189	Blunt	27 G	$\frac{3}{4}$ in 2.0 cm

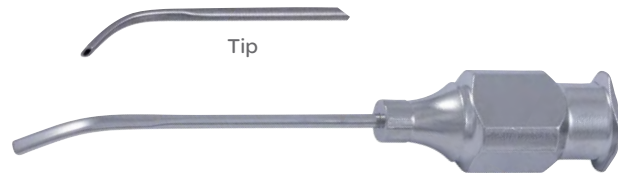

Gills-Welsh Irrigating Cannula

CODE	DESCRIPTION	GAUGE
60-1198	Angled, 5.0 mm	25 G
60-1201	Angled, 10 mm	25 G

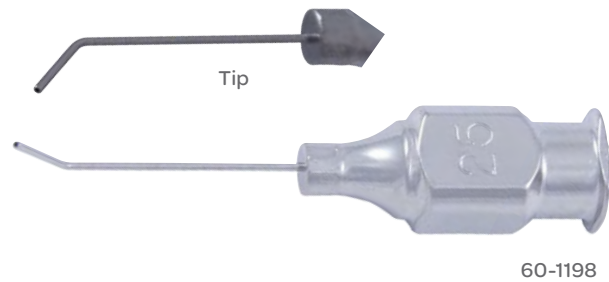

Gills-Welsh Olive Tip Cannula

CODE	DESCRIPTION	GAUGE
60-1180	Angled 45°	25 G

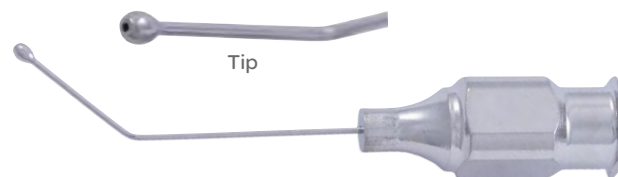

Gimbel Irrigating Cannula

CODE	DESCRIPTION
60-0226	26 French



Cannulas

Healon Injection Cannula

CODE	DESCRIPTION	GAUGE	LENGTH
60-1227	Flat Tip	21 G	1¼ in 3.0 cm



Jenson Capsule Polisher

CODE	DESCRIPTION	GAUGE
60-1147	Front Port, Diamond Dust Tip	27 G



Kelman Cyclodialysis Cannula

CODE	DESCRIPTION	GAUGE
60-1086	Port on Left Side	19 G



Kellan Hydrodissection Cannula

CODE	DESCRIPTION	GAUGE	LENGTH
60-1216	Curved, Vertical Flat Tip	25 G	¼ in 2.0 cm



Cannulas

Kratz Capsule Scraper

CODE	DESCRIPTION	GAUGE
60-1131	Sandblasted, Angled 30°, 1.0 mm Tip	22 G

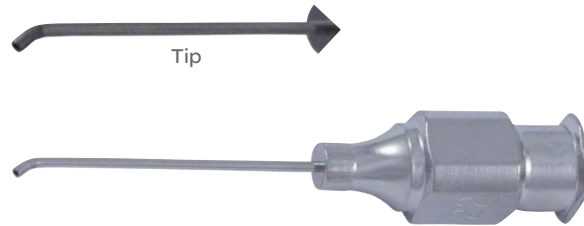

Kratz Lens Manipulator Cannula

CODE	DESCRIPTION	GAUGE
60-1130	Manipulator Cannula	30 G

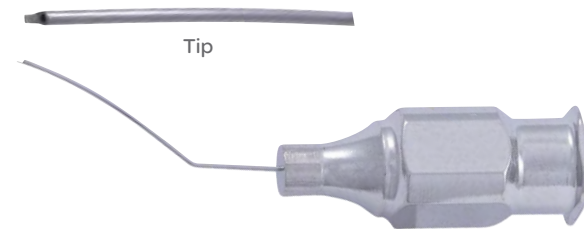

Lacrimal Cannula

CODE	DESCRIPTION	GAUGE	LENGTH
60-1211	Straight	23 G	1½ in 3.5 cm



Cannulas

McIntyre Anterior Chamber Cannula

CODE	DESCRIPTION	GAUGE
60-1154	Straight	23 G
60-1156	Straight	26 G
60-1158	Straight	30 G
60-1157	Angled	26 G
60-1159	Angled	30 G



McIntyre-Binkhorst Irrigating Cannula

CODE	DESCRIPTION	GAUGE
60-1235	Right, Smooth Blunt Tip, Front Opening	26 G



Randolph Cyclodialysis Cannula

CODE	DESCRIPTION	GAUGE
60-1087	2.0 mm Tip	19 G



Scheie Anterior Chamber Cannula

CODE	DESCRIPTION	GAUGE	LENGTH
60-1188	Blunt	27 G	$\frac{3}{4}$ in 2.0 cm

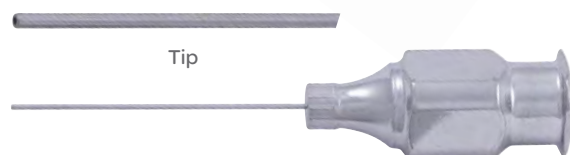

Troutman Alpha-Chymotrypsin Cannula

CODE	DESCRIPTION	GAUGE
60-1179	Bulb Tip	25 G



Clamps

Serrefine

CODE	DESCRIPTION	LENGTH
60-2026	Straight	1½ in 3.5 cm
60-2027	Curved	1½ in 3.5 cm



60-2026

Curettes

Heath Chalazion Curette

CODE	DESCRIPTION	LENGTH
60-1428	#1 1.0 mm	5 in 12.5 cm
60-1429	#2 2.0 mm	5 in 12.5 cm
60-1430	#3 3.0 mm	5 in 12.5 cm

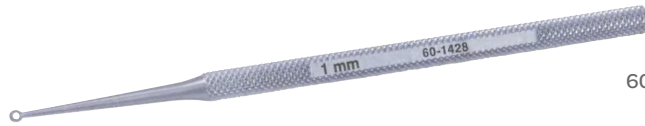

60-1428

Kraff Capsule Polishing Curette

CODE	DESCRIPTION	GAUGE
60-1260	1.75 mm Cup	25 G

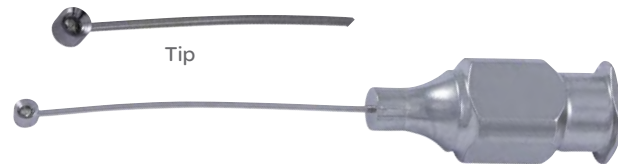

Meyerhoeffer Curette

CODE	DESCRIPTION	LENGTH
60-1421	#0 1.5 mm	5¼ in 13.5 cm
60-1422	#1 1.7 mm	5¼ in 13.5 cm
60-1423	#2 2.0 mm	5¼ in 13.5 cm
60-1424	#3 2.5 mm	5¼ in 13.5 cm
60-1425	#4 3.5 mm	5¼ in 13.5 cm



60-1421

Nightingale Capsule Polishing Curette

CODE	DESCRIPTION
60-1432	1.7 mm Diameter, Open Ring, Semi-Sharp



Depressors

Flynn Scleral Depressor

CODE	DESCRIPTION	LENGTH
60-2009	Lens Loop Style	3 1/8 in 8.0 cm



O'Connor Scleral Depressor-Marker

CODE	DESCRIPTION	LENGTH
60-2012	3.0 mm Teardrop on One End, 1.5 mm Gass Marker on Other End	5 1/8 in 13 cm



Schepens Scleral Depressor

CODE	DESCRIPTION
60-2000	Small, 16 mm Wide Bar



Shocket Scleral Depressor

Double-Ended, Teardrop-Shaped Tip

CODE	DESCRIPTION	LENGTH
60-2010	6.0mm Wide Bar, Pocket Clip, Small Thimble	5 1/8 in 13 cm



Urretts-Zavalía Depressor Pick

CODE	DESCRIPTION
60-2011	Triangular Tip



Dilators

Castroviejo Lacrimal Dilator

CODE	DESCRIPTION	LENGTH
60-1991	Double-Ended	5 in 12.5 cm



Ruedemann Lacrimal Dilator

CODE	DESCRIPTION
60-1996	Short



Wilder Lacrimal Dilator

CODE	DESCRIPTION	LENGTH
60-1993	Short	4 in 10 cm
60-1994	Medium	4 in 10 cm
60-1995	Long	4 in 10 cm

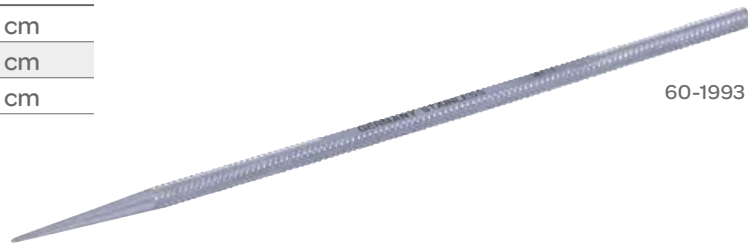

Simcoe Cortex Extractor

CODE	DESCRIPTION	GAUGE	LENGTH
60-1203	Extractor	23 G	½ in 1.27 cm

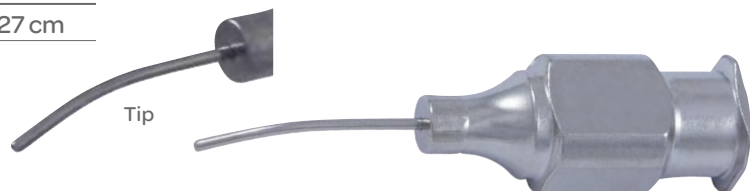

Forceps

Anis Lens Holding Forceps

CODE	DESCRIPTION	TIP SIZE
60-1730	45° Angle	0.5 mm

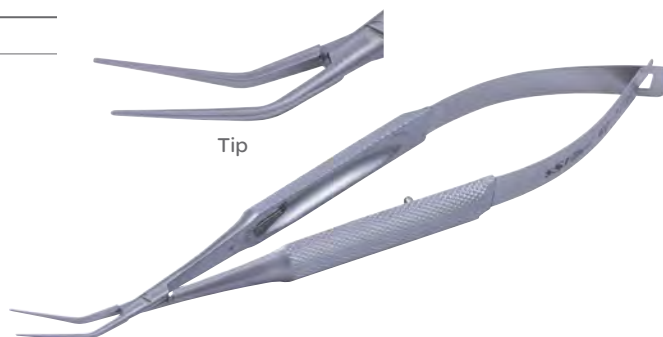

Baird Chalazion Forceps

Locking Thumb Screw

CODE	DESCRIPTION	LENGTH
60-1717	Open Blade 8.0 x 12 mm	3½ in 9.0 cm



Barraquer Cilia Forceps

CODE	DESCRIPTION	LENGTH
60-1699	Slightly Curved Jaws, with Platform	4¼ in 10.8 cm

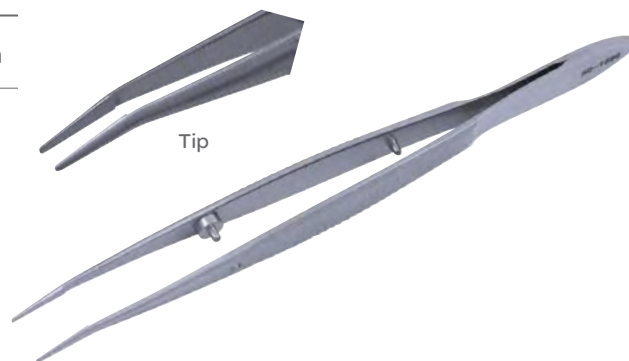

Bechert-McPherson Tying Forceps

10 mm, Tying Platform

CODE	DESCRIPTION	LENGTH
60-1578	Angled, Smooth Jaws	3⅞ in 8.0 cm



Forceps

Berke Ptosis Forceps

Serrated Blades, Slide Lock

CODE	DESCRIPTION	LENGTH	
60-1669	20 mm Blades	4 in	10 cm
60-1670	27 mm Blades	4 in	10 cm

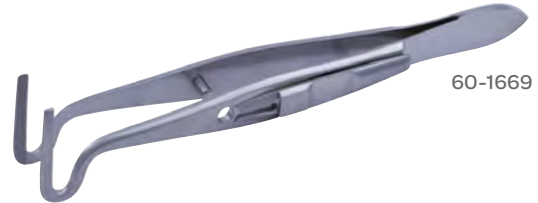

60-1669

Binkhorst Lens Forceps

CODE	DESCRIPTION
60-1736	Cross Action



Bishop Harmon Tissue Forceps

CODE	DESCRIPTION	TEETH	LENGTH	
60-1522	Standard	1x2	3 3/8 in	8.57 cm
60-1523	Extra Delicate, Straight	1x2	3 3/8 in	8.57 cm
60-1524	Cross-Serrated Tips	None	3 3/8 in	8.57 cm



60-1522

Blaydes Lens Holding Forceps

Narrow, Smooth Jaws

CODE	DESCRIPTION	LENGTH	
60-1739	Angled 45°, Very Delicate	4 1/2 in	11.5 cm

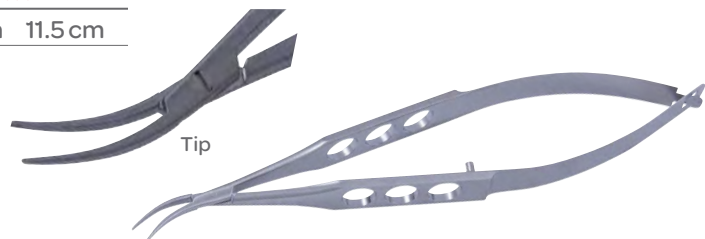

Tip

Forceps

Bonn Suture Forceps

Without Platform, Extra Delicate

CODE	TEETH	LENGTH
60-1641	0.12 mm	3 in 7.5 cm



Bonn Suture Forceps

With Platform, Extra Delicate

CODE	TEETH	LENGTH
60-1660	0.12 mm	3 3/4 in 9.5 cm



Bonaccolto Utility Forceps

Cross-Serrated Tip, Rear of Jaw Fluted

CODE	TIPS	LENGTH
60-1677	1.2 mm	4 1/8 in 10.5 cm



Botvin Iris Forceps

CODE	TEETH	LENGTH
60-1512	1x2	3 in 7.5 cm



Bracken Iris Forceps

Cross-Serrated Tips

CODE	DESCRIPTION	LENGTH
60-1506	Curved	3 9/10 in 9.90 cm



Forceps

Castroviejo Fixation Forceps

Wide Handle, without Platform, 1 x 2 Teeth

CODE	DESCRIPTION	LENGTH
60-1547	0.3 mm Teeth	4 ¼ in 10.8 cm
60-1548	0.5 mm Teeth	4 ¼ in 10.8 cm

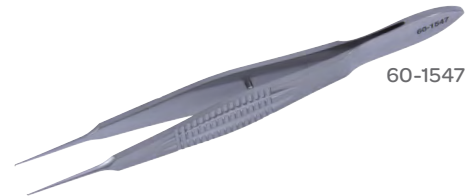

60-1547

Castroviejo Titanium Suture Forceps

CODE	DESCRIPTION	LENGTH
60-1631T	Straight Jaw, 0.3 mm Teeth	4 ½ in 11.5 cm
60-1632T	Straight Jaw, 0.5 mm Teeth	4 ½ in 11.5 cm



60-1632T

Castroviejo Suture Forceps

Wide Handle with Platform

CODE	DESCRIPTION	TEETH	LENGTH
60-1629	Teeth on Straight Shaft	0.12 mm	4 ¼ in 10.8 cm
60-1631	Teeth on Straight Shaft	0.3 mm	4 ¼ in 10.8 cm
60-1632	Teeth on Straight Shaft	0.5 mm	4 ¼ in 10.8 cm
60-1637	Teeth on Straight Shaft	0.9 mm	4 ¼ in 10.8 cm
60-1634	Teeth on Straight Shaft	1.5 mm	4 ¼ in 10.8 cm
60-1630	Teeth on Angled Shaft	0.12 mm	4 ⅝ in 10.5 cm
60-1628	Teeth on Angled Shaft	0.3 mm	4 ⅝ in 10.5 cm
60-1627	Teeth on Angled Shaft	0.5 mm	4 ⅝ in 10.5 cm



60-1629

Castroviejo Suture Forceps

CODE	DESCRIPTION	LENGTH
60-1638	Castroviejo 0.12 mm 1 x 2 Teeth with Platform	4 ¼ in 10.8 cm
60-1639	Castroviejo 0.3 mm 1 x 2 Teeth with Platform	4 ¼ in 10.8 cm
60-1635	Castroviejo 0.5 mm 1 x 2 Teeth with Platform	4 ¼ in 10.8 cm



60-1638

Forceps

Colibri Titanium Forceps

CODE	DESCRIPTION	LENGTH
60-5315	Angled Tips	3½ in 8.5 cm

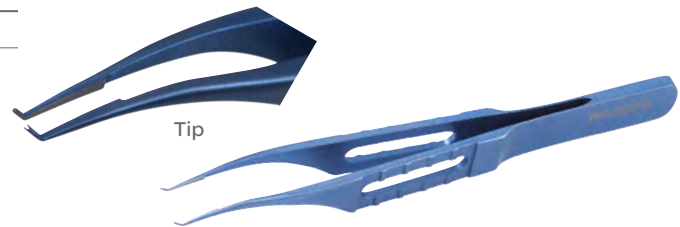

Colibri Tying Forceps

6.0 mm, Tying Platform

CODE	DESCRIPTION	LENGTH
60-1467	6.0 mm with Platform, 0.12 mm, Angled 45°	4½ in 10.5 cm

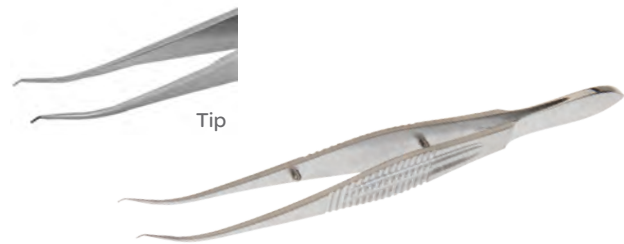

Desmarres Chalazion Forceps

Locking Thumb Screw, Smooth Blade

CODE	DESCRIPTION	LENGTH
60-1711	Small	3½ in 9.0 cm
60-1718	Medium	3½ in 9.0 cm

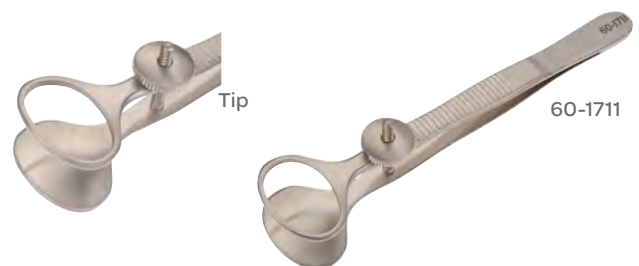

Dodick Nucleus Splitter

CODE	DESCRIPTION	LENGTH
60-1583	Serrated Paddle Jaws	4½ in 10.5 cm



Drews Cilia Forceps

CODE	DESCRIPTION	LENGTH
60-1701	4.0 mm Tips	4½ in 10.5 cm



Forceps

Ehrhardt Lid Forceps

Straight 9.0 mm Serrated Upper Jaw

CODE	DESCRIPTION	LENGTH
60-5530	14 mm Oval Lower Plate	4 in 10 cm

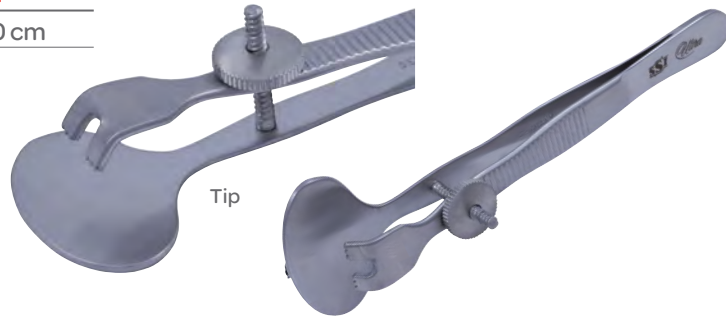

Elschnig Fixation Forceps

CODE	DESCRIPTION	LENGTH
60-1541	Heavy, 1 x 2 Angled Teeth	4 1/4 in 10.8 cm



Elschnig Fixation Forceps

CODE	DESCRIPTION	LENGTH
60-1542	1 x 2 Teeth with Catch	4 3/8 in 11.11 cm



Francis Chalazion Forceps

Inside Dimensions, 12 x 14 mm Long, Locking Thumb Screw

CODE	DESCRIPTION	LENGTH
60-1712	Smooth Blade	3 3/4 in 9.52 cm



Forceps

Gills Iris Forceps

Slightly Curved

CODE	DESCRIPTION	LENGTH
60-1510	1 x 2 Teeth	2¾ in 7.0 cm
60-1511	Cross-Serrated Tips	2¾ in 7.0 cm



60-1510

Gills-Welsh Capsule Forceps

CODE	DESCRIPTION	LENGTH
60-1496	Smooth Tips	2¾ in 7.0 cm

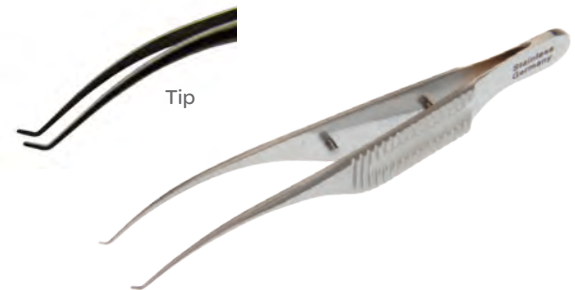

Girard Corneo-Scleral Forceps

Tying Platform

CODE	DESCRIPTION	LENGTH
60-1453	0.5 mm, Smooth Tips	4⅛ in 10.5 cm
60-1653	0.12 mm, 1 x 2 Teeth	4⅛ in 10.5 cm



60-1453

Girard Forceps

Round Handle

CODE	DESCRIPTION	LENGTH
60-1456	0.12 Left Hand	4¼ in 10.8 cm
60-1458	0.12 Right Hand	4¼ in 10.8 cm

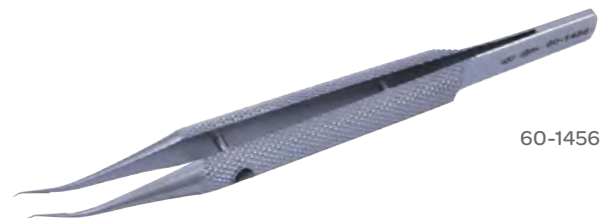

60-1456

Graefe Fixation Forceps

CODE	DESCRIPTION	LENGTH
60-1530	4.5 mm Jaw with Lock	4⅛ in 10.5 cm



Forceps

Graefe Iris Forceps

CODE	DESCRIPTION	LENGTH
60-1515	1x2 Teeth	2½ in 6.5 cm
60-1517	Straight Cross-Serrated Tips	2½ in 6.5 cm
60-1516	Curved Cross-Serrated Tips	2½ in 6.5 cm

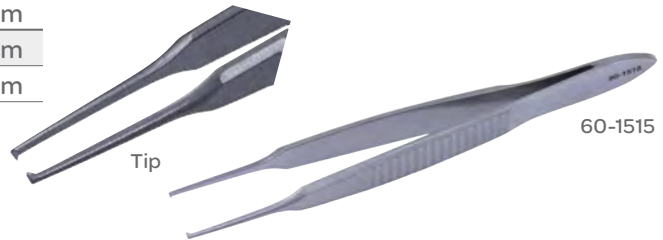

Harms-Tubingen Tying Forceps

CODE	DESCRIPTION	LENGTH
60-1612	Straight	4⅛ in 10.5 cm



Harms Utility Forceps

CODE	DESCRIPTION	LENGTH
60-1465	1x2 Teeth	3 in 7.5 cm

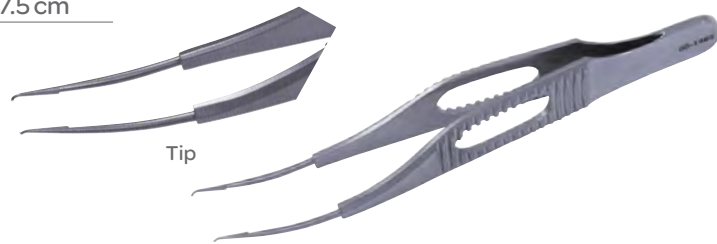

Hunt Chalazion Forceps

Open Smooth Blade, Locking Thumb Screw

CODE	DESCRIPTION
60-1714	12 mm Blade



Forceps

Jaffe-Castroviejo Suture Forceps

1 x 2 Teeth with Platform

CODE	DESCRIPTION	LENGTH
60-1621	0.12 mm	4 ¼ in 10.8 cm



Jaffe Tying Forceps

Very Delicate, Smooth Jaws, with Platform

CODE	DESCRIPTION	LENGTH
60-1608	Straight	4 in 10 cm
60-1609	Curved	4 in 10 cm



Jameson Muscle Forceps

12.0 mm Jaw, Slide Lock

CODE	DESCRIPTION	LENGTH
60-1664	Left	4 in 10 cm
60-1665	Right	4 in 10 cm

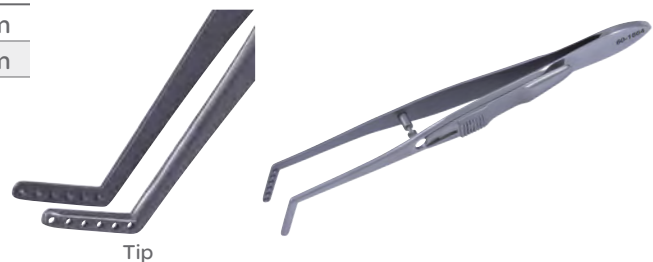

Tip

Jewelers Forceps

CODE	DESCRIPTION	STYLE	LENGTH
60-1683	With Tying Platform		4 ¾ in 12 cm
60-1689	Fine Point	Style 1	4 ¾ in 12 cm
60-1691	Straight, Extra Fine Point	Style 3	4 ¾ in 11.1 cm
60-1692	Straight, Extra Fine Point	Style 4	4 ¾ in 11.1 cm
60-1693	Straight, Extra Fine Point	Style 5	4 ¾ in 11.1 cm
60-1690	Straight, Extra Fine Point	Style 3	4 ½ in 11.5 cm
60-1695	Angled, Extra Fine Point	Style 5	4 ¾ in 11.1 cm
60-1694	Curved, Extra Fine Point	Style 7	4 ¾ in 11.1 cm



60-1690

Forceps

Kelman-McPherson Tying Forceps

Smooth Jaws, 7.5 mm Tying Platform

CODE	DESCRIPTION	LENGTH
60-1579	Angled	3 $\frac{1}{8}$ in 8.0 cm
60-1580	Angled, Very Delicate	3 $\frac{3}{4}$ in 9.5 cm



Kraff Capsule Tag Forceps

1.5 mm Smooth Platform

CODE	DESCRIPTION	LENGTH
60-1490	11 mm Angled Jaws	4 in 10 cm



Kratz Lens Holding Forceps

Very Delicate Narrow Jaws, Smooth, Slightly Curved

CODE	DESCRIPTION	LENGTH
60-1727	Without Lock	4 $\frac{1}{2}$ in 11.5 cm

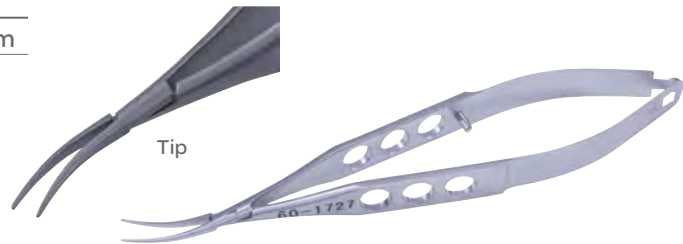

Kremer Fixation Forceps

CODE	DESCRIPTION
60-1552	Angled with Lock



Lambert Chalazion Forceps

CODE	DESCRIPTION	LENGTH
60-1716	Large, 12 mm Opening	3 $\frac{1}{2}$ in 9.0 cm



Forceps

Lehner-Utrata Capsulorhexis Forceps

CODE	DESCRIPTION	LENGTH
60-1494	Flat Handle, Vaulted Shafts	4 in 10 cm



Lester Fixation Forceps

CODE	TEETH	LENGTH
60-1534	1x2	3 3/4 in 9.5 cm
60-1535	2x3	3 3/4 in 9.5 cm



Maumenee Corneal Forceps

CODE	DESCRIPTION	LENGTH
60-1470	90° Angle	4 3/4 in 12 cm



McCullough Utility Forceps

CODE	DESCRIPTION	LENGTH
60-1680	Smooth Jaws	3 3/4 in 9.5 cm



Masket Capsulorhexis Forceps

CODE	JAWS	LENGTH
60-1553	11 mm	4 1/4 in 10.8 cm



Forceps

McPherson Tying Forceps

CODE	DESCRIPTION	LENGTH
60-1596	Straight	3 1/8 in 8.0 cm
60-1592	Angled	3 1/8 in 8.0 cm



60-1592

Nugent Utility Forceps

10 mm Jaws, Angled 45°

CODE	DESCRIPTION	LENGTH
60-1673	Smooth Jaws	4 1/8 in 10.5 cm
60-1674	Serrated Jaws	4 1/8 in 10.5 cm



60-1673

O'Gawa Tying Forceps

CODE	DESCRIPTION	LENGTH
60-1590	5.5 mm Platform	4 1/4 in 10.8 cm



Tip

O'Gawa Tying Forceps

Smooth, 0.5 mm Platform, 0.3 mm Gap at Heel of Platform

CODE	DESCRIPTION	LENGTH
60-1605	Straight	4 1/2 in 11.5 cm
60-1606	Curved	4 1/2 in 11.5 cm



Tip

60-1605

Paufique Forceps

CODE	DESCRIPTION	LENGTH
60-1651	1 x 2 Strong Teeth, with Platform	3 1/2 in 9.0 cm



Tip

Forceps

Sauer Suture Forceps

CODE	DESCRIPTION	LENGTH
60-1650	1 x 2 Teeth at Oblique Angled To Shaft	3½ in 9.0 cm



Schaff Foreign Body Forceps

CODE	DESCRIPTION	LENGTH
60-1696	Grooved Jaw	4¼ in 10.5 cm



Sheets-McPherson Tying Forceps

CODE	DESCRIPTION	LENGTH
60-1577	Angled, 10 mm Tying Platform, Cross-Serrated Tips	3¼ in 8.0 cm

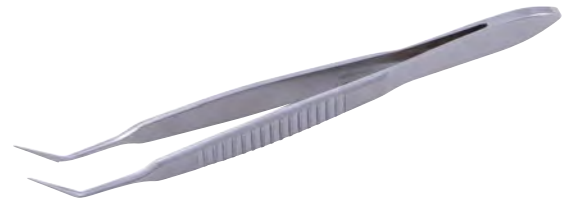

Sinsky Tying Forceps

CODE	DESCRIPTION	LENGTH
60-1598	Straight, Micro Tip with 7.0 mm Tying Platform	4¼ in 10.8 cm



Stern-Castroviejo Forceps

With Lock

CODE	DESCRIPTION	LENGTH
60-1633	Straight, 0.5 mm Teeth with Platform	4¾ in 11.1 cm



Forceps

Suture Tying Forceps

Round Handle

CODE	DESCRIPTION	LENGTH
60-1352	Straight	4 ³ / ₄ in 12 cm
60-1353	Curved	4 ³ / ₄ in 12 cm



60-1352

Utrata Titanium Capsulorhexis Forceps

CODE	DESCRIPTION	LENGTH
60-5150	Flat Handle	4 in 10 cm

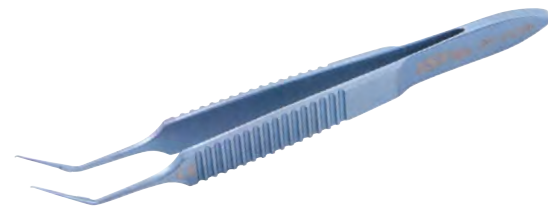

Titanium Nordan Tying Forceps

CODE	DESCRIPTION	LENGTH
60-5340	Straight	4 ¹ / ₂ in 11.5 cm
60-5342	Curved	4 ¹ / ₂ in 11.5 cm



60-5340

Titanium Tying Forceps

Flat Handle, Straight

CODE	DESCRIPTION	LENGTH
60-9201T	7.0 mm Platform	4 ¹ / ₂ in 11.5 cm

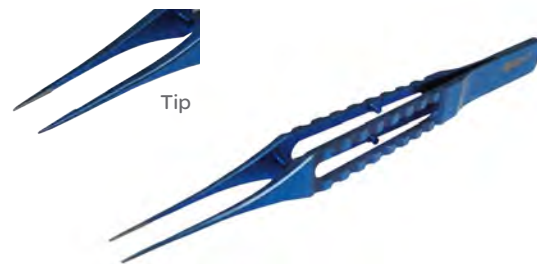

Tip

Thorpe Conjunctival Fixation Forceps

2 x 3 Teeth with Platform

CODE	TEETH	LENGTH
60-1544	0.6 mm	3 ³ / ₄ in 9.5 cm



Tip

Forceps

Titanium Capsulorhexis Utrata Forceps

CODE	DESCRIPTION
60-5149	Flat Handle

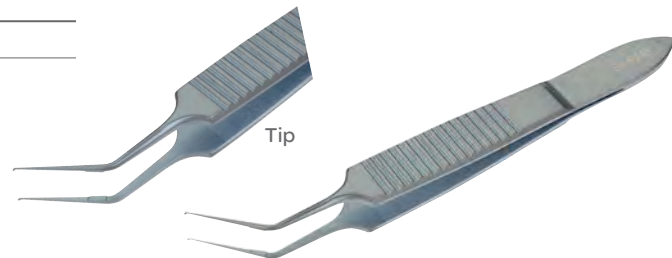

Tennant Tying Forceps

6.0 mm, Smooth Platform

CODE	DESCRIPTION	LENGTH
60-1619	Straight	4 in 10 cm
60-1618	Curved	4 in 10 cm



Titanium Tennant Tying Forceps

With Guide Pin and Platform

CODE	DESCRIPTION	LENGTH
60-5325	Straight	4 in 10 cm
60-5326	Curved	4 in 10 cm

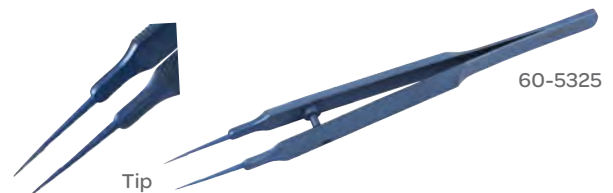

Troutman-Barraquer Corneal Utility Forceps

0.12 mm Teeth

CODE	DESCRIPTION	LENGTH
60-1462	With Platform, Very Delicate	3 in 7.5 cm
60-1463	Without Platform	3 in 7.5 cm



Watzke Sleeve Spreading Forceps

Angled 30°

CODE	DESCRIPTION	LENGTH
60-1732	Serrated 10 mm Tips	4 ½ in 11.5 cm



Forceps

Wills Hospital Utility Forceps

CODE	DESCRIPTION	LENGTH
60-1675	13 mm Platform With Cross-Serrations	4 1/8 in 10.5 cm



Ultra™ Titanium Tying Forceps

CODE	DESCRIPTION	LENGTH
60-5400	Straight, with Tying Platform	3 3/8 in 8.57 cm

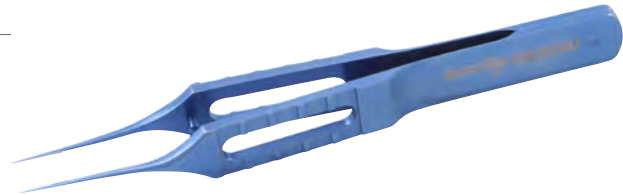

University Of Kansas Corneal Forceps

Colibri Style 2 x 2 Teeth, 7.0 mm Tying Platform

CODE	DESCRIPTION	LENGTH
60-1471	0.12 mm Teeth, Angled 45°	4 1/8 in 10.5 cm



Utrata Capsulorhexis Forceps

12 mm, Long Angled Jaws with Iris Stop

CODE	DESCRIPTION	LENGTH
60-1499	Round Handle, Extra Delicate 0.5 mm Pad at Distal Tips	4 1/4 in 10.8 cm
60-1492	Flat Handle	4 1/4 in 10.8 cm



Utrata Capsulorhexis Forceps

CODE	DESCRIPTION	LENGTH
60-1492S	Forceps	3 1/2 in 9.0 cm



Gauges

Mendez Degree Gauge

CODE	DESCRIPTION
60-7086	12 mm Inner Diameter

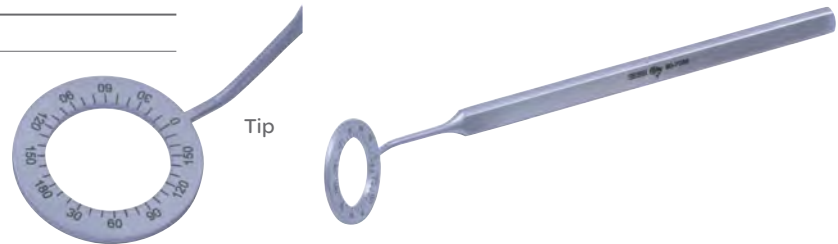

Hooks

Bonn Iris Hook

CODE	DESCRIPTION	LENGTH
60-1324	Curved, 3.0 mm Hook	5 in 12.5 cm



Bechert Lens Nucleus Rotator

CODE	DESCRIPTION	LENGTH
60-1118	Fork on Front	5 in 12.5 cm



Committed to Customer Service

Symmetry Surgical's Customer Service team of professionals is dedicated to providing our customers with world-class support, service and expertise. We strive to meet and exceed all expectations – and we consider our customers to be part of our extended family. Each team member has multi-faceted roles and is trained to answer questions about each of our diverse product lines.

Hooks

Clayman Iris Hook

CODE	DESCRIPTION	LENGTH
60-1319	Angled 45°, 9.0 mm from Tip to Angle	4 1/8 in 10.5 cm



Clayman-Jaffe Lens Manipulating Hook

CODE	DESCRIPTION	LENGTH
60-1309	Angled 45°, 9.0 mm Shaft with 0.2 mm Hook	4 3/4 in 12 cm



Crawford (Benger) Retrieving Hook

CODE	DESCRIPTION
60-1988	Retrieving Hook



Connor Wand

CODE	DESCRIPTION	LENGTH
60-2328	Straight	4 1/2 in 11.5 cm
60-1328	Angled	4 1/2 in 11.5 cm

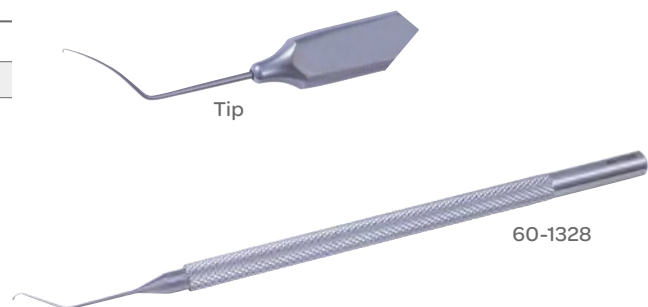

Hooks

Double Fixation Hook

CODE	DESCRIPTION	LENGTH
60-1298	1.5 mm Between Tips	5 1/8 in 13 cm
60-1299	2.0 mm Between Tips	5 1/8 in 13 cm

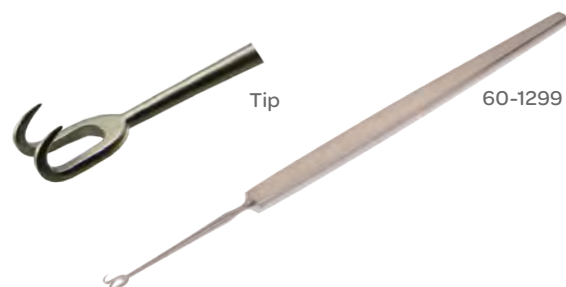

Galand Lens Manipulating Hook

CODE	DESCRIPTION
60-1123	Angled

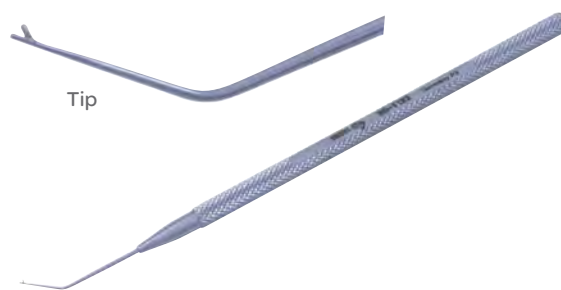

Gass Retinal Detachment Hook

CODE	DESCRIPTION	LENGTH
60-4991	Retinal Detachment Hook	5 3/4 in 14.5 cm

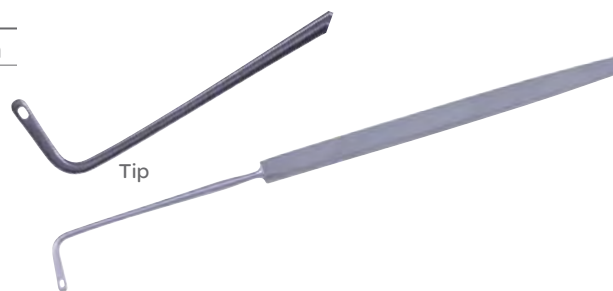

Hirschman Iris Hook

CODE	DESCRIPTION	LENGTH
60-1326	Angled, 0.75 mm Hook	4 3/4 in 12 cm



Hooks

Jameson Muscle Hook

CODE	DESCRIPTION	LENGTH
60-1340	Small	5 1/8 in 13 cm
60-1339	Large	5 1/8 in 13 cm

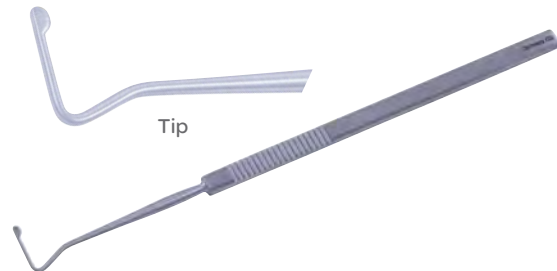

Leiske-Smith Lens Pusher

CODE	DESCRIPTION	LENGTH
60-1128	U-Shaped Tip	4 1/2 in 11.5 cm



Lester Hook

CODE	DESCRIPTION
60-1334	Modified

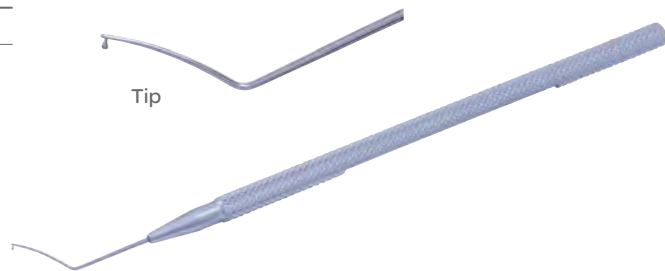

Lester Lens Pusher

0.25 mm Diameter, Hourglass Tip

CODE	DESCRIPTION	LENGTH
60-1126	Straight	4 1/2 in 11.5 cm
60-1127	Angled	4 1/2 in 11.5 cm



Hooks

Lewicky Lens Manipulating Hook

CODE	DESCRIPTION	LENGTH
60-1306	Curved, 9.0 mm Shaft, 90° Angled, 2.0 mm Tip	4½ in 11.5 cm



Maltzman-Fenzl Lens Manipulating Hook

CODE	DESCRIPTION	LENGTH
60-1311	Angled, 0.15 mm V-Shaped Tip	4¾ in 12 cm

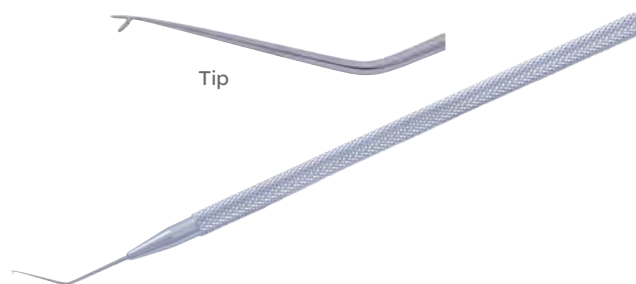

Manson Double Hook

CODE	DESCRIPTION
60-1349	Double Hook

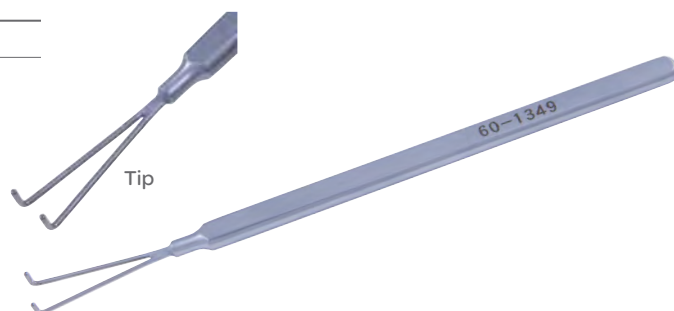

Nagahara Nucleus Chopper

CODE	DESCRIPTION	LENGTH
60-1114	Left	4½ in 11.5 cm
60-1115	Right	4½ in 11.5 cm

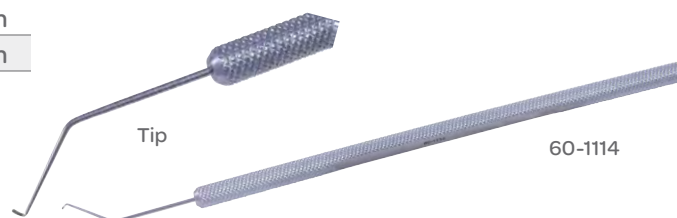

Hooks

Osher "Y" Hook

CODE	DESCRIPTION	LENGTH
60-1307	"Y" Hook	4 ³ / ₄ in 12 cm

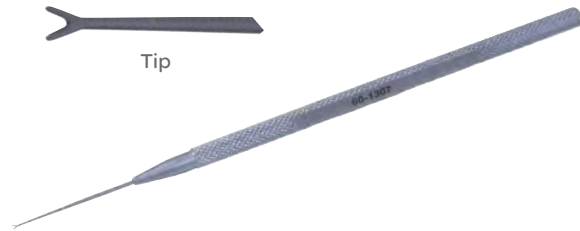

Sinskey II Lens Manipulating Hook

0.25 mm Blunt Tip, Round Handle

CODE	DESCRIPTION	LENGTH
60-1363	Straight	4 ¹ / ₂ in 11.5 cm

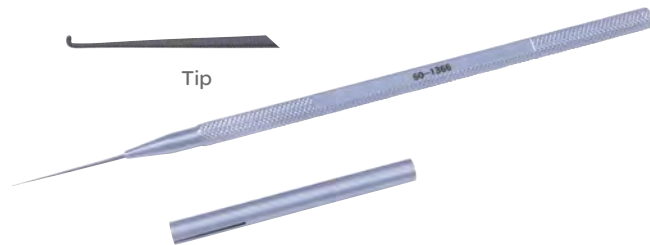

Sinskey II Lens Manipulating Hook

0.2 mm Blunt Tip, Round Handle

CODE	DESCRIPTION	LENGTH
60-1366	Straight	4 ¹ / ₂ in 11.5 cm
60-1367	Angled	4 ¹ / ₂ in 11.5 cm



Sinskey Iris Lens Manipulating Hook

Blunt Tip, 2.0 mm Diameter

CODE	DESCRIPTION
60-1310	Straight
60-1310A	Angled

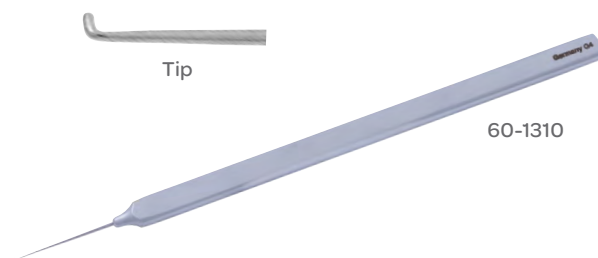

Hooks

Stevens Tenotomy Hook

CODE	DESCRIPTION	LENGTH
60-1348	6.0 mm Curved Hook	4 ³ / ₄ in 12 cm



Twist Fixation Hook

CODE	DESCRIPTION	LENGTH
60-1300	Right, 0.5 mm	4 ¹ / ₄ in 10.8 cm

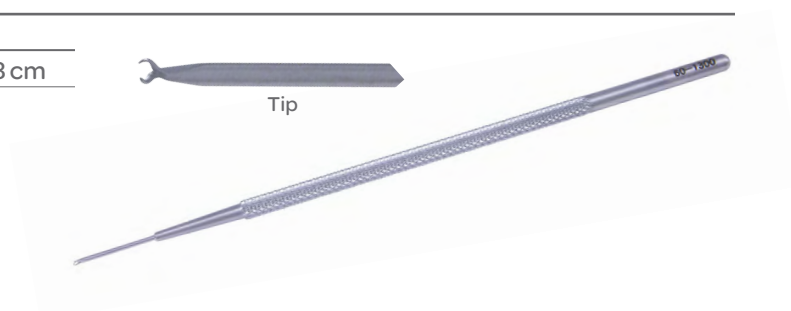

Sheets Iris Hook

CODE	DESCRIPTION	LENGTH
60-1327	3.0 mm Hook with Guard	5 ¹ / ₈ in 13 cm

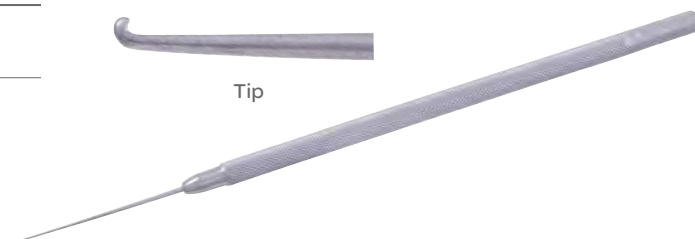

Titanium Kuglen Push/Pull Hook

CODE	DESCRIPTION
60-9516T	Push/Pull Hook



Von Graefe Strabismus Hook

CODE	DESCRIPTION	LENGTH
60-1344	#1, 1.0 x 5.0 mm	5 ¹ / ₄ in 13.5 cm
60-1346	#3, 2.0 x 11 mm	5 ³ / ₄ in 14.5 cm



60-1344

Introducers

Fox Sphere Introducer

CODE	DESCRIPTION	LENGTH
60-3023	Sphere Introducer	4 ⁷ / ₈ in 12.4 cm



Intubation Sets

Catalano Intubation Set

CODE	DESCRIPTION
60-1992	Intubation Set

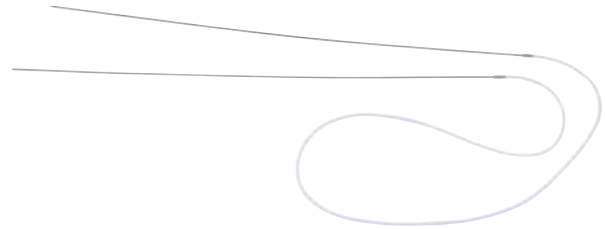

Crawford Lacrimal Intubation Set

CODE	DESCRIPTION
60-2014	Intubation Set

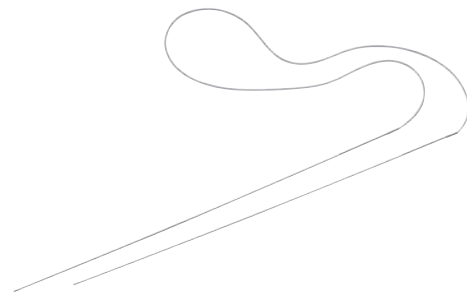

Jackson Lacrimal Intubation Set

CODE	DESCRIPTION
60-1990	Two 20-Gauge Thin Wall Probes (15.24) with 29.8 cm of Silicone Tubing Attached



Knives

Tooke Corneal Knife

CODE	DESCRIPTION	LENGTH
60-1045	Smooth, 3.0 x 18 mm Blade	4 ³ / ₄ in 12 cm



Lens Crackers

Titanium Salz Lens Cracker

CODE	DESCRIPTION
60-9155T	Splitter

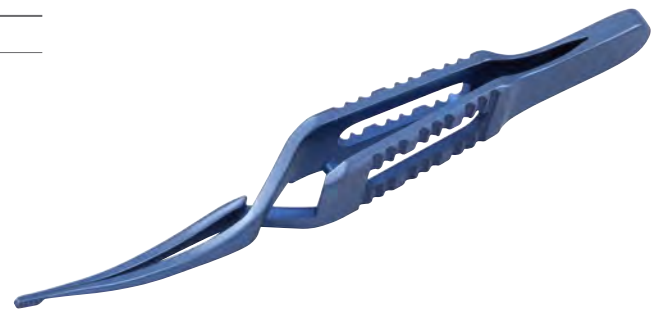

Simplifying Global Business

Symmetry Surgical understands the global marketplace and has a dedicated international team, including international customer service representatives, international business specialists, and international sales specialists. We have local representation through a network of authorized distributors or direct sales representatives in practically every nation.

If you would like more information on authorized sales agents in your country, please send your inquiry to InternationalOrders@symmetrysurgical.com.

Our international team is dedicated to supporting and managing the business efforts of our global customers and distributors—providing service that exceeds expectations.



Loops

Gills-Welsh Lens Loop

CODE	DESCRIPTION
60-1278	Lens Loop



Kirby Intra-Capsular Lens Loop

CODE	DESCRIPTION	LENGTH
60-1285	Long, Slender Loop	5½ in 14 cm

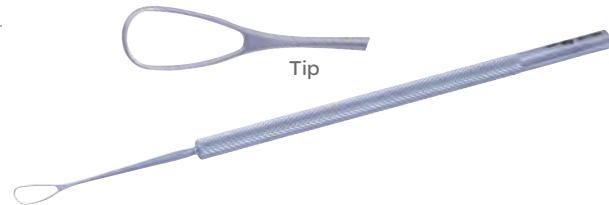

New Orleans Eye & Ear Lens Loop

CODE	DESCRIPTION	LENGTH
60-1281	Double-ended, 4.0 x 20 mm	5½ in 14 cm



Simcoe Lens Loop

CODE	DESCRIPTION	LENGTH
60-1280	Double-ended, Serrated Loops 4.0 x 15 x 20 mm	5½ in 14 cm



Wilder Lens Loop

CODE	DESCRIPTION	LENGTH
60-1275	Serrated, 4.0 x 15 mm Loop on Flat Handle	5½ in 14 cm



Manipulators

Drysdale Nucleus Manipulator

CODE	DESCRIPTION	LENGTH	
60-1119	Flattened Paddle Tip	4 in	10 cm

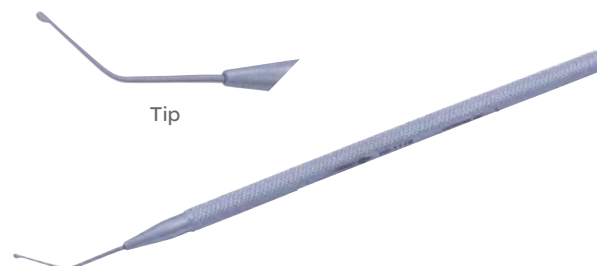

Bechert Lens Nucleus Rotator

CODE	DESCRIPTION	LENGTH	
60-1117	Angled, Blunt Forked Tip, 9.0 mm From Tip	4 ½ in	11.5 cm
60-1118	Fork on Front	5 in	12.5 cm

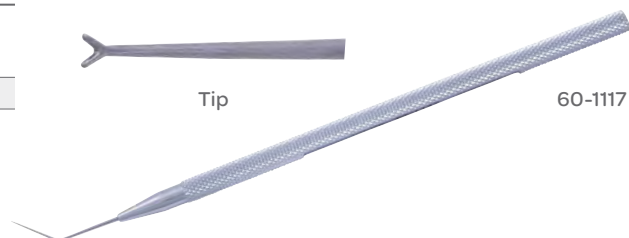

Jaffe-Maltzman Lens Manipulating Hook

CODE	DESCRIPTION	LENGTH	
60-1317	0.15 mm V-Shaped Angled Tip, Flat Handle	4 ¾ in	12 cm



Maloney No Hole IOL Manipulator

CODE	DESCRIPTION	LENGTH	
60-1333	Teardrop Shape Tip with Post	4 ¾ in	12 cm

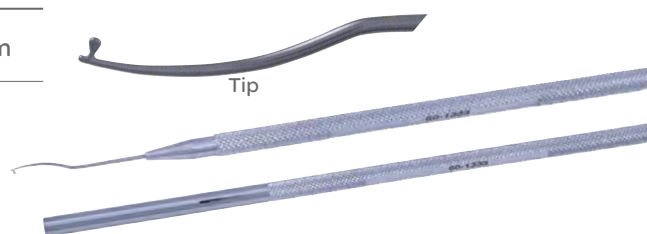

Manipulators

Harris-Sinskey Lens Manipulating Hook

CODE	DESCRIPTION	LENGTH
60-1369	Angled, 0.25 mm Diameter Blunt Tip	4 $\frac{1}{8}$ in 10.5 cm

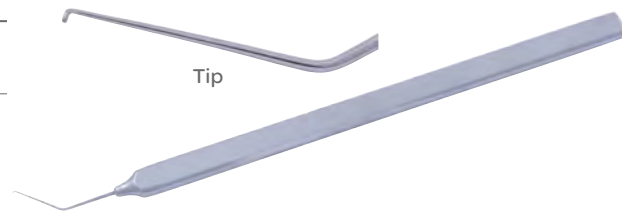

Osher Nucleus Manipulator

CODE	DESCRIPTION	LENGTH
60-1314	Blunt, Smaller than 60-1313, 0.5 mm, Two-Prong Tip	4 $\frac{3}{4}$ in 12 cm

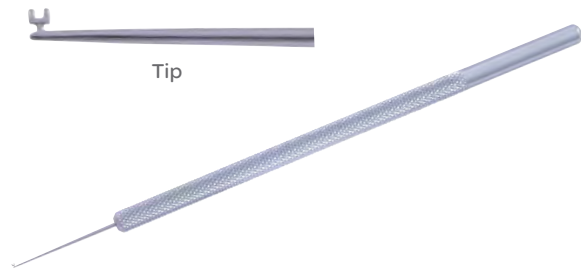

Tennant Nucleus Manipulator

CODE	DESCRIPTION	LENGTH
60-1125	Manipulator	4 $\frac{3}{4}$ in 12 cm

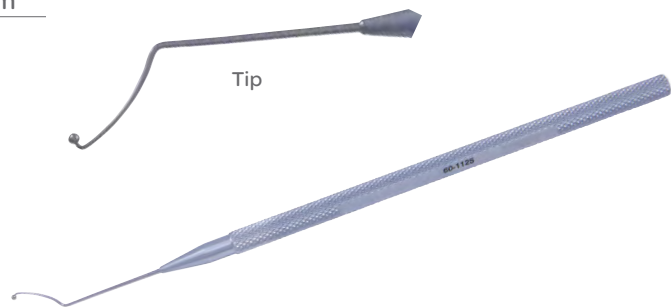

Markers

Bores Optic Zone Marker

CODE	DESCRIPTION	LENGTH	
60-7002	2.75 mm	3 ³ / ₄ in	9.5 cm
60-7010	4.75 mm	3 ³ / ₄ in	9.5 cm
60-7014	8.0 mm	3 ³ / ₄ in	9.5 cm

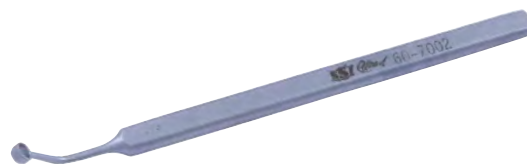

Bores Radial Marker

4.0 mm Center Opening, 9.5 mm Outer Diameter

CODE	DESCRIPTION
60-7051	6 Blades
60-7052	8 Blades

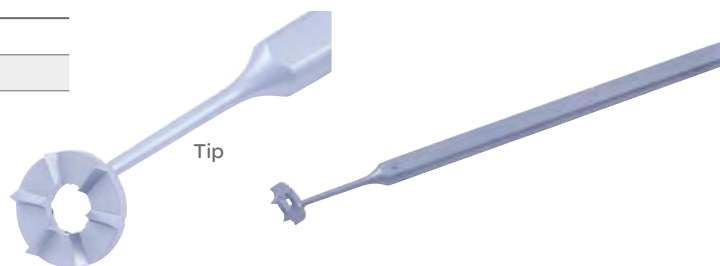

Osher-Neumann Corneal Marker

4 Blades

CODE	INNER DIAMETER	LENGTH	
60-8036	4.5 mm	4 ¹ / ₄ in	10.8 cm

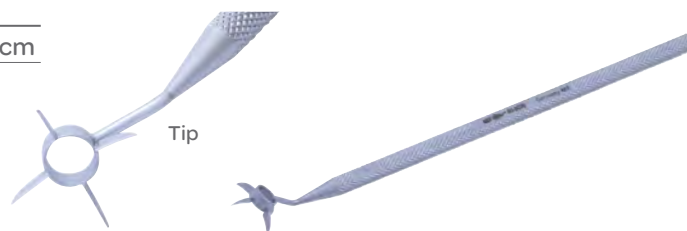

Thornton Optical Zone Marker

CODE	DESCRIPTION
60-7026	4 ³ / ₄ in 12 cm



Needles

Dix Needle & Gouge

Complete Set

CODE	DESCRIPTION
60-1434	Reversible Screw Handle

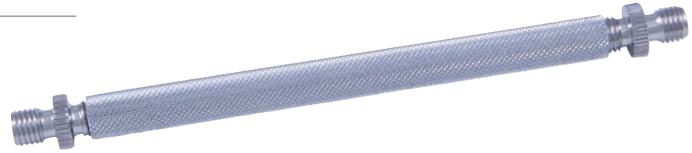

Maumenee Vitreous Aspirating Needle

CODE	DESCRIPTION
60-1151	Blunt Tip with Markings at 5.0 mm, 10 mm and 15 mm



Scheie Aspirating Cataract Needle

CODE	DESCRIPTION	GAUGE
60-1150	Sharp, Beveled Point	19 G



Wright Fascia Needle

CODE	DESCRIPTION
60-1018	Fascia Needle

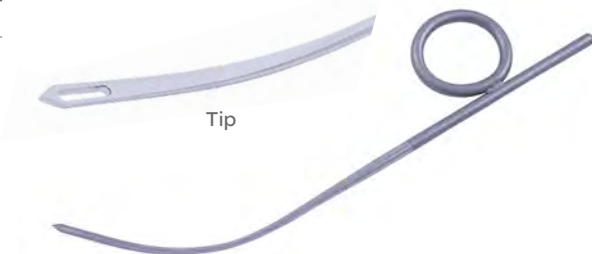

Needle Holders

Anis Needle Holder

Extra Delicate, 8.0 mm Jaws

CODE	DESCRIPTION	LENGTH
60-2801	Straight with Lock	5 in 12.5 cm
60-2803	Curved with Lock	5 in 12.5 cm



60-2801

Barraquer Needle Holder

Delicate Smooth Jaws, Round Handle

CODE	DESCRIPTION	LENGTH
60-1887	Straight with Lock	5 ¼ in 13.5 cm
60-1888	Straight without Lock	5 ¼ in 13.5 cm
60-1905	Straight with Lock, Delicate 8.0 mm Jaws	5 ¼ in 13.5 cm
60-1886	Curved without Lock	5 ¼ in 13.5 cm
60-1903	Curved without Lock, Delicate 8.0 mm Jaws	5 ¼ in 13.5 cm
60-1904	Curved with Lock, Delicate 8.0 mm Jaws	5 ¼ in 13.5 cm
60-1896	Curved without Lock, Delicate 10 mm Jaws	5 ¼ in 13.5 cm
60-1897	Curved with Lock, Delicate 10 mm Jaws	5 ¼ in 13.5 cm



Tip

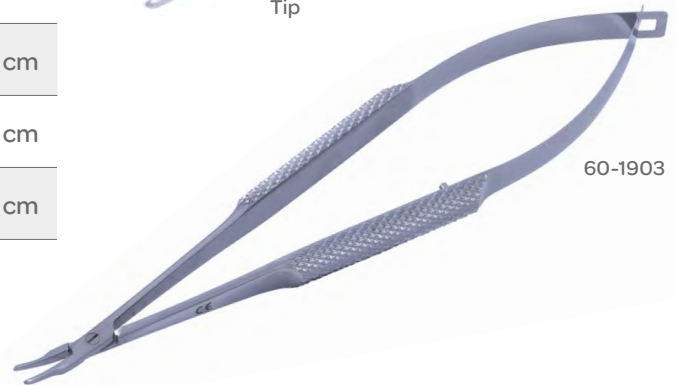

60-1903

Castroviejo Needle Holder

8.0 mm Wide Flat Handle, 10 mm Tips

CODE	DESCRIPTION	LENGTH
60-1910	Curved without Lock	5 ½ in 14 cm
60-1921	Straight without Lock	5 ½ in 14 cm



60-1910

Needle Holders

Castroviejo Needle Holder

CODE	DESCRIPTION	JAWS	LENGTH
60-1874	Straight with Lock, Round Handle	9.0 mm	4 ³ / ₄ in 12.0 cm
60-1918	Straight with Lock, Flat Wide Handle	Very Delicate 9.0 mm	5 ¹ / ₄ in 13.5 cm
60-1917	Straight with Lock, Flat Handle	Delicate 10 mm	5 ¹ / ₂ in 14 cm
60-1922	Straight with Lock, Flat Handle	14 mm	5 ⁷ / ₈ in 14.92 cm
60-1923	Straight without Lock, Flat Wide Handle	Very Delicate 9.0 mm	5 ¹ / ₄ in 13.5 cm
60-1921	Straight without Lock, Flat Handle	Delicate 10 mm	5 ¹ / ₂ in 14 cm
60-1919	Curved with Lock, Flat Wide Handle	Very Delicate 9.0 mm	5 ¹ / ₄ in 13.5 cm
60-1909	Curved with Lock, Flat Handle	Delicate 10 mm	5 ¹ / ₂ in 14 cm
60-1920	Curved without Lock, Flat Wide Handle	Very Delicate 9.0 mm	5 ¹ / ₄ in 13.5 cm
60-1910	Curved without Lock, Flat Handle	Delicate 10 mm	5 ¹ / ₂ in 14 cm



60-1917

Castroviejo Needle Holder

12 mm Jaws, Flat Handle, Standard Pattern

CODE	DESCRIPTION	LENGTH
60-1924	Straight with Lock	5 ³ / ₄ in 14.5 cm
60-1925	Curved with Lock	5 ³ / ₄ in 14.5 cm



60-1924

Needle Holders

Cohan Needle Holder

7.0 mm Jaws, Round Handles

CODE	DESCRIPTION	LENGTH
60-1895	Curved with Lock	4 in 10 cm
60-1894	Curved without Lock	4 in 10 cm



McPherson Needle Holder

Smooth 10 mm Tapered Jaw, Extra Delicate

CODE	DESCRIPTION	LENGTH
60-1892	Curved with Lock	4 7/8 in 10.5 cm



Titanium Barraquer Needle Holder

Medium Jaws

CODE	DESCRIPTION	LENGTH
60-5504	Straight with Lock	4 1/4 in 11 cm
60-5503	Straight without Lock	4 1/4 in 11 cm
60-5505	Curved with Lock	4 1/4 in 11 cm
60-5502	Curved without Lock	4 1/4 in 11 cm

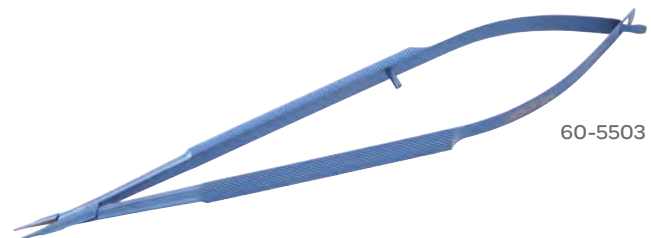

Titanium Micro Needle Holder

Smooth Jaws, Round Handles

CODE	DESCRIPTION	LENGTH
60-5510	Straight with Lock	5 in 12.5 cm
60-5509	Straight without Lock	5 in 12.5 cm
60-5511	Curved without Lock	5 in 12.5 cm

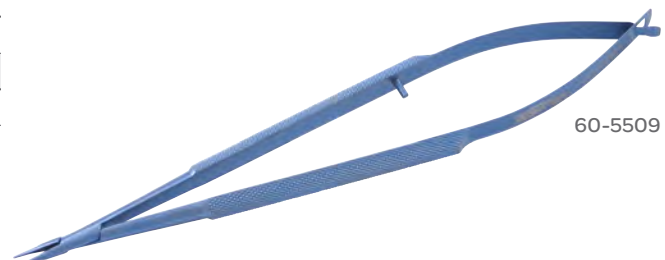

Needle Holders

Titanium Micro Needle Holder

Smooth Jaws, Round Handles

CODE	DESCRIPTION	LENGTH
60-5520	Straight without Lock	5 ³ / ₈ in 13.6 cm
60-5524	Curved with Lock	5 ³ / ₈ in 13.6 cm
60-5526	Curved without Lock	5 ³ / ₈ in 13.6 cm



60-5520

Troutman-Barraquer Needle Holder

Smooth Jaws, Round Handles

CODE	DESCRIPTION	LENGTH
60-1901	Angled with Lock	4 ¹ / ₂ in 11.5 cm
60-1902	Angled without Lock	4 ¹ / ₂ in 11.5 cm



60-1902

Troutman Needle Holder

Round Handles, 9.0 mm Jaws

CODE	DESCRIPTION	LENGTH
60-1900	Curved with Lock	4 ³ / ₄ in 12 cm
60-1899	Curved without Lock	4 ³ / ₄ in 12 cm



60-1899

Ultra™ Needle Holder

Conical 9.0 mm Jaws, Wide Handle

CODE	DESCRIPTION	LENGTH
60-1876	Straight without Lock	5 ³ / ₈ in 13.6 cm



60-1876

Plates

Berke-Jaeger Lid Plate

Sterling

CODE	DESCRIPTION	LENGTH
60-1070	$\frac{3}{8}$ in 10 mm	4 $\frac{1}{2}$ in 10.8 cm



Probes

Bowman Lacrimal Probe

Sterling

CODE	DESCRIPTION
60-1976	Size 0000-000
60-1977	Size 00-0
60-1978	Size 1-2
60-1979	Size 3-4
60-1980	Size 5-6
60-1981	Size 7-8

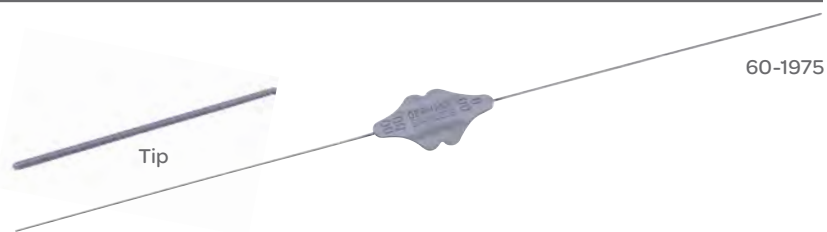

Pigtail Probe

With Suture Eyes Just Behind Blunt Ends

CODE	LENGTH
60-1989	6 in 15 cm



Quickert Lacrimal Intubation Probe

CODE	DESCRIPTION
60-2100	#00
60-2110	#0
60-2111	#1
60-2112	#2
60-2113	#3
60-2114	#4

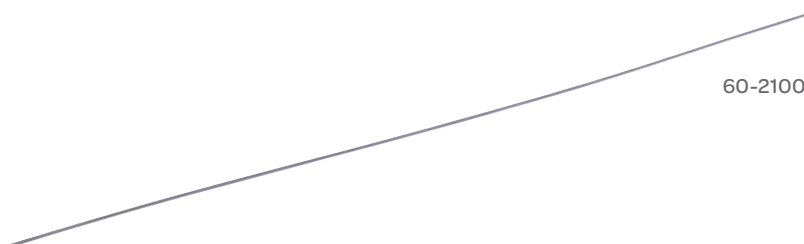

Probes

Williams Lacrimal Probe

Ball Tip, Sterling

CODE	DESCRIPTION
60-1982	Size 00-0
60-1983	Size 1-2
60-1984	Size 3-4
60-1985	Size 5-6
60-1986	Size 7-8

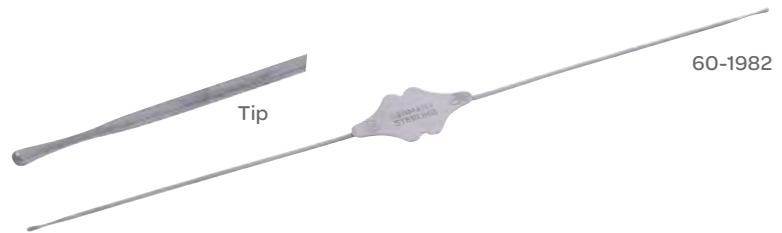

Retractors

Desmarres Lid Retractor

CODE	SIZE	WIDTH	LENGTH
60-1404	Size 0	11 mm	5½ in 14 cm
60-1405	Size 1	13 mm	5½ in 14 cm
60-1406	Size 2	15 mm	5½ in 14 cm
60-1407	Size 3	16 mm	5½ in 14 cm
60-1403	Size 4	18 mm	5½ in 14 cm



Graether Collar Button

CODE	DESCRIPTION	LENGTH
60-1388	Angled, 23 Gauge	1 in 2.54 cm



Graether Collar Button on Handle

CODE	DESCRIPTION	LENGTH
60-1389	Straight	4¾ in 12 cm
60-1390	Angled	4¾ in 12 cm

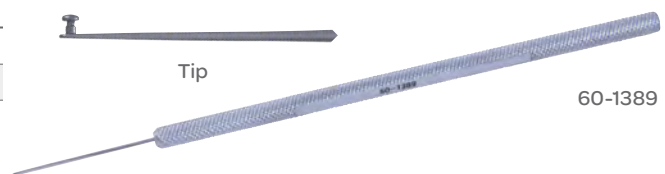

Retractors

Jaffe Lid Retractor

Set of Two

CODE	DESCRIPTION
60-1408	9.0 mm Wide

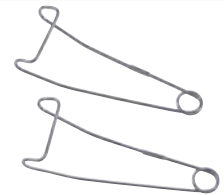

Rizzuti Expressor & Iris Retractor

CODE	DESCRIPTION
60-1394	3.0 mm



Rollet Lacrimal Sac Retractor

CODE	DESCRIPTION	LENGTH
50-6536	Four Prong, Sharp	5¼ in 13.3 cm



Schepens Orbital Retractor

CODE	DESCRIPTION	LENGTH
60-5008	Smooth 14 x 57 mm Blade with Notched End, 4.5 mm Wide Notch	6 in 15 cm

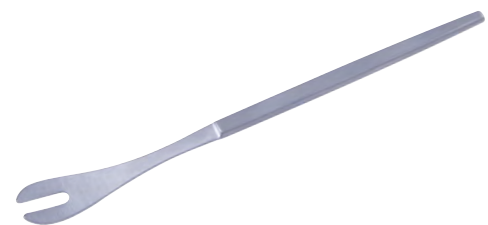

Stevenson Lacrimal Sac Retractor

CODE	DESCRIPTION	LENGTH
60-1413	Curved Teeth, 1.0 x 5.0 mm, Spread 20 mm	3½ in 9.0 cm



Rings

Fine-Thornton Swivel Ring

CODE	DESCRIPTION
60-7065	13 mm

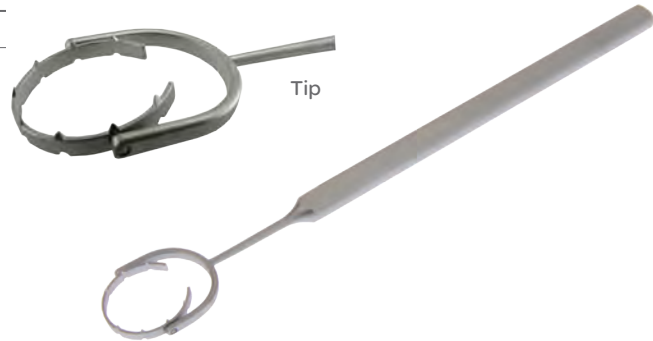

Flieringa Fixation Ring

CODE	DESCRIPTION
60-3015	15 mm Diameter
60-3017	17 mm Diameter
60-3022	22 mm Diameter

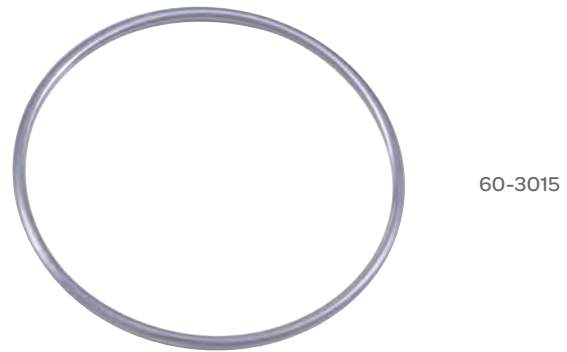

Thornton Fixation Ring

16 mm Ring with Multiple Teeth

CODE	DESCRIPTION	LENGTH
60-7000		4 3/4 in 12 cm
60-7001	Swivel Handle	4 3/4 in 12 cm

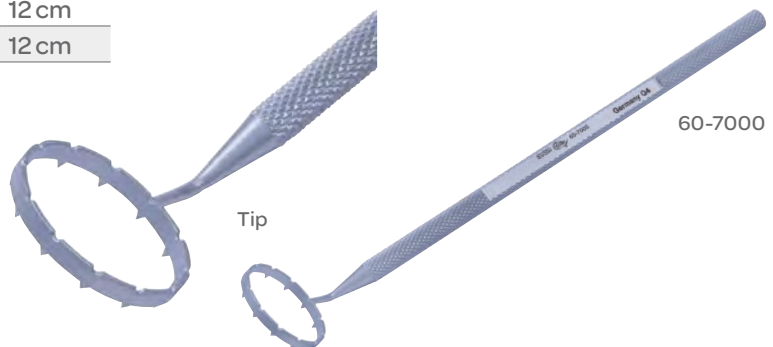

Rotators

Pisacano Nucleus Rotator

CODE	DESCRIPTION
60-1013	Horizontal Flat Disc Shaped Tip

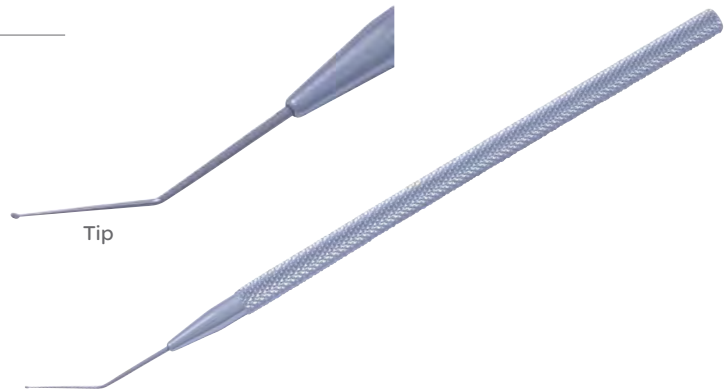

Bechert-Hoffer Nucleus Rotator

CODE	DESCRIPTION
60-1116	$\frac{3}{8}$ in 10 mm

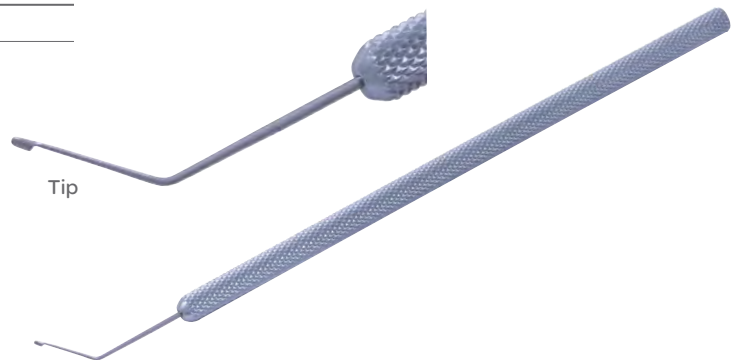

Scissors

Aebli Corneal Scissors

Delicate, Blunt Tips

CODE	DESCRIPTION	LENGTH
60-1773	Angled Right	4½ in 11.5 cm
60-1774	Angled Left	4½ in 11.5 cm



60-1773

Barraquer Iris Scissors

Delicate, Blunt Blades

CODE	BLADES	LENGTH
60-1821	7.0 mm	2 in 5.0 cm
60-1831	10 mm	2 in 5.0 cm



60-1821

Castroviejo Corneal Scissors

Miniature, Blunt Tips

CODE	DESCRIPTION	LENGTH
60-1752	Angled Left	4⅛ in 10.5 cm
60-1753	Angled Right	4⅛ in 10.5 cm

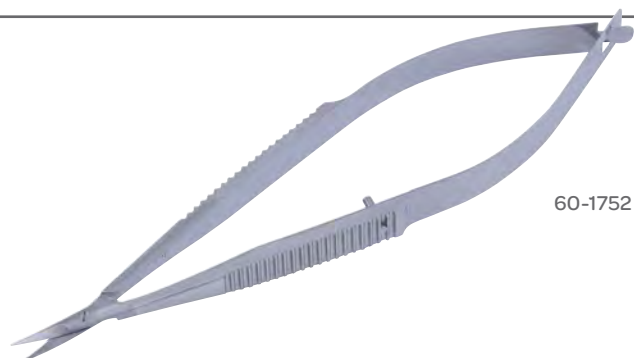

60-1752

Castroviejo Corneal Scissors

Medium Pattern, Blunt Tips

CODE	DESCRIPTION	LENGTH
60-1754	Strongly Curved	4½ in 11.5 cm



Scissors

Castroviejo Corneal Scissors

Delicate, Blunt Tips

CODE	DESCRIPTION	LENGTH
60-1756	Angled	4 $\frac{1}{8}$ in 10.5 cm



Castroviejo Corneal Section Scissors

Micro Pattern, Lower Blade 6.0 mm, Upper Blade 5.5 mm, Blunt Tips

CODE	DESCRIPTION	LENGTH
60-1786	Curved Right	4 $\frac{1}{4}$ in 10.8 cm
60-1787	Curved Left	4 $\frac{1}{4}$ in 10.8 cm



Castroviejo Corneal Section Scissors

Lower Blade 14 mm, Upper Blade 13 mm

CODE	DESCRIPTION	LENGTH
60-1776	Curved Right	4 $\frac{1}{4}$ in 10.8 cm
60-1779	Curved Left	4 $\frac{1}{4}$ in 10.8 cm

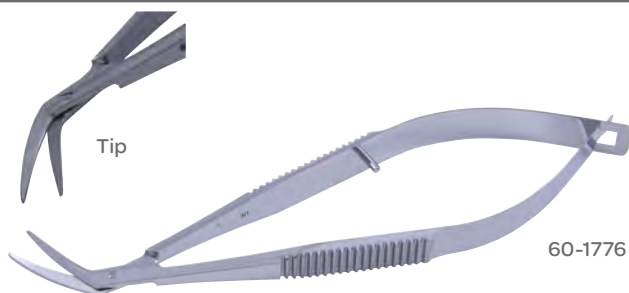

Castroviejo Corneal Scissors

Curved Blunt Tips

CODE	BLADES	LENGTH
60-1768	12 mm	4 in 10 cm
60-1770	7.0 mm	4 in 10 cm



Scissors

Castroviejo Keratoplasty Scissors

Lower Blade 1.0 mm, Longer Than Upper Blade

CODE	DESCRIPTION	LENGTH
60-1855	Blunt Angled Blades, Probe Tip	4 ¼ in 10.8 cm



Castroviejo Keratoplasty Scissors

Miniature Pattern, Blunt Tips, Wide Handle

CODE	DESCRIPTION	LENGTH
60-1755	Slightly Curved	5 ¼ in 13.5 cm



Castroviejo Micro Scissors

Round Handle, Sharp Delicate Blades

CODE	DESCRIPTION	LENGTH
55-8049	Angled 25°	4 ½ in 11.5 cm
55-8050	Angled 45°	4 ½ in 11.5 cm
55-8051	Angled 60°	4 ½ in 11.5 cm
55-8053	Angled 125°	4 ½ in 11.5 cm



Castroviejo Corneal Section Scissors

Medium Pattern, Wide Handle

CODE	DESCRIPTION	LENGTH
60-1784	Right	4 ½ in 10.5 cm
60-1783	Left	4 ½ in 10.5 cm



Scissors

Dissecting Scissors

With Ball Tip

CODE	DESCRIPTION	LENGTH
02-5063	Curved	4 1/8 in 10.5 cm
02-5065	Angled	4 1/8 in 10.5 cm



Dissecting Scissors

With Probe

CODE	DESCRIPTION	LENGTH
02-5062	Straight	4 in 10 cm



Enucleation Scissors

CODE	DESCRIPTION	LENGTH
60-1749	Light Curve	5 1/2 in 14 cm
60-1750	Medium Curve	5 1/2 in 14 cm
60-1751	Strong Curve	5 1/2 in 14 cm



Gills-Vannas Capsulotomy Scissors

Extra Thin Long Blades, Sharp Tips

CODE	DESCRIPTION	LENGTH
60-1862	Straight	3 3/8 in 8.5 cm
60-1863	Curved	3 3/8 in 8.5 cm
60-1864	Angled forward	3 3/8 in 8.5 cm



Scissors

Iris Classic Plus® Scissors

Stellite Edge Inserts, Sharp/Sharp

CODE	DESCRIPTION	LENGTH
34-6500	Straight	4 ³ / ₈ in 11.1 cm
34-6503	Curved	4 ³ / ₈ in 11.1 cm



34-6500

Iris Classic® Scissors

Sharp/Sharp

CODE	DESCRIPTION	LENGTH
36-5000	Straight	4 ¹ / ₂ in 11.4 cm
36-5001	Curved	4 ¹ / ₂ in 11.4 cm



36-5000

Iris Scissors

Standard Pattern

CODE	DESCRIPTION	LENGTH
02-2009	Straight	3 ⁵ / ₈ in 9.2 cm
02-2010	Straight	4 ⁵ / ₈ in 11.7 cm
02-2011	Straight	4 ¹ / ₂ in 11.5 cm
02-2012	Straight	5 in 12.5 cm
02-2109	Curved	3 ¹ / ₂ in 9.0 cm
02-2110	Curved	4 ¹ / ₈ in 10.5 cm
02-2111	Curved	4 ¹ / ₂ in 11.5 cm
02-2112	Curved	5 in 12.5 cm



02-2009

Iris Scissors

Tungsten Carbide Inserts

CODE	DESCRIPTION	LENGTH
32-706	Straight	4 ¹ / ₂ in 11.5 cm
32-676	Straight, One Serrated Blade	4 ¹ / ₂ in 11.5 cm
32-705	Curved	4 ¹ / ₂ in 11.5 cm
32-675	Curved, One Serrated Blade	4 ¹ / ₂ in 11.5 cm



32-705

Scissors

Iris Scissors

Sharp Tips

CODE	DESCRIPTION	LENGTH
60-1814	Straight	4½ in 11.5 cm
60-1815	Curved	4½ in 11.5 cm



60-1814

Iris Scissors

Large Ribbon Ring Handles with Flat Shanks, Heavy Pattern, Blunt Tips

CODE	DESCRIPTION	LENGTH
60-1823	Straight	4 in 10 cm
60-1824	Curved	4 in 10 cm



60-1823

Iris Scissors

Large Ribbon Handles with Flat Shanks

CODE	DESCRIPTION	LENGTH
60-1825	Straight	4 in 10 cm
60-1826	Curved	4½ in 10.5 cm



60-1825

Iris Scissors

Delicate, Large Ring Handles

CODE	DESCRIPTION	LENGTH
60-1827	Straight	4 in 10 cm
60-1828	Curved	4 in 10 cm



60-1827

Iris Scissors

Standard Pattern

CODE	DESCRIPTION	LENGTH
60-1829	Straight	4 in 10 cm
60-1830	Curved	4 in 10 cm



60-1829

Scissors

Iris Scissors

Large Ribbon Handles with Flat Shanks

CODE	DESCRIPTION	LENGTH
60-1843	Straight, Sharp Tips	4 in 10 cm
60-1845	Straight, Blunt Tips	4 in 10 cm
60-1844	Curved, Sharp Tips	4 in 10 cm
60-1846	Curved, Blunt Tips	4 in 10 cm



60-1843

Iris Scissors

Standard Pattern

CODE	DESCRIPTION	LENGTH
60-1847	Straight	4 1/8 in 10.5 cm
60-1848	Curved	4 1/8 in 10.5 cm



60-1847

Iris Scissors

Micro-Miniature Pattern, 8.0 mm Blades

CODE	DESCRIPTION	LENGTH
60-1852	Straight	4 in 10 cm
60-1854	Curved	4 in 10 cm



60-1852

Jaffe Stitch Scissors

Very Sharp Tips, Medium Blades

CODE	DESCRIPTION	LENGTH
60-1817	Curved	4 1/8 in 10.5 cm



Katzin Corneal Transplant Scissors

Miniature Pattern, Upper Blade Shorter than Lower Blade

CODE	DESCRIPTION	LENGTH
60-1759	Strongly Curved Left	4 1/8 in 10.5 cm
60-1760	Strongly Curved Right	4 1/8 in 10.5 cm



60-1759

Scissors

Knapp Dissecting Scissors

CODE	DESCRIPTION	LENGTH
02-4010	Straight	4 $\frac{1}{16}$ in 10.3 cm
02-4110	Curved	4 $\frac{1}{16}$ in 10.3 cm



02-4010

Knapp Iris Scissors

CODE	DESCRIPTION	LENGTH
54-6524	Straight, Sharp/Blunt	4 in 10 cm
54-6526	Straight, Blunt/Blunt	4 in 10 cm
54-6525	Curved, Sharp/Blunt	4 in 10 cm
54-6527	Curved, Blunt/Blunt	4 in 10 cm



54-6524

Knapp Scissors

CODE	DESCRIPTION	LENGTH
02-2042	Straight, Sharp/Sharp	4 $\frac{3}{4}$ in 12 cm
02-2043	Straight, Blunt/Blunt	4 $\frac{3}{4}$ in 12 cm
02-2142	Curved, Sharp/Sharp	4 $\frac{3}{4}$ in 12 cm
02-2143	Curved, Blunt/Blunt	4 $\frac{3}{4}$ in 12 cm



02-2042

Knapp Strabismus Scissors

Rounded Blades

CODE	DESCRIPTION	LENGTH
60-1865	Straight, Blunt/Blunt	4 $\frac{1}{8}$ in 10.5 cm
60-1866	Curved, Blunt/Blunt	4 $\frac{1}{8}$ in 10.5 cm



60-1865

Ceramic Coated Iris Scissors

Ceramic Coated, Razor Edges and Micro Serrations

CODE	DESCRIPTION	LENGTH
222.20.61	Straight	4 $\frac{1}{2}$ in 11.5 cm
222.21.61	Curved	4 $\frac{1}{2}$ in 11.5 cm



222.20.61

Scissors

Ceramic Coated Stevens Tenotomy Scissors

Ceramic Coated, Razor Edges and Micro Serrations

CODE	DESCRIPTION	LENGTH
222.50.62	Straight	4 1/8 in 10.5 cm
222.50.63	Curved	4 1/8 in 10.5 cm
224.67.63	Curved	5 1/8 in 13 cm



McPherson-Vannas Iris Scissors

Miniature Pattern, Sharp Tips

CODE	DESCRIPTION	LENGTH
60-1816	Curved	3 1/3 in 8.5 cm



Micro Scissors

Wide Handle

CODE	DESCRIPTION	LENGTH
05-1220	Straight	5 in 12.5 cm
05-1230	Straight, Vannas-Type Cutting Blades 5.0 mm Blades	5 in 12.5 cm
05-1221	Curved	5 in 12.5 cm
05-1231	Curved, Vannas-Type Cutting Blades 5.0 mm Blades	5 in 12.5 cm



Razor Edge Iris Scissors

Black Handle without Serrations

CODE	DESCRIPTION	LENGTH
80-2010	Straight	4 1/2 in 11.5 cm
80-2011	Curved	4 1/2 in 11.5 cm



Scissors

Razor Edge Stevens Tenotomy Scissors

Black Handle without Serrations

CODE	DESCRIPTION	LENGTH	
80-5012	Straight	5 in	12.5 cm
80-5009	Curved	4½ in	11.5 cm
80-5013	Curved	5 in	12.5 cm



80-5012

Reynolds Dissecting Scissors

Tenotomy Tip, Delicate Pattern

CODE	DESCRIPTION	LENGTH	
04-6712	Curved	5 in	12.5 cm
04-6714	Curved	5⅝ in	14.3 cm



Stevens Serrated Tenotomy Scissors

With Black Handles

CODE	DESCRIPTION	LENGTH	
86-5012	Straight	4½ in	11.5 cm
86-5013	Curved	4½ in	11.5 cm



86-5012

Serrated Iris Scissors

With Black Handles

CODE	DESCRIPTION	LENGTH	
86-2011	Straight	4½ in	11.5 cm
86-2111	Curved	4½ in	11.5 cm



86-2011

Scissors

Shepherd-Westcott Tenotomy Scissors

20 mm from Screw to Tip, Blunt Tips

CODE	DESCRIPTION	LENGTH
60-1822	Curved	4 ⁷ / ₈ in 12.4 cm



Stern-Gills Scissors

CODE	DESCRIPTION
60-1869	10 mm Angled Forward

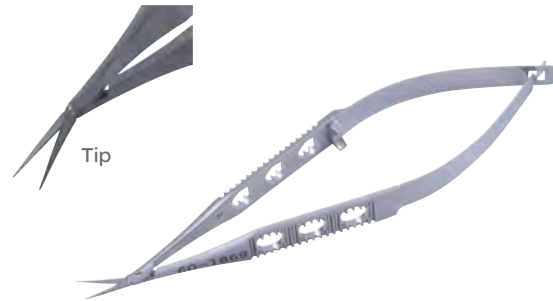

Stevens Tenotomy Scissors

Sharp Tips

CODE	DESCRIPTION	LENGTH
02-5002	Straight	4 in 10 cm
02-5003	Curved	4 in 10 cm



Stevens Tenotomy Scissors

Tungsten Carbide Inserts

CODE	DESCRIPTION	LENGTH
32-708	Straight	4 ¹ / ₂ in 11.5 cm
32-709	Curved	4 ¹ / ₂ in 11.5 cm



Scissors

Stevens Tenotomy Scissors

Blunt Tips

CODE	DESCRIPTION	LENGTH
02-5012	Straight	4 in 10 cm
60-1805	Straight	4½ in 11.5 cm
02-5013	Curved	4 in 10 cm
60-1806	Curved	4½ in 11.5 cm



02-5012

Stevens Tenotomy Scissors

Curved Heavy Pattern Blunt Tips

CODE	DESCRIPTION	LENGTH
60-1803	Large Ribbon Ring Handles with Flat Shanks	4 in 10 cm

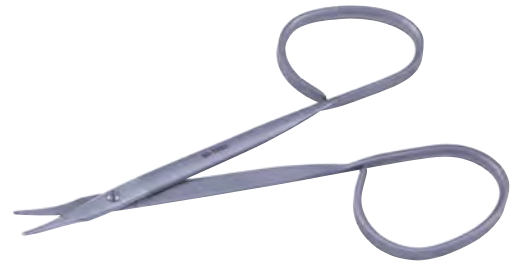

Stevens Tenotomy Scissors

Large Ribbon Ring Handles with Flat Shanks, Light Pattern

CODE	DESCRIPTION	LENGTH
60-1804	Straight, Blunt	4 in 10 cm
60-1807	Curved, Blunt	3¾ in 9.8 cm



60-1804

Stitch Scissors

Large Ribbon Ring Handles with Flat Shanks, Curved

CODE	DESCRIPTION	LENGTH
60-1813	Sharp, Delicate	3¾ in 9.5 cm
60-1812	Sharp, Extra Delicate	3¾ in 9.5 cm



60-1813

Scissors

Stitch Scissors

Sharp Tips, Fine Delicate Blades

CODE	DESCRIPTION	LENGTH
60-1810	Straight	4 ½ in 11.5 cm



Strabismus Scissors

Blunt Tips, Tungsten Carbide Inserts

CODE	DESCRIPTION	LENGTH
32-700	Curved	4 ½ in 11.5 cm
32-701	Straight	4 ½ in 11.5 cm



32-700

Strabismus Scissors

Ribbon Handles

CODE	DESCRIPTION	LENGTH
60-1856	Straight	4 ¼ in 10.8 cm
60-1857	Curved	4 ¼ in 10.8 cm



60-1856

Razor Edge Iris Scissors

Black Handle, Gold Screw, One Cutting Edge with Micro Serrations

CODE	DESCRIPTION	LENGTH
212.20.11	Straight	4 ½ in 11.5 cm
212.21.11	Curved	4 ½ in 11.5 cm



212.20.11

Scissors

Razor Edge Stevens Tenotomy Scissors

Black Handle, Gold Screw, One Cutting Edge with Micro Serrations

CODE	DESCRIPTION	LENGTH
212.50.12	Straight	4½ in 11.5 cm
212.50.13	Curved	4½ in 11.5 cm



212.50.13

Serrated Iris Scissors

CODE	DESCRIPTION	LENGTH
85-2010	Straight	4⅞ in 10.5 cm
85-2013	Straight	4½ in 11.5 cm
85-2015	Curved	4½ in 11.5 cm



85-2010

Razor Edge Serrated Iris Scissors

Gold Screw, One Cutting Edge with Micro Serrations

CODE	DESCRIPTION	LENGTH
202.20.10	Straight	4⅞ in 10.5 cm
202.21.10	Curved	4⅞ in 10.5 cm



202.20.10

Razor Edge Serrated Stevens Tenotomy Scissors

Gold Screw, One Cutting Edge with Micro Serrations

CODE	DESCRIPTION	LENGTH
202.50.12	Straight	5⅞ in 13 cm
202.50.13	Curved	5⅞ in 13 cm



202.50.13

Scissors

Razor Edge Serrated Stevens Tenotomy Scissors

Gold Screw, One Cutting Edge with Micro Serrations

CODE	DESCRIPTION	LENGTH
204.67.13	Curved	5½ in 13 cm

Troutman-Castroviejo Corneoscleral Scissors

Micro Pattern, 6.0 mm Equal Length Blades

CODE	DESCRIPTION	LENGTH
60-1792	Curved Right	4½ in 10.5 cm
60-1793	Curved Left	4½ in 10.5 cm



60-1792

Troutman-Katzin Corneal Scissors

With Lock, Medium Blades, Blunt Tips

CODE	DESCRIPTION	LENGTH
60-1762	Curved Left	4½ in 10.5 cm



Troutman-Katzin Corneal Scissors

Without Lock, Small Blades, Blunt Tips

CODE	DESCRIPTION	LENGTH
60-1763	Curved Right	4½ in 10.5 cm
60-1764	Curved Left	4½ in 10.5 cm



60-1763

Scissors

Utility Scissors

Large Ribbon Ring Handles with Flat Shanks, Blunt

CODE	DESCRIPTION	LENGTH
60-1853	Lightly Curved	4 in 10 cm

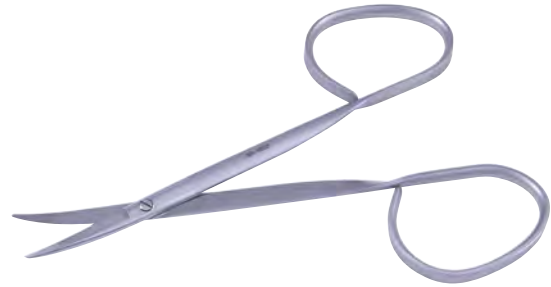

Vannas Capsulotomy Scissors

Very Delicate 6.0 mm Blades

CODE	DESCRIPTION	LENGTH
60-1833	Curved, Wide Handle	4 ½ in 11.5 cm



Vannas Capsulotomy Scissors

Very Delicate 6.0 mm Blades

CODE	DESCRIPTION	LENGTH
60-1834	Straight Blades	3 ¾ in 8.5 cm
60-1835	Curved Blades	3 ¾ in 8.5 cm
60-1836	Up-Angled Blades	3 ¾ in 8.5 cm
60-1839	Side-Angled Blades	3 ¾ in 8.5 cm



60-1835

Westcott Conjunctival Scissors

Wide Handle, Blunt Tips

CODE	DESCRIPTION	LENGTH
60-1859	Slightly Curved	5 in 12.5 cm



Scissors

Westcott Stitch Scissors

Curved, Sharp Tips

CODE	DESCRIPTION	LENGTH
60-1808	21 mm from Screw to Tip	4 ½ in 11.5 cm



Westcott Tenotomy Scissors

Curved Blunt Tips

CODE	DESCRIPTION	LENGTH
60-1796	Left-Handed	4 ½ in 11.5 cm
60-1797	Right-Handed	4 ½ in 11.5 cm
60-1799	Wide Handle, Right-Handed	5 ½ in 14 cm
60-1800	Micro Pattern, Curved Right	5 ½ in 14 cm



60-1796

Westcott Utility Scissors

CODE	DESCRIPTION	LENGTH
60-1842	Curved, Round Tips	5 in 12.5 cm



Wilmer Angled Scissors

CODE	DESCRIPTION	LENGTH
60-1850	Angled on Flat	4 in 10 cm



Shields

Fox Eye Shield

CODE	DESCRIPTION
60-3006	Aluminum

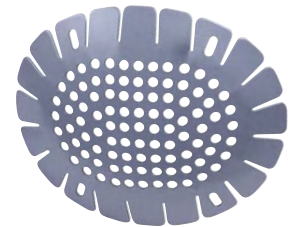

Spatulas

Barraquer Cyclodialysis Spatula

CODE	TIP	LENGTH
60-1068	0.5 mm	4 ³ / ₄ in 12 cm



Barraquer Iris Spatula

Hexagonal Handle

CODE	TIP	LENGTH
60-1067	0.25 mm	3 ¹ / ₂ in 9 cm



Castroviejo Cyclodialysis Spatula

Double-Ended

CODE	SIZE	LENGTH
60-1074	0.5 x 15 x 0.5 mm	5 ¹ / ₄ in 13.5 cm
60-1076	0.25 x 15 x 0.25 mm	5 ¹ / ₄ in 13.5 cm
60-1077	1.0 x 16 x 0.75 mm	5 ¹ / ₄ in 13.5 cm



Castroviejo Synechia Spatula

CODE	DESCRIPTION	LENGTH
60-1066	Double-Ended	5 ¹ / ₂ in 14 cm



Spatulas

Culler Iris Spatula

CODE	DESCRIPTION	LENGTH
60-1090	2.0 x 33 mm	5 in 12.5 cm
60-1091	1.0 x 28 mm	5 in 12.5 cm



Hirschman Lens Spatula

CODE	DESCRIPTION
60-1097	Lens Spatula



Iris Spatula

CODE	DESCRIPTION	LENGTH
60-1092	Malleable	5 in 12.5 cm



Jaffe Lens Spatula

Flat, Smooth

CODE	DESCRIPTION	LENGTH
60-1109	5 mm Wide	4 3/4 in 12 cm

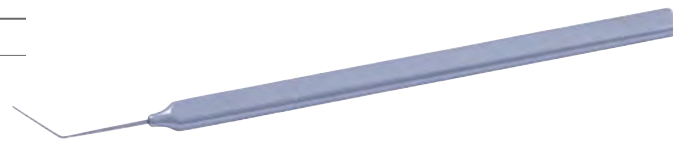

Johnson Spatula

CODE	DESCRIPTION
60-1095	Spatula



Wheeler Cyclodialysis Spatula

CODE	DESCRIPTION
60-1099	Double-Ended



Speculums

Alfonso Eye Speculum, Newborn

CODE	BLADE WIDTH	SPREAD
60-1974	5 mm	1 in 2.5 cm



Barraquer Eye Speculum

CODE	DESCRIPTION	BLADE WIDTH
60-1963	Adult	14 mm
60-1964	Heavy Wire, Adult	14 mm
60-1966	Solid Blades, Adult	14 mm
60-1962	Fenestrated, Pediatric	5.0 mm
60-1967	Fenestrated, Child	10 mm
60-1969	Solid Blades, Child	11 mm

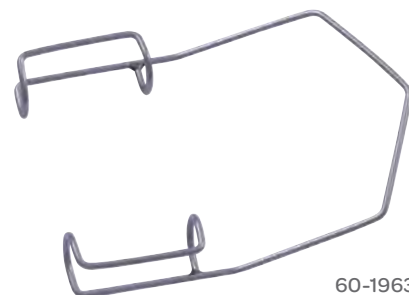

60-1963

Castroviejo Speculum

Medium Curved Arms

CODE	WIDTH	SPREAD
60-1948	17 mm	40 mm

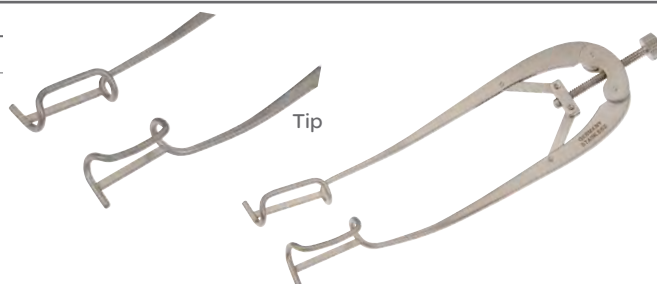

Tip

Speculums

Cook Eye Speculum

CODE	SIZE	BLADE WIDTH	LENGTH
60-1958	Child	11 mm	1 $\frac{3}{4}$ in 4.5 cm
60-1959	Adult	15 mm	1 $\frac{3}{4}$ in 4.5 cm



60-1958

Guyton-Park Speculum

Horizontal Suture Posts, Fenestrated Blades

CODE	BLADE WIDTH	LENGTH
60-1937	14 mm	3 $\frac{3}{8}$ in 7.5 cm



Kratz-Barraquer Speculum

CODE	DESCRIPTION
60-1960	Child

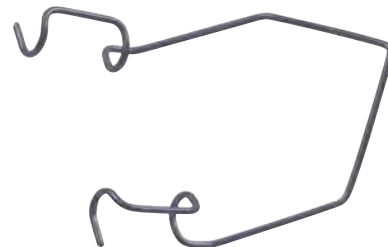

Lancaster Eye Speculum

CODE	BLADE WIDTH	SPREAD	LENGTH
60-1951	15 mm	35 mm	3 $\frac{1}{4}$ in 8.3 cm



Speculums

Lester-Burch Speculum

CODE	DESCRIPTION	LENGTH
60-1953	21 mm Wide Blades, Spread 32 mm	3¼ in 8.3 cm



Lieberman Speculum

17 mm Blades

CODE	DESCRIPTION
60-2003	K-Wire, Open Blades
60-2004	V-Wire, Open Blades
60-2005	Closed Blades

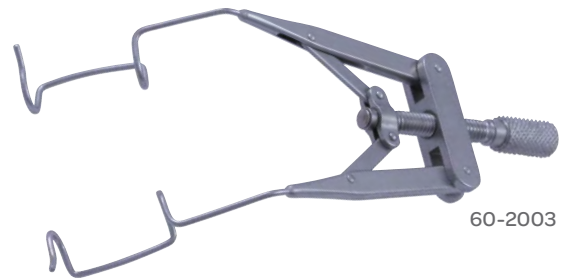

Knapp Eye Speculum

CODE	BLADE WIDTH	SPREAD	LENGTH
60-1954	14 mm	60 mm	3⅜ in 8.5 cm



Kratz-Barraquer Speculum

CODE	DESCRIPTION	LENGTH
60-1968	Open Blades, 14 mm Wide	
60-1970	15 mm Wide with Wings	1½ in 3.8 cm

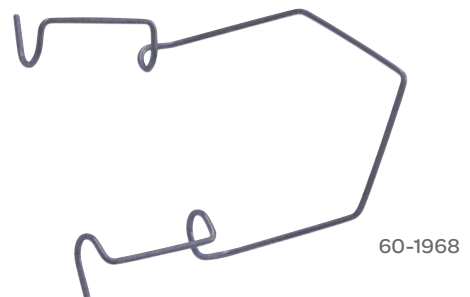

Speculums

Maumenee-Park Speculum

Fenestrated Blades

CODE	BLADE SPREAD	BLADE WIDTH	LENGTH
60-1941	43 mm	14 mm	3¼ in 8.3 cm



Pierce Eye Speculum

CODE	BLADE WIDTH	SPREAD
60-1961	11 mm	20 mm



Sauer Speculum

CODE	BLADE WIDTH	SPREAD
60-1971	4.0 mm	14 mm
60-1972	8.0 mm	25 mm



60-1971

Temporal Wire Speculum

Closed Wire

CODE	BLADE WIDTH	SPREAD	LENGTH
60-1412	14 mm	43 mm	

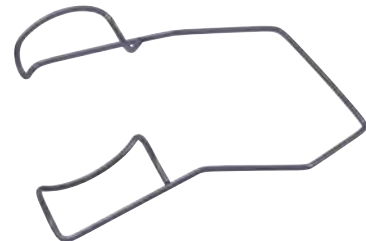

Spoons

Bunge Evisceration Spoon

CODE	DESCRIPTION	LENGTH
60-1295	Large	5½ in 14 cm



Spuds

Ellis Foreign Body Spud

CODE	DESCRIPTION	LENGTH
60-1443	Curved 1.0 mm Wide Blade	4 ¾ in 12 cm



Francis Spud

CODE	DESCRIPTION	LENGTH
60-1439	Flag-Shaped, Sharp	4 ¾ in 12 cm



Foreign Body Spud

CODE	DESCRIPTION	LENGTH
60-1441	Arrow-Shaped Head with Guard	4 ¾ in 12 cm



Golf Club Foreign Body Spud

CODE	DESCRIPTION
60-1438	Small, Sharp



Tonometers



Tonometer

CODE	DESCRIPTION	CODE	DESCRIPTION
60-6030	Schiötz Tonometer, Complete in Fitted Case	60-6031	Allen-Schiötz Tonometer



Scan the code above to learn more about our Orthopedics and Arthroscopy portfolio.

Orthopedics & Arthroscopy Portfolio



symmetry surgical™

Orthopedics & Arthroscopy



Calipers	O/A-2	Gouges	O/A-42	Reamers	O/A-77
Casts Tools	O/A-2	Graspers	O/A-46	Retractors	O/A-78
Cement Impaction	O/A-2	Handles	O/A-46	Rongeurs	O/A-94
Chisels	O/A-3	Hooks	O/A-47	Scissors	O/A-106
Clamps	O/A-7	Impactors	O/A-49	Shuttles	O/A-107
Containers	O/A-9	Kits	O/A-50	Skids	O/A-107
Curettes	O/A-13	Knives	O/A-57	Splitters	O/A-108
Cutters	O/A-16	Mallets	O/A-57	Tamps	O/A-109
Dissectors	O/A-16	Manipulators	O/A-62	Taps	O/A-110
Drivers	O/A-17	Osteotomes	O/A-62	Wire & Traction	O/A-110
Elevators	O/A-19	Picks	O/A-70		
Endoscopes	O/A-29	Plaster Tools	O/A-70		
Extractors	O/A-29	Probes	O/A-71		
Files	O/A-31	Punches	O/A-71		
Forceps	O/A-33	Rasps	O/A-76		

Questions? Contact us at customerservice@symmetrysurgical.com or learn more at symmetrysurgical.com



The Surgical Instrument Desk Reference

How to Use Our Catalog

The Symmetry Surgical catalog is designed with you in mind, to be your trusted resource for surgical instrumentation. We took great care in creating an easy-to-use, robust catalog and we think you'll be pleased with the design as you become more familiar with our broad portfolio.

Layout

The catalog is organized by surgical specialty *and* product function.

And we know that it is difficult to pick up an instrument and know what specialty it's listed in. To make your job easier, we've sorted the instruments in our portfolio by surgical function, too, including Energy, Laparoscopic, Retractors and Sterilization Solutions.

U.S. Customer Service

Your Symmetry Surgical Customer Service team wants to make ordering surgical instruments the easiest part of your day. We accept orders via phone, fax, email, our website, Global Healthcare Exchange (GHX) and through the mail.

PHONE

800.251.3000

(Available Monday through Friday, 8:30 AM–6:30 PM EST)

FAX

800.342.3272

EMAIL

customerservice@symmetrysurgical.com

ONLINE

symmetrysurgical.com

MAILING ADDRESS

Symmetry Surgical
Attn: Customer Service
3034 Owen Drive
Antioch, TN 37013

The Surgical Instrument Desk Reference

International Customer Service

PHONE

Symmetry Surgical Switzerland GmbH
+41 (0) 52 557 59 00
(Available Monday through Friday, 7:00-16:00 GMT)

Symmetry Surgical, Inc., USA
615.964.5672
(Available Monday through Friday, 8:30 AM–6:30 PM EST)

FAX

Symmetry Surgical Switzerland GmbH
+41 (0) 52 557 59 99

EMAIL

customerservice@symmetrysurgical.com
internationalorders@symmetrysurgical.com

ONLINE

symmetrysurgical.com

MAILING ADDRESS

Symmetry Surgical Switzerland GmbH
Bühlstrasse 27
CH-8200 Schaffhausen
Switzerland

Symmetry Surgical, Inc.
3034 Owen Drive
Antioch, TN 37013

INTERNATIONAL PAYMENT TERMS/RETURN GOODS POLICY/INSTRUMENT REPAIR & RESTORE PROGRAM/LITERATURE REQUESTS

Please contact your local distributor. Locate a local distributor contact, International Customer Service at +41 (0) 52 557 59 00 or 615.964.5672 (US).

Cardiovascular/Thoracic

Energy

Ear, Nose & Throat

General

Laparoscopic

Neurology

Obesity

OB/GYN

Ophthalmology

Orthopedics & Arthroscopy

Pediatrics

Rectal

Retractors

Spine

Urology

Sterilization Solutions

Alphabetical & Numeric Indexes

Calipers (Patella)

Patella Calipers

CODE	DESCRIPTION
14-016-000	Calibrations range from 0 to 30 mm



Cast Tools (Breaker)

Wolfe-Boehler Cast Breaker

CODE	LENGTH
11-2095	10 in 254 mm



Cast Tools (Plaster)

Beeson Plaster Spreader & Hennig Plaster Spreader

CODE	DESCRIPTION	LENGTH
40-7130	Serrated	11 ³ / ₄ in 298 mm
40-7027	Serrated	11 in 279 mm



Cement Impaction (Tibial)

Cement Well

CODE	DESCRIPTION
10-152-000	Small
10-153-000	Medium
10-154-000	Large



10-152-000

Cement Impaction (Tibial)

Compression Base

CODE	DESCRIPTION
10-149-000	Small
10-150-000	Medium
10-151-000	Large



Tibial Perforator

CODE	DESCRIPTION
10-155-000	Small
10-156-000	Medium
10-157-000	Large



10-155-000

Chisels (Acetubular)

Acetabular Chisel

CODE	DESCRIPTION
10-010-000	Curved

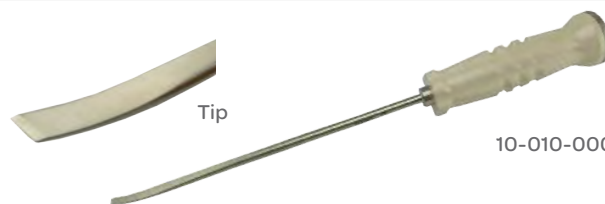

10-010-000

Chisels (Bone)

Alexander Chisel

CODE	DESCRIPTION	TIP	LENGTH
28-2606	Straight	¼in 6mm	7in 178mm



Chisels (Bone)

Bishop Chisel

CODE	DESCRIPTION	TIP WIDTH	LENGTH
27-6004	Straight	$\frac{1}{8}$ in 4 mm	6 in 150 mm



Bishop Chisel

CODE	DESCRIPTION
29-0401	#3, Stout



Chisel

Straight Stiletto

CODE	DESCRIPTION	TIP	LENGTH
67-7018		$\frac{3}{4}$ in 19 mm	9 $\frac{1}{2}$ in 241 mm



Chisel

CODE	DESCRIPTION	TIP	LENGTH
18-1011	Straight	$\frac{15}{64}$ in 6 mm	9 $\frac{1}{2}$ in 241 mm



Chisels (Bone)

Chisel

CODE	DESCRIPTION	TIP	LENGTH
10-015-000	Offset		
10-003-000		1/3 in 8 mm	17 in 432 mm



10-015-000

Hibbs Chisel

CODE	DESCRIPTION	TIP	LENGTH
28-5006	Straight	1/4 in 6 mm	9 1/2 in 241 mm
28-5010	Straight	3/8 in 10 mm	9 1/2 in 241 mm
28-5012	Straight	1/2 in 13 mm	9 1/2 in 241 mm
28-5016	Straight	5/8 in 16 mm	9 1/2 in 241 mm
28-5020	Straight	3/4 in 19 mm	9 1/2 in 241 mm
28-5025	Straight	1 in 25 mm	9 1/2 in 241 mm
28-5056	Curved	1/4 in 6 mm	9 1/2 in 241 mm
28-5062	Curved	1/2 in 13 mm	9 1/2 in 241 mm
28-5070	Curved	3/4 in 19 mm	9 1/2 in 241 mm
28-5075	Curved	1 in 25 mm	9 1/2 in 241 mm
28-5032	Curved	1 1/4 in 32 mm	9 1/2 in 241 mm

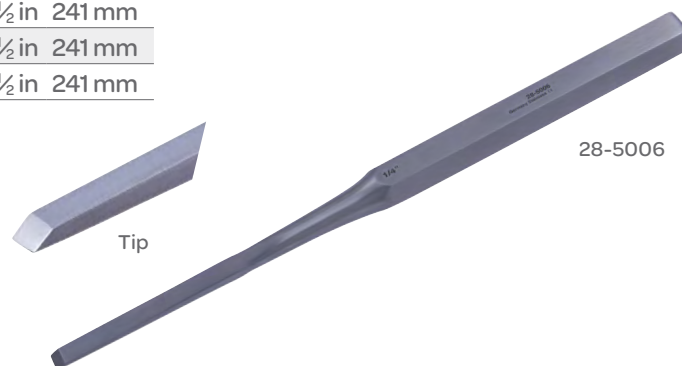

28-5006

Lexer Chisel

CODE	DESCRIPTION	TIP	LENGTH
28-5407	Straight, Phenolic	1/4 in 6 mm	7 in 178 mm
28-5410	Straight, Phenolic	3/8 in 8 mm	7 in 178 mm
28-5412	Straight, Phenolic	3/8 in 10 mm	7 in 178 mm
28-5433	Straight, Phenolic	3/8 in 10 mm	8 5/8 in 219 mm
28-5435	Straight, Phenolic	3/4 in 15 mm	8 5/8 in 219 mm
28-5439	Straight, Phenolic	1 in 30 mm	8 5/8 in 219 mm



28-5407

Chisels (Bone)

Stiletto Chisel

CODE	DESCRIPTION	TIP	LENGTH
46-3071	Straight	¼ in 6 mm	8½ in 216 mm
46-3072	Straight	⅜ in 10 mm	8½ in 216 mm
46-3073	Straight	½ in 13 mm	8½ in 216 mm
46-3074	Straight	⅝ in 16 mm	8½ in 216 mm
46-3075	Straight	¾ in 19 mm	8½ in 216 mm
46-3083	Curved	½ in 13 mm	8½ in 216 mm
46-3085	Curved	¾ in 19 mm	8½ in 216 mm



46-3075

Stille Chisel

CODE	DESCRIPTION	TIP	LENGTH
28-4320	Straight	¾ in 19 mm	8 in 203 mm
28-4325	Straight	1 in 25 mm	8 in 203 mm

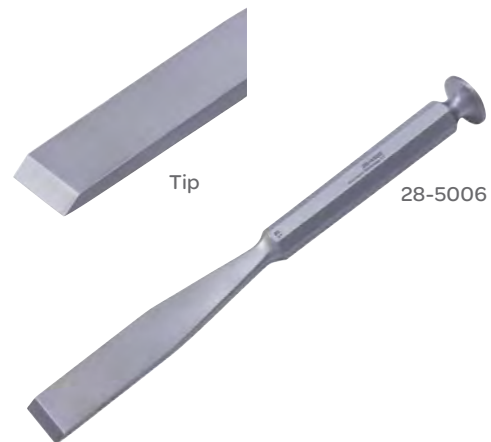

28-5006

Thin Chisel Blade

Flexible Chisel Blade

CODE	TIP
11-025-000	2½ x 8 mm
11-026-000	2½ x 10 mm
11-027-000	2½ x 12 mm
11-028-000	2½ x 20 mm



11-025-000

Chisels (Bone)

U.S. Army Chisel

CODE	DESCRIPTION	TIP	LENGTH
28-2006	Straight	6 mm	6 ¼ in 159 mm
28-2012	Straight	12 mm	6 ¼ in 159 mm
28-2018	Straight	18 mm	6 ¼ in 159 mm

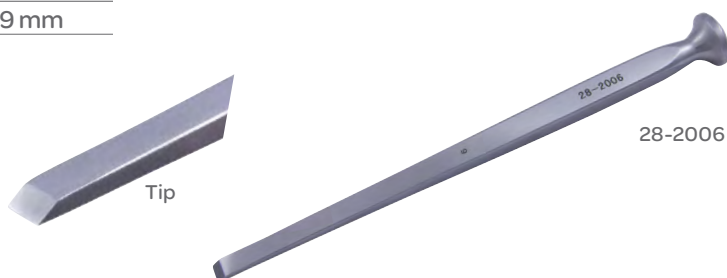

Clamps (Bone Holding)

Lowman Bone Holding Clamp

CODE	DESCRIPTION	LENGTH
35-8018	1x2 Prongs	7 ¼ in 185 mm
35-8020	1x2 Prongs	8 in 200 mm



Lowman Bone Holding Clamp

CODE	DESCRIPTION	LENGTH
35-8215	1x1 Prongs	4 ¾ in 120 mm
35-8025	1x1 Prongs	7 ¼ in 185 mm
35-8026	1x1 Prongs	8 in 200 mm

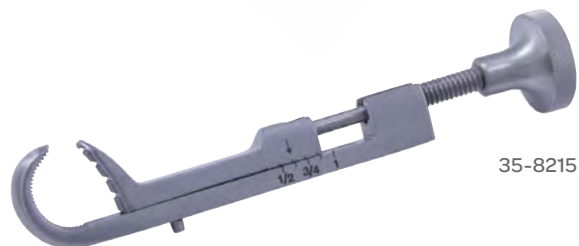

Clamps (Cartilage)

Martin Cartilage Clamp

CODE	LENGTH
35-2116	6¼ in 160 mm
35-2119	7¼ in 185 mm
35-2120	8 in 200 mm



Walton Cartilage Clamp

CODE	DESCRIPTION	LENGTH
35-2150	Slight Curve	8 in 200 mm



Clamps (Internal Fixation)

Internal Fixation Clamp

CODE	DESCRIPTION	LENGTH
35-1130	With Pin Holder	6 in 150 mm



Clamps (Meniscus)

Meniscus Clamp

CODE	DESCRIPTION	LENGTH
37-4007	1x2 Teeth	7 1/8 in 181 mm



Containers

For a comprehensive listing of our sterilization portfolio, visit the Sterilization Solutions section of our catalog.

Containers (Arthroscope)

Combination Arthroscope Case

CODE	DESCRIPTION	DIMENSIONS
3-7110	Combination Arthroscope Case	10 1/2 x 6 1/4 x 1 9/25 in 257 x 159 x 34 mm



Containers (Arthroscope & Cable)

Arthroscopy Scope & Cable Case

CODE	DESCRIPTION	DIMENSIONS
3-5120	Arthroscopy Scope and Cable Case	16 9/10 x 6 1/10 x 1 1/2 in 430 x 155.5 x 39.5 mm



Containers (Delivery)

Delivery Case

CODE	DESCRIPTION	LENGTH
25-006-000	For Use with Hip Revision System	6 in 150 mm



Containers (Drill)

Drill Tray

For Use with Ultra™ Container

CODE	DESCRIPTION	DIMENSIONS
B1212-DRILL	Aluminum	12x12x8 in 304x304x203 mm



Containers (Gouge & Osteotome)

Gouge & Osteotome Case

CODE	DIMENSIONS
21-2500	9 x 6 $\frac{7}{8}$ x 2 $\frac{1}{4}$ in 229 x 175 x 57 mm



Containers (Modular)

Modular Hand Held Instrument Case

CODE	DESCRIPTION	DIMENSIONS (INTERNAL)	
5-1150	Modular Hand Held Instrument Case	18 ¼ x 7 ½ x 2 ¾ in	464 x 190 x 70 mm



Containers (MultiPak)

MultiPak 20 in (508 mm) Endoscopic Kit*

CODE	DESCRIPTION	QTY
5500	20 in Endoscopic Kit Includes:	
5000-01-475P	Base	1/Kit
5000-50-175P	Lid	1/Kit
5111	Wire Rack	1/Kit
5022	Insert Tray	1/Kit
5200	Bar Holders	4/Kit
5233	"T" Brackets, and Hardware Insert Tray	4/Kit

*Instruments and silicone parts are not included

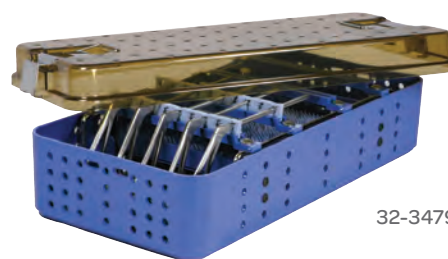

32-3479

Containers (Rongeur Rack)

Rongeur Rack

CODE	DESCRIPTION
B2175-RONGEUR	For Endoscopic Container C22856

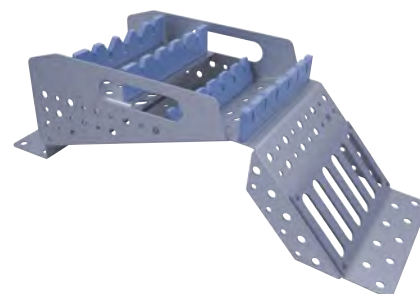

Containers (Sterilization Case)

Sterilization Case

CODE	DESCRIPTION	DIMENSIONS	LENGTH
46-3086	Case For Curved Stiletto Chisels		
46-3056	Case For Curved Stiletto Osteotomes		8 ½ in 216 mm
46-3060	Case For Straight Stiletto Osteotomes, Kit		8 ½ in 216 mm
25-035-000	For Acetabular Prep 30-033-000		
25-022-000	For Complete Extractor Tray 30-035-000		
25-034-000	For Complete MIK Retractor System 30-032-000		
25-024-000	For Flexible Osteotome System-Set 30-005-000		
25-028-000	For Hip Retractor (Hybrid) Set 30-034-000		
25-015-000	For Screw Removal System 30-009-000		
21-1020	Sterilizing & Carrying Case Holds 8 Gouges or Osteotomes	8 7/8 x 1 ¼ in	225 x 32 mm
46-3066	Stiletto Straight Osteotome Case		8 ½ in 216 mm



Containers (Tray)

Shutt Tray

CODE	DESCRIPTION	DIMENSIONS
B-SHUTT	Aluminum, For Use with C18138	17 x 12 x 6 in 432 x 305 x 152 mm



Containers (Tray)

Universal Hand Held Case & Lid

CODE	LENGTH
5-1110	13½ x 8 ⅘ x 2½ in 343 x 224 x 64 mm



Container Accessories (Rack)

Arthroscopy Rack

CODE	DESCRIPTION
ARTH-RACK	For Use with B-Shutt, Holds 15 Instruments

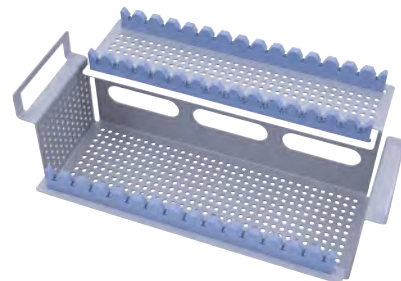

Curettes (Arthroscopic)

Curette

In-line Handle, Round

CODE	DESCRIPTION	WORKING DIAMETER	WORKING LENGTH
1010801	Open 4 mm	4.9 mm	4 9/16 in 116 mm
1010802	Open 7 mm	6.9 mm	4 9/16 in 116 mm



Curettes (Bone)

Bone Curette

CODE	DESCRIPTION	CUP	LENGTH	
29-7076	Straight	3.6 mm	10 in	250 mm
29-7077	Straight	4.4 mm	10 in	250 mm
29-7078	Straight	5.2 mm	10 in	250 mm
29-7079	Straight	6 mm	11 in	279 mm
29-7071	Angled	4.4 mm	10 in	250 mm
29-7072	Angled	5.2 mm	10 in	250 mm
29-7073	Angled	6 mm	10 in	250 mm



Bone Curette

CODE	DESCRIPTION	LENGTH
29-4906	Oval Cup, 6 mm	7 in 178 mm



Bruns Curette

Reverse Angle, Hollow Handle

CODE	CUP SIZE	LENGTH
32-3490	#0000 3 mm	9 in 229 mm
32-3491	#000 3.2 mm	9 in 229 mm
32-3492	#00 3.4 mm	9 in 229 mm
32-3493	#0 3.7 mm	9 in 229 mm
32-3494	#1 4.7 mm	9 in 229 mm
32-3495	#2 5.7 mm	9 in 229 mm
32-3496	#3 7 mm	9 in 229 mm
32-3497	#4 8.4 mm	9 in 229 mm
32-3498	#5 8.9 mm	9 in 229 mm
32-3499	#6 10.2 mm	9 in 229 mm



Bruns Curette

Straight, Hexagonal Handle

CODE	CUP SIZE	LENGTH
32-3400	#000 3.2 mm	9 in 229 mm
32-3401	#00 3.4 mm	9 in 229 mm
32-3402	#0 3.7 mm	9 in 229 mm
32-3403	#1 4.7 mm	9 in 229 mm
32-3404	#2 5.7 mm	9 in 229 mm
32-3405	#3 7 mm	9 in 229 mm
32-3407	#4 8.4 mm	9 in 229 mm
32-3406	#5 8.9 mm	9 in 229 mm
32-3408	#6 10.2 mm	9 in 229 mm



Curettes (Bone)

Bruns Curette

Straight, Hollow Handle

CODE	CUP SIZE	LENGTH
32-3470	#0000 3 mm	9 in 229 mm
32-3471	#000 3.2 mm	9 in 229 mm
32-3472	#00 3.4 mm	9 in 229 mm
32-3473	#0 3.7 mm	9 in 229 mm
32-3474	#1 4.7 mm	9 in 229 mm
32-3475	#2 5.7 mm	9 in 229 mm
32-3476	#3 7 mm	9 in 229 mm
32-3477	#4 8.4 mm	9 in 229 mm
32-3478	#5 8.9 mm	9 in 229 mm
32-3479	#6 10.2 mm	9 in 229 mm



Bruns Curette

Forward Angle, Hollow Handle

CODE	CUP SIZE	LENGTH
32-3480	#0000 3 mm	9 in 229 mm
32-3481	#000 3.3 mm	9 in 229 mm
32-3482	#00 3.9 mm	9 in 229 mm
32-3483	#0 4.5 mm	9 in 229 mm
32-3484	#1 5.3 mm	9 in 229 mm
32-3485	#2 6 mm	9 in 229 mm
32-3486	#3 7.3 mm	9 in 229 mm
32-3487	#4 8.2 mm	9 in 229 mm
32-3488	#5 9.8 mm	9 in 229 mm
32-3489	#6 12.5 mm	9 in 229 mm



Cobb Curette

CODE	SIZE	TIP	LENGTH
23-2570	#000	3.25 mm	11 in 279 mm
23-2571	#00	4 mm	11 in 279 mm
23-2572	#0	5 mm	11 in 279 mm
23-2573	#1	6 mm	11 in 279 mm
23-2574	#2	7.5 mm	11 in 279 mm
23-2575	#3	9 mm	11 in 279 mm
23-2576	#4	11.5 mm	11 in 279 mm
23-2577	#5	13 mm	11 in 279 mm
23-2578	#6	15.5 mm	11 in 279 mm

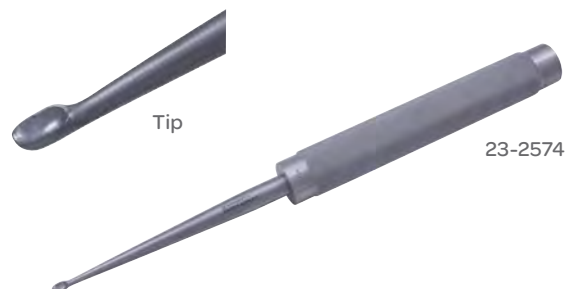

Curettes (Bone)

Hip Revision Reverse Curette

CODE	TIP	LENGTH
10-054-000	6 mm	17 in 432 mm
10-006-000	7 mm	17 in 432 mm
10-007-000	9 mm	17 in 432 mm
10-055-000	11 mm	17 in 432 mm



Cutters (Arthroscopic)

Suture Cutter

CODE
1000647
1000688
1021101



Dissectors

Periosteal Elevator

CODE	DESCRIPTION	BLADE WIDTH	LENGTH
65-1121	Sharp	$\frac{3}{16}$ in 5 mm	8 in 203 mm



Drivers (Calcar)

Calcar Driver

CODE	DESCRIPTION	LENGTH
11-074-000	Tri-Shank End	1½ in 38 mm

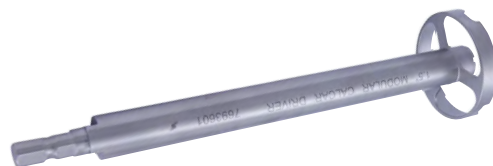

Drivers (Flexible)

Flexible Hex Driver

CODE	DESCRIPTION	LENGTH
09-147-000	¼ in Square Drive	4 mm



Drivers (Hand-Operated)

Hudson T-Handle

CODE	DESCRIPTION
10-022-000	Driver



Drivers (Hex)

Hex Driver

CODE	DESCRIPTION
10-114-000	2.5 mm
10-115-000	3.5 mm
10-117-000	1.5 mm

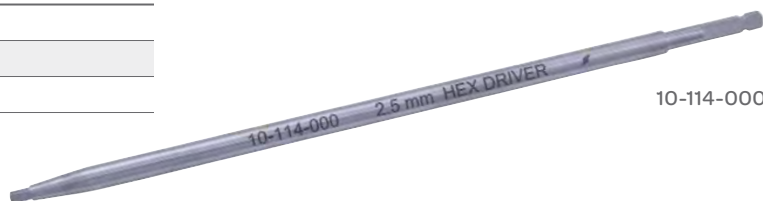

10-114-000

Drivers (Hex)

Universal Hex Driver

CODE	DESCRIPTION	LENGTH
09-142-000	¼ in Square Drive	3.5 mm
09-143-000	¼ in Square Drive	4 mm



09-143-000

Drivers (Universal Handle)

Universal Driver Handle

CODE
10-113-000



42.5° Driver

Bayonet

CODE	DESCRIPTION
09-078-000	½ in, Hudson Connection



Screwdriver

CODE	DESCRIPTION
10-120-000	(A/O), Straight
10-141-000	Cruciform (A/O), Mini
10-119-000	Cruciform (A/O), Small



10-120-000

Elevators



Molt Periosteal Elevator

CODE	DESCRIPTION	LENGTH	
26-3700	#9	7¼ in	185 mm
32-3420	#9	7¼ in	185 mm



Oldberg Dissector

CODE	LENGTH
26-4809	7 in 175 mm

Elevators (Metatarsal)



Chandler Elevator

26-5621

CODE	DESCRIPTION	BLADE WIDTH		LENGTH	
26-5621	Blunt	½ in	13 mm	7½ in	190 mm
26-5622	Blunt	¾ in	19 mm	8 in	200 mm
26-5623	Blunt	1 in	25 mm	9 in	230 mm
26-5624	Blunt	1⅜ in	30 mm	10 in	250 mm
26-5625	Slight Curve	1 in	25 mm	7½ in	190 mm

Elevators (Metatarsal)



Cloward Periosteal Elevator

CODE	DESCRIPTION	BLADE WIDTH	LENGTH
26-2777	#4	½ in 13 mm	7¾ in 195 mm



26-5500

Crego Elevator

CODE	DESCRIPTION	BLADE WIDTH	LENGTH
26-5500	Blunt, Full Curve	⅝ in 16 mm	7½ in 190 mm
26-5503	Blunt, Slight	⅝ in 16 mm	8 in 200 mm



78-5011

McGlamary Metatarsal Elevator

CODE	DESCRIPTION	BLADE WIDTH	LENGTH
78-5009	Sharp	⅜ in 10 mm	6¼ in 160 mm
78-5011	Sharp	⅞ in 11 mm	6¼ in 160 mm
78-5013	Sharp	½ in 13 mm	6¼ in 160 mm
78-5015	Sharp	⅝ in 16 mm	6¼ in 160 mm
78-5017	Sharp	⅞ in 17 mm	6¼ in 160 mm

Elevators (Osteophyte)



57-5038

Osteophyte Periosteal Elevator

CODE	DESCRIPTION	LENGTH	
57-5038	90° Tip	8 in	200 mm
57-5039	Curved, Rounded Tip, Sharp	7¼ in	185 mm
65-1064	Curved, Rounded Tip, sharp	8 in	200 mm

Elevators (Periosteal)



26-4802

Adson Periosteal Elevator

CODE	DESCRIPTION	BLADE WIDTH		LENGTH	
26-4801	#1, Flat, Straight, Chisel Style	5/16 in	8 mm	6½ in	165 mm
26-4802	#2, Blunt, Light Curve	¼ in	6 mm	6½ in	165 mm
26-4803	#3, Sharp, Straight, Strong Curve	¼ in	6 mm	6½ in	165 mm
26-4804	#4, Sharp, Straight	¼ in	6 mm	6½ in	165 mm



Tip



65-1030

Adson Periosteal Elevator

CODE	DESCRIPTION	BLADE WIDTH		LENGTH	
65-1030	#1, Chisel Edge	5/16 in	8 mm	6½ in	165 mm
65-1031	#2, Curved, Blunt Edge	¼ in	6 mm	6½ in	165 mm
65-1032	#3, Curved, Semi-Sharp Edge	¼ in	6 mm	6½ in	165 mm
65-1033	#4, Straight, Semi-Sharp Edge	5/16 in	8 mm	6½ in	165 mm

Elevators (Periosteal)



Carroll Periosteal Elevator

CODE	DESCRIPTION	BLADE WIDTH	LENGTH
65-2549	Double-Ended	$\frac{1}{8}$ and $\frac{3}{8}$ in 3 and 10 mm	5 $\frac{1}{2}$ in 140 mm



26-5021

Cobb Elevator

CODE	BLADE WIDTH	LENGTH
26-5023	$\frac{1}{2}$ in 13 mm	14 in 355 mm
26-5020	$\frac{5}{8}$ in 16 mm	14 in 355 mm
26-5021	$\frac{3}{4}$ in 19 mm	14 in 355 mm
26-5022	1 in 25 mm	14 in 355 mm



Cottle Elevator

CODE	DESCRIPTION	LENGTH
26-2766	Double-Ended	8 $\frac{5}{8}$ in 219 mm

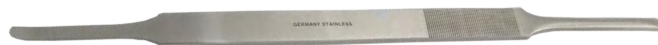

Cottle-McKenty Periosteal Elevator

CODE	DESCRIPTION	LENGTH
26-4226	Periosteal Elevator	8 $\frac{1}{2}$ in 215 mm

Elevators (Periosteal)



Tip



26-6201

Cushing Elevator

CODE	DESCRIPTION	LENGTH	
26-6201	15 mm Wide, Round Edge, Slightly Curved	7 1/8 in	180 mm
26-6202	15 mm Wide, Square Edge, Slightly Curved	7 1/8 in	180 mm



65-1047

Cushing "Little Joker" Periosteal Elevator

CODE	DESCRIPTION	BLADE WIDTH		LENGTH	
65-1047	Hollow Handle	1/4 in	6 mm	6 in	152 mm
26-6203	Solid Handle	1/4 in	6 mm	7 1/2 in	190 mm
65-1048	Solid Handle	1/4 in	6 mm	7 1/2 in	191 mm



65-1075

Cushing Periosteal Elevator

CODE	DESCRIPTION	BLADE WIDTH		LENGTH	
65-1075	Rounded Edge, Sharp, Wide	5/8 in	16 mm	7 1/4 in	185 mm
65-1076	Square Edge, Sharp, Wide	5/8 in	16 mm	7 1/4 in	185 mm



Cushing Periosteal Elevator

CODE	DESCRIPTION	BLADE WIDTH		LENGTH	
65-1050	Sharp, Narrow	1/4 in	6 mm	8 1/8 in	206 mm

Elevators (Periosteal)

Freer Elevator

Double-Ended, Sharp and Blunt Ends



55-7026

CODE	TIP	LENGTH	
55-7027	4.5 mm	7½ in	190 mm
55-7026	6.5 mm	7½ in	190 mm



65-1002

Hoehn Periosteal Elevator

CODE	DESCRIPTION	BLADE WIDTH		LENGTH	
65-1001	#1	5/16 in	8 mm	7 in	178 mm
65-1002	#2	5/8 in	16 mm	7¼ in	185 mm
65-1003	#1	¾ in	19 mm	7½ in	191 mm



Iowa University Periosteal Elevator

CODE	BLADE WIDTH	LENGTH	
65-1080	1¼ in 17 mm	7¼ in	185 mm



Joseph Periosteal Elevator

CODE	DESCRIPTION	BLADE WIDTH		LENGTH	
26-4404	Sharp, Light Curve	3/16 in	4 mm	6½ in	165 mm

Elevators (Periosteal)



Key Periosteal Elevator

65-2510

CODE	BLADE WIDTH	LENGTH
65-2510	¼ in 6 mm	7½ in 191 mm
65-2511	⅜ in 10 mm	7½ in 191 mm
65-2512	½ in 13 mm	7½ in 191 mm
65-2513	¾ in 19 mm	7½ in 191 mm
65-2514	1 in 25 mm	7½ in 191 mm



Key Periosteal Elevator

26-5606

CODE	DESCRIPTION	BLADE WIDTH	LENGTH
26-5604	Slight Curve	⅛ in 3 mm	7½ in 190 mm
26-5606	Slight Curve	¼ in 6 mm	7½ in 190 mm
26-5612	Slight Curve	½ in 13 mm	7½ in 190 mm
26-5620	Slight Curve	¾ in 19 mm	7½ in 190 mm
26-5625	Slight Curve	1 in 25 mm	8½ in 215 mm

Kleinert-Kutz Elevator & Dissector

CODE	DESCRIPTION	TIP	LENGTH
20-1788	Sharp, Double-Ended	2 mm and 3 mm	5 in 127 mm



26-1411

Lane Periosteal Elevator

CODE	DESCRIPTION	LENGTH
26-1411	6 mm Blunt	7¾ in 197 mm
26-1412	10 mm Blunt	7¾ in 197 mm

Elevators (Periosteal)



Langenbeck Periosteal Elevator

65-1116

CODE	DESCRIPTION	BLADE WIDTH		LENGTH	
65-1115	Narrow	¼ in	6 mm	8 ¼ in	210 mm
65-1116	Wide	1 ¼ in	27 mm	7 ½ in	191 mm



23-0279

Locke Elevator

CODE	DESCRIPTION	LENGTH	
23-0279	Narrow Blade	4 ½ in	115 mm
23-0290	Wide Blade	5 in	125 mm



Love-Adson Periosteal Elevator

CODE	DESCRIPTION	BLADE WIDTH		LENGTH	
65-1110	Semi-Sharp	¾ in	5 mm	6 ½ in	165 mm



26-4224

McKenty Periosteal Elevator

CODE	DESCRIPTION	TIP	LENGTH	
26-4224	Sharp, Light Curve	4 mm	6 in	150 mm
26-4225	Sharp, Light Curve	5 mm	6 in	150 mm

Elevators (Periosteal)



Periosteal Elevator

65-1056

Sharp

CODE	DESCRIPTION	TIP WIDTH	LENGTH
65-1056	#1	$\frac{3}{16}$ in 5 mm	8 in 203 mm
65-1057	#2	$\frac{1}{4}$ in 6 mm	8 in 203 mm
65-1058	#3	$\frac{5}{16}$ in 8 mm	8 in 203 mm
65-1059	#4	$\frac{15}{32}$ in 12 mm	8 in 203 mm



Tip



Periosteal Elevator

CODE	DESCRIPTION	TIP	LENGTH
26-6416	Double-Ended	6 mm	$7\frac{1}{4}$ in 185 mm



26-4452

Periosteal Elevator

Phenolic Handle, Sharp

CODE	DESCRIPTION	TIP	LENGTH
26-4450	Straight Edge	3 mm	$7\frac{1}{4}$ in 185 mm
26-4451	Straight Edge	4 mm	$7\frac{3}{4}$ in 197 mm
26-4452	Straight Edge	5 mm	$7\frac{1}{4}$ in 185 mm
26-4453	Round Edge	6 mm	$7\frac{1}{4}$ in 185 mm



Periosteal Elevator

26-4455

Phenolic Handle, Sharp

CODE	DESCRIPTION	LENGTH
26-4454	Straight Blade, 14 mm Oval Edge	$7\frac{3}{4}$ in 195 mm
26-4455	Curved Blade, 14 mm Oval Edge	$7\frac{3}{4}$ in 195 mm

Elevators (Periosteal)



Periosteal Elevator

Phenolic Handle, Sharp

CODE	DESCRIPTION	LENGTH
26-4457	Straight Blade, Straight Edge, 13 mm	7¼ in 185 mm
26-4458	Curved Blade, Round Edge 13 mm	7¾ in 197 mm



26-3751

Sayre Periosteal Elevator

Double-Ended, 5 mm and 9 mm

CODE	DESCRIPTION	LENGTH
26-3750	Sharp	6½ in 165 mm
26-3751	Blunt	6½ in 165 mm



Sedillot Periosteal Elevator

CODE	DESCRIPTION	BLADE WIDTH	LENGTH
26-4738	Periosteal Elevator, Sharp	¼ in 17 mm	7 in 177 mm

Endoscopes (Arthroscopic)

Arthrolux Scope

CODE	DESCRIPTION	WORKING LENGTH
455-18300-SSI	0°, 4 mm	175 mm
455-19300-SSI	30°, 4 mm	175 mm
455-20300-SSI	70°, 4 mm	175 mm
455-29200-SSI	30° 2, 7 mm	180 mm

Extractors (Acetabular Component)

Acetabular Component Gripper

CODE	DESCRIPTION
12-006-000	Gripper

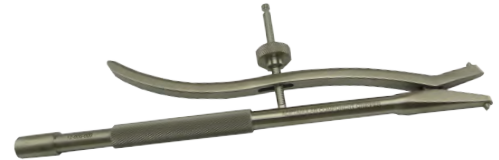

Extractors (Acetabular Prosthesis)

Acetabular Component Forceps

CODE	DESCRIPTION
14-001-000	Forceps



Extractors (Femoral Prosthesis)

Closed Looped Extractor

CODE	DESCRIPTION
12-029-000	



Femoral Extractor

CODE	DESCRIPTION
12-001-000	Slap Hammer



Extractors (Femoral Prosthesis)

Hip Stem Extractor

CODE	DESCRIPTION
12-031-000	Universal Modular



Hook Stem Extractor

CODE
12-030-000



Slap Hammer

CODE	DESCRIPTION
12-007-000	Small

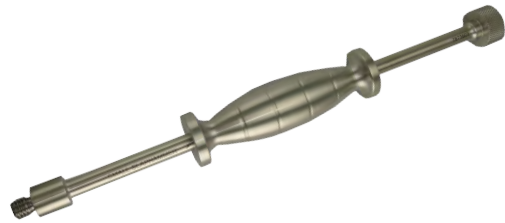

Stem Adapter

CODE	DESCRIPTION
12-004-000	One Piece



Extractors (Prosthesis)

Extraction Screw

CODE
12-010-000



Extractors (Prosthesis)

Screw Extractor

CODE	DESCRIPTION
10-116-000	2.5 mm
10-130-000	3.5 mm



10-116-000

Extractors (Tap)

Conical Tap

CODE	DESCRIPTION
12-008-000	9 mm
12-009-000	11 mm

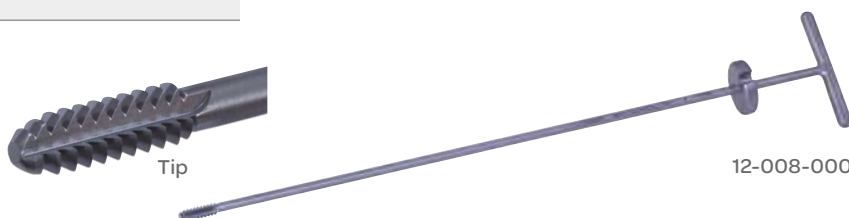

12-008-000

Files (Bone)

Bone File

Double-Ended

CODE	TIP	LENGTH
26-1350	5 mm and 7 mm	7¼ in 184 mm



Tip

Bone File

Single-Ended

CODE	TIP	LENGTH
26-1428	2-Sided, One Convex and One Flat	11 in 279 mm



Files (Bone)

Bone File

Single-Ended, Bayonet



CODE	TIP	LENGTH
26-1450	2-Sided, One Convex and One Flat	9½ in 241 mm

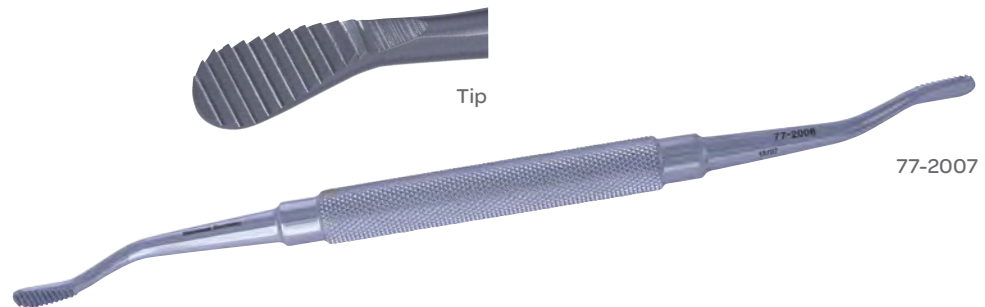

Miller Bone Files

CODE	TIP	LENGTH
77-2007	#10, Serrated, Double-Ended	5 mm Wide 7 in 178 mm
77-2008	#12, Double-Ended	5 and 7 mm 7 in 178 mm
77-2009	#12A, Serrated, Double-Ended	5 mm Wide 7 in 178 mm
77-2010	#12CA, Double-Ended with Cross Serrations	7 in 178 mm
77-2011	#33, Double-Ended with Plain Serrations	6 and 5 mm 7 in 178 mm
77-2002	#93, Angled with Serrations, Singled-Ended	2 mm Wide 9 in 229 mm

Forceps (Arthroscopic)

Grasper

CODE	DESCRIPTION	BITE WIDTH
1010304	Straight Tip, Alligator, Curved up 15°	3.5 mm
1010302	Straight Tip, Cup Curved up 15°	3.4 mm
1010305	Straight Tip, Alligator, Large	3.8 mm
1010303	Alligator, Straight	3.4 mm
1010301	Cupped Straight	3.4 mm
1040301	Loose Body	3.4 mm
1010306	Loose Body, Straight	3.4 mm



Forceps (Bone Cutting)

Bone Cutting Forceps

CODE	DESCRIPTION	LENGTH
33-0215	Straight	6 in 150 mm



Horsley Bone Cutting Forceps

Double-Action

CODE	DESCRIPTION	LENGTH
30-1298	Curved Shaft, Angular Jaw	10 ½ in 267 mm



Forceps (Bone Cutting)

Liston Bone Cutting Forceps

CODE	DESCRIPTION	LENGTH
30-1310	Straight	5½ in 140 mm
33-2017	Straight	6¾ in 170 mm
33-2019	Straight	7½ in 190 mm
33-2022	Straight	8¾ in 220 mm
33-5115	Curved	6 in 150 mm



30-1310

Liston Bone Cutting Forceps

CODE	DESCRIPTION	LENGTH
33-2119	Angled	7½ in 190 mm



Liston-Key Bone Cutting Forceps

CODE	DESCRIPTION	LENGTH
33-7527	S-Shaped	10¾ in 270 mm

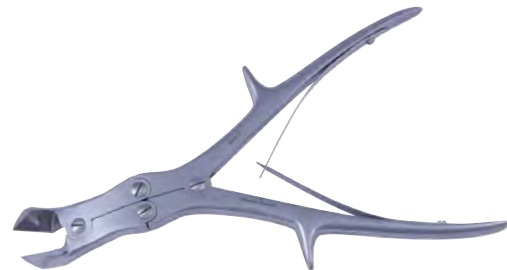

McIndoe Bone Cutting Forceps

CODE	DESCRIPTION	LENGTH
33-5917	Angled on Flat	7 in 175 mm



Forceps (Bone Cutting)

Ruskin Bone Cutting Forceps

CODE	DESCRIPTION	LENGTH
30-1290	Double-Action	7¼ in 185 mm



Ruskin-Rowland Bone Forceps

CODE	DESCRIPTION	LENGTH
33-5618	Straight	7¼ in 185 mm
33-5518	Angled	7⅛ in 180 mm
33-5718	Angled	7¼ in 185 mm

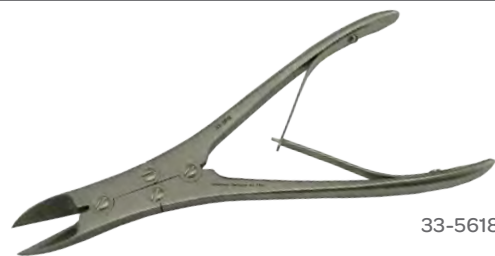

Stille-Liston Bone Forceps

CODE	DESCRIPTION	LENGTH
30-1295	Double-Action	10½ in 267 mm
30-1296	Double-Action	10½ in 267 mm

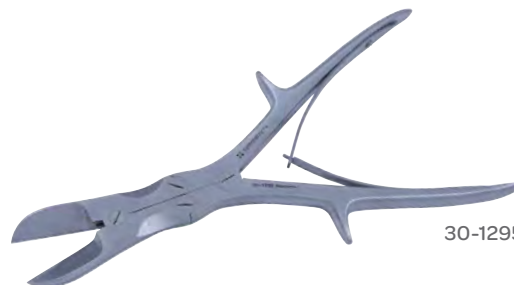

Forceps (Bone Holding)

Bishop Bone Forceps

CODE	DESCRIPTION	LENGTH
35-6472	With Adjustable Jaw	9 in 230 mm
35-6473	With Adjustable Jaw	13 in 355 mm



Forceps (Bone Holding)

Hey Groves Bone Holding Forceps

CODE	DESCRIPTION	LENGTH
35-7510	Speed Lock, with Teeth	11 $\frac{7}{8}$ in 300 mm



Kern Bone Holder Forceps

CODE	DESCRIPTION	LENGTH
35-3514	With Ratchet	5 $\frac{3}{4}$ in 145 mm
35-3523	With Ratchet	8 $\frac{1}{2}$ in 215 mm



Lewin Bone Forceps

CODE	DESCRIPTION	LENGTH
35-1118	Slightly Curved, Serrated	7 $\frac{1}{8}$ in 180 mm



Verbugge Bone Holding Forceps

CODE	DESCRIPTION	JAW	LENGTH
35-7517	With Short Ratchet	5 mm	7 in 175 mm
35-7525	With Long Ratchet	9.5 mm	10 in 250 mm



Forceps (Bone Holding)

Verbugge Bone Holding Forceps

CODE	LENGTH
35-7531	7½ in 190 mm



Forceps (Bone Reduction)

Bone Reduction Forceps

Curved

CODE	DESCRIPTION	LENGTH
35-1137	Pointed Tips	5 in 125 mm
35-1138	Pointed Tips, Serrated	5¼ in 135 mm



35-1137

Bone Reduction Forceps

Curved

CODE	DESCRIPTION	LENGTH
35-1145	Pointed Tips	7 in 178 mm



Bone Reduction Forceps

CODE	DESCRIPTION	LENGTH
35-1140	Curved, One Tip Pointed	6¾ in 170 mm



Forceps (Bone Reduction)

Bone Reduction Forceps

CODE	DESCRIPTION	LENGTH
35-1146	Curved	7 in 175 mm



Bone Reduction Forceps

CODE	DESCRIPTION	LENGTH
35-1148	Jaws Slightly Curved	5½ in 140 mm



Bone Reduction Forceps

CODE	DESCRIPTION	LENGTH
35-1149	Opens Jaws to 4 in, 2 in Ratchet	8 in 200 mm



Stagbeetle Bone Reduction Forceps

Curved

CODE	DESCRIPTION	LENGTH
35-1135	Pointed Tips	4¾ in 120 mm



Forceps (Bone Reposition)

Bone Reposition Forceps

CODE	DESCRIPTION	LENGTH
35-1113	Curved	5 1/8 in 130 mm



Forceps (Ligamentum Flavum)

Preston Ligamentum Flavum Forceps

CODE	DESCRIPTION	LENGTH
35-2165	Serrated, 1 x 2 Teeth	7 1/4 in 185 mm



Forceps (Malleolar)

Malleolar Forceps

CODE	DESCRIPTION	LENGTH
35-1134	1 x 1 Sharp Points	8 1/4 in 210 mm

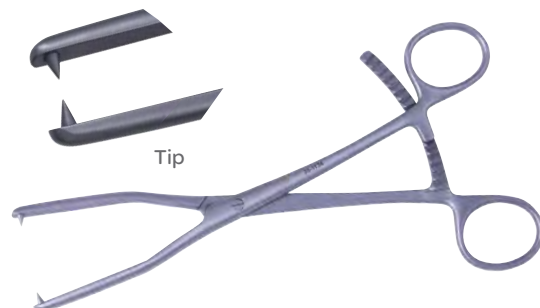

Forceps (Meniscus)

Cartilage & Meniscus Forceps

CODE	DESCRIPTION
35-2021	3 x 4 Teeth



Forceps (Pelvic)

Pelvic Reduction Forceps

CODE	LENGTH
35-1172	9 $\frac{7}{8}$ in 250 mm

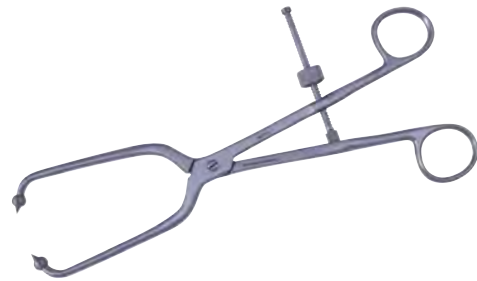

Pelvic Reduction Forceps

CODE	LENGTH
35-1173	16 in 405 mm



Forceps (Phalangeal)

Locke Phalangeal Forceps

CODE	DESCRIPTION	LENGTH
35-1111	Serrated, 1 x 2 Teeth	6 in 152 mm



Forceps (Screw Removal)

Forceps

CODE	DESCRIPTION
14-039-000	Screw Holding



Forceps (Sesamoidectomy)

Sesamoidectomy Clamp Forceps

CODE	DESCRIPTION	LENGTH
35-1120	Slightly Curved	6½ in 165 mm



Forceps (Synovectomy)

Synovectomy Forceps

CODE	DESCRIPTION	LENGTH
30-7617	With Rongeur Jaws, Ring Handle	5 in 125 mm



Forceps (Tendon)

Brand Tendon Forceps

CODE	DESCRIPTION	LENGTH
78-1115	Curved Jaw, 1 x 2 Teeth	6 in 150 mm
78-1119	Curved Jaw, 1 x 2 Teeth	7½ in 190 mm

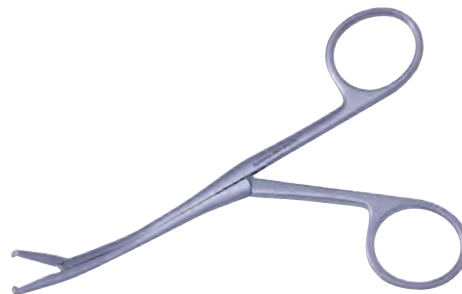

78-1115

Gouges (Acetabular)

Acetabular Gouge

CODE	TIP	WIDTH
10-057-000	48 mm	½ in
10-058-000	52 mm	½ in
10-059-000	56 mm	½ in



10-057-00

Gouges (Arthroscopic)

Gouge

CODE	DESCRIPTION	WORKING DIAMETER	WORKING LENGTH
1010901	Straight	4.6 mm	115 mm
1010902	Compound Curve	4.6 mm	115 mm

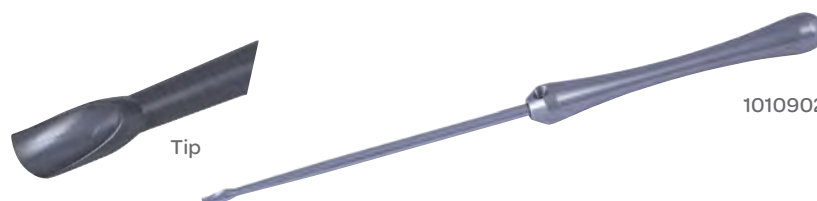

1010902

Gouges (Bone)

Alexander Gouge

CODE	TIP	LENGTH
28-2804	4 mm	7 in 178 mm
28-2806	6 mm	7 in 178 mm
28-2808	8 mm	7 in 178 mm
28-2814	14 mm	7 in 178 mm



28-2804

Bishop Gouge

CODE	TIP	LENGTH
27-6063	3 mm	6 in 150 mm

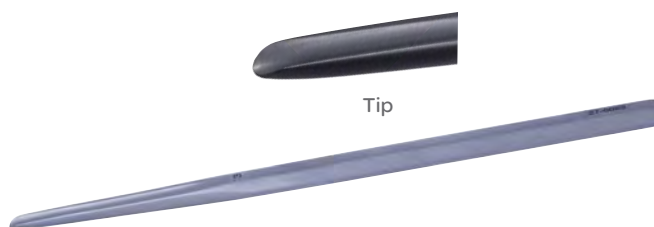

Tip

Bone Gouge

CODE	DESCRIPTION	TIP WIDTH	LENGTH
32-2000	Straight	¼ in 6 mm	11 in 279 mm
32-2001	Straight	⅜ in 10 mm	11 in 279 mm
32-2002	Straight	½ in 13 mm	11 in 279 mm
32-2003	Straight	⅝ in 16 mm	11 in 279 mm
32-2004	Straight	¾ in 19 mm	11 in 279 mm
32-2005	Straight	1 in 25 mm	11 in 279 mm
32-2006	Straight	1¼ in 32 mm	11 in 279 mm
32-2010	Curved	¼ in 6 mm	11 in 279 mm
32-2011	Curved	⅜ in 10 mm	11 in 279 mm
32-2012	Curved	½ in 13 mm	11 in 279 mm
32-2013	Curved	⅝ in 16 mm	11 in 279 mm
32-2014	Curved	¾ in 19 mm	11 in 279 mm
32-2015	Curved	1 in 25 mm	11 in 279 mm
32-2016	Curved	1¼ in 32 mm	11 in 279 mm

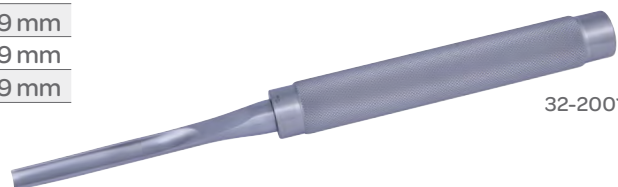

32-2001

Gouges (Bone)

Gouge

CODE	DESCRIPTION	TIP	LENGTH	
43-4077	Pointed Tip	$\frac{1}{16}$ in 2 mm	5 in	125 mm



Hibbs Gouge

CODE	DESCRIPTION	TIP WIDTH		LENGTH	
28-5206	Straight	$\frac{1}{4}$ in	6 mm	9 $\frac{1}{2}$ in	241 mm
28-5210	Straight	$\frac{3}{8}$ in	10 mm	9 $\frac{1}{2}$ in	241 mm
28-5212	Straight	$\frac{1}{2}$ in	13 mm	9 $\frac{1}{2}$ in	241 mm
28-5216	Straight	$\frac{5}{8}$ in	16 mm	9 $\frac{1}{2}$ in	241 mm
28-5220	Straight	$\frac{3}{4}$ in	19 mm	9 $\frac{1}{2}$ in	241 mm
28-5225	Straight	1 in	25 mm	9 $\frac{1}{2}$ in	241 mm
28-5240	Straight	1 $\frac{1}{2}$ in	38 mm	9 $\frac{1}{2}$ in	241 mm
28-5256	Curved	$\frac{1}{4}$ in	6 mm	9 $\frac{1}{2}$ in	241 mm
28-5260	Curved	$\frac{3}{8}$ in	10 mm	9 $\frac{1}{2}$ in	241 mm
28-5262	Curved	$\frac{1}{2}$ in	13 mm	9 $\frac{1}{2}$ in	241 mm
28-5266	Curved	$\frac{5}{8}$ in	16 mm	9 $\frac{1}{2}$ in	241 mm
28-5270	Curved	$\frac{3}{4}$ in	19 mm	9 $\frac{1}{2}$ in	241 mm
28-5275	Curved	1 in	25 mm	9 $\frac{1}{2}$ in	241 mm
28-5280	Curved	1 $\frac{1}{8}$ in	30 mm	9 $\frac{1}{2}$ in	241 mm
28-5290	Curved	1 $\frac{1}{2}$ in	38 mm	9 $\frac{1}{2}$ in	241 mm



28-5210

Lexer Gouge

CODE	DESCRIPTION	TIP	LENGTH	
28-5301		$\frac{3}{16}$ in 5 mm	7 in	175 mm

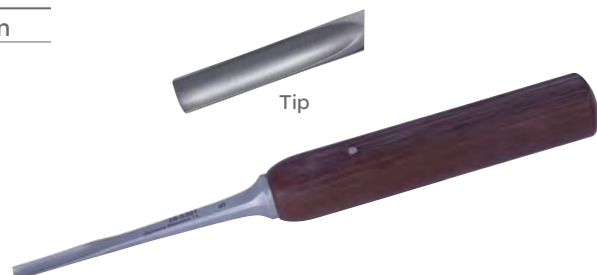

Gouges (Bone)

Smith-Peterson Bone Gouge

CODE	DESCRIPTION	TIP WIDTH	LENGTH
32-2540	Straight	¼ in 6 mm	8 in 203 mm
32-2541	Straight	⅜ in 10 mm	8 in 203 mm
32-2542	Straight	½ in 12 mm	8 in 203 mm
32-2543	Straight	⅝ in 16 mm	8 in 203 mm
32-2544	Straight	¾ in 20 mm	8 in 203 mm
32-2545	Straight	1 in 25 mm	8 in 203 mm
28-7230	Straight	1⅛ in 30 mm	8 in 200 mm
32-2546	Straight	1¼ in 32 mm	8 in 203 mm
32-2550	Curved	¼ in 6 mm	8 in 203 mm
32-2551	Curved	⅜ in 10 mm	8 in 203 mm
32-2552	Curved	½ in 12 mm	8 in 203 mm
32-2553	Curved	⅝ in 16 mm	8 in 203 mm
32-2554	Curved	¾ in 20 mm	8 in 203 mm
32-2555	Curved	1 in 25 mm	8 in 203 mm
28-7280	Curved	1⅛ in 30 mm	8 in 200 mm
32-2556	Curved	1¼ in 32 mm	8 in 203 mm



32-2501

Stille Gouge

CODE	DESCRIPTION	TIP	LENGTH
28-4512	Straight	½ in 12 mm	8 in 203 mm
28-4515	Straight	⅞ in 15 mm	8 in 203 mm
28-4525	Straight	1 in 25 mm	8 in 203 mm

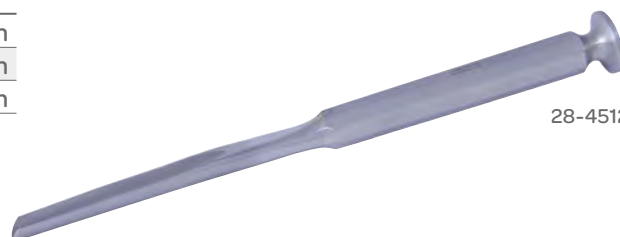

28-4512

Swan Neck Gouge

CODE	LENGTH
28-6255	9 in 229 mm



Graspers (Arthroscopic)

Joint Grasper

Straight

CODE	DESCRIPTION
1030301	Small



Suture Grasper

CODE
1020304



Handles (Impaction)

Impaction Handle

CODE	DESCRIPTION
10-148-000	Modular Cement

* For use with Tibial Perforator on O/A-3



Handles (Quick-Coupling)

Quick-Coupling Handle

Two Per Set

CODE	DESCRIPTION
10-020-000	For Flexible Osteotome Blades on page O/A-63



Handles (Ratcheting)

Black Mini Ratcheting Handle

CODE	DESCRIPTION
15-043-101	Square Drive, 1/4 in



Hooks

Hook

CODE	DESCRIPTION	LENGTH
77-1505	Sharp	6 in 151 mm



Crochet Hook

CODE
1021001



Hooks (Bone)

Bone Hook

CODE	DESCRIPTION	HOOK DIAMETER	LENGTH
32-3422	Large-Sharp	60 mm	8 1/2 in 216 mm
32-3423	Heavy Duty-Sharp	19 mm	9 in 229 mm
32-3425	Heavy Duty-Sharp	30 mm	9 in 229 mm
32-3424	Heavy Duty-Blunt	19 mm	9 in 229 mm



Hooks (Bone)

Bone Hook

Grip Handle

CODE	DESCRIPTION	TIP	LENGTH
77-1010	Sharp	10 mm	7½ in 191 mm
77-1020	Sharp	20 mm	7½ in 191 mm
77-1028	Sharp	13 mm	9 in 229 mm
77-1029	Sharp	22 mm	9 in 229 mm
77-1030	Sharp	30 mm	9 in 229 mm



77-1010

Bone Hook

T-Handle

CODE	DESCRIPTION	LENGTH
77-1032	Sharp, Stainless Steel	7 in 178 mm
77-1035	Sharp	11 in 279 mm



77-1032

Volkman Bone Hook

CODE	DESCRIPTION	LENGTH
77-1040	Sharp	8 in 203 mm
77-1044	Sharp	9 in 229 mm
77-1041	Blunt	9 in 229 mm



77-1040

Hooks (Cement Removal)

Crochet Hook

CODE
10-056-000



Impactors (Bone Graft)

Bone Graft Impactor & Holder

CODE	DIMENSIONS
28-1003	8 ¾ in 222 mm



Cloward Graft Impactor

Double-Ended

CODE	END DIAMETERS	LENGTH
77-2014	7/16 in 11 mm 9/16 in 14 mm	8 ¼ in 210 mm



Graft Impactor

Double-Ended

CODE	END DIAMETER	LENGTH
28-1000	7/16 in 11 mm 9/16 in 14 mm	8 ¾ in 222 mm



MultiPak Bone Impactor

CODE	DESCRIPTION	DIMENSIONS
52-5280	Replaceable Nylon Cap	6 ½ in 165 mm

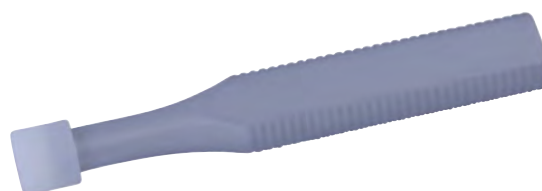

Impactors (Prosthesis)

Component Impactor

CODE
10-016-000



Kits (Calcar Driver)

Complete 1.5 in Calcar Driver Set

Complete set included one modular calcar planer, one disposable calcar blade and one calcar driver wrench

CODE	DESCRIPTION
30-041-000	TR-Shank End



Kits (FlashPak® Refurbish)

FlashPak® Refurbish Kit

CODE	DESCRIPTION
9000-09	9020-09(2), 9020-11(1)

Kits (Flexible Osteotome)



Flexible Osteotome System Complete

CODE	DESCRIPTION	QTY
30-005-000	Flexible Osteotome System Complete Includes the Following:	
10-020-000	Quick-Coupling Handle for Flex Osteotomes	2
12-007-000	Small Slap Hammer	1
11-002-000	Thin Osteotome Blade, 8 mm x 3 in	1
11-003-000	Thin Osteotome Blade, 10 mm x 3 in	1
11-004-000	Thin Osteotome Blade, 12 mm x 3 in	1
11-005-000	Thin Osteotome Blade, 20 mm x 3 in	1
11-006-000	Thin Osteotome Blade, Curved End, 12 mm	1
11-007-000	Thin Osteotome Blade, Curved End, 20 mm	1
11-008-000	Thin Osteotome Blade, 8 mm x 5 in	1
11-009-000	Thin Osteotome Blade, 10 mm x 5 in	1
25-005-000	Metal Case	1

Kits (Hip Revision)



Complete Extractor Tray

CODE	DESCRIPTION	QTY
30-035-000	Complete Extractor Tray Includes the Following:	
12-001-000	Femoral Extractor Slaphammer	1
12-031-000	Universal Modular Hip Stem Extractor	1
12-004-000	One-Piece Stem Adapter	1
12-029-000	Closed Loop Extractor	1
12-030-000	Hook Stem Extractor	1
25-022-000	Metal Case	1

Kits (Hip Retractor)

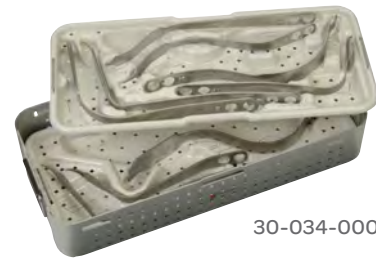

30-034-000

Complete Hip Retractor System

CODE	DESCRIPTION	QTY
30-034-000	Set Includes the Following:	
13-023-000	Hip Retractor, 25 mm Blade	1
13-024-000	Hip Retractor, Blunt Tip	1
13-025-000	Offset Retractor, 32 mm Blade	1
13-026-000	Long Hohmann	1
13-027-000	Long Hohmann, Curved, Short Blade	1
13-028-000	Long Hohmann, Curved, Long Blade	1
13-029-000	Long Hohmann, Narrow	1
13-030-000	Small Hohmann Part	1
13-031-000	Femoral Elevator	1
25-028-000	Hybrid Case	1

Kits (Karlin™ Curved Stiletto Osteotome)



46-3050

Karlin™ Curved Stiletto Osteotome Set

CODE	DESCRIPTION	LENGTH
46-3050	Karlin™ Curved Stiletto Osteotome Set With Case, Includes the Following Items:	
46-3051	Curved	¼ in 6 mm 8½ in 216 mm
46-3052	Curved	⅜ in 10 mm 8½ in 216 mm
46-3053	Curved	½ in 13 mm 8½ in 216 mm
46-3054	Curved	⅝ in 16 mm 8½ in 216 mm
46-3055	Curved	¾ in 19 mm 8½ in 216 mm
46-3056	Case For curved stiletto osteotome	

Kits (Knee Retractor)

Knee Retractor System

Includes Hohmann, Collateral, Patellar, Superior, Condylar and Soft Tissue Retractors

CODE	DESCRIPTION
30-032-000	Minimally Invasive



Kits (MultiPak Metal Carrying Handle)

MultiPak Metal Carrying Handle Kit

CODE	DESCRIPTION
5130	For 5000-01, 5010-03 and 5022-03

Our Values

- We are passionate about our mission to improve patient outcomes.
- We are dedicated to delivering exceptional quality and service.
- We are collaborative with our customers, responding directly to clinician and provider needs with new innovations that help deliver superior patient care.

Customer Focus

Whether you're a purchasing agent, nurse or surgeon, our goal is to develop a collaborative, service-oriented relationship that will allow us to meet all of your needs. Clinically trained as professional instrument specialists, our sales representatives are available locally to assist you with any instrument-related needs – including product checkups.

Kits (Screw Removal)

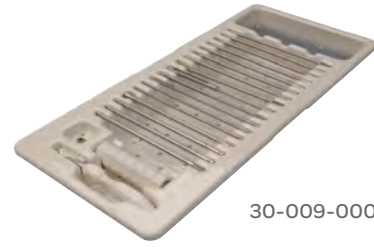

30-009-000

Complete Screw Removal System

CODE	DESCRIPTION
30-009-000	System Includes One (1) Each of the Following:
10-128-000	1.5 mm Screw Extractor
10-116-000	2.5 mm Screw Extractor
10-130-000	3.5 mm Screw Extractor
10-117-000	1.5 mm Hex Driver
10-114-000	2.5 mm Hex Driver
10-115-000	3.5 mm Hex Driver
10-132-000	4.0 mm Hex Driver
10-133-000	5.0 mm Hex Driver
10-119-000	Small Cruciform Screwdriver
10-141-000	Mini Cruciform Screwdriver
10-120-000	Straight Screwdriver
10-127-000	Universal Extractor
10-127-001	Large Extraction Bolt Body
10-127-003	Small Extraction Bolt
10-129-000	Fracture Pick
10-121-000	2.2 mm Trephine
10-122-000	3.2 mm Trephine
10-123-000	4.2 mm Trephine
10-125-000	7.2 mm Trephine
10-113-000	Universal Driver Handle
10-121-010	Radel® R Case

Kits (Stiletto Chisel)



46-3080

Karlin™ Curved Stiletto Chisel Set with Case

CODE	DESCRIPTION	TIP SIZE
46-3080	Set Includes One (1) Each of the Following:	
46-3081	Chisel Curved	¼ in 6 mm
46-3082	Chisel Curved	⅜ in 10 mm
46-3083	Chisel Curved	½ in 13 mm
46-3084	Chisel Curved	⅝ in 16 mm
46-3085	Chisel Curved	¾ in 19 mm
46-3086	Case For Straight Stiletto Chisel Set	

Kits (Stiletto Chisel)

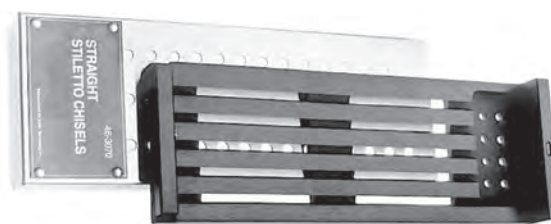

Karlin™ Straight Stiletto Chisel Set With Case

46-3070

CODE	DESCRIPTION	TIP SIZE
46-3070	Set Includes One (1) Each of the Following:	
46-3071	Chisel Straight	¼ in 6 mm
46-3072	Chisel Straight	⅜ in 10 mm
46-3073	Chisel Straight	½ in 13 mm
46-3074	Chisel Straight	⅝ in 16 mm
46-3075	Chisel Straight	¾ in 19 mm
46-3076	Case For Straight Stiletto Chisel Set	

Kits (Tibial Impaction)



30-026-000

Complete Tibial Impaction System

CODE	DESCRIPTION
30-026-000	Set Includes One (1) Each of the Following:
	Small Tibial Perforator
	Medium Tibial Perforator
	Large Tibial Perforator
	Small Cement Well
	Medium Cement Well
	Large Cement Well
	Small Compression Base
	Medium Compression Base
	Large Compression Base
	Modular Cement Impaction Handle
	Small Slap Hammer
	Radel® R Case

Kits (Trepine)

Complete Trepine Tray

CODE	DESCRIPTION
30-014-000	Set Includes One (1) Each of the Following:
12-028-000	Slap Hammer Shaft
10-023-000	Quick Connect T-Handle
10-062-000	T-Bar Stem Extractor
10-075-000	Wrench
10-063-000	Trepine 11 mm ID x 8 in
10-064-000	Trepine 12 mm ID x 8 in
10-065-000	Trepine 13 mm ID x 8 in
10-066-000	Trepine 14 mm ID x 8 in
10-067-000	Trepine 15 mm ID x 8 in
10-068-000	Trepine 16 mm ID x 8 in
10-069-000	Trepine 17 mm ID x 8 in
10-070-000	Trepine 18 mm ID x 8 in
10-071-000	Trepine 19 mm ID x 8 in
10-072-000	Trepine 20 mm ID x 8 in
10-073-000	Trepine 21 mm ID x 8 in
10-074-000	Trepine 22 mm ID x 8 in
10-099-000	Trepine 23 mm ID x 8 in
10-101-000	Trepine 24 mm ID x 8 in
25-023-000	Metal Case

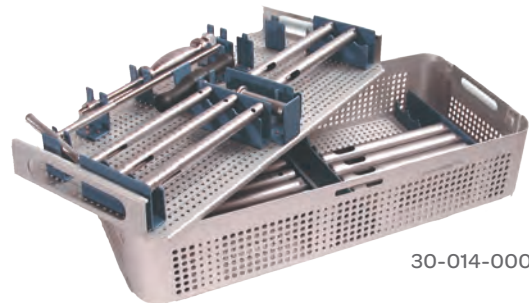

30-014-000

Kits (Universal Shoulder Arthroplasty)

Complete Universal Arthroplasty System

CODE	DESCRIPTION
30-024-000	Set Includes One (1) Each of the Following:
13-002-000	Modified Bankhart Retractor
13-003-000	Deltoid Retractor
13-004-000	Conjoined Tendon Retractor
13-005-000	Humeral Head Dislocator
13-006-000	Humeral Retractor
13-047-000	Hohmann Retractor
25-019-000	Radel® R Case Part



Knives (Arthroscopic)

Knife

Straight

CODE	DESCRIPTION	WORKING DIAMETER	WORKING LENGTH
1010602	Banana, Serrated	5 mm	114 mm
1010601	Hook	5 mm	112 mm
1010603	Meniscotome, Y-Shaped	5 mm	111 mm



Mallets

Collin Lucae Bone Mallet

CODE	HEAD	WEIGHT	LENGTH
27-0422	Solid, 1¼ in	7½ oz 212 g	8 in 200 mm



Gerzog Mallet

Lead-Filled Head

CODE	HEAD	WEIGHT	LENGTH
27-0840	1 in 25 mm	10 oz 283 g	7 in 178 mm

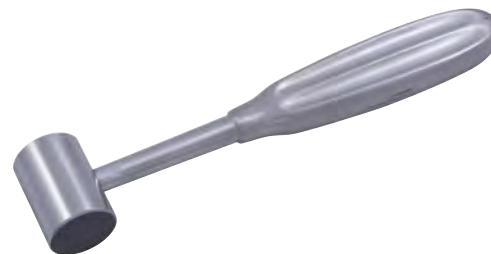

Hajek Bone Mallet

Solid

CODE	HEAD	WEIGHT	LENGTH
27-0420	1 in 25 mm	6½ oz 184 g	8¼ in 210 mm

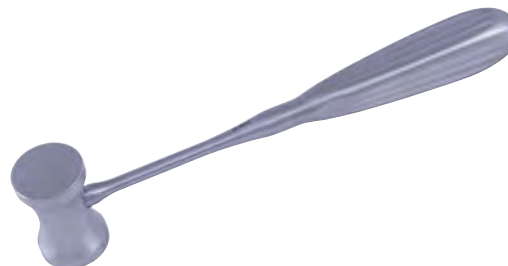

Mallets

Heath Heavyweight Mallet

CODE	HEAD	WEIGHT	LENGTH
27-0880	1½ in 38 mm	2 lb 907 g	7½ in 191 mm



Heath Mallet

CODE	HEAD	WEIGHT	LENGTH
32-3330	2½ x 1½ in 64 x 38 mm	2 lb 907 g	7¼ in 184 mm

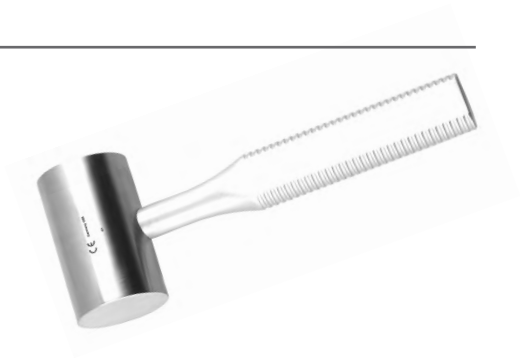

Hibbs Mallet

Solid Brass Head

CODE	HEAD	WEIGHT	LENGTH
88-2520	1½ in 38 mm	12 oz 340 g	8 in 203 mm



Mallets

Karlin™ Mallet

CODE	HEAD	WEIGHT	DIMENSIONS
46-3179	Small 1 in 25 mm	7.1 oz 200 g	9½ in 241 mm
46-3146	Large 1¼ in 32 mm	12 oz 340 g	9¾ in 247 mm



46-3146

Kirk Mallet

Bronze Head

CODE	HEAD	WEIGHT	LENGTH
27-0870	1½ in 38 mm	1lb, 7 oz 652 g	7½ in 191 mm



Mallet

CODE	DESCRIPTION	LENGTH
63-0206	One Side Nylon Cap	7½ in 191 mm
63-0207	Replacement Nylon Caps For 63-0205 & 63-0206, Pack of 2	

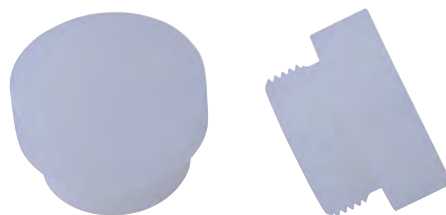

Mallet

CODE	DESCRIPTION	LENGTH
63-0205	With Nylon Replaceable Caps	7½ in 191 mm

Mallets

Mallet

CODE	DESCRIPTION	LENGTH
63-0200	Small, Copper	6½ in 165 mm

Mallet

CODE	DESCRIPTION	WEIGHT	LENGTH
27-0213	Small	5 oz 141 g	6½ in 165 mm

Mallet

CODE	HEAD	WEIGHT	LENGTH
27-0400	1¾ in 35 mm	1 lb 453 g	7¼ in 184 mm
27-0401	1½ in 38 mm	2 lb 907 g	7¾ in 195 mm



27-0400

Mead Mallet

CODE	WEIGHT	LENGTH
27-0630	11 oz 340 g	7½ in 191 mm

Mallets

Orthopedic Mallet

CODE	HEAD	WEIGHT	LENGTH
27-0866	1½ in 38 mm	1lb 453 g	10¾ in 273 mm
27-0899	1⅞ in 48 mm	3lb 1360 g	10¾ in 273 mm

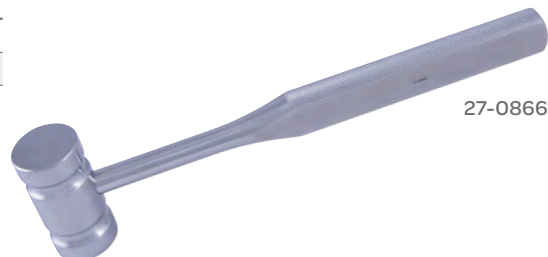

27-0866

Slotted Mallet

CODE	DESCRIPTION
10-102-000	Delrin Cap



Small Mallet

Solid Brass Head

CODE	HEAD	WEIGHT	LENGTH
88-2500	1½ in 38 mm	15 oz 420 g	7 in 178 mm



Wagner Mallet

CODE	DIMENSIONS
63-0208	9¼ in 235 mm

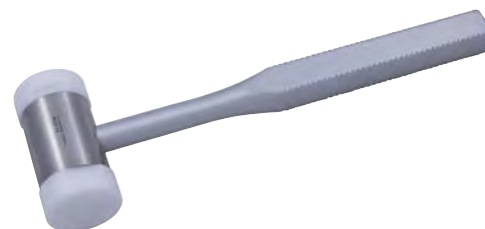

Mallets

Wagner Mallet Replacement Caps

For Use with 63-0208

CODE	DESCRIPTION
63-0208C	Set of 2

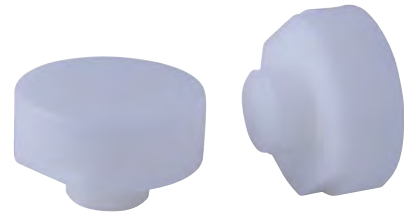

Manipulators (Arthroscopic)

Suture Manipulator

CODE
1020303



Tip

Osteotomes

Cobb Osteotome

CODE	DESCRIPTION	WIDTH	LENGTH
28-7020	Straight	¼ in 6 mm	11 in 279 mm
28-7021	Straight	⅜ in 10 mm	11 in 279 mm
28-7022	Straight	½ in 13 mm	11 in 279 mm
28-7023	Straight	⅝ in 16 mm	11 in 279 mm
28-7024	Straight	¾ in 19 mm	11 in 279 mm
28-7025	Straight	1 in 25 mm	11 in 279 mm
28-7028	Curved	⅜ in 10 mm	11 in 279 mm
28-7029	Curved	½ in 13 mm	11 in 279 mm
28-7030	Curved	⅝ in 16 mm	11 in 279 mm
28-7031	Curved	¾ in 19 mm	11 in 279 mm
28-7032	Curved	1 in 25 mm	11 in 279 mm
28-7033	Curved	1¼ in 32 mm	11 in 279 mm



28-7028

Osteotomes

Flexible Osteotome Blade

See page O/A-46 for Quick-Coupling Handle

CODE	DESCRIPTION	BLADE WIDTH	LENGTH
11-002-000	Thin Osteotome Blade	$\frac{1}{3}$ in 8 mm	3 in 76 mm
11-003-000	Thin Osteotome Blade	$\frac{3}{8}$ in 10 mm	3 in 76 mm
11-004-000	Thin Osteotome Blade	$\frac{1}{2}$ in 13 mm	3 in 76 mm
11-005-000	Thin Osteotome Blade	$\frac{13}{16}$ in 20 mm	3 in 76 mm
11-008-000	Thin Osteotome Blade	$\frac{3}{8}$ in 8 mm	5 in 127 mm
11-009-000	Thin Osteotome Blade	$\frac{3}{8}$ in 10 mm	5 in 127 mm
11-031-000	Flexible	$\frac{1}{3}$ in 8 mm	5 in 127 mm
11-032-000	Flexible	$\frac{3}{8}$ in 10 mm	5 in 127 mm
11-030-000	Flexible	$\frac{3}{4}$ in 19 mm	5 in 127 mm
11-006-000	Curved End	$\frac{1}{2}$ in 13 mm	5 in 127 mm
11-007-000	Curved End	$\frac{3}{4}$ in 20 mm	5 in 127 mm
11-020-000	Radial	$\frac{1}{2}$ in 13 mm	5 in 127 mm



Flexible Osteotome Blade

CODE	DESCRIPTION	BLADE WIDTH	LENGTH
11-033-000	Radial	$\frac{3}{8}$ in 10 mm	5 in 127 mm
11-029-000	Radial	$\frac{7}{16}$ in 12 mm	5 in 127 mm
11-034-000	Radial	$\frac{1}{2}$ in 13 mm	5 in 127 mm
11-021-000	Radial	$\frac{5}{8}$ in 16 mm	5 in 127 mm
11-022-000	Radial	$\frac{3}{4}$ in 19 mm	5 in 127 mm

Osteotomes



28-5156

Hibbs Osteotome

CODE	DESCRIPTION	WIDTH	LENGTH
28-5106	Straight	¼ in 6 mm	9½ in 241 mm
28-5110	Straight	⅜ in 10 mm	9½ in 241 mm
28-5112	Straight	½ in 13 mm	9½ in 241 mm
28-5116	Straight	⅝ in 16 mm	9½ in 241 mm
28-5120	Straight	¾ in 19 mm	9½ in 241 mm
28-5122	Straight	⅞ in 22 mm	9½ in 241 mm
28-5125	Straight	1 in 25 mm	9½ in 241 mm
28-5130	Straight	1⅛ in 29 mm	9½ in 241 mm
28-5132	Straight	1¼ in 32 mm	9½ in 241 mm
28-5140	Straight	1½ in 38 mm	9½ in 241 mm
28-5156	Curved	¼ in 6 mm	9½ in 241 mm
28-5160	Curved	⅜ in 10 mm	9½ in 241 mm
28-5162	Curved	½ in 13 mm	9½ in 241 mm
28-5166	Curved	⅝ in 16 mm	9½ in 241 mm
28-5170	Curved	¾ in 19 mm	9½ in 241 mm
28-5172	Curved	⅞ in 22 mm	9½ in 241 mm
28-5175	Curved	1 in 25 mm	9½ in 241 mm
28-5180	Curved	1⅛ in 29 mm	9½ in 241 mm
28-5182	Curved	1¼ in 32 mm	9½ in 241 mm
28-5190	Curved	1½ in 38 mm	9½ in 241 mm



32-3438

Hoke Osteotome

CODE	DESCRIPTION	BLADE WIDTH	LENGTH
32-3439	Straight	0.3 mm	6 in 152 mm
32-3435	Straight	0.6 mm	6 in 152 mm
32-3436	Straight	1 mm	6 in 152 mm
32-3437	Straight	1.3 mm	6 in 152 mm
32-3438	Straight	1.6 mm	6 in 152 mm
32-3430	Curved	0.3 mm	6 in 152 mm
32-3431	Curved	0.6 mm	6 in 152 mm
32-3433	Curved	1 mm	6 in 152 mm
32-3432	Curved	1.3 mm	6 in 152 mm
32-3434	Curved	1.6 mm	6 in 152 mm

Osteotomes



Tip

28-4953

Hoke Osteotome

CODE	DESCRIPTION	BLADE WIDTH		LENGTH	
28-4903	Straight	1/8 in	3 mm	5 1/2 in	140 mm
28-4904	Straight	3/16 in	5 mm	5 1/2 in	140 mm
28-4906	Straight	1/4 in	6 mm	5 1/2 in	140 mm
28-4908	Straight	5/16 in	8 mm	5 1/2 in	140 mm
28-4910	Straight	3/8 in	10 mm	5 1/2 in	140 mm
28-4912	Straight	1/2 in	13 mm	5 1/2 in	140 mm
28-4953	Curved	1/8 in	3 mm	5 1/2 in	140 mm
28-4954	Curved	3/16 in	5 mm	5 1/2 in	140 mm
28-4956	Curved	1/4 in	6 mm	5 1/2 in	140 mm
28-4958	Curved	5/16 in	8 mm	5 1/2 in	140 mm
28-4960	Curved	3/8 in	10 mm	5 1/2 in	140 mm
28-4962	Curved	1/2 in	13 mm	5 1/2 in	140 mm

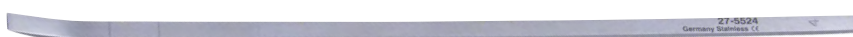

27-5524

Lambotte Osteotome

CODE	DESCRIPTION	CALIBRATION LINES		LENGTH	
27-5502	Straight	1/16 in	2 mm	7 1/4 in	185 mm
27-5504	Straight	1/8 in	4 mm	7 1/4 in	185 mm
27-5505	Straight	3/16 in	5 mm	7 1/4 in	185 mm
27-5506	Straight	1/4 in	6 mm	7 1/4 in	185 mm
27-5508	Straight	5/16 in	8 mm	7 1/4 in	185 mm
27-5510	Straight	3/8 in	10 mm	7 1/4 in	185 mm
27-5512	Straight	7/16 in	12 mm	7 1/4 in	185 mm
27-5516	Straight	5/8 in	16 mm	7 1/4 in	185 mm
27-5519	Straight	3/4 in	19 mm	7 1/4 in	185 mm
27-5522	Straight	7/8 in	22 mm	7 1/4 in	185 mm
27-5524	Curved	1/8 in	4 mm	7 1/4 in	185 mm
27-5526	Curved	1/4 in	6 mm	7 1/4 in	185 mm

Osteotomes



28-9412

Lambotte Osteotome

Without Calibration Lines

CODE	DESCRIPTION	BLADE WIDTH	LENGTH
28-9406	Straight	$\frac{1}{4}$ in 6 mm	9 in 228 mm
28-9412	Straight	$\frac{1}{2}$ in 13 mm	9 in 228 mm
28-9420	Straight	$\frac{3}{4}$ in 19 mm	9 in 228 mm
28-9430	Straight	$1\frac{1}{4}$ in 32 mm	9 in 228 mm
28-9440	Straight	$1\frac{1}{2}$ in 38 mm	9 in 228 mm



27-5702

Mini-Lambotte Osteotome

Swiss Pattern

CODE	DESCRIPTION	BLADE WIDTH	LENGTH
27-5702	Straight	$\frac{1}{16}$ in 2 mm	$5\frac{1}{8}$ in 130 mm
27-5704	Straight	$\frac{1}{8}$ in 4 mm	$5\frac{1}{8}$ in 130 mm
27-5706	Straight	$\frac{1}{4}$ in 6 mm	$5\frac{1}{8}$ in 130 mm
27-5708	Straight	$\frac{1}{3}$ in 8 mm	$5\frac{1}{8}$ in 130 mm
27-5710	Straight	$\frac{3}{8}$ in 10 mm	$5\frac{1}{8}$ in 130 mm
27-5712	Straight	$\frac{7}{16}$ in 12 mm	$5\frac{1}{8}$ in 130 mm
27-5714	Straight	$\frac{9}{16}$ in 14 mm	$5\frac{1}{8}$ in 130 mm
27-5715	Straight	$\frac{5}{8}$ in 15 mm	$5\frac{1}{8}$ in 130 mm
27-5718	Straight	$\frac{11}{16}$ in 18 mm	$5\frac{1}{8}$ in 130 mm
27-5719	Straight	$\frac{3}{4}$ in 19 mm	$5\frac{1}{8}$ in 130 mm
27-5720	Straight	$\frac{13}{16}$ in 20 mm	$5\frac{1}{8}$ in 130 mm

Osteotomes

Osteotome

CODE	DESCRIPTION	BLADE WIDTH	LENGTH
28-4410	Straight	$\frac{3}{8}$ in 10 mm	8 in 200 mm
28-4414	Straight	$\frac{9}{16}$ in 14 mm	8 in 200 mm
28-4418	Straight	$\frac{3}{4}$ in 18 mm	8 in 200 mm
28-4422	Straight	$\frac{7}{8}$ in 22 mm	8 in 200 mm



28-4404

Osteotome

CODE	DESCRIPTION	WIDTH
10-017-000	Straight	7 mm
10-018-000	Straight	12.5 mm
10-019-000	Straight	20 mm
10-008-000	Straight	7 mm x 17 in



10-018-00

Osteotome

CODE	DESCRIPTION	TIP SIZE	LENGTH
46-2000	Straight	$\frac{1}{4}$ in 6 mm	11 in 279 mm
46-2001	Straight	$\frac{3}{8}$ in 10 mm	11 in 279 mm
46-2002	Straight	$\frac{1}{2}$ in 13 mm	11 in 279 mm
46-2003	Straight	$\frac{5}{8}$ in 16 mm	11 in 279 mm
46-2004	Straight	$\frac{3}{4}$ in 19 mm	11 in 279 mm
46-2005	Straight	1 in 25 mm	11 in 279 mm
46-2006	Straight	1 $\frac{1}{4}$ in 32 mm	11 in 279 mm
46-2010	Curved	$\frac{1}{4}$ in 6 mm	11 in 279 mm
46-2011	Curved	$\frac{3}{8}$ in 10 mm	11 in 279 mm
46-2012	Curved	$\frac{1}{2}$ in 13 mm	11 in 279 mm
46-2013	Curved	$\frac{5}{8}$ in 16 mm	11 in 279 mm
46-2014	Curved	$\frac{3}{4}$ in 19 mm	11 in 279 mm
46-2015	Curved	1 in 25 mm	11 in 279 mm
46-2016	Curved	1 $\frac{1}{4}$ in 32 mm	11 in 279 mm



46-2006

Osteotomes

Osteotome

CODE	DESCRIPTION	TIP SIZE		LENGTH	
46-3051	Curved	¼ in	6 mm	8½ in	216 mm
46-3052	Curved	⅜ in	10 mm	8½ in	216 mm
46-3053	Curved	½ in	13 mm	8½ in	216 mm
46-3054	Curved	⅝ in	16 mm	8½ in	216 mm
46-3055	Curved	¾ in	19 mm	8½ in	216 mm



46-3052

Osteotome

CODE	DESCRIPTION	BLADE WIDTH		LENGTH	
46-1021	Straight	¼ in	6 mm	7½ in	191 mm
46-1025	Straight	¼ in	6 mm	9½ in	241 mm
46-1022	Straight	⅝ in	6 mm	9½ in	241 mm
46-1019	Straight	⅜ in	10 mm	9½ in	241 mm
46-1020	Curved	¼ in	6 mm	7½ in	191 mm
46-1026	Curved	¼ in	6 mm	9½ in	241 mm
46-1023	Slightly Curved	⅝ in	6 mm	9½ in	241 mm
46-1024	Full Curved	¼ in	6 mm	9½ in	241 mm

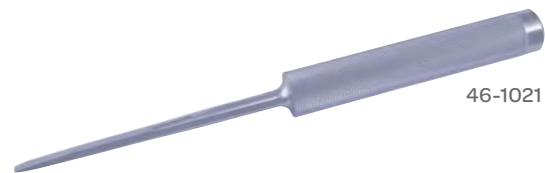

46-1021

Sheehan Osteotome

CODE	DESCRIPTION	BLADE WIDTH		LENGTH	
27-6202	Straight	⅛ in	2 mm	6¼ in	160 mm
27-6204	Straight	¼ in	4 mm	6¼ in	160 mm
27-6206	Straight	¼ in	6 mm	6¼ in	160 mm
27-6208	Straight	⅓ in	8 mm	6¼ in	160 mm
27-6210	Straight	⅜ in	10 mm	6¼ in	160 mm
27-6215	Straight	⅝ in	15 mm	6¼ in	160 mm
27-6218	Straight	¾ in	18 mm	6¼ in	160 mm



27-6202

Osteotomes

Smith-Peterson Osteotome

Blade Thickness $\frac{1}{6}$ in (2 mm)

CODE	DESCRIPTION	BLADE WIDTH	LENGTH
46-2500	Straight	$\frac{1}{4}$ in 6 mm	8 in 203 mm
46-2501	Straight	$\frac{3}{8}$ in 10 mm	8 in 203 mm
46-2502	Straight	$\frac{1}{2}$ in 13 mm	8 in 203 mm
46-2503	Straight	$\frac{5}{8}$ in 16 mm	8 in 203 mm
46-2504	Straight	$\frac{3}{4}$ in 19 mm	8 in 203 mm
46-2505	Straight	1 in 25 mm	8 in 203 mm
46-2506	Straight	$1\frac{1}{4}$ in 32 mm	8 in 203 mm
46-2510	Curved	$\frac{1}{4}$ in 6 mm	8 in 203 mm
46-2511	Curved	$\frac{3}{8}$ in 10 mm	8 in 203 mm
46-2512	Curved	$\frac{1}{2}$ in 13 mm	8 in 203 mm
46-2513	Curved	$\frac{5}{8}$ in 16 mm	8 in 203 mm
46-2514	Curved	$\frac{3}{4}$ in 19 mm	8 in 203 mm
46-2515	Curved	1 in 25 mm	8 in 203 mm
46-2516	Curved	$1\frac{1}{4}$ in 32 mm	8 in 203 mm

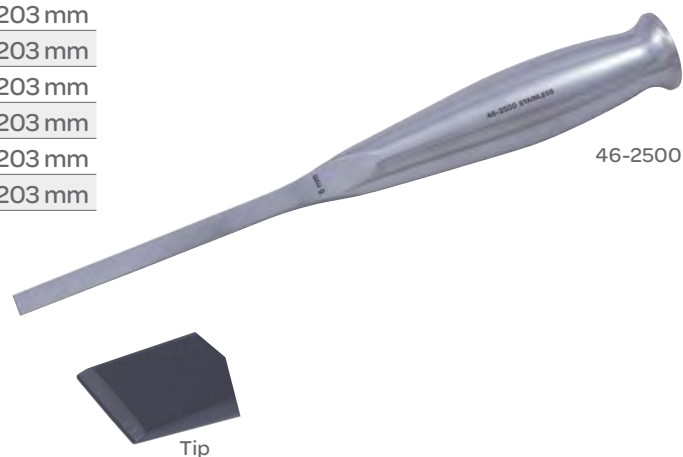

Smith-Peterson Osteotome

CODE	DESCRIPTION	BLADE WIDTH	LENGTH
28-7106	Straight	$\frac{1}{4}$ in 6 mm	8 in 203 mm
28-7112	Straight	$\frac{1}{2}$ in 13 mm	8 in 203 mm
28-7115	Straight	$\frac{5}{8}$ in 16 mm	8 in 203 mm
28-7120	Straight	$\frac{3}{4}$ in 19 mm	8 in 203 mm
28-7125	Straight	1 in 25 mm	8 in 203 mm
28-7130	Straight	$1\frac{1}{4}$ in 32 mm	8 in 203 mm
28-7156	Curved	$\frac{1}{4}$ in 6 mm	8 in 203 mm
28-7159	Curved	$\frac{3}{8}$ in 10 mm	8 in 203 mm
28-7162	Curved	$\frac{1}{2}$ in 13 mm	8 in 203 mm
28-7165	Curved	$\frac{5}{8}$ in 16 mm	8 in 203 mm
28-7175	Curved	1 in 25 mm	8 in 203 mm
28-7180	Curved	$1\frac{1}{4}$ in 32 mm	8 in 203 mm



Osteotomes

Stiletto Osteotome

CODE	DESCRIPTION	TIP SIZE	LENGTH
46-3061	Straight	¼ in 6 mm	8 ½ in 216 mm
46-3062	Straight	⅜ in 10 mm	8 ½ in 216 mm
46-3063	Straight	½ in 13 mm	8 ½ in 216 mm
46-3064	Straight	⅝ in 16 mm	8 ½ in 216 mm
46-3065	Straight	¾ in 19 mm	8 ½ in 216 mm



46-3061

US Army Osteotome

CODE	BLADE WIDTH	LENGTH
28-2106	¼ in 6 mm	6 ¼ in 160 mm
28-2112	⅜ in 12 mm	6 ¼ in 160 mm
28-2118	¾ in 18 mm	6 ¼ in 160 mm



28-2106

Picks

Pick

CODE	DESCRIPTION
10-129-000	Fracture Reduction



Plaster Tools (Shears)

Stille Plaster Shears

CODE	DESCRIPTION	LENGTH
40-5523	Stainless Steel	9 in 230 mm

Probes (Arthroscopic)

Probe

CODE	DESCRIPTION	TIP
1040501	Straight	
1010501		90°
1010502	Curved Left 30°	90°
1010503	Curved Right 30°	90°

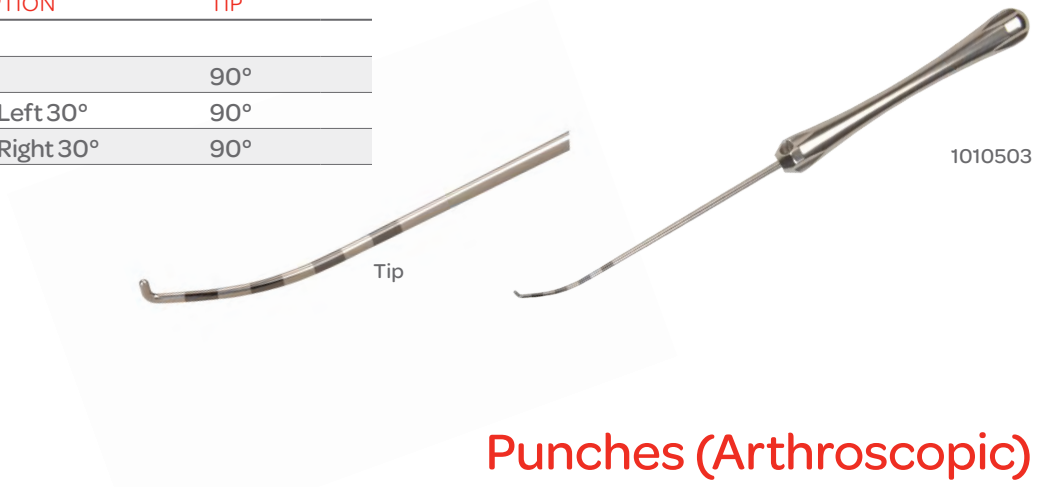

Punches (Arthroscopic)

Joint Punch

CODE	DESCRIPTION	LENGTH
1030101	Small	Teardrop, Straight
1030102	Small	Teardrop, Right 14°
1030103	Small	Left 14°



Knot Pusher

CODE
1020901

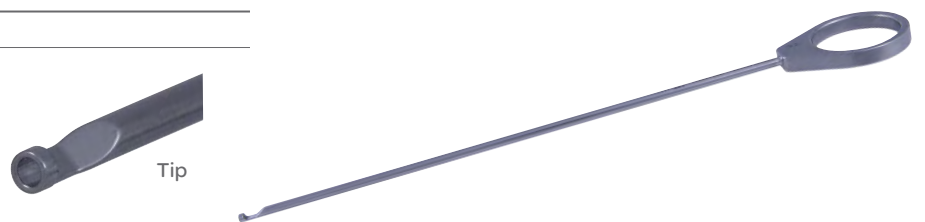

Punches (Arthroscopic)

Low Profile Punch

CODE	TIP	BITE WIDTH
1010101LP	Straight	1.7 mm
1010102LP	Up 15°	1.7 mm
1010138LP	Up 15°	2.6 mm
1010115LP	Up 15°	3.6 mm
1010117LP	Up 15°, Curved Left 15°	3.6 mm
1010119LP	Up 15°, Curved Right 15°	3.6 mm
1010131LP	Up 15°, Curved Up 15°	3.6 mm
1010139LP	Up 15°, Shaft Curved Up 15°	2.6 mm



1010101LP

Punch

90° Tip

CODE	DESCRIPTION	BITE WIDTH
1010128	Left, In-Line Handle	2.2 mm
1010125	Left, In-Line Handle	3.4 mm
1010129	Right In-Line Handle	2.2 mm
1010126	Right, In-Line Handle	
1010124	Left, Loop	3.2 mm
1010127	Right, Loop	3.2 mm



1010109

Punch

CODE	DESCRIPTION	WIDTH
1010122	Retro Left	2.4 mm
1010123	Retro Right	2.4 mm



1010122

Punches (Arthroscopic)

Punch

CODE	DESCRIPTION	BITE WIDTH
1000400	Straight Tip	0.8 mm
1010101	Straight Tip	1.7 mm
1010137	Straight Tip	2.6 mm
1010120	Straight	0.8 mm
1010113	Straight	3.6 mm
1040101	Straight	3.6 mm



Punch

CODE	DESCRIPTION	BITE WIDTH
1010111	Straight Tip, Blunt Nose	1.7 mm
1010134	Straight Tip, Short Nose	1.7 mm
1010112	Up 15° Tip, Blunt Nose	1.7 mm
1010135	Up 15° Tip, Short Nose	1.7 mm



Punch

Meniscal Lift

CODE	DESCRIPTION	BITE WIDTH
1010103	Straight	1.7 mm
1010114	Straight Tip	3.6 mm
1010116	Straight Tip	3.6 mm



Punches (Arthroscopic)

Punch

CODE	DESCRIPTION	BITE WIDTH
1010133	Straight Tip, Oval	3.6 mm



Punch

CODE	DESCRIPTION	BITE WIDTH
1010121	Up 15° Tip	0.8 mm
1000401	Up 15° Tip	0.8 mm
1010102	Up 15° Tip	1.7 mm
1010138	Up 15° Tip	2.6 mm

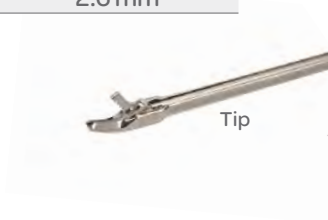

1010121

Punch

Up 15° Tip

CODE	DESCRIPTION	BITE WIDTH
1010105	Curved Left 15°	1.7 mm
1010107	Curved Right 15°	1.7 mm
1010109	Curved Up 15°	1.7 mm



1010105

Punches (Arthroscopic)

Punch

Up 15° Tip

CODE	DESCRIPTION	BITE WIDTH
1010104	Meniscal Lift	1.7 mm
1010106	Curved Left, Meniscal Lift	1.7 mm
1010108	Curved Right, Meniscal Lift	1.7 mm
1010110	Curved Up, Meniscal Lift	1.7 mm
1010118	Curved Left, Meniscal Lift	3.6 mm
1010130	Curved Right, Meniscal Lift	3.6 mm
1010132	Curved Up, Meniscal Lift	3.6 mm



Punch

Up 15° Tip

CODE	DESCRIPTION	BITE WIDTH
1010115	Straight Up 15°	3.6 mm
1010117	Curved Left 15°	3.6 mm
1010119	Curved Right 15°	3.6 mm
1010131	Curved Up 15°	3.6 mm
1010136	Round	5 mm



Punches (Micropunch)

Micropunch

CODE	DESCRIPTION
20-302	0°
20-342	45°



Rasps (Arthroscopic)

Rasp

CODE	DESCRIPTION	WORKING DIAMETER	WORKING LENGTH
1010701	Straight	4.6 mm	116 mm
1010702	Down Curve	6.1 mm	116 mm
1010703	Convex	6.1 mm	116 mm



Tip



1010703

Rasps (Bone)

Bone Rasp

Double-Ended

CODE	TIP	LENGTH
77-2004	#64, 3 and 4 mm	7 in 178 mm

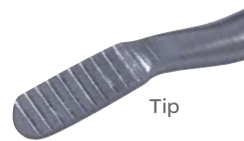

Tip

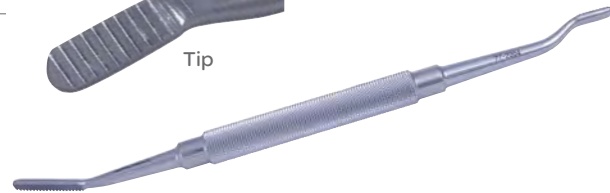

Putti Bone Rasp

Double-Ended

CODE	TIP	LENGTH
26-1501	Straight and Curved	10 1/2 in 267 mm
26-1502	Round and Half Round	12 in 305 mm

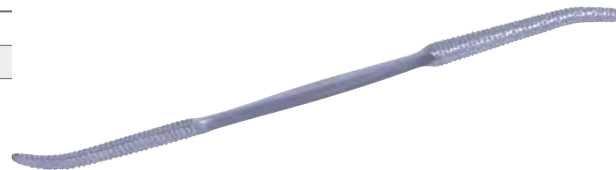

26-1502

Rasps (Nail)

Nail Rasp

Double-Ended, Angled with Serrations

CODE	TIP	LENGTH
77-2003	#93, 2 mm	6¾ in 170 mm

Polokoff Rasp

Double-Ended

CODE	TIP	LENGTH
77-2005	3 and 4 mm	8½ in 216 mm
77-2006	5 and 6 mm	8½ in 216 mm



Reamers (Intramedullary)

IM Reamer

CODE	DESCRIPTION
11-012-000	9 mm
11-013-000	10 mm
11-014-000	11 mm
11-015-000	12 mm
11-016-000	13 mm
11-017-000	15 mm
11-018-000	17 mm
11-019-000	19 mm



Retractors



77-1241

Aufranc Cobra Retractor

CODE	DESCRIPTION	TIP	LENGTH
77-1241	Smooth, Pointed Tip	10 mm	10 ½ in 265 mm
77-1242	Serrated, Blunt Tip	10 mm	10 ½ in 265 mm
77-1243	Smooth, Blunt Tip	10 mm	10 ½ in 265 mm



Bennett Bone Retractor

CODE	BLADE	LENGTH
77-1206	2 ½ in 65 mm	9 ½ in 240 mm



77-1251

Blount Hip Retractor

CODE	DESCRIPTION	BLADE	LENGTH
77-1251	Single Prong	1 ½ in 38 mm	10 in 254 mm
77-1252	Double Prong	2 ¾ in 44 mm	10 in 254 mm



Browne Deltoid Retractor

CODE	BLADE	LENGTH
77-1015	2 ¾ x 2 ½ in 60 x 65 mm	10 ¾ in 273 mm

Retractors



Bristow-Bankart Humeral Retractor

CODE	PRONGS	BLADE
77-1011	2, Blunt	25 x 102 mm



Capsule Retractor

CODE	DESCRIPTION	BLADE WIDTH
77-1005	3 Sharp Prongs	22 mm



Cobra Retractor

CODE	DESCRIPTION	LENGTH
37-4105	Sharp, 1 ¼ in Tip	9 ¾ in 250 mm
37-4106	Blunt, 1 ¼ in Tip	9 ¾ in 250 mm



Collin Retractor

CODE	DESCRIPTION	LENGTH
22-1215	Double-Ended	6 in 152 mm

Retractors

Darrach Retractor



77-1008

CODE	JAW	TOTAL LENGTH
77-6005	9 mm	10¼ in 260 mm
77-6002	13 mm	10¼ in 260 mm
77-6003	19 mm	10¼ in 260 mm
77-6004	25 mm	10¼ in 260 mm

Fukuda Shoulder Retractor



77-1006

CODE	BLADE	LENGTH
77-1007	1¼ x 3⅜ in 32 x 81 mm	7 in 175 mm
77-1006	1½ x 3⅜ in 38 x 81 mm	7 in 175 mm



Tip



24-0911

Heiss Retractor

CODE	DESCRIPTION	PRONGS	LENGTH
24-0911	Sharp	4 x 4	4 in 100 mm
24-0912	Blunt	4 x 4	4 in 100 mm

Hohman Retractor



77-1189

CODE	DESCRIPTION	BLADE	LENGTH
77-1188	Curved 120°	22 mm	16 in 405 mm
77-1189	Curved 90°	40 mm	13 in 355 mm

Retractors

Hohman Retractor



CODE	DESCRIPTION	DIMENSIONS
77-1120	Finger Holes and Finger Ring	4 ¾ in 120 mm

Hohman Retractor



CODE	WIDTH	LENGTH
77-1122	15 mm	6 in 150 mm

Horizontal Retractor



CODE	DESCRIPTION	PRONGS	LENGTH
24-3500	Sharp	4 x 2 mm	12 in 305 mm

Israel Retractor



22-7204

CODE	DESCRIPTION	PRONGS	LENGTH
22-7204	Blunt	4	10 in 250 mm
22-7205	Blunt	5	10 in 250 mm
22-7206	Blunt	6	10 in 250 mm

Retractors



Kelly Retractor

23-4701

CODE	DESCRIPTION	BLADE	LENGTH
23-4701	Standard Handle	1½ x 2 in 38 x 50 mm	10¼ in 260 mm
23-4702	Standard Handle	2 x 2½ in 50 x 63 mm	10¼ in 260 mm
23-4703	Standard Handle	2½ x 3 in 63 x 76 mm	10¼ in 260 mm
23-4703	Standard Handle	3 x 3½ in 76 x 89 mm	10¼ in 260 mm

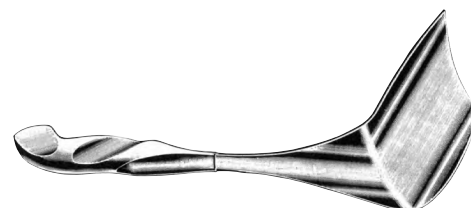

Kelly Retractor

23-4711

CODE	DESCRIPTION	BLADE	LENGTH
23-4711	Lamb	1¼ x 2 in 32 x 50 mm	10¼ in 260 mm
23-4712	Lamb	2 x 2½ in 50 x 63 mm	10¼ in 260 mm
23-4713	Lamb	2½ x 3 in 63 x 76 mm	10¼ in 260 mm
23-4714	Lamb	3 x 3½ in 76 x 89 mm	10¼ in 260 mm

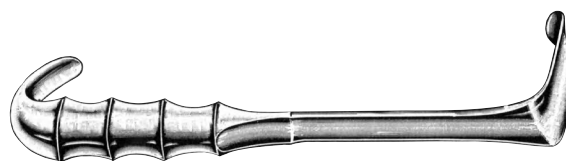

Kelly Retractor

23-4715

CODE	DESCRIPTION	BLADE	LENGTH
23-4715	Grip Handle	1½ x 2 in 38 x 50 mm	10¼ in 260 mm
23-4716	Grip Handle	2 x 2½ in 50 x 63 mm	10¼ in 260 mm
23-4717	Grip Handle	2½ x 3 in 63 x 76 mm	10¼ in 260 mm
23-4718	Grip Handle	3 x 3½ in 76 x 89 mm	10¼ in 260 mm

Kolbel Retractor

CODE	DESCRIPTION	LENGTH
24-4175	2 x 2 in Prong	7 in 177 mm

Retractors



Lahey Retractor

CODE	DESCRIPTION	LENGTH
23-0306	Retractor	7¾ in 195 mm



Langenbeck Retractor

23-0710

CODE	BLADE	LENGTH
23-0710	¾ x 1½ in 10 x 38 mm	8¾ in 220 mm



Markham-Meyerding Retractor

24-4591

CODE	DESCRIPTION	PRONGS	LENGTH
24-4591	Left	25 x 30 mm	7⅞ in 180 mm
24-4590	Right	25 x 30 mm	7⅞ in 180 mm



Mcelroy Angulated Retractor

77-1191

CODE	DESCRIPTION	LENGTH
77-1191	T-Handle Retractor	10¾ in 270 mm



Murphy Retractor

22-5004

CODE	DESCRIPTION	PRONGS	DIMENSIONS
22-5004	Sharp	4	7¾ in 195 mm
22-5006	Sharp	6	7¾ in 195 mm
22-5103	Blunt	3	7¾ in 195 mm
22-5104	Blunt	4	7¾ in 195 mm

Retractors



20-1002

Meyering Finger Retractor

CODE	DESCRIPTION	LENGTH
20-1001	#1	7 1/8 in 180 mm
20-1002	#2	7 1/8 in 180 mm

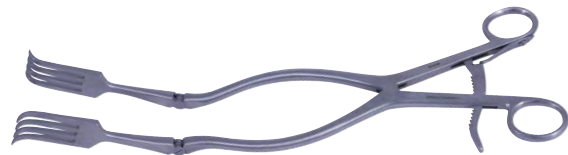

Oberhill Retractor

CODE	DESCRIPTION	BLADES	LENGTH
24-3449	Four-Prongs, Hinged Blades	1 x 1 1/4 in	13 in 355 mm



Ollier Retractor

CODE	DESCRIPTION	PRONGS	LENGTH
22-7002	Blunt	4	8 1/2 in 215 mm



22-1418

Parker Retractor

Double-Ended

CODE	DESCRIPTION	LENGTH
22-1413	Set of 2	5 in 125 mm
22-1418	Set of 2	7 in 175 mm

Retractors

Pelvic Retractor



CODE	DESCRIPTION	LENGTH
77-1014	24 mm Wide Blade	10 3/4 in 270 mm



23-4501

Richardson Retractor

CODE	DESCRIPTION	BLADE	LENGTH
23-4501	Standard	3/4 x 1 in 19 x 25 mm	9 1/2 in 240 mm
23-4502	Standard	1 x 1 1/4 in 25 x 32 mm	9 1/2 in 240 mm
23-4503	Standard	1 1/2 x 1 1/2 in 38 x 38 mm	9 1/2 in 240 mm
23-4504	Standard	3/4 x 2 in 19 x 50 mm	9 1/2 in 240 mm
23-4505	Standard	1 5/8 x 2 1/2 in 41 x 57 mm	9 1/2 in 240 mm



23-4514

Richardson Retractor

CODE	DESCRIPTION	BLADE	LENGTH
23-4511	Lamb	3/4 x 1 in 19 x 25 mm	10 1/2 in 260 mm
23-4512	Lamb	1 x 1 1/4 in 25 x 32 mm	10 1/2 in 260 mm
23-4513	Lamb	1 1/2 x 1 1/2 in 38 x 38 mm	10 1/2 in 260 mm
23-4514	Lamb	3/4 x 2 in 19 x 50 mm	10 1/2 in 260 mm

Richardson Retractor

CODE	DESCRIPTION	BLADE	LENGTH
23-4515	Grip Handle	3/4 x 1 in 19 x 25 mm	9 1/2 in 240 mm
23-4516	Grip Handle	1 x 1 1/4 in 25 x 32 mm	9 1/2 in 240 mm
23-4517	Grip Handle	1 1/2 x 1 1/2 in 38 x 38 mm	9 1/2 in 240 mm
23-4518	Grip Handle	3/4 x 2 in 19 x 50 mm	9 1/2 in 240 mm
23-4520	Grip Handle	1 1/4 x 4 in 32 x 100 mm	9 1/2 in 240 mm

Retractors

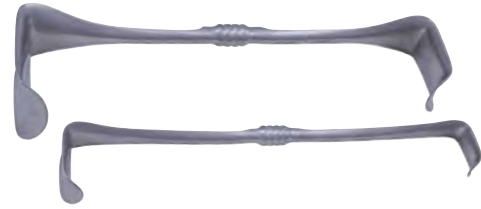

23-4550

Richardson-Eastman Retractor

Double-Ended

CODE	DESCRIPTION	LENGTH
23-4550	Set of Two	11 in 279 mm
23-4551	Small Only	11 in 279 mm
23-4552	Large Only	11 in 279 mm



22-1616

Roux Retractor

CODE	DESCRIPTION	DIMENSIONS
22-1614	Small	$\frac{7}{8} \times 1\frac{1}{8} \times 6\frac{3}{4}$ in 22 x 29 x 171 mm
22-1615	Medium	$1 \times 1\frac{1}{2} \times 6\frac{3}{4}$ in 25 x 38 x 171 mm
22-1616	Large	$1\frac{1}{4} \times 1\frac{3}{4} \times 6\frac{3}{4}$ in 32 x 44 x 171 mm



23-1501

Sauerbruch Retractor

CODE	DESCRIPTION	BLADE DIMENSIONS	LENGTH
23-1501	#1	$\frac{3}{4} \times 1\frac{3}{4}$ in 19 x 44 mm	9 in 230 mm
23-1502	#2	$1\frac{5}{16} \times 2\frac{1}{8}$ in 24 x 54 mm	9 in 230 mm
23-1503	#3	$1\frac{3}{16} \times 2\frac{7}{8}$ in 21 x 73 mm	9 in 230 mm



20-0508

Senn Retractor

CODE	DESCRIPTION	LENGTH
20-0508	Double-Ended, Sharp	$6\frac{1}{4}$ in 160 mm
20-0509	Double-Ended, Blunt	$6\frac{1}{4}$ in 160 mm

Retractors



22-1553

Sofield Retractor

CODE	DESCRIPTION	BLADES
22-1551	Double-Ended	63 x 13 mm and 38 x 13 mm
22-1552	Double-Ended	70 x 13 mm and 44 x 13 mm
22-1553	Double-Ended	83 x 16 mm and 51 x 16 mm
22-1554	Double-Ended	89 x 16 mm and 57 x 16 mm
22-1555	Double-Ended	102 x 19 mm and 70 x 19 mm
22-1556	Double-Ended	114 x 19 mm and 76 x 19 mm

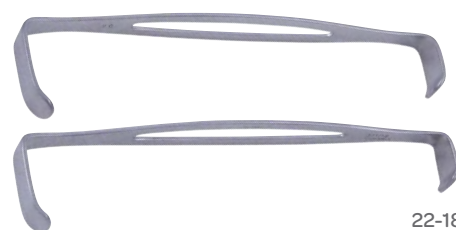

22-1821

US Army Retractor

CODE	DESCRIPTION	LENGTH
22-1821	Retractor Set of 2	8¼ in 210 mm



Volkmann Retractor

CODE	DESCRIPTION	PRONGS	LENGTH
22-5806	Sharp	6	9½ in 240 mm

Retractors



22-2603

Volkmann Retractor

CODE	DESCRIPTION	PRONGS	LENGTH
22-2602	Sharp	2	4 ½ in 115 mm
22-2603	Sharp	3	4 ½ in 115 mm
22-2604	Sharp	4	4 ½ in 115 mm
22-2606	Sharp	6	4 ½ in 115 mm
22-2703	Blunt	3	4 ½ in 115 mm
22-2704	Blunt	4	4 ½ in 115 mm
22-2706	Blunt	6	4 ½ in 115 mm



22-3402

Volkmann Retractor

CODE	DESCRIPTION	PRONGS	LENGTH
22-3402	Sharp	2	8 ¾ in 220 mm
22-3403	Sharp	3	8 ¾ in 220 mm
22-3404	Sharp	4	8 ¾ in 220 mm
22-3406	Sharp	6	8 ¾ in 220 mm
22-3502	Blunt	2	8 ¾ in 220 mm
22-3503	Blunt	3	8 ¾ in 220 mm
22-3504	Blunt	4	8 ¾ in 220 mm

Retractors (Glenoid)



Hinterman Retractor

CODE	DESCRIPTION	LENGTH
78-5599	With K-Wire Guide	7 in 175 mm

Retractors (Hand)



20-1776

Hayes Hand Retractor

CODE	DESCRIPTION	LENGTH
20-1776	Hand Retractor	6 ¼ in 160 mm
20-1777	Hand Retractor	6 ¼ in 160 mm

Retractors (Hip)



13-023-000

Minimally Invasive Hip Retractor

CODE	SIZE	DESCRIPTION	DIMENSIONS
13-023-000	#1, Curved	25 mm Blade Pointed Tip	9 x 5/32 x 5/8 in 229 x 4 x 16 mm
13-024-000	#2, Curved	Blunt Tip	9 x 1/8 x 1/2 in 229 x 3 x 13 mm
13-025-000	#3, Offset		9 x 3/32 x 3/8 in 229 x 2 x 10 mm
13-026-000	#4	Long Hohmann	9 x 1/16 x 1/4 in 229 x 1.6 x 6.3 mm
13-027-000	#5	Long Hohmann, Short Curved Blade	10 in 254 mm
13-029-000	#7	Long Hohmann, Narrow Blade	
13-030-000	#8	Small Hohmann	

Retractors (Knee)



Blount (Bird Beak) Knee Retractor

CODE	DESCRIPTION	TIP	LENGTH
77-5650	Knee Retractor	9 mm, Distal	7 in 175 mm

Retractors (Knee)



78-5998

Doane (Z) Knee Retractor

Double-Ended

CODE	DESCRIPTION	BLADE	WIDTH	LENGTH
78-5999	Medium	152 x 63 mm	152 x 76 mm	11 mm 7 in 175 mm
78-5998	Large	152 x 57 mm	152 x 69 mm	11 mm 7 in 175 mm



13-035-000

Minimally Invasive Knee Retractor

CODE	SIZE	DESCRIPTION	LENGTH
13-035-000	#1	Small Hohmann	
13-036-000	#2	Large Hohmann	
13-037-000	#3	Condylar Retractor	
13-038-000	#4	Superior Retractor	
13-039-000	#5	Patellar Retractor	7 in 175 mm
13-040-000	#6	Collateral Retractor, Left	7 in 175 mm
13-041-000	#7	Collateral Retractor, Right	4 3/4 in 120 mm
13-042-000	#8	Soft Tissue Retractor	11 mm



77-5601

Smillie Knee Retractor

CODE	DESCRIPTION	BLADE	LENGTH
77-5601	Knee Retractor	3/4 x 1 1/4 in	5 1/2 in 140 mm
77-5602	Knee Retractor	3/4 x 1 3/4 in	5 1/2 in 140 mm
77-5603	Knee Retractor	3/4 x 2 3/8 in	5 1/2 in 140 mm

Retractors (Knee)

Smillie Knee Retractor

CODE	DESCRIPTION	BLADE	LENGTH
77-5610	Knee Retractor	½ x ¾ in 13 x 18 mm	5 ½ in 140 mm
77-5611	Knee Retractor	½ x 1 in 13 x 25 mm	5 ½ in 140 mm



Smillie Knee Retractor

CODE	DESCRIPTION	BLADE	LENGTH
77-5621	Double-Curved	½ x 2 ⅞ in 13 x 55 mm	5 ½ in 140 mm

Retractors (Mini)

Hohman Mini Retractor

CODE	DESCRIPTION	LENGTH
77-1050	Mini	6 ¼ in 160 mm
77-1052	Mini	6 ¼ in 160 mm



77-1050

Retractors (PCL)

Worland PCL Retractor

CODE	TIP	LENGTH
13-001-000	13 mm	12 ½ in 320 mm



Retractors (Self-Retaining)

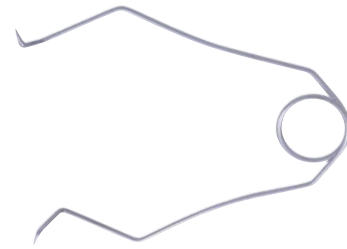

24-0307

Farr Spring Retractor

CODE	DESCRIPTION	PRONGS	LENGTH
24-0306	Spring Retractor	1 in 25 mm	9 in 230 mm
24-0307	Spring Retractor	1 in 25 mm	5½ in 140 mm

Spring Retractor

CODE	DESCRIPTION	PRONGS	LENGTH
24-0352	Spring Retractor	1x1	4¼ in 105 mm

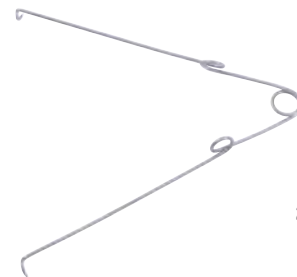

24-0302

Spring Retractor

CODE	DESCRIPTION	PRONGS	LENGTH
24-0301	Spring Retractor	1x1	3½ in 90 mm
24-0302	Spring Retractor	1x1	4½ in 115 mm

Spring Retractor

CODE	DESCRIPTION	PRONGS	LENGTH
24-0303	Spring Retractor	3x3	3½ in 90 mm
24-0304	Spring Retractor	3x3	4½ in 115 mm

Retractors (Self-Retaining)



24-2210

Weitlaner Retractor

CODE	DESCRIPTION	PRONGS	LENGTH
24-2210	Sharp	2 x 3	4 ½ in 115 mm
24-2213	Sharp	3 x 4	5 ½ in 140 mm
24-2216	Sharp	3 x 4	6 ½ in 165 mm
24-2220	Sharp	3 x 4	8 in 200 mm
24-2224	Sharp	3 x 4	9 in 230 mm
24-2211	Blunt	3 x 4	4 ½ in 115 mm
24-2214	Blunt	3 x 4	5 ½ in 140 mm
24-2217	Blunt	3 x 4	6 ½ in 165 mm
24-2221	Blunt	3 x 4	8 in 200 mm
24-2225	Blunt	3 x 4	9 in 228 mm



24-3014

Weitlaner-Beckmann Retractor

Hinged Arms

CODE	DESCRIPTION	PRONGS	LENGTH
24-3014	Blunt	3 x 4	5 ½ in 140 mm
24-3017	Blunt	3 x 4	6 ½ in 165 mm
24-3021	Blunt	3 x 4	8 ½ in 215 mm
24-3024	Blunt	3 x 4	9 ½ in 240 mm
24-3023	Sharp	3 x 4	9 ½ in 240 mm



24-4760

Wiltse-Gelpi Retractor

CODE	DESCRIPTION	LENGTH
24-4760	Deep Sharp Blades, Sharp Prongs	11 in 280 mm
24-4760-L	Deep Sharp Blades, Sharp Prongs, Extra Long	14 in 355 mm

Retractors (Soft Tissue)

Kolbel Soft Tissue Retractor

Set of Two

CODE	BLADE	BLADE
24-4617	Small Blade	36 x 36 mm
24-4618	Large Blade	53 x 36 mm
24-4174	Blade	20 x 53 mm

Rongeurs (Arthroscopic)

Rongeur

CODE	DESCRIPTION	BITE WIDTH
1010401	Straight Tip	3 mm
1010402	Straight Tip, Curved up 15°	3 mm
1040401	Straight	4 mm



Rongeurs (Bone)

Bane Bone Rongeur

CODE	DESCRIPTION	JAWS	LENGTH
30-3818	Curved	5 mm	7 1/8 in 180 mm



Rongeurs (Bone)

Beyer Rongeur

CODE	DESCRIPTION	JAWS	LENGTH
31-1103	Curved	3 mm	7 in 175 mm
31-1104	Curved	4 mm	7 in 175 mm

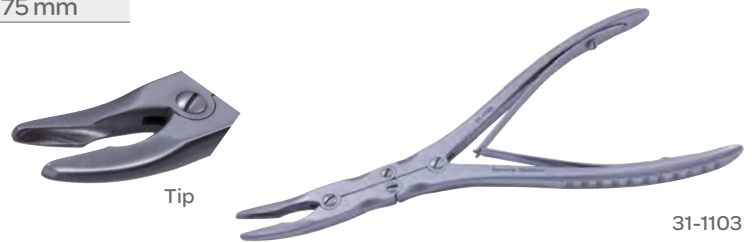

Beyer Rongeur

CODE	DESCRIPTION	LENGTH
53-1100	Curved, Double Action	7 in 178 mm



Blumenthal Rongeur

CODE	DESCRIPTION	JAWS	LENGTH
30-2547	Angled 30°	4 mm	6 ¼ in 160 mm
30-2545	Angled 45°	4 mm	6 ¼ in 160 mm
30-2546	Angled 90°	4 mm	6 ¼ in 160 mm

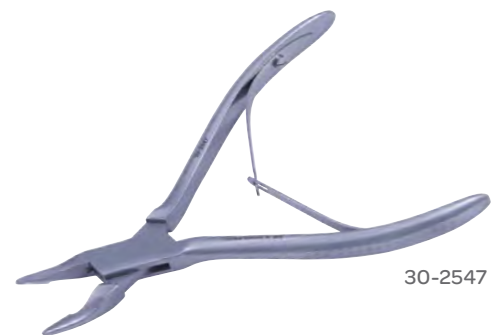

Rongeurs (Bone)

Cottle-Jansen Rongeur

CODE	DESCRIPTION	LENGTH
30-5312	Angled Jaws, 12 x 5 mm	6 ³ / ₄ in 170 mm

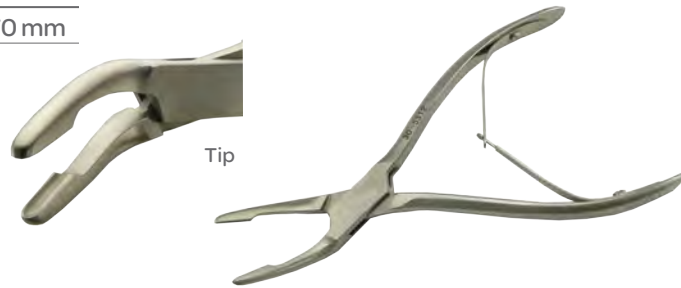

Cushing Rongeur

CODE	DESCRIPTION	JAWS	LENGTH
30-3185	Straight	6 mm	8 in 200 mm
30-3184	Curved	6 mm	8 in 200 mm

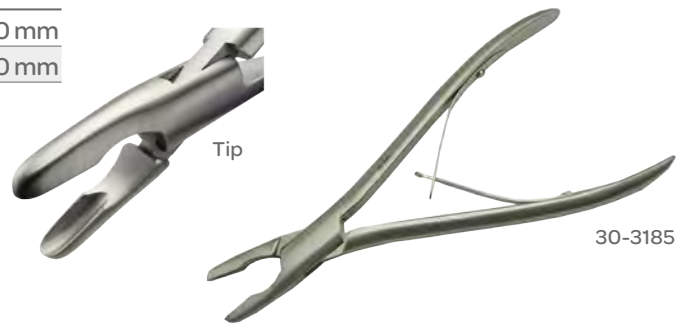

Dawson-Yuhl-Leksell Rongeur

CODE	DESCRIPTION	LENGTH
31-0931	5 x 13 mm Jaw	11 ¹ / ₂ in 290 mm

De Vilbiss Rongeur

CODE	DESCRIPTION	LENGTH
53-1030	With One Extra Blade	8 ¹ / ₁₆ in 205 mm



Rongeurs (Bone)

Echlin Duckbill Rongeur

CODE	DESCRIPTION	JAWS	LENGTH
31-6102	Angled	2x10 mm	9 in 230 mm

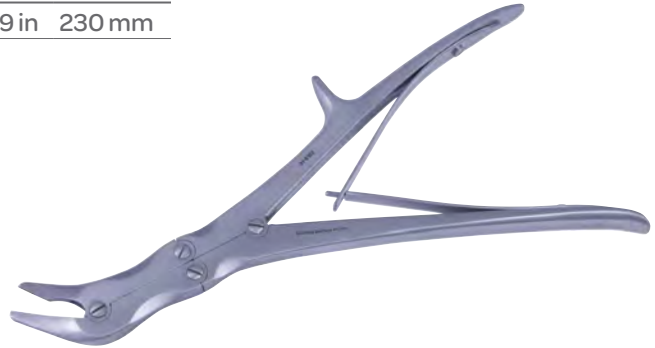

Friedman Bone Rongeur

Curved

CODE	DESCRIPTION	JAWS	LENGTH
30-0514	Delicate	4.0 mm Wide	5 ½ in 140 mm
30-0516	Curved	4 x 11 mm Bite	5 ½ in 140 mm



30-0514

Friedman Micro Rongeur

CODE	DESCRIPTION	JAWS	LENGTH
30-0201	Straight, Very Delicate	1.5 mm	5 ½ in 140 mm
30-0203	Straight, Delicate	2 mm	6 in 150 mm
30-0202	Curved, Very Delicate	1.5 mm	5 ½ in 140 mm
30-0204	Curved, Delicate	2 mm	6 in 150 mm



30-0202

Rongeurs (Bone)

Fulton Rongeur

CODE	DESCRIPTION	JAWS	LENGTH
31-0811	Curved	7 mm	9½ in 240 mm



Leksell Rongeur

CODE	DESCRIPTION	JAWS	LENGTH
31-5103	Slight Curved Handles	3 mm	9 in 230 mm
31-5105	Slight Curved Handles	5 mm	9 in 230 mm
31-5108	Slight Curved Handles	8 mm	9 in 230 mm



31-5105

Leksell Rongeur

CODE	DESCRIPTION	JAWS	LENGTH
31-5303	Full Curved Handles	3 mm	9 in 230 mm

Rongeurs (Bone)

Lempert Rongeur

CODE	DESCRIPTION	BITE	LENGTH
53-1108	Straight	1/16 in 2 mm	6 1/8 in 156 mm
53-1102	Curved	1/16 in 2 mm	6 1/8 in 156 mm



53-1102

Lempert Rongeur

Slender Pattern

CODE	DESCRIPTION	JAWS	LENGTH
30-7620	Straight	2.5 mm	6 1/4 in 160 mm
30-7623	Straight	2.5 mm	7 1/2 in 190 mm
30-7622	Curved	2.5 mm	6 1/4 in 160 mm
30-7624	Curved	2.5 mm	7 1/2 in 190 mm
30-7625	Curved	2.5 mm	7 1/2 in 190 mm

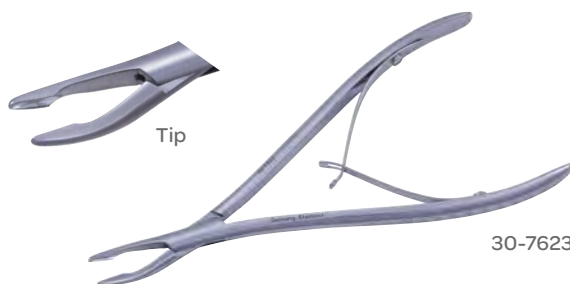

30-7623

Luer Bone Rongeur

CODE	DESCRIPTION	WIDTH	LENGTH
30-5217	Straight	8 mm	7 1/8 in 180 mm



Rongeurs (Bone)

Luer Bone Rongeur

CODE	DESCRIPTION	BITE	LENGTH
53-1010	Straight	1/16 in 2 mm	7 in 178 mm
53-1011	Curved	1/16 in 2 mm	7 in 178 mm



53-1010

Olivecrona Rongeur

CODE	DESCRIPTION	LENGTH
31-0401	Curved Light	7 3/4 in 196 mm



Tip

Reiner Bone Rongeur

CODE	DESCRIPTION	LENGTH
53-1015	Curved, Bite 3 x 13 mm	7 in 178 mm
53-1016	Curved, Bite 4 x 14 mm	7 in 178 mm



53-1015

Rongeurs (Bone)

Reiner Rongeur

CODE	DESCRIPTION	LENGTH
30-7627	4 mm Bite	7 in 178 mm

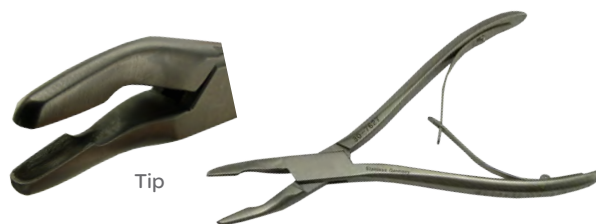

Rongeur

CODE	DESCRIPTION
15-003-000	Cement, Serrated Teeth, 300 mm

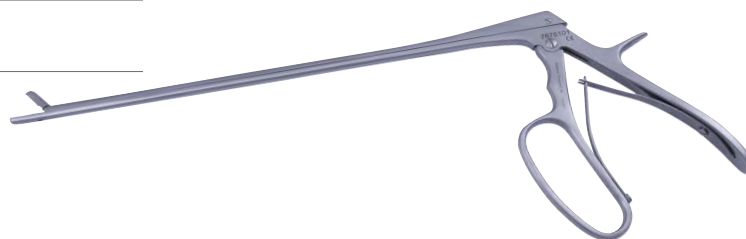

Ruskin Bone Rongeur

CODE	DESCRIPTION	JAWS	LENGTH
31-0605	Straight	5 mm	7 1/8 in 180 mm
31-0625	Straight	5 mm	9 1/2 in 240 mm
31-0705	Curved	5 mm	7 1/8 in 180 mm
31-0725	Curved	6 mm	7 1/4 in 184 mm
31-0706	Curved	5 mm	9 1/2 in 240 mm

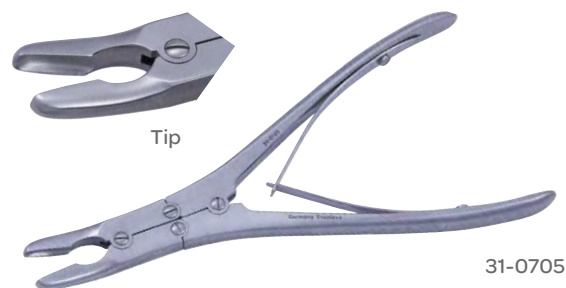

Ruskin Duckbill Rongeur

CODE	DESCRIPTION	JAWS	LENGTH
31-0765	Curved to Side	5 mm	7 1/8 in 180 mm



Rongeurs (Bone)

Ruskin Rongeur

Double-Action

CODE	DESCRIPTION	LENGTH
53-1310	Straight, 4 x 33 mm Bite	7¼ in 185 mm
53-1312	Straight, 5 x 33 mm Bite	7¼ in 185 mm
53-1311	Curved, 4 x 33 mm Bite	7¼ in 185 mm
53-1313	Curved, 5 x 33 mm Bite	7¼ in 185 mm



53-1310

Ruskin Rongeur

CODE	DESCRIPTION	LENGTH
31-0504	Curved, 4 mm	6 in 150 mm

Sauerbruch-Stille Bone Rongeur

Double-Action

CODE	DESCRIPTION	JAWS	LENGTH
31-3097	Straight, Square Jaws	20 mm Wide	11 in 280 mm
31-3096	Curved, Round Jaws	20 mm Wide	11 in 280 mm



31-3096

Semb Stille Rongeur

CODE	DESCRIPTION	LENGTH
31-3153	Curved	9 in 230 mm



Rongeurs (Bone)

Smith-Peterson Rongeur

CODE	DESCRIPTION	LENGTH
31-0913	Slight Curve	9½ in 240 mm



Stille-Luer Bone Rongeur

CODE	DESCRIPTION	JAWS	LENGTH
31-3023	Straight	10 mm	9 in 230 mm
31-3123	Curved	10 mm	9 in 230 mm
31-3121	Curved	10 mm	10½ in 265 mm



Stille-Luer Bone Rongeur

CODE	DESCRIPTION	JAWS	LENGTH
31-3027	Straight	17 mm	10½ in 265 mm



Stille-Luer Duckbill Bone Rongeur

CODE	DESCRIPTION	JAWS	LENGTH
31-3183	Angled	7 mm	9 in 230 mm



Rongeurs (Bone)

Stille-Luer Echlin Rongeur

CODE	DESCRIPTION	JAWS	LENGTH
31-3193	Angled	5 mm	9 in 230 mm

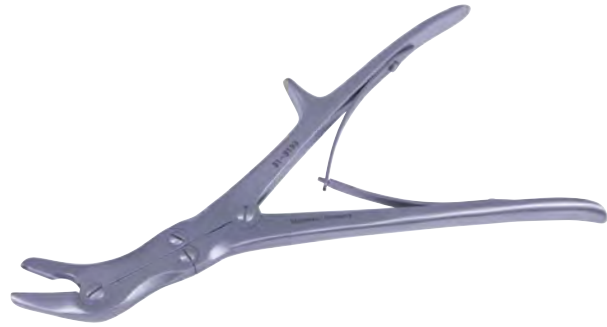

Stille-Luer Rongeur

CODE	DESCRIPTION	LENGTH
53-1130	10 mm, Angular, Straight, Flat on Jaw	8½ in 216 mm
53-1131	Curved, 10 mm, Bite	8½ in 216 mm
53-1118	Angular, 5 mm, Flat Lower Jaw	9½ in 241 mm
53-1133	Straight, 5 mm, Angular	9½ in 241 mm



53-1130

Zaufal-Jansen Rongeur

CODE	DESCRIPTION	JAWS	LENGTH
31-1105	Double-Action	5x15 mm	7 in 175 mm

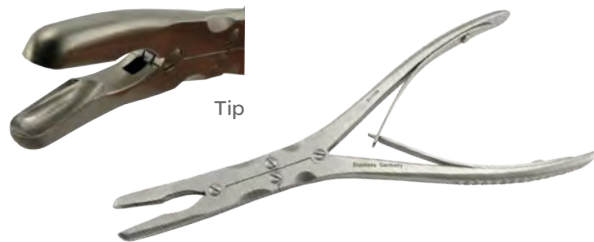

Tip

Zaufal-Jansen Rongeur

Bite 4 x 30 mm

CODE	DESCRIPTION	BITE	LENGTH
53-1095	Curved, Double-Action	4 x 30 mm	6¾ in 170 mm



Rongeurs (Cement Removal)

Rongeur

CODE	DESCRIPTION	LENGTH
15-002-000	Cement	10 in 250 mm



Rongeurs (Mini)

Ruskin Mini Rongeur

CODE	DESCRIPTION	JAWS	LENGTH
31-0402	Straight	2 mm	6 in 150 mm
31-0403	Straight	3 mm	6 in 150 mm
31-0502	Curved	2 mm	6 in 150 mm
31-0503	Curved	3 mm	6 in 150 mm



Rongeurs (Synovectomy)

Kleinert-Kutz Synovectomy Rongeur

CODE	DESCRIPTION	JAWS	LENGTH
30-7613	Slightly Curved	2 mm	5½ in 140 mm
30-7614	Fully Curved	2 mm	5½ in 140 mm

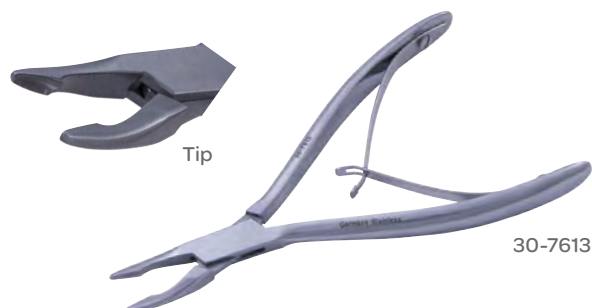

Rongeurs (Synovectomy)

Kleinert-Kutz Synovectomy Rongeur

CODE	DESCRIPTION	JAWS	LENGTH
31-0552	Slight Curved	2 x 13 mm	6 in 150 mm
31-0553	Slight Curved	3 x 16 mm	6 in 150 mm



31-0552

Scissors (Arthroscopic)

Scissors

CODE	DESCRIPTION
1010202	20° Tip, Hooked Left, Loop
1000442	20° Tip, Hooked Left Loop
1010210	60° Tip, Hooked Left, Loop
1010204	20° Tip, Hooked Right, Loop
1000443	20° Tip, Hooked Right Loop
1010212	60° Tip, Hooked Right, Loop
1010208	20° Tip, Short Serrated Left, Loop
1010209	20° Tip, Short Serrated Right, Loop



1010202

Scissors (Cartilage)

Martin Cartilage Scissors

CODE	DESCRIPTION	LENGTH
77-5520	Two Serrated Blades	8 in 200 mm



Shuttles (Arthroscopic)

Suture Shuttle

CODE	DESCRIPTION
1020701	Straight
1000641	Straight
1000684	Straight
1020702	45° Left
1000642	45° Left
1000685	45° Left
1020703	45° Right
1000643	45° Right
1000686	45° Right
1000644	35° Up
1000687	35° Up
1020704	35° Up



Skids (Bone)

Murphy-Lane Bone Skid Retractor

CODE	LENGTH
77-1193	12in 305 mm



Skids (Hip & Shoulder)

Meyerding Hip & Shoulder Skid

CODE	LENGTH
77-1190	13in 330 mm

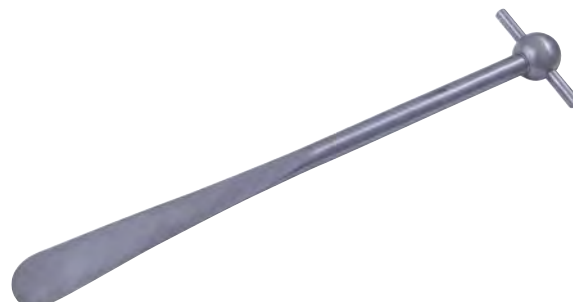

Skids (Lever)

Skid Lever Retractor

CODE	DESCRIPTION	LENGTH
77-4190	Double-Ended	6¼in 160 mm



Splitters (Cement)

Acetabular Cement Splitter

CODE	DESCRIPTION
10-011-000	Round



Flag Splitter

CODE
10-001-000



"V" Splitter

CODE
10-002-000



Tamps (Bone)

Bone Chip Tamp

CODE	DESCRIPTION	HEAD	LENGTH
27-9415	Round Head	6.3 mm	9½ in 241 mm
27-9411	Rectangular Head	2 x 9 mm	10 in 251 mm
27-9412	Rectangular Head	6 x 9 mm	10 in 251 mm
27-9413	Rectangular Head	3 x 16 mm	10 in 251 mm



27-9415

Bone Tamp

CODE	DESCRIPTION	LENGTH
27-9502	2 mm	6 in 152 mm
27-9503	3 mm	6 in 152 mm
27-9504	4 mm	6 in 152 mm
27-9505	5 mm	6 in 152 mm
27-9506	6 mm	6 in 152 mm
27-9507	7 mm	6 in 152 mm
27-9508	8 mm	6 in 152 mm
27-9520	20 mm	8 in 203 mm



27-9502

Caspar Bone Tamp

CODE	DESCRIPTION	LENGTH
27-9516	5 mm	8 in 203 mm



Sypert Tamp

CODE	DESCRIPTION	LENGTH
27-9534	4 x 10 mm	11½ in 292 mm
27-9535	5 x 15 mm	11½ in 292 mm
27-9536	6 x 20 mm	11½ in 292 mm



27-9534

Taps

Tap

CODE	DESCRIPTION
11-101-000	4.5 mm
11-102-000	6.5 mm



11-101-000

Wire & Traction (Pliers)

Pliers/Cutter

CODE	DESCRIPTION	LENGTH
14-5065	3.5 Tip, Flat Nose	6½ in 165 mm



Wire Extraction Pliers

CODE	DESCRIPTION	LENGTH
32-113	Fine Tungsten Carbide Jaws, 6 mm Jaw	7 in 175 mm



Wire & Traction (Pliers/Cutter)

Wire Cutting Pliers

CODE	DESCRIPTION	LENGTH
76-4573	Fine Tungsten Carbide	9 in 230 mm



Wire & Traction (Tightener)

Loute Wire Tightener

CODE	LENGTH
76-0550	8½ in 215 mm



Wire & Traction (Traction Bow)

Boelher Wire & Pin Traction Bow

CODE	DESCRIPTION	DIMENSIONS
76-4401	Small	90 x 75 mm
76-4402	Medium	106 x 90 mm
76-4403	Large	210 x 150 mm

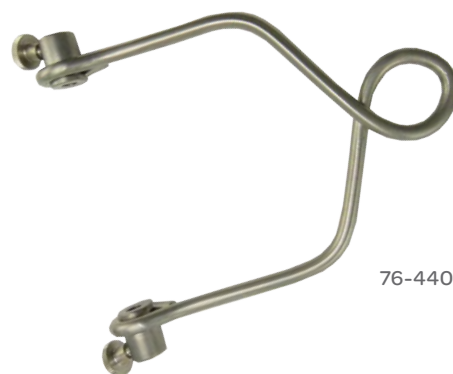

76-4401

Kirschner Bow

CODE	DESCRIPTION	LENGTH
76-4001	Medium	5¾ in 145 mm
76-4002	Large	7½ in 190 mm
76-4003	Extra Large	9½ in 240 mm

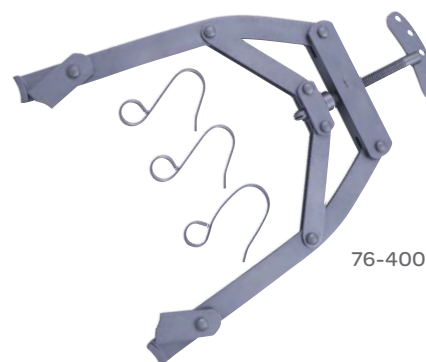

76-4003

Wire & Traction (Twister)

Rubio Wire Twister

Fine Tungsten Carbide Inserts

CODE	DESCRIPTION	LENGTH
32-302	Snub Nose	5¼ in 135 mm



Ultra™ Wire Twister & Sternal Needle Holder

Fine Tungsten Carbide Inserts

CODE	DESCRIPTION	LENGTH
32-122	Blunt Tips	6 in 150 mm
32-123		6¾ in 170 mm



32-122

Wire Twister & Tightener

CODE	LENGTH
14-5635	6¼ in 160 mm



Wire & Traction (Wire Cutter)

Cannulated Pin Cutter

End Cut

CODE	DESCRIPTION	LENGTH
14-3030	Maximum Capacity 0.062 in 1.6 mm	7½ in 190 mm



Double Action Side Cutter

Double Action Side Cut

CODE	DESCRIPTION	LENGTH
32-3371	Straight Jaw	9 in 229 mm
32-3372	Angled Jaw	6½ in 165 mm
32-3373	Angled Jaw	9 in 229 mm



32-3371

Flush Wire Cable Cutter

Fine Tungsten Carbide Jaws

CODE	DESCRIPTION	LENGTH
32-129	Double-Action, Maximum Capacity 1.6 mm	7 in 175 mm





Scan the code above to learn more about our Pediatric portfolio.

Pediatric Portfolio



symmetry surgical™

Pediatric

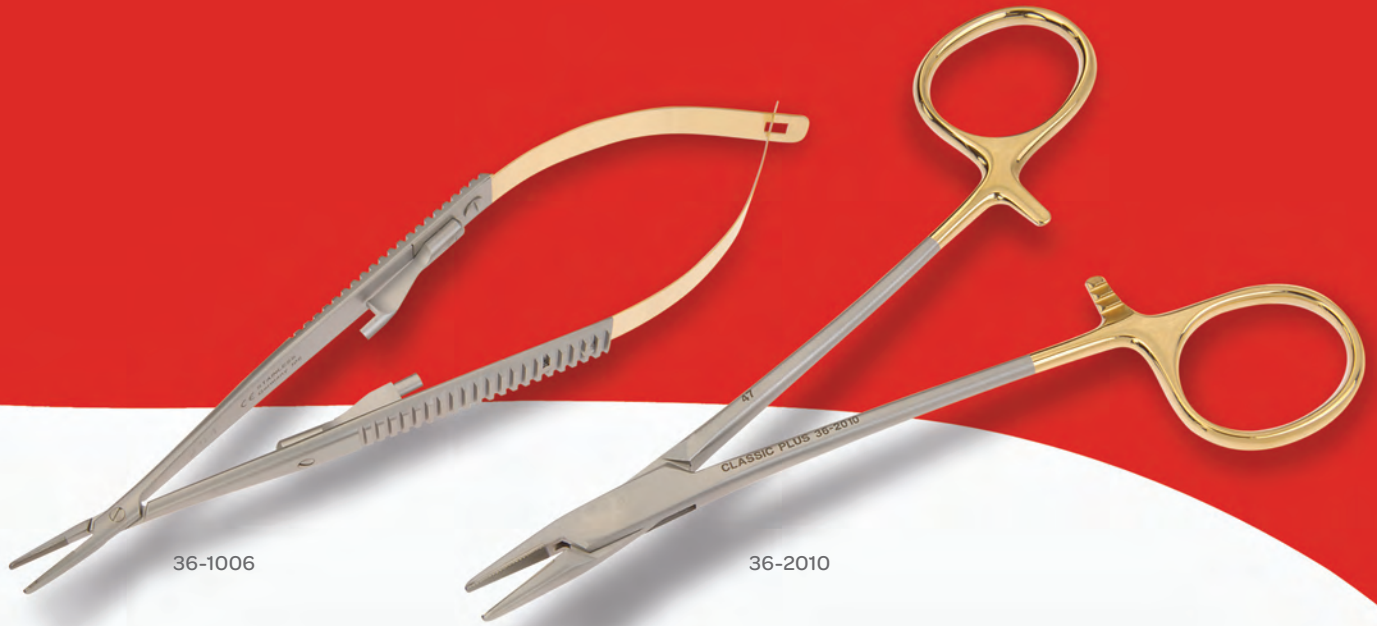

36-1006

36-2010

Approximators, Rib	PED-2	Rasps	PED-22
Clamps	PED-2	Retractors	PED-22
Dilators	PED-6	Rib Spreaders	PED-30
Dual-Purpose	PED-8	Rongeurs	PED-31
Elevators	PED-8	Scissors	PED-33
Forceps	PED-8	Sounds	PED-42
Hooks	PED-17	Speculums	PED-43
Needle Holders	PED-18	Suction Tubes	PED-43
Probes	PED-21	Tissue Forceps	PED-45
Punches	PED-21	Tourniquets	PED-49

Questions? Contact us at customerservice@symmetrysurgical.com or learn more at symmetrysurgical.com

The Surgical Instrument Desk Reference

How to Use Our Catalog

The Symmetry Surgical catalog is designed with you in mind, to be your trusted resource for surgical instrumentation. We took great care in creating an easy-to-use, robust catalog and we think you'll be pleased with the design as you become more familiar with our broad portfolio.

Layout

The catalog is organized by surgical specialty *and* product function.

And we know that it is difficult to pick up an instrument and know what specialty it's listed in. To make your job easier, we've sorted the instruments in our portfolio by surgical function, too, including Energy, Laparoscopic, Retractors and Sterilization Solutions.

U.S. Customer Service

Your Symmetry Surgical Customer Service team wants to make ordering surgical instruments the easiest part of your day. We accept orders via phone, fax, email, our website, Global Healthcare Exchange (GHX) and through the mail.

PHONE

800.251.3000

(Available Monday through Friday, 8:30 AM–6:30 PM EST)

FAX

800.342.3272

EMAIL

customerservice@symmetrysurgical.com

ONLINE

symmetrysurgical.com

MAILING ADDRESS

Symmetry Surgical
Attn: Customer Service
3034 Owen Drive
Antioch, TN 37013

The Surgical Instrument Desk Reference

International Customer Service

PHONE

Symmetry Surgical Switzerland GmbH
+41 (0) 52 557 59 00
(Available Monday through Friday, 7:00-16:00 GMT)

Symmetry Surgical, Inc., USA
615.964.5672
(Available Monday through Friday, 8:30 AM–6:30 PM EST)

FAX

Symmetry Surgical Switzerland GmbH
+41 (0) 52 557 59 99

EMAIL

customerservice@symmetrysurgical.com
internationalorders@symmetrysurgical.com

ONLINE

symmetrysurgical.com

MAILING ADDRESS

Symmetry Surgical Switzerland GmbH
Bühlstrasse 27
CH-8200 Schaffhausen
Switzerland

Symmetry Surgical, Inc.
3034 Owen Drive
Antioch, TN 37013

INTERNATIONAL PAYMENT TERMS/RETURN GOODS POLICY/INSTRUMENT REPAIR & RESTORE PROGRAM/LITERATURE REQUESTS

Please contact your local distributor. Locate a local distributor contact, International Customer Service at +41 (0) 52 557 59 00 or 615.964.5672 (US).

Cardiovascular/Thoracic

Energy

Ear, Nose & Throat

General

Laparoscopic

Neurology

Obesity

OB/GYN

Ophthalmology

Orthopedics & Arthroscopy

Pediatrics

Rectal

Retractors

Spine

Urology

Sterilization Solutions

Alphabetical & Numeric Indexes

Approximators (Rib)

Bailey Pediatric Rib Approximator

CODE	DESCRIPTION	LENGTH
54-2530	Pediatric	5¾ in 146 mm



Clamps (Anastomosis)

Bartley Anastomosis Classic® Clamp

Blades Calibrated at 5.0 mm Intervals

CODE	TEETH	JAW LENGTH	JAW DEPTH	LENGTH
37-1305	2x2 Vascular	1 in 25 mm	½ in 13 mm	5½ in 140 mm



Castaneda Anastomosis Clamp

CODE	DESCRIPTION	JAW LENGTH	JAW DEPTH	LENGTH
30-9003	Small	⅝ in 15 mm	⅕ in 5.0 mm	6 in 153 mm
30-9004	Medium	¾ in 18 mm	¼ in 6.0 mm	6 in 153 mm
30-9005	Large	⅞ in 21 mm	⅓ in 7.0 mm	6 in 153 mm



Clamps (A-V Fistula)

Noon A-V Fistula Clamp

CODE	ANGLE	TEETH	JAW LENGTH	LENGTH
37-1335	50°	1x2 Vascular	1 in 25 mm	4½ in 114 mm



Clamps (Hemostatic)

Gemini Classic® Clamp

CODE	DESCRIPTION	LENGTH
19-5579	Curved, Delicate	5½ in 140 mm



Clamps (Multi-Purpose)

Castaneda Multi-Purpose Clamp

CODE	ANGLE	JAW LENGTH	LENGTH
30-9000	30°	1⅜ in 35 mm	5 in 127 mm
30-9001	50°	1⅜ in 35 mm	5 in 127 mm
30-9006	90°	1⅜ in 35 mm	5 in 127 mm
30-9011	Straight	1⅜ in 35 mm	5 in 127 mm

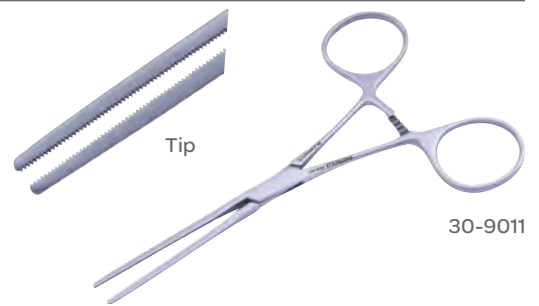

30-9011

Cooley Multi-Purpose Clamp

CODE	ANGLE	JAW LENGTH	LENGTH
37-1291	60°	1⅜ in 30 mm	6 in 153 mm
37-1292	90°	1⅜ in 30 mm	5½ in 140 mm



37-1291

DeBakey Multi Purpose Clamp

CODE	ANGLE	TEETH	JAW LENGTH	LENGTH
37-1321	60°	1x2 Vascular	1⅜ in 35 mm	6 in 153 mm



Clamps (Neonatal Vascular)

Neonatal Vascular Clamp

Curved Shanks, Calibrated Jaws, 1.0 mm wide, Horizontal Serrations

CODE	ANGLE	LENGTH
55-5040	Jaws 30°	5 in 125 mm
55-5042	Jaws 90°	5 in 125 mm



Clamps (Neonatal)

Castaneda Partial Occlusion Clamp

Spoon Type

CODE	JAW LENGTH	JAW DEPTH	LENGTH
30-9002	1 ⁵ / ₁₆ in 33 mm	⁵ / ₁₆ in 8.0 mm	4 ³ / ₄ in 121 mm



Clamps (Pediatric)

Cleveland Clinic Pediatric Clamp

CODE	DESCRIPTION	LENGTH
55-3533	Angled Left, Small Jaw	5 1/2 in 140 mm
55-3534	Angled Right, Small Jaw	5 1/2 in 140 mm



Clamps (Pediatric Ductus)

DeBakey Pediatric Ductus Clamp

CODE	SHANKS	JAWS	LENGTH
55-5053	Straight	Spoon	6 ³ / ₄ in 171 mm
55-5051	Straight	Straight	6 ³ / ₄ in 171 mm
55-5052	Angled	Straight	6 ³ / ₄ in 171 mm

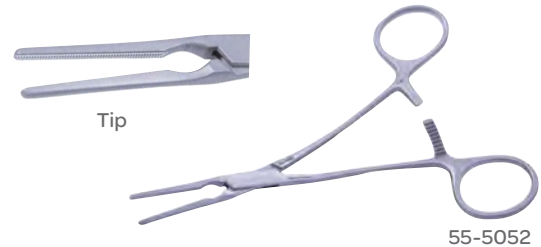

Clamps (Right Angle)

Delicate Classic® Right Angle Clamp

CODE	DESCRIPTION	LENGTH
30-4493	Right Angle Clamp	5 ¹ / ₂ in 140 mm



Clamps (Stay Suture)

Gregory Stay Suture Clamp

Gold Band

CODE	DESCRIPTION	LENGTH
19-8027	Large #2, Smooth Jaws	³ / ₄ in 20 mm
19-8029	Large #4	1 ⁵ / ₈ in 40 mm



Clamps (Thoracic)

Castaneda-Mixer Thoracic Clamp

CODE	DESCRIPTION	LENGTH
19-8150	Smooth Jaws	5 ¹ / ₄ in 133 mm



Clamps (Vascular)

Cooley Pediatric Clamp

CODE	SHANKS	JAWS	LENGTH
55-5002	Straight	Angled	5½ in 140 mm
55-5004	Straight	Spoon	5½ in 140 mm
55-5005	Angled	Straight	5½ in 140 mm



Clamps (Wire Holding)

Rubio Classic® Wire Holder Clamp

Tungsten Carbide

CODE	DESCRIPTION	LENGTH
36-2023	Jaw Inserts	5 in 127 mm

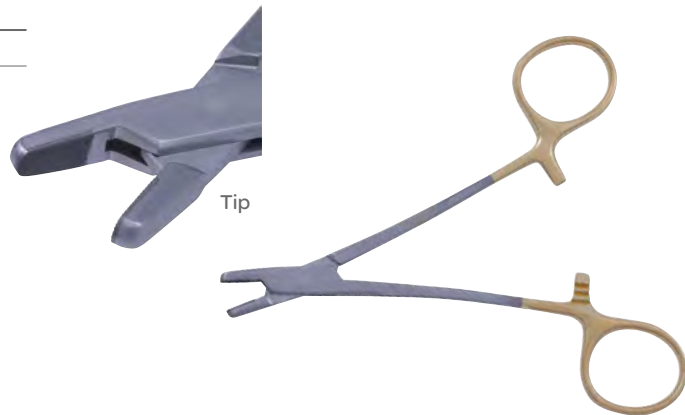

Dilators (Tracheal)

Delaborde Tracheal Dilator

Tri-Valve

CODE	JAW WIDTH	JAW THICKNESS	TOTAL SPREAD	LENGTH
25-4002	⅜ in 5.0 mm	¼ in 6.0 mm	1⅝ in 33 mm	5¼ in 133 mm

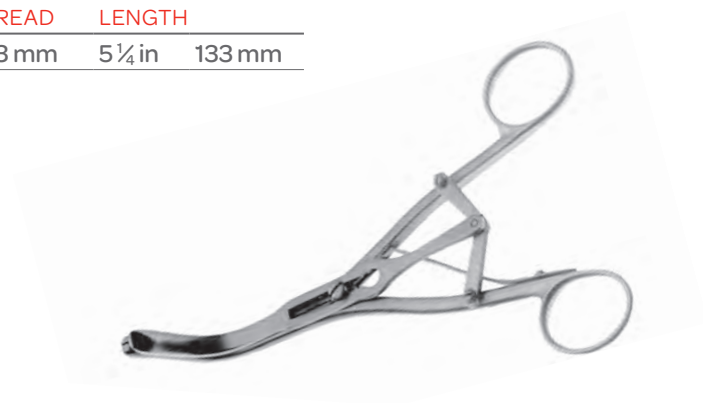

Dilators (Tracheal)

Trousseau Tracheal Dilator

CODE	JAW WIDTH (CLOSED)	JAW THICKNESS	TOTAL SPREAD	LENGTH
25-5569	1/8 in 3.0 mm	1/8 in 3.0 mm	1 1/4 in 32 mm	5 1/4 in 133 mm



Dilators (Vascular)



25-8036



25-8037



25-8039

Garrett Vascular Dilator

CODE	DESCRIPTION	LENGTH
25-8036	1.0 mm, Malleable Shaft	5 1/2 in 140 mm
25-8037	1.5 mm, Malleable Shaft	5 1/2 in 140 mm
25-8038	2.0 mm, Malleable Shaft	5 1/2 in 140 mm
25-8039	2.5 mm, Malleable Shaft	5 1/2 in 140 mm
25-8022	4.0 mm, Malleable Shaft	8 1/2 in 216 mm
25-8024	5.0 mm, Malleable Shaft	8 1/2 in 216 mm

Dual-Purpose (Needle Holders, Forceps & Scissors)

Combination Needle Holder & Forceps

CODE	DESCRIPTION	LENGTH
30-8002	Needle Holder, Forceps	5½ in 140 mm



Olsen-Hegar Classic Plus® Needle Holder & Scissors

Tungsten Carbide

CODE	DESCRIPTION	LENGTH
36-4000	Jaw Inserts	5½ in 140 mm



Elevators (Periosteal)

Carroll Periosteal Elevator

CODE	DESCRIPTION	BLADE WIDTH	BLADE WIDTH	LENGTH
65-2549	Double-Ended	⅛ in 3.0 mm	⅛ in 10 mm	5½ in 140 mm



Forceps (Alligator)

Hoen Alligator Forceps

CODE	DESCRIPTION	TIP WIDTH	TEETH	SHAFT LENGTH
30-1230	Alligator Action	2.2 mm	1x2	5½ in 140 mm



Forceps (Delicate)

Delicate Kocher Classic® Forceps

Delicate, 1 x 2 Teeth

CODE	DESCRIPTION	LENGTH	
30-4490	Straight	5½ in	140 mm
30-4491	Curved	5½ in	140 mm

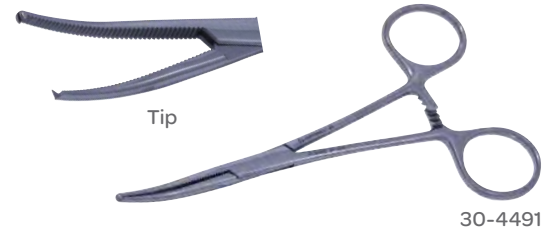

Forceps (Dressing)

Adson Dressings Forceps

CODE	DESCRIPTION	TIP WIDTH	LENGTH	
30-4214	Delicate	0.8 mm	5 in	127 mm
30-1185	Standard Delicate	1.2 mm	5 in	127 mm
30-1190	Standard Pattern	2.0 mm	7 in	178 mm



Children's Hospital Classic® Dressing Forceps

Dissecting End, Delicate

CODE	DESCRIPTION	LENGTH	
30-4208	Narrow Serrated Tips	5¾ in	146 mm



Forceps (Dressing)

Dressing Forceps

Serrated

CODE	DESCRIPTION	WORKING DISTANCE	LENGTH
30-4134	Tip Width 2.2 mm	$\frac{5}{8}$ in 16 mm	$5\frac{1}{2}$ in 140 mm
30-6995	Bayonet Shape	$3\frac{1}{8}$ in 80 mm	$6\frac{1}{2}$ in 165 mm

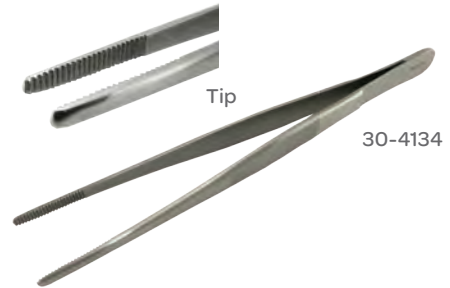

Ewald-Hudson Dressing Forceps

CODE	DESCRIPTION	TIP WIDTH	LENGTH
30-4215	Serrated	1.7 mm	5 in 127 mm

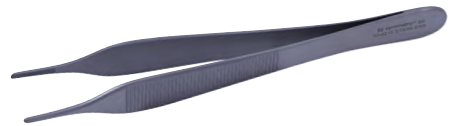

Forceps (Ear)

Hartmann Ear Forceps

CODE	DESCRIPTION	TIP SIZE	SHAFT LENGTH
30-6951	Angular, Serrated	$\frac{3}{10}$ in 7.6 mm	$3\frac{1}{2}$ in 89 mm

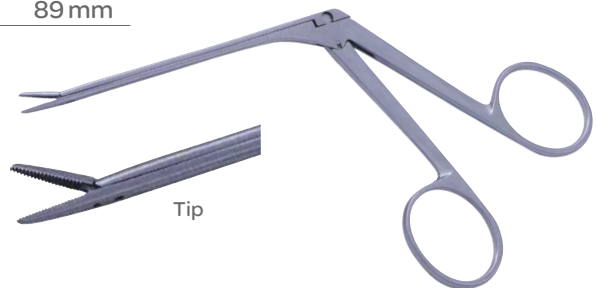

Lucae Ear Forceps

Bayonet Shape

CODE	WORKING DISTANCE	TIP WIDTH	LENGTH
30-6898	$2\frac{3}{4}$ in 70 mm	2.0 mm	$5\frac{1}{2}$ in 140 mm

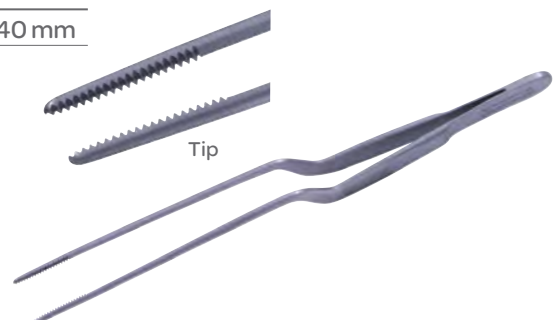

Forceps (Eye Dressing Hemostatic)

Eye Dressing Hemostatic Forceps

CODE	DESCRIPTION	TIP WIDTH	LENGTH
30-6520	Straight	1.0 mm	4 in 102 mm
30-6524	Curved	1.0 mm	4 in 102 mm



Forceps (Hemostatic)

Crile Classic® Hemostatic Forceps

CODE	DESCRIPTION	LENGTH
30-4467	Straight, Delicate	5½ in 140 mm
33-4030	Straight, Bright Finish	5½ in 140 mm
32-4030	Straight, Standard Line	5½ in 140 mm
30-4468	Curved, Delicate	5½ in 140 mm
32-4031	Curved, Standard Line	5½ in 140 mm



30-4467

Halsted Hemostatic Forceps

CODE	DESCRIPTION	LENGTH
30-4105	Straight, 1x2 Teeth	5 in 127 mm
30-4106	Curved, 1x2 Teeth	5 in 127 mm



30-4105

Kelly Classic® Hemostatic Forceps

CODE	DESCRIPTION	LENGTH
33-4020	Straight, Bright Finish	5½ in 140 mm
32-4020	Straight, Standard Line	5½ in 140 mm
34-4021	Curved, Low-Glare	5½ in 140 mm
32-4021	Curved, Standard Line	5½ in 140 mm



32-4020

Forceps (Hemostatic)

Kocher Hemostatic Forceps

CODE	DESCRIPTION	TEETH	LENGTH
32-4100	Straight, Bright Finish	1x2	5½ in 140 mm



Lahey Hemostatic Forceps

CODE	DESCRIPTION	LENGTH
30-4020	Straight with Full Serrations	5½ in 140 mm
30-4021	Curved with Full Serrations	5¾ in 146 mm



30-4020

Mixer Classic® Hemostatic Forceps

CODE	DESCRIPTION	LENGTH
30-4485	Right Angle, Delicate	5½ in 140 mm



Mosquito Classic® Hemostatic Forceps

CODE	DESCRIPTION	LENGTH
30-4471	Straight	4 in 102 mm
30-4472	Curved	4 in 102 mm
30-4474	Curved	5 in 127 mm
30-4470	Curved	6 in 152 mm



30-4470

Forceps (Hemostatic)

Providence Hospital Hemostatic Forceps

CODE	DESCRIPTION	LENGTH
32-4011	Curved, Bright Finish	5½ in 140 mm



Rochester Pean Classic® Forceps

CODE	DESCRIPTION	LENGTH
30-4462	Curved, Delicate	5½ in 140 mm

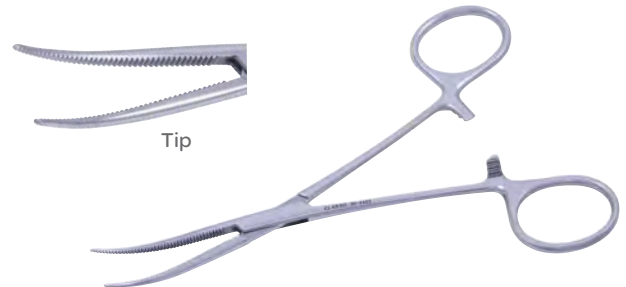

Skillman Forceps

CODE	DESCRIPTION	LENGTH
30-4009	Curved	5 in 127 mm



Forceps (MagnaFree®)

Crile MagnaFree® Forceps

Non-Magnetic, Titanium, MRI Safe up to 1.5 Tesla

CODE	DESCRIPTION	LENGTH
65-2418	Straight	5½ in 140 mm
65-2419	Curved	5½ in 140 mm



65-2419

Forceps (Micro)

Forceps

Straight

CODE	DESCRIPTION	CLOSING PRESSURE	TIP WIDTH	LENGTH
80-6001	Ring Tip, Titanium	(Appx.) 50 gms	1.0 mm	6 in 152 mm
80-6002	Ring Tip, Serrated, Titanium	(Appx.) 50 gms	1.0 mm	6 in 152 mm
80-6631	Extra Fine Utility	(Appx.) 25 gms	0.3 mm	6 in 152 mm



Micro Forceps

CODE	DESCRIPTION	TIP WIDTH	LENGTH
80-2000	Straight	0.3 mm	5½ in 140 mm



Forceps (Micro Cup)

Rhoton® Micro Cup Forceps

Alligator Action

CODE	DESCRIPTION	TIP WIDTH	LENGTH
53-4005	Straight	1.0 mm	6 in 152 mm
53-4008	Straight	2.0 mm	6 in 152 mm
53-4007	Left	1.0 mm	6 in 152 mm
53-4006	Right	2.0 mm	6 in 152 mm



Forceps (Hemostatic)

Halsted Classic® Mosquito Forceps

CODE	DESCRIPTION	LENGTH
33-4000	Straight, Bright Finish	5 in 127 mm
34-3900	Straight, Low-Glare Finish	3½ in 89 mm
32-3900	Straight, Standard Line	3½ in 89 mm
32-4000	Straight, Standard Line	5 in 127 mm
33-3901	Curved, Bright Finish	3½ in 89 mm
33-4001	Curved, Bright Finish	5 in 127 mm
34-3901	Curved, Low-Glare Finish	3½ in 89 mm
34-4001	Curved, Low-Glare Finish	5 in 127 mm
32-3901	Curved, Standard Line	3½ in 89 mm
32-4001	Curved, Standard Line	5 in 127 mm



Forceps (Pediatric Nasal)

Weil-Blakesley Delicate Pediatric Nasal Forceps

CODE	DESCRIPTION	LENGTH
63-7424	45°	6¼ in 160 mm
63-7425	90°	6¼ in 160 mm
63-7423	Straight	6¼ in 160 mm
63-7423S	Straight with Suction	6¼ in 160 mm
63-7424S	Upturned 45° with Suction	6¼ in 160 mm



Forceps (Scalp)

Raimondi Scalp Forceps

Curved On Side

CODE	DESCRIPTION	TEETH	LENGTH
30-1360	Infant Scalp	1x2	5 in 127 mm

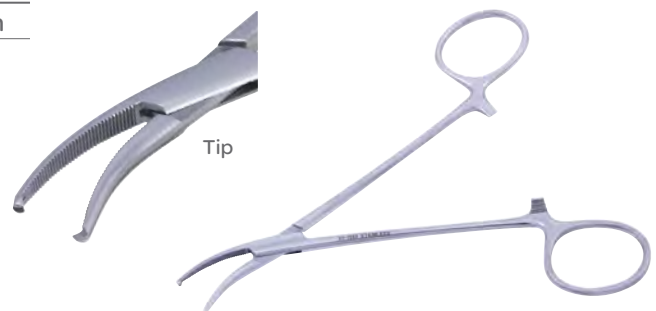

Forceps (Suture Tag)

Castaneda Suture Tag Forceps

CODE	DESCRIPTION	LENGTH
30-9007	1, Smooth Jaws	3½ in 89 mm
30-9008	2, Smooth Jaws	3½ in 89 mm
30-9009	3, Smooth Jaws	3½ in 89 mm
30-9010	4, Smooth Jaws	3½ in 89 mm



30-9007

Forceps (Tissue)

Allis Classic® Tissue Forceps

CODE	DESCRIPTION	TEETH	LENGTH
30-4466	Delicate	5x6	5 in 127 mm

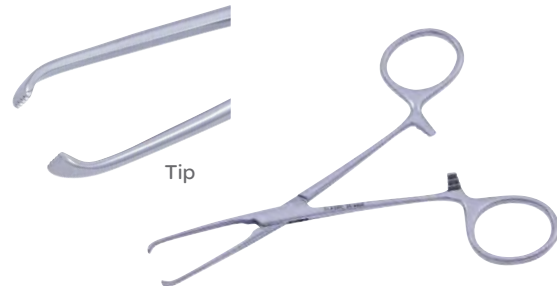

Iris Tissue Forceps

CODE	DESCRIPTION	TEETH	TIP WIDTH	LENGTH
30-6530	Straight	1x2	0.5mm	4 in 102 mm

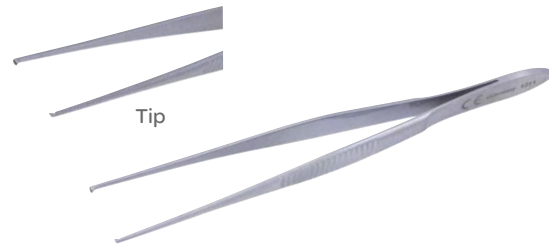

Forceps (Vascular)

DeBakey-Diethrich Vascular Forceps

Straight, Fine, Titanium

CODE	TIP WIDTH	LENGTH
30-8131	2.0 mm	6 in 153 mm
30-8400	1.8 mm	6 in 153 mm



30-8400

Hooks (Dural)

Cushing Dural Hook

CODE	TIP DIAMETER	LENGTH
38-1028	2.0 mm	5½ in 140 mm



Frazier Dural Hook

CODE	TIP DIAMETER	LENGTH
38-1040	0.4 mm	5 in 127 mm



Lahey Clinic Dural Hook

CODE	DESCRIPTION	DEPTH	LENGTH
38-1042	Sharp	2.8 mm	5¼ in 133 mm



Hooks (Eye)

Guthrie Eye Fixation Hook

Two Sharp Teeth

CODE	DESCRIPTION	TIP WIDTH	LENGTH
38-6530	Standard	2.0 mm	4¾ in 121 mm
38-6531	Delicate	1.0 mm	5¼ in 133 mm

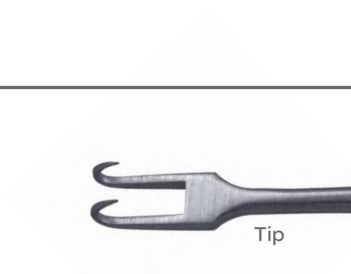

38-6530

Hooks (Eye)

Tyrell Iris Hook

CODE	DESCRIPTION	TIP WIDTH	LENGTH
38-6525	Sharp	0.4 mm	4 ¾ in 121 mm



Hooks (Skin)

Carroll Skin Hook

CODE	DESCRIPTION	HOOK SIZE	LENGTH
38-2515	Sharp	¼ in 3.0 mm	6 in 152 mm



Needle Holders (Extra Fine)

Extra Fine Needle Holder

CODE	DESCRIPTION	TIP WIDTH	LENGTH
80-6621	Curved, Titanium	0.5 mm	6 in 152 mm



Needle Holders (I.M.A.)

Jones I.M.A. Classic Plus® Needle Holder

CODE	DESCRIPTION	LENGTH
36-3018	Straight	6 in 152 mm

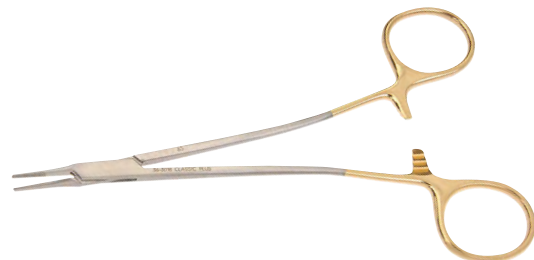

Needle Holders (Micro)

Micro Needle Holder

CODE	DESCRIPTION	TIP WIDTH	LENGTH
80-2002	Straight Tip	0.5 mm	5½ in 140 mm
80-2003	Curved Tip	0.5 mm	5½ in 140 mm



80-2002

Needle Holders (Microsurgical)

Castroviejo Microsurgical Classic Plus® Needle Holder

Smooth Tungsten Carbide Jaw Inserts with Catch

CODE	DESCRIPTION	LENGTH
36-1006	Needle Holders	5½ in 140 mm
36-1007	Needle Holders	7 in 178 mm
36-1008	Needle Holders	8½ in 216 mm



36-1006

Needle Holders (Total Occlusion)

Total Occlusion Needle Holder

Tungsten Carbide Inserts

CODE	DESCRIPTION	LENGTH
37-4029	Smooth Jaws	4¾ in 121 mm



Baumgartner Classic Plus® Needle Holder

CODE	DESCRIPTION	LENGTH
36-2010	Tungsten Carbide Jaw Inserts	5 in 127 mm



Needle Holders

Baumgartner Needle Holder

CODE	DESCRIPTION	LENGTH
64-2511	Stainless Steel	5 in 127 mm

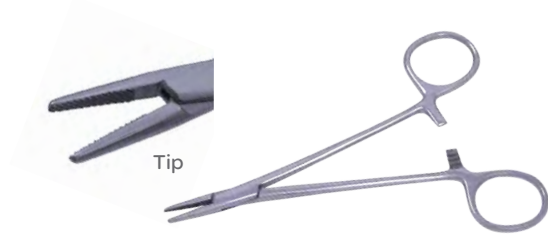

Crile-Wood Needle Holder

CODE	DESCRIPTION	LENGTH
64-2509	Stainless Steel Jaws	6 in 152 mm



Needle Holders

Curved, Titanium

CODE	DESCRIPTION	TIP WIDTH	LENGTH
80-6006	Fine Tip	0.7 mm	6 in 152 mm
80-6007	Standard Tip	1.0 mm	6 in 152 mm



Mayo-Hegar Needle Holder

CODE	DESCRIPTION	LENGTH
36-2015	Tungsten Carbide Jaw Inserts	5 in 127 mm
36-2016	Tungsten Carbide Jaw Inserts	6 in 152 mm



36-2015

Ryder Classic Plus® Needle Holder

Tungsten Carbide Jaw Inserts

CODE	DESCRIPTION	JAW WIDTH	LENGTH
36-3023	Serrated Jaws	1.0 mm	5 in 127 mm
36-3022	Smooth Jaws	1.0 mm	5 in 127 mm



Probes (Lachrymal)

Bowman Probe

Double-Ended, Malleable, Silver

CODE	DESCRIPTION	LENGTH
49-6500	0000-000	4 $\frac{7}{8}$ in 124 mm
49-6501	00-0	4 $\frac{7}{8}$ in 124 mm
49-6502	1-2	4 $\frac{7}{8}$ in 124 mm
49-6503	3-4	4 $\frac{7}{8}$ in 124 mm
49-6504	5-6	4 $\frac{7}{8}$ in 124 mm
49-6505	7-8	4 $\frac{7}{8}$ in 124 mm



Punches (Pediatric Antrum)

Pediatric Rotating Backbiting Antrum Punch

CODE	SHAFT	SIZE
63-7422	10.5 cm, Left-Side Cutting	1.5 x 5.0 mm
63-7421	10.5 cm, Right-Side Cutting	1.5 x 5.0 mm
63-7415	Rotates 360°, 1.5 x 5.0 mm Bite	1.5 x 5.0 mm
63-7420	With Rotation Post	1.5 x 5.0 mm
63-7416		1.5 x 5.0 mm



Rasps (Rib)

Alexander-Farabeuf Raspatory

CODE	DESCRIPTION	LENGTH
54-3134	Pediatric	6 in 152 mm



Doyen Rib Rasp

CODE	DESCRIPTION	LENGTH
54-3002	Left, Pediatric	6 in 152 mm
54-3001	Right, Pediatric	6 in 152 mm

Retractors (Blade)



50-1050

Cloward Blade

CODE	DESCRIPTION	BLADE WIDTH	LENGTH
50-1050		18 mm	3 x 4 1/2 in 76 x 114 mm
50-1052	20 mm	20 mm	3 x 4 1/2 in 76 x 114 mm
50-1053	23 mm	23 mm	3 x 4 1/2 in 76 x 114 mm

Retractors (Dural Suction)



Dural Suction Retractor

CODE	ANGLE	TIP WIDTH	TIP DEPTH	WORKING DISTANCE	HANDLE LENGTH
46-3012	90°, Black, Micro	$\frac{9}{32}$ in 8.0 mm	$\frac{1}{4}$ in 6.0 mm	4 $\frac{3}{4}$ in 120 mm	4 $\frac{5}{8}$ in 117 mm

Retractors (Epicardial)



I.M.A. Epicardial Retractor

CODE	DESCRIPTION	LENGTH
80-1864	Mini, Gold Coated	1 in 25 mm



Parsonnet Epicardial Retractor

CODE	DESCRIPTION	PRONGS	LENGTH
37-4035	Self Retaining, Light Tension	3 x 3 Sharp	1 $\frac{7}{8}$ in 47 mm

Retractors (Hand-Held)



50-5645



50-4100

Children's Hospital Retractor

Double-Ended

CODE	DESCRIPTION	BLADE WIDTH	BLADE DEPTH	LENGTH
50-5645	S-Shaped	¼ in 6.0 mm ½ in 13 mm	¾ in 19 mm ¾ in 19 mm	4 7/8 in 124 mm
50-4100	Small	7/16 in 11 mm 9/16 in 14 mm	7/8 in 22 mm 1 3/8 in 35 mm	5 ½ in 140 mm

Crile Retractor



CODE	DESCRIPTION	BLADE WIDTH	BLADE DEPTH	LENGTH
50-4105	Crile Retractor, Double-Ended	¼ in 6.0 mm 3/16 in 5.0 mm	¾ in 19 mm 5/8 in 16 mm	4 ¼ in 108 mm

Pediatric Deaver Retractor

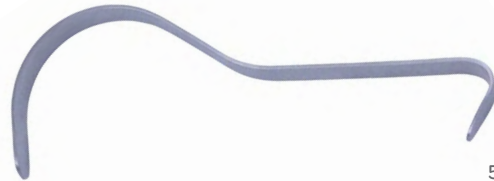

50-5630

CODE	DESCRIPTION	LENGTH
50-5630	Standard Handle	8 x 5/8 in 203 x 16 mm
50-5631	Standard Handle	8 x 2 ½ x 1 in 203 x 64 x 25 mm

Retractors (Sternal)



50-8060

Castaneda Infant Sternal Retractor

CODE	SIZE	ARM LENGTH	BLADE WIDTH	TOTAL OPENING	BLADE DEPTH
50-8060	Small	2 5/8 in 67 mm	1 7/16 in 36 mm	3 in 76 mm	3/8 in 10 mm
50-8061	Large	3 in 76 mm	2 ½ in 64 mm	3 ½ in 89 mm	7/16 in 11 mm

Retractors (Sternal)



Castaneda Infant Sternal Retractor

CODE	DESCRIPTION	ARM LENGTH		BLADE LENGTH		BLADE DEPTH	SPREAD
54-1009	Aluminum Arms and Blades	3 $\frac{3}{8}$ in	79 mm	3 $\frac{3}{4}$ in	19 mm	1 $\frac{1}{2}$ in 13 mm	4 in 102 mm

Retractors (Laminectomy)



Poppen-Gelpi Laminectomy Retractor

CODE	DESCRIPTION	TOTAL OPENING		LENGTH
50-1212	Self-Retaining	2 $\frac{1}{2}$ in	64 mm	5 $\frac{1}{2}$ in 140 mm

Retractors (Nerve Root)



Weary Nerve Root Retractor

CODE	BLADE WIDTH	SHAFT LENGTH	HANDLE LENGTH
50-1310	7 $\frac{1}{16}$ in 11 mm	5 $\frac{3}{4}$ in 146 mm	5 $\frac{3}{4}$ in 146 mm

Scoville Nerve Root Retractor



CODE	ANGLE	BLADE WIDTH	SHAFT LENGTH	HANDLE LENGTH
50-1293	90°	1 $\frac{1}{2}$ in 13 mm	4 $\frac{1}{4}$ in 107 mm	5 in 127 mm

Retractors (Skin)



Microvascular Modified Alm Retractor

CODE	DESCRIPTION	PRONGS	LENGTH
80-1812	Black Anodized	4 x 4	3 in 76 mm
80-1813	Black Anodized	12 x 12	3 ¾ in 95 mm

Retractors (Pediatric)

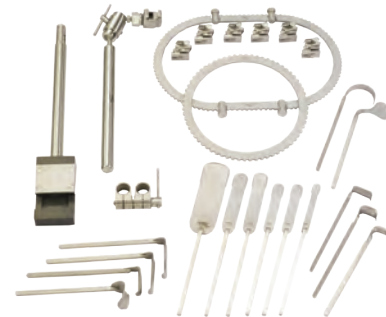

U.B. Pediatric System

CODE	DESCRIPTION
58-0145	Complete System

Retractors (Rib)



Cooley Pediatric Rib Retractor

CODE	DESCRIPTION	ARM LENGTH	BLADE LENGTH	BLADE DEPTH	SPREAD
54-2101	Aluminum Arms & Blades	3 ⅞ in 79 mm	1 in 25 mm	⅝ in 16 mm	4 ¾ in 121 mm



Burford Rib Retractor

Child Model, Self-Retaining with Rack and Pinion Action, Aluminum

CODE	SIZE	BLADE WIDTH	BLADE DEPTH	ARM LENGTH	TOTAL OPENING
50-8133	Small Slide Blades	1 ⅝ in 41 mm	1 ⅜ in 35 mm	6 in 152 mm	6 in 152 mm
	Large Slide Blades	1 ⅝ in 41 mm	1 ⅞ in 48 mm		

Retractors (Rib)



Rib Retractor

Infant, Self-Retaining with Rack and Pinion Action, Aluminum

CODE	ARM LENGTH	BLADE WIDTH	BLADE DEPTH	LENGTH
50-5625	3 in 76 mm	$\frac{3}{4}$ in 19 mm	$\frac{13}{16}$ in 21 mm	2½ in 64 mm



Rib Retractor-Contractor

Self-Retaining with Rack and Pinion Action, Aluminum

CODE	ARM LENGTH	BLADE WIDTH	BLADE DEPTH	LENGTH
50-8057	3¼ in 83 mm	$\frac{7}{8}$ in 22 mm	$\frac{3}{4}$ in 19 mm	2½ in 64 mm

Retractors (Scalp)



Contour Scalp Retractor

Self-Retaining, with Blades Curved to Fit Contour of Skull

CODE	PRONGS	TOTAL OPENING	BLADE WIDTH	BLADE DEPTH	LENGTH
50-1220	3 x 4 Blunt	2½ in 64 mm	$\frac{5}{8}$ in 16 mm	$\frac{5}{8}$ in 16 mm	5½ in 140 mm

Retractors (Scapular)



Davidson Scapular Retractor

CODE	HANDLE LENGTH	BLADE WIDTH	BLADE DEPTH	LENGTH
50-8096	6 in 152 mm	3½ in 89 mm	3 in 76 mm	3½ in 89 mm

Retractors (Scapular, Self-Retaining)



24-1007

Alm Retractor

CODE	DESCRIPTION	LENGTH
24-1007	Sharp, 4 x 4	2 3/4 in 70 mm
24-1008	Blunt, 4 x 4	2 3/4 in 70 mm



Cervical Retractor Set

CODE	DESCRIPTION	LENGTH
50-1390	Small, Self-Retaining with 7 Pairs of Blunt Blades	6 x 3 3/4 in 152 x 95 mm



50-1392

Retraction Blades

CODE	DESCRIPTION	BLADE DEPTH
50-1391	Blunt	25 mm
50-1392	Blunt	30 mm
50-1393	Blunt	35 mm
50-1394	Blunt	40 mm
50-1395	Blunt	45 mm
50-1396	Blunt	50 mm
50-1397	Blunt	55 mm



Cervical Retractor Body

CODE	DESCRIPTION
50-1356	Small

Retractors (Self-Retaining)



50-5651

Balfour Abdominal Retractor Miniature Model

CODE	DESCRIPTION	LENGTH
50-5651	Self Retaining, Fixed Lateral Fenestrated Blades, One Center Blade	1 in 25 mm

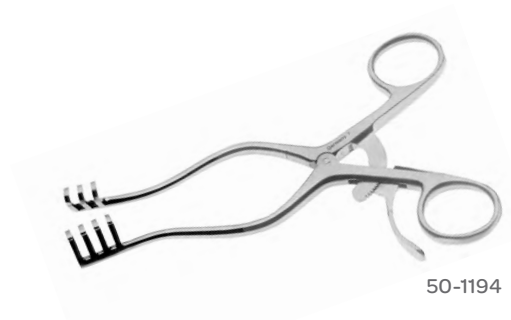

50-1194

Weitlaner Retractor

CODE	DESCRIPTION	TOTAL OPENING	PRONGS	LENGTH
50-1195	Self-Retaining Prongs, Blunt	2¼ in 57 mm	3 x 4	5½ in 140 mm
50-1194	Self-Retaining Prongs, Sharp	2¼ in 57 mm	3 x 4	5½ in 140 mm
50-5646	Self-Retaining Prongs, Sharp	2¼ in 57 mm	2 x 3	2¼ x 4½ in 57 x 114 mm
50-5647	Self-Retaining Prongs, Blunt	2¼ in 57 mm	2 x 3	2¼ x 4½ in 57 x 114 mm



Infant Weitlaner Retractor

CODE	DESCRIPTION	PRONGS	LENGTH
61-0610	Blunt	3 x 3	4½ in 114 mm

Retractors (Spring)

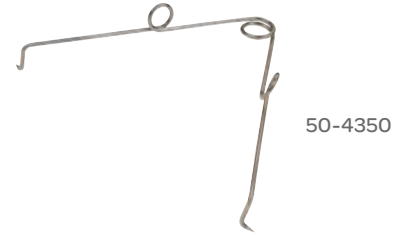

Spring Retractor

CODE	DESCRIPTION	PRONGS	LENGTH	
24-0301	Sharp	1x1	3 1/2 in	89 mm
50-4350	Self-Retaining, Sharp	1	3/8 x 3 1/8 in	10 x 79 mm
50-4351	Self-Retaining, Semi-Sharp Blade	3	7/16 x 9/16 x 3 1/4 in	11 x 14 x 83 mm
24-0301-H	With Heavy Wire, Sharp	1x1	3 1/2 in	89 mm
24-0302-H	With Heavy Springs, Sharp	1x1	4 1/2 in	114 mm

Retractors (Sternal)



Ankeney Sternal Retractor

Child Size, Aluminum, with Stainless Steel Rack

CODE	ARM LENGTH	BLADE WIDTH	BLADE DEPTH	TOTAL OPENING
50-8068	4 1/2 in 114 mm	3/4 in 19 mm	1 in 25 mm	5 in 127 mm



Morse Sternal Retractor

Child Size, Self-Retaining with Rack and Pinion Action

CODE	ARM LENGTH	BLADE WIDTH	BLADE DEPTH	TOTAL OPENING
50-8066	6 1/8 in 156 mm	3/4 in 19 mm	3/4 in 19 mm	6 1/4 in 159 mm

Rib Spreaders (Sternal)



Premie Rib Spreader

CODE	ARM LENGTH	BLADE WIDTH	BLADE LENGTH	SPREAD
54-1000	1 in 25 mm	1/4 in 6.0 mm	1/4 in 6.0 mm	1 9/16 in 40 mm

Rongeurs (Intervertebral Disc)

Schlesinger Cervical Laminectomy Rongeur

CODE	DESCRIPTION	BITE	LENGTH
53-1382	Down Biting Shaft	3.0 mm	6 in 152 mm
53-1380	Up Biting Shaft	3.0 mm	6 in 152 mm
53-1381	Up Biting Shaft	5.0 mm	6 in 152 mm



Cushing Intervertebral Disc Rongeur

Cup Shaped Jaws

CODE	DESCRIPTION	CUP	LENGTH
53-1290	Straight	2.0 x 10 mm	5 in 127 mm
53-1291	Curved Up	2.0 x 10 mm	5 in 127 mm



Hoen Intervertebral Disc Rongeur

CODE	DESCRIPTION	CUP	LENGTH
53-1224	Fenestrated Jaws	4.0 x 12 mm	5½ in 140 mm



Peapod Intervertebral Disc Rongeur

CODE	DESCRIPTION	CUP	LENGTH
53-1255	Curved Up	2.0 x 6.0 mm	5½ in 140 mm



Selverstone Intervertebral Disc Rongeur

CODE	DESCRIPTION	CUP	LENGTH
53-1325	Straight	2.0 x 3.0 mm	6 in 152 mm
53-1326	Straight	2.0 x 5.0 mm	6 in 152 mm



Rongeurs (Intervertebral Disc)

Spurling Intervertebral Disc Rongeur

CODE	DESCRIPTION	CUP	LENGTH
53-1300	Straight	4.0x10 mm	6 in 152 mm



Wilde Intervertebral Disc Rongeur

CODE	DESCRIPTION	CUP	LENGTH
53-1280	Straight #1	5.0x15 mm	5½ in 140 mm
53-1281	Straight #2	5.2x15 mm	5½ in 140 mm



Rongeurs (Bone Cutting)

Liston Bone Cutting Forceps

CODE	DESCRIPTION	LENGTH
30-1310	Straight	5½ in 140 mm



Rongeurs (Laminectomy)

Kerrison Laminectomy Rongeur

CODE	DESCRIPTION	BITE	LENGTH
53-1374	Down Biting Shaft	3.0 mm	6 in 152 mm
53-1375	Down Biting Shaft	5.0 mm	6 in 152 mm
53-1370	Up Biting Shaft	3.0 mm	6 in 152 mm
53-1371	Up Biting Shaft	5.0 mm	6 in 152 mm



Scissors (Corneal)

Castroviejo Corneal Scissors

CODE	DESCRIPTION	LENGTH
54-6571	Curved Tip	4¼ in 108 mm



Scissors (Delicate)

Delicate Scissors

CODE	DESCRIPTION	LENGTH
54-2515	Straight, Blunt	4½ in 114 mm
54-5567	Curved with Dissecting End	4⅞ in 124 mm
54-5571	Curved, Delicate	5¾ in 146 mm



Scissors (Dissecting)

Delicate Dissecting Scissors

CODE	DESCRIPTION	LENGTH
54-5566	Curved	5 in 127 mm



Mayo Classic Plus® Dissecting Scissors

Stellite Edge Inserts

CODE	DESCRIPTION	LENGTH
36-5050	Straight	5½ in 140 mm
36-5060	Curved	5½ in 140 mm



36-5050

Scissors (Dissecting)

Mayo Dissecting Scissors

Beveled Blades

CODE	DESCRIPTION	LENGTH
54-4098	Straight	5½ in 140 mm
54-4099	Curved	5½ in 140 mm



54-4098

Metzenbaum Classic® Plus Dissecting Scissors

Delicate Stellite Edge Inserts

CODE	DESCRIPTION	LENGTH
36-5030	Curved, Sharp/Sharp	5¾ in 146 mm
36-5031	Curved, Blunt/Blunt	5¾ in 146 mm



36-5031

Metzenbaum Dissecting Scissors

CODE	DESCRIPTION	LENGTH
54-1023	Curved	5 in 127 mm



Scissors (Dural)

Taylor Dural Scissors

CODE	DESCRIPTION	LENGTH
54-1050	Scissors	5¾ in 146 mm



Scissors (Fine)

Fine Scissors

CODE	DESCRIPTION	LENGTH
54-1075	Straight, Sharp/Sharp	4½ in 114 mm
54-1076	Curved, Sharp/Sharp	4½ in 114 mm



54-1075

Scissors (Iris)

Iris Classic Plus® Scissors

CODE	DESCRIPTION	LENGTH
34-6500	Straight, Sharp/Sharp	4¾ in 111 mm
34-6503	Curved, Sharp/Sharp	4¾ in 111 mm



34-6500

Iris Classic® Scissors

Stellite Edge Inserts

CODE	DESCRIPTION	LENGTH
36-5000	Straight, Sharp/Sharp	4½ in 114 mm
36-5001	Curved, Sharp/Sharp	4½ in 114 mm



36-5000

Iris Scissors

CODE	DESCRIPTION	LENGTH
54-6500	Straight, Sharp/Sharp	4¾ in 111 mm
54-6503	Curved, Sharp/Sharp	4¾ in 111 mm



54-6500

Scissors (Iris)

Knapp Iris Scissors

CODE	DESCRIPTION	LENGTH
54-6524	Straight, Sharp/Blunt	4 in 102 mm
54-6526	Straight, Blunt, Blunt	4 in 102 mm
54-6525	Curved, Sharp/Blunt	4 in 102 mm
54-6527	Curved, Blunt, Blunt	4 in 102 mm



54-6524

Scissors (Micro)

Micro Scissors

CODE	DESCRIPTION	LENGTH
80-2005	Straight Tip	5½ in 140 mm
80-2006	Curved Tip	5½ in 140 mm

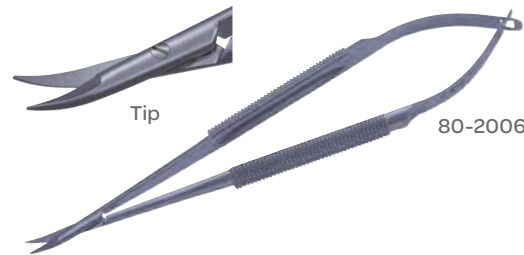

80-2006

Scissors (Microsurgical)

Decker Microsurgical Scissors

Alligator Action

CODE	DESCRIPTION	BLADELENGTH	LENGTH
54-5604	Straight	5.0 mm	5½ in 140 mm
54-5605	Curved Left	5.0 mm	5½ in 140 mm
54-5606	Curved Right	5.0 mm	5½ in 140 mm

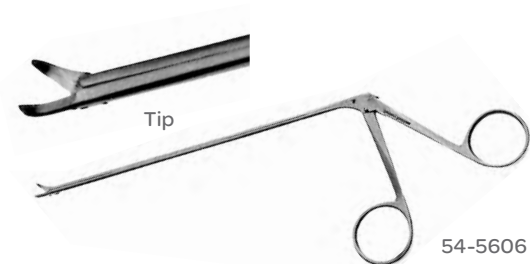

54-5606

Scissors

Titanium, Serrated Jaws

CODE	DESCRIPTION	LENGTH
80-6008	Straight, Fine Tip	6 in 152 mm
80-6009	Straight, Regular Tip	6 in 152 mm



80-6009

Scissors (Operating)

Classic® Mayo Scissors

CODE	DESCRIPTION	LENGTH
34-4098	Straight, Beveled Blades	5 ½ in 140 mm



Deaver Operating Scissors

CODE	DESCRIPTION	LENGTH
54-4066	Straight, Sharp/Blunt	5 ½ in 140 mm



Operating Classic Plus® Scissors

Stellite Edge Inserts

CODE	DESCRIPTION	LENGTH
36-5040	Straight, Sharp/Blunt	5 ½ in 140 mm



Scissors (Operating)

Operating Scissors

CODE	DESCRIPTION	LENGTH	
54-4026	Straight, Sharp/Blunt	5 in	127 mm
54-4027	Straight, Sharp/Sharp	5 in	127 mm
54-4028	Straight, Blunt/Blunt	5 ½ in	140 mm
54-4029	Straight, Sharp/Blunt	5 ½ in	140 mm
54-4030	Straight, Sharp/Sharp	5 ½ in	140 mm
54-4032	Straight, Sharp/Blunt	6 in	153 mm
54-4300	Straight, Sharp/Blunt, Delicate	5 in	127 mm
54-4301	Straight, Sharp/Sharp, Delicate	5 in	127 mm
54-4306	Straight, Sharp/Blunt, Delicate	5 ½ in	140 mm



Scissors (Pituitary)

Sweet Pituitary Scissors

CODE	DESCRIPTION	BLADE LENGTH	LENGTH
54-1091	Straight, Alligator Blades	¾ in 10 mm	5 ½ in 140 mm



Scissors (Sinus)

Sinus Scissors

CODE	DESCRIPTION	BLADES	LENGTH
63-7700	Straight, Pediatric	5.0 mm	5 ¾ in 146 mm
63-7701	Left, Pediatric	5.0 mm	5 ¾ in 146 mm
63-7702	Right, Pediatric	5.0 mm	5 ¾ in 146 mm



Scissors (Stitch)

Littauer Stitch Scissors

CODE	DESCRIPTION	LENGTH
54-4017	Scissors	5½ in 140 mm



Shortbent Stitch Scissors

CODE	DESCRIPTION	LENGTH
54-2555	Curved on Side	3½ in 89 mm



Spencer Stitch Scissors

CODE	DESCRIPTION	LENGTH
54-6624	Scissors	3½ in 89 mm
54-4205	Scissors	4½ in 114 mm



54-6624

Wescott Stitch Scissors

CODE	DESCRIPTION	LENGTH
54-6630	Sharp/Sharp	4¼ in 108 mm



Scissors (Strabismus)

Classic® Strabismus Scissors

CODE	DESCRIPTION	LENGTH
34-6517	Curved, Blunt/Blunt	4½ in 114 mm



Strabismus Classic Plus® Scissors

Stellite Edge Inserts

CODE	DESCRIPTION	LENGTH
36-5005	Straight, Blunt/Blunt	4½ in 114 mm



Strabismus Scissors

CODE	DESCRIPTION	LENGTH
54-6515	Straight, Blunt/Blunt	4½ in 114 mm
54-6517	Curved, Blunt/Blunt	4½ in 114 mm



54-6517

Scissors (Tenotomy)

Jamison Metzenbaum Tenotomy Scissors

CODE	DESCRIPTION	LENGTH
37-4033	Curved	6 in 152 mm



Scissors (Tenotomy)

Stevens Tenotomy Scissors

CODE	DESCRIPTION	LENGTH
54-6520	Straight	4 $\frac{1}{8}$ in 105 mm
54-6522	Straight	4 $\frac{5}{8}$ in 118 mm
54-6521	Curved	4 $\frac{1}{8}$ in 105 mm
54-6523	Curved	4 $\frac{5}{8}$ in 118 mm



54-6520

Wescott Tenotomy Scissors

CODE	DESCRIPTION	LENGTH
54-6513	Blunt/Blunt	4 $\frac{1}{4}$ in 108 mm



Mattox-Potts Scissors

CODE	ANGLE	BLADE LENGTH	TOTAL LENGTH
54-8004	45°	$\frac{13}{16}$ in 21 mm	5 $\frac{1}{2}$ in 140 mm



Scissors (Vascular)

Vascular Scissors

CODE	ANGLE	BLADE WIDTH	BLADE LENGTH	LENGTH
54-8008	45°	$\frac{3}{16}$ in 5.0 mm	$\frac{1}{2}$ in 13 mm	5 $\frac{1}{4}$ in 130 mm



Scissors (Wire Suture)

Wire Cutting Suture Scissors

CODE	DESCRIPTION	LENGTH
54-4210	Serrated Blades	4½ in 114 mm



Wire Suture Scissors

CODE	DESCRIPTION	LENGTH
54-4110	Angled, One Serrated Jaw	4¾ in 121 mm



Sounds (Infant Urethral)



51-6808

McCrea Infant Urethral Sound

CODE	DESCRIPTION	LENGTH
51-6808	8 French, Curved, Plain Tip	7 in 17.5 cm
51-6810	10 French, Curved, Plain Tip	7 in 17.5 cm

Speculum (Eye)



Barraquer Eye Specula

CODE	DESCRIPTION
60-1962	Pediatric, 5.0 mm Wide

Suction Tubes (Dural)



Dural Suction Retractor

CODE	DESCRIPTION	TIP WIDTH	TIP DEPTH	WORKING DISTANCE	HANDLE LENGTH
46-3013	Standard Macro, Black	3/8 in 10 mm	1/4 in 6.0 mm	4 3/4 in 120 mm	4 1/2 in 114 mm

Suction Tubes (Pediatric)

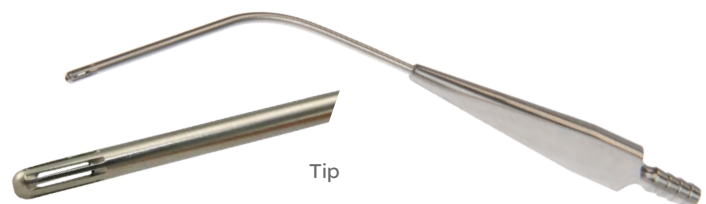

Pediatric Suction Tube

CODE	DESCRIPTION
09-8520	#1, Fixed Tip, Fluted

Suction Tubes (Pediatric)

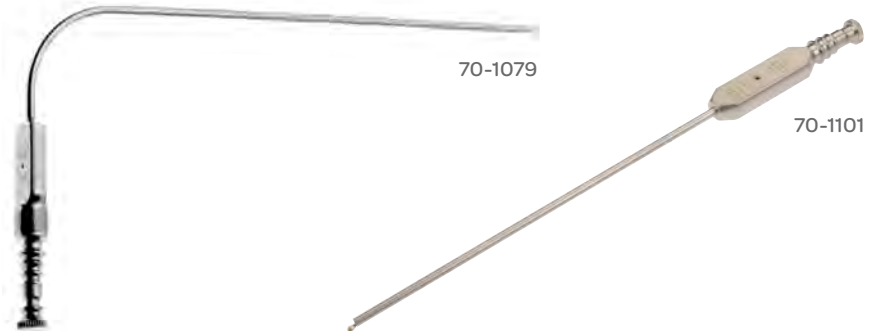

Frazier Suction Tube

CODE	DESCRIPTION	DIAMETER	LENGTH
70-1101	Straight	9 French with Thumb Control	5¼ in 133 mm
70-1102	Straight	11 French with Thumb Control	5¼ in 133 mm
70-1079	Angular	7 French with Thumb Control	4½ in 114 mm
70-1005	Angular	7 French with Thumb Control, Insulated	4½ in 114 mm
70-1087	Angular	7 French with Thumb Control	7½ in 191 mm
70-1080	Angular	9 French with Thumb Control	4½ in 114 mm
70-1081	Angular	11 French with Thumb Control	4½ in 114 mm
70-1089	Angular	11 French with Thumb Control	7½ in 191 mm
70-1017	Angular	11 French with Thumb Control, Insulated	7½ in 191 mm



Malis® Frazier Suction Tube

CODE	DESCRIPTION	LENGTH
70-1103	7 French, Black Anodized	4¼ in 108 mm



Pribram Suction Tube

70-1128

CODE	DESCRIPTION	LENGTH
70-1128	16 Gauge with Thumb Control	5½ in 140 mm
70-1130	18 Gauge with Thumb Control	5½ in 140 mm

Tissue Forceps (Dressing)

Bishop Harman Dressing Forceps

CODE	TIP WIDTH	LENGTH
30-6557	0.4 mm	3 ³ / ₈ in 86 mm

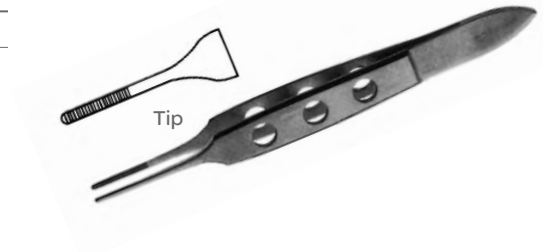

Tissue Forceps (Fixation)

Von Graefe Fixation Forceps

CODE	DESCRIPTION	TIP WIDTH	LENGTH
30-6585	Without Teeth	2.0 mm	4 ³ / ₄ in 121 mm



Tissue Forceps (Iris)

Bishop Harmon Iris Forceps

CODE	DESCRIPTION	TEETH	TIP WIDTH	LENGTH
30-6555	Standard	1x2	0.5 mm	3 ¹ / ₄ in 83 mm
30-6556	Delicate	1x2	0.3 mm	3 ¹ / ₄ in 83 mm



Tissue Forceps (Micro)

Forceps

CODE	DESCRIPTION	TIP WIDTH	LENGTH
80-6630	Straight, Extra Fine	0.7 mm	6 in 152 mm



Tissue Forceps (Tissue)

Adson Tissue Forceps

CODE	DESCRIPTION	TIP WIDTH	LENGTH
30-4218	1x2 Teeth, Delicate	0.7 mm	5 in 127 mm
30-1186	1x2 Teeth	1.2 mm	5 in 127 mm
30-1187	2x3 Teeth	1.8 mm	5 in 127 mm
30-1188	2x3 Teeth	3.0 mm	7 in 178 mm

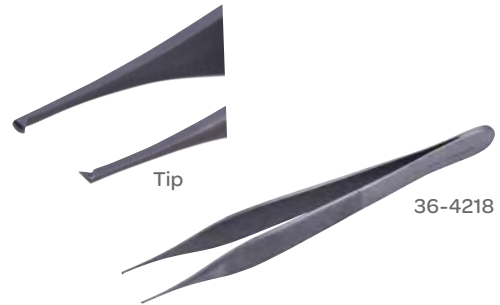

Adson Tissue Forceps

Tungsten Carbide Tip

CODE	DESCRIPTION	TIP WIDTH	LENGTH
36-6000	Serrated Jaws	2.0 mm	4 3/4 in 121 mm

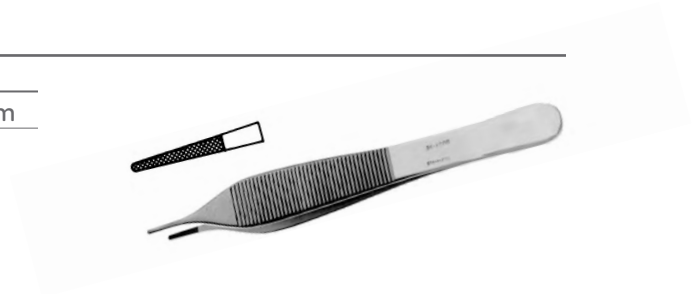

Adson Tissue Forceps

CODE	DESCRIPTION	TIP WIDTH	LENGTH
65-2413	Non-Magnetic, Titanium		5 in 127 mm



Adson-Brown Tissue Forceps

CODE	TIP WIDTH	LENGTH
30-1189	1.7 mm	5 in 127 mm



Tissue Forceps (Tissue)

Allis Classic® Tissue Forceps

Standard Line

CODE	TEETH	LENGTH
32-7000	4 x 5	6 in 152 mm
32-7001	5 x 6	6 in 152 mm

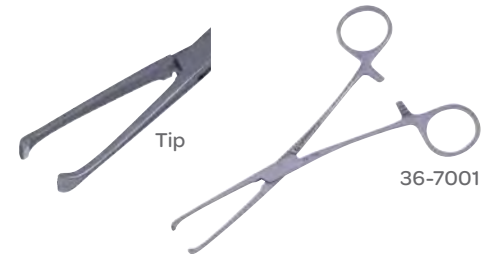

Ewald-Hudson Tissue Forceps

CODE	DESCRIPTION	TIP WIDTH	LENGTH
30-4216	1 x 2 Teeth	1.6 mm	5 in 127 mm



Iris Tissue Forceps

CODE	DESCRIPTION	TEETH	TIP WIDTH	LENGTH
30-6532	Curved	1 x 2	0.5 mm	4 in 102 mm

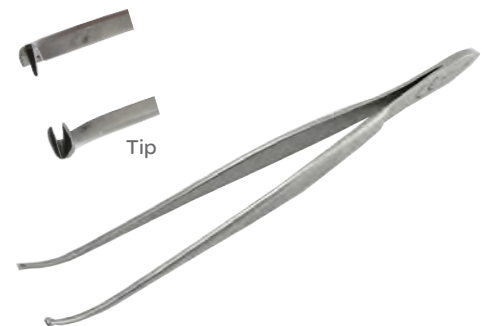

Jewelers Forceps

CODE	DESCRIPTION	LENGTH
30-6712	#3	4 3/4 in 121 mm
30-6713	#3C	4 5/16 in 109 mm
30-6714	#4	4 1/4 in 108 mm
30-6715	#5	4 5/16 in 109 mm



Tissue Forceps (Tissue)

Russian Tissue Forceps

CODE	TIP WIDTH	LENGTH
30-4220	6.0 mm	6 in 152 mm



Semkin Tissue Forceps

CODE	TIP WIDTH	LENGTH
30-1170	1.3 mm	5 in 127 mm

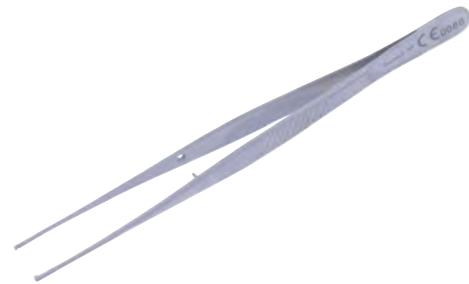

Tickner Forceps

CODE	DESCRIPTION	TIP WIDTH	LENGTH
36-6030	Tungsten Carbide Inserts	1.8 mm	6 in 152 mm



Tissue Forceps

CODE	DESCRIPTION	TIP WIDTH	LENGTH
30-4151	1x2 Teeth	2.3 mm	5 in 127 mm
30-4152	1x2 Teeth	2.3 mm	5½ in 140 mm
30-4153	1x2 Teeth	2.3 mm	6 in 152 mm
30-4161	2x3 Teeth	3.9 mm	5½ in 140 mm

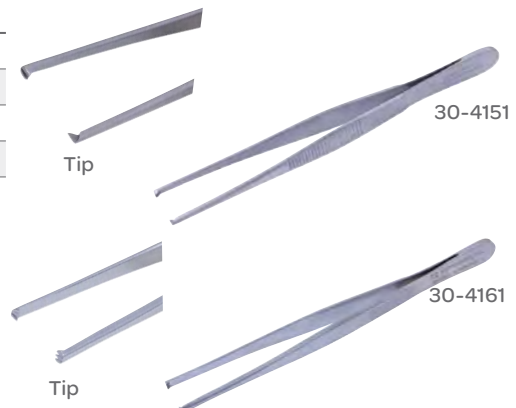

Tissue Forceps (Tissue)

Tissue Forceps

Non-Magnetic Titanium

CODE	DESCRIPTION	TIP WIDTH	LENGTH
65-2420	1 x 2 teeth	2.3 mm	5½ in 140 mm



Tissue Forceps (Utility)

Nugent Utility Forceps

CODE	DESCRIPTION	TIP WIDTH	LENGTH
30-6695	Smooth Jaw, Angled Tip	0.5 mm	4 in 102 mm



Tissue Forceps (Vascular)

Castaneda Forceps

Grooved with Cross Serrations

CODE	TEETH	TIP WIDTH	LENGTH
30-8500	1 x 2 Vascular	1.7 mm	6 in 152 mm



Tourniquets (Obturator)

Rumel Obturator

CODE	DESCRIPTION	LENGTH
67-8004	Child, Obturator Only	6 in 152 mm

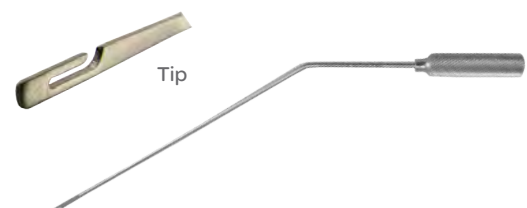



Scan the code above to learn more about our Rectal portfolio.

Rectal Portfolio



symmetry surgical™

Rectal

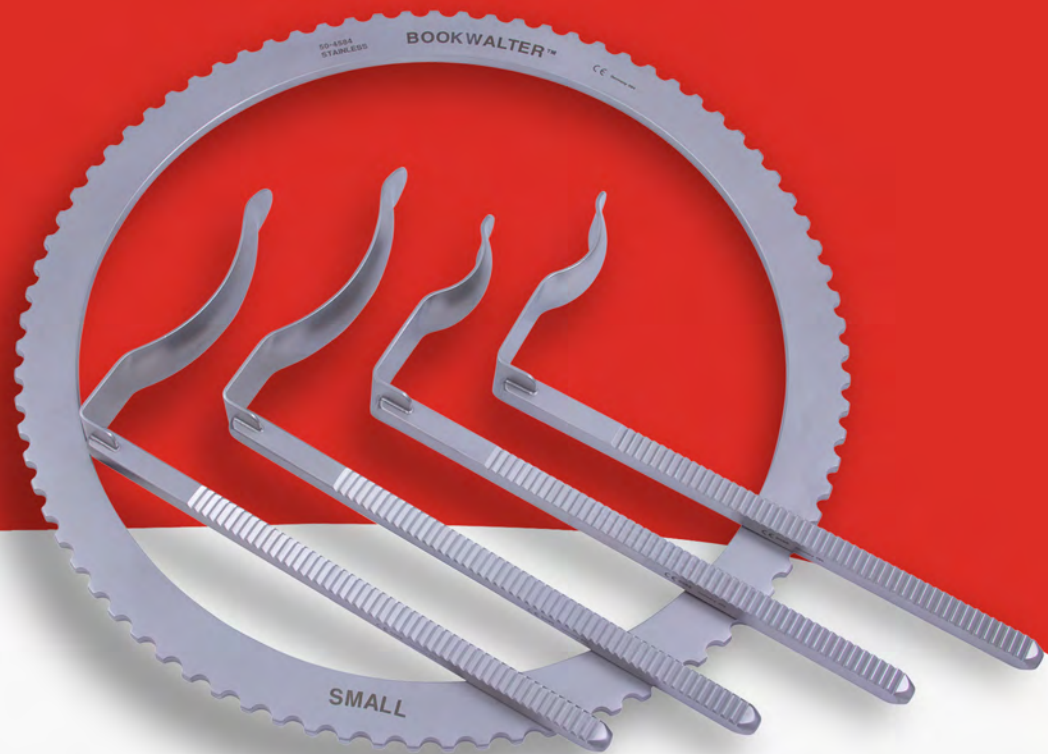

Forceps	REC-2
Hooks	REC-2
Ligators	REC-3
Probes	REC-3
Retractors	REC-4
Speculums	REC-7

Questions? Contact us at customerservice@symmetrysurgical.com or learn more at symmetrysurgical.com

 **symmetry surgical™**

The Surgical Instrument Desk Reference

How to Use Our Catalog

The Symmetry Surgical catalog is designed with you in mind, to be your trusted resource for surgical instrumentation. We took great care in creating an easy-to-use, robust catalog and we think you'll be pleased with the design as you become more familiar with our broad portfolio.

Layout

The catalog is organized by surgical specialty *and* product function.

And we know that it is difficult to pick up an instrument and know what specialty it's listed in. To make your job easier, we've sorted the instruments in our portfolio by surgical function, too, including Energy, Laparoscopic, Retractors and Sterilization Solutions.

U.S. Customer Service

Your Symmetry Surgical Customer Service team wants to make ordering surgical instruments the easiest part of your day. We accept orders via phone, fax, email, our website, Global Healthcare Exchange (GHX) and through the mail.

PHONE

800.251.3000

(Available Monday through Friday, 8:30 AM–6:30 PM EST)

FAX

800.342.3272

EMAIL

customerservice@symmetrysurgical.com

ONLINE

symmetrysurgical.com

MAILING ADDRESS

Symmetry Surgical
Attn: Customer Service
3034 Owen Drive
Antioch, TN 37013

The Surgical Instrument Desk Reference

International Customer Service

PHONE

Symmetry Surgical Switzerland GmbH
+41 (0) 52 557 59 00
(Available Monday through Friday, 7:00-16:00 GMT)

Symmetry Surgical, Inc., USA
615.964.5672
(Available Monday through Friday, 8:30 AM–6:30 PM EST)

FAX

Symmetry Surgical Switzerland GmbH
+41 (0) 52 557 59 99

EMAIL

customerservice@symmetrysurgical.com
internationalorders@symmetrysurgical.com

ONLINE

symmetrysurgical.com

MAILING ADDRESS

Symmetry Surgical Switzerland GmbH
Bühlstrasse 27
CH-8200 Schaffhausen
Switzerland

Symmetry Surgical, Inc.
3034 Owen Drive
Antioch, TN 37013

INTERNATIONAL PAYMENT TERMS/RETURN GOODS POLICY/INSTRUMENT REPAIR & RESTORE PROGRAM/LITERATURE REQUESTS

Please contact your local distributor. Locate a local distributor contact, International Customer Service at +41 (0) 52 557 59 00 or 615.964.5672 (US).

Cardiovascular/Thoracic

Energy

Ear, Nose & Throat

General

Laparoscopic

Neurology

Obesity

OB/GYN

Ophthalmology

Orthopedics & Arthroscopy

Pediatrics

Rectal

Retractors

Spine

Urology

Sterilization Solutions

Alphabetical & Numeric Indexes

RECTAL

Forceps (Biopsy)

Jackson Rectal Biopsy Forceps

CODE	DESCRIPTION	LENGTH
50-8135	1/8 x 1/4 in (4.0 x 6.0 mm) Bite	14 in 355 mm

Yeoman Rectal Biopsy Forceps

CODE	DESCRIPTION	LENGTH
50-8093	Square Basket	17 in 430 mm

Hooks (Crypt)

Stewart Crypt Hook

CODE	DESCRIPTION	LENGTH
50-9438	Short Style	8 1/2 in 215 mm
50-9439	Long Hook	9 in 230 mm

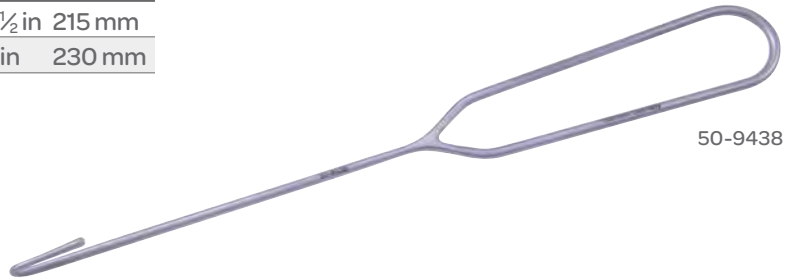

50-9438

Ligators (Hemorrhoidal)



McGivney Hemorrhoidal Ligator Set

CODE	DESCRIPTION	LENGTH
DX-8	Set Includes the Following:	
DX-8-8	Ligator Only	8 in 200 mm
DX-18	Grasping Forceps for DX-18	
DX-2	Ligator Cone (Drum)	

Probes (Fistula)

Barr Fistula Probe

CODE	DESCRIPTION	LENGTH
50-9409	Double-Ended	6 in 150 mm



Buie Fistula Probe

CODE	DESCRIPTION	LENGTH
50-9420	Sterling Silver	8 in 200 mm



Pratt Fistula Probe

CODE	DESCRIPTION	LENGTH
50-9441	Narrow	8 ¼ in 210 mm
50-9442	Short	8 ¼ in 210 mm
50-9443	Long	8 ¼ in 210 mm



Probes (Rectal)

Larry Rectal Probe

CODE	DESCRIPTION	LENGTH
50-9450	Sterling Silver, Malleable	7 in 175 mm



Pratt Rectal Probe

CODE	DESCRIPTION	LENGTH
50-9410	Sterling Silver, Malleable	8 in 200 mm



Retractors (Bookwalter®)

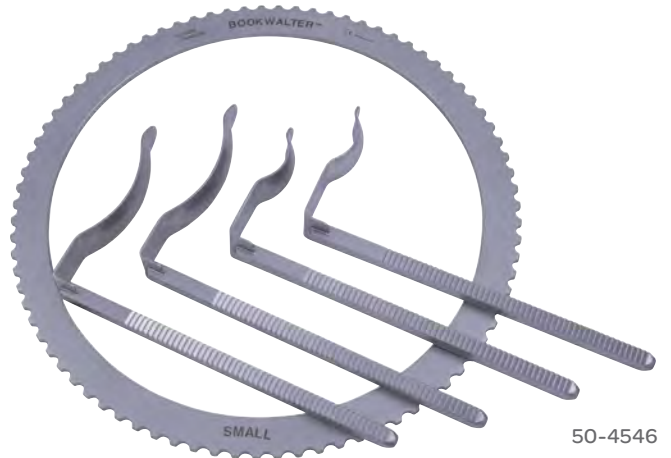

Bookwalter® Rectal Accessory Kit

Kit Includes: 1 Ring and 2 Blades

CODE	DESCRIPTION	DIAMETER	BLADE	DIMENSIONS
50-4546	Kit Includes the Following:			
50-4584	Bookwalter® Round Rings, Small	8 ½ in 216mm		
50-4585	Bookwalter® Rectal Blade, Small		2 7/8 in 73 mm	3 x 7 in 76 x 178 mm
50-4586	Bookwalter® Rectal Blade, Large		3 7/8 in 98 mm	4 x 6 in 101 x 152 mm

Note: Use of this product requires a Bookwalter® Table Post, Bookwalter® Coupler, Bookwalter® Horizontal Bar, and Bookwalter® Ratchet (not included in this accessory set.)

Retractors (Prostatic)



51-9503

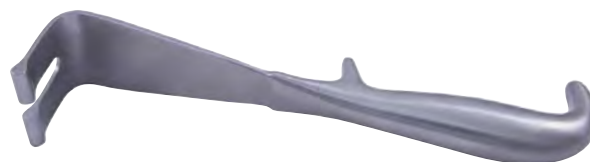

51-9504

Young Prostatic Retractor

CODE	DESCRIPTION	DIMENSIONS		LENGTH	
51-9501	Lateral Notched Blade	$\frac{7}{16} \times 2$ in	11 x 50 mm	8 $\frac{1}{4}$ in	210 mm
51-9503	Notched Blade	1 x 1 in	25 x 25 mm	8 $\frac{1}{4}$ in	210 mm
51-9504	Bifurcated Blade	1 $\frac{3}{4}$ x 1 $\frac{1}{2}$ in	44 x 38 mm	8 $\frac{1}{4}$ in	210 mm



Barr Anal Retractor

CODE	DESCRIPTION	DIMENSIONS		LENGTH	
50-7325	Self-Retaining with Blades	2 $\frac{3}{4}$ x $\frac{7}{8}$ in	70 x 22 mm	8 in	200 mm

Retractors (Rectal)



50-9604

Hill-Ferguson Rectal Retractor

CODE	DIMENSIONS		LENGTH	
50-9604	$\frac{7}{8} \times \frac{1}{4}$ in	22 x 6.0 mm	8 in	200 mm
50-9605	$\frac{1}{8} \times 3$ in	3.0 x 76 mm	8½ in	215 mm
50-9606	3 x $1\frac{3}{8}$ in	76 x 35 mm	8½ in	215 mm
50-9607	1½ in	38 mm	8½ in	215 mm



50-9621

Sawyer Retractor

CODE	DESCRIPTION	BLADE DIMENSIONS		LENGTH	
50-9621	Retractor	$1\frac{1}{8} \times 3$ in	28 x 76 mm	11 in	280 mm
50-9622	Retractor	$1\frac{1}{2} \times 3\frac{1}{2}$ in	38 x 89 mm	11 in	280 mm

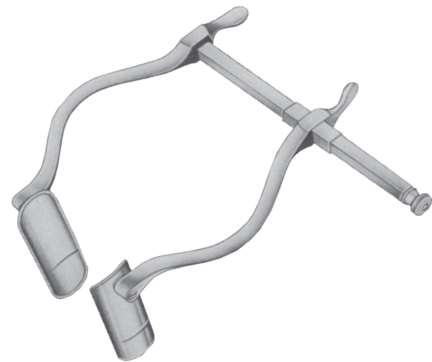

Smith-Buie Rectal Retractor

CODE	DESCRIPTION	LENGTH
50-7420	Self-Retaining, with Swivel Blades	4½ in 115 mm

Speculums (Operating)



Fansler Operating Speculum

CODE	DESCRIPTION	DIAMETER		LENGTH	
50-9610	Fenestrated Handle, Removable Obturator	1 $\frac{3}{8}$ in	35 mm	8 in	200 mm

Speculums (Rectal)



Brinkerhoff Rectal Speculum

CODE	DESCRIPTION	DIMENSIONS		LENGTH	
50-7615	Medium	$\frac{5}{8}$ x 1 in	16 x 25 mm	4 in	100 mm



50-9616

Chelsea-Eaton Anal Speculum

CODE	DESCRIPTION	DIAMETER	
50-9615	Fenestrated Handle, Removable Obturator	$\frac{7}{8}$ in	22 mm
50-9616	Fenestrated Handle, Removable Obturator	1 $\frac{1}{4}$ in	32 mm

Speculums (Rectal)



50-9601

Hinkle-James Rectal Speculum

CODE	DESCRIPTION	DIAMETER	
50-9601	Small	2 $\frac{1}{8}$ in	54 mm
50-9602	Medium	2 $\frac{1}{4}$ in	57 mm



50-7716

Hirschmann Rectal Speculum

CODE	DESCRIPTION	DIAMETER		LENGTH
50-7716	Small	$\frac{9}{16}$ in	14 mm	2 $\frac{3}{8}$ in 60 mm
50-7719	Medium	$\frac{11}{16}$ in	17 mm	2 $\frac{3}{4}$ in 70 mm



Pennington Rectal Speculum

CODE	DESCRIPTION	DIAMETER		LENGTH
50-9630	With Obturator, Long Handle, Chrome	1 in	25 mm	5 $\frac{1}{4}$ in 135 mm

Speculums (Rectal)



Pratt Rectal Speculum

CODE	DESCRIPTION	BLADE (W X D)	LENGTH
50-7320-H	Stainless Steel, with Set Screw	1 x 3 ³ / ₈ in 25 x 85 mm	8 ¹ / ₂ in 215 mm



Sims Rectal Speculum

CODE	DESCRIPTION	BLADE (W X D)	LENGTH
50-7300	With Solid Blade	1/2 x 3 in 13 x 76 mm	6 1/4 in 159 mm
50-7305	With Fenestrated Blade	1/2 x 3 in 13 x 76 mm	6 1/4 in 159 mm



Scan the code above to learn more about our Retractor portfolio.

Retractors Portfolio



symmetry surgical™

Retractors

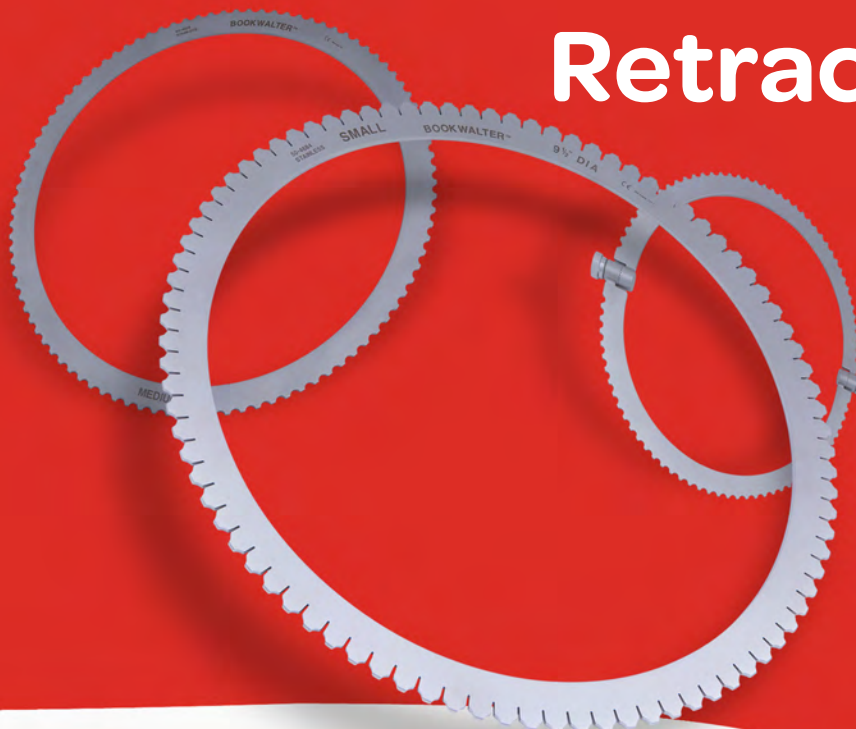

Abdominal Self-Retaining	RET-2	General Purpose Lighted	RET-62	Orthopaedic Shoulder	RET-97	Spine Karlin™	RET-125
Abdominal Bookwalter® Bars	RET-8	General Purpose Self-Retaining	RET-62	Plastic Surgery Brow Lift	RET-97	Spine Micro Discectomy	RET-126
Abdominal Bookwalter® Blades	RET-10	Hysterectomy	RET-71	Plastic Surgery Hand	RET-97	Spine McCulloch	RET-127
Abdominal Bookwalter® Kits	RET-14	Laparoscopic	RET-72	Plastic Surgery Hand-Held	RET-98	Spine Nerve Root	RET-132
Abdominal Kits	RET-21	Laparoscopic Bookwalter®	RET-73	Prostatic	RET-98	Spine Self-Retaining	RET-135
Abdominal Bookwalter® Ratchets	RET-22	Lung	RET-74	Rectal Hand-Held	RET-99	Spine Bookwalter®	RET-136
Abdominal Bookwalter® Rings	RET-24	Mastectomy	RET-74	Rectal Self-Retaining	RET-99	Kits - Anterior Cervical Fusion	RET-138
Abdominal Bookwalter® Table Posts	RET-27	Mouth Gags	RET-75	Rectal Bookwalter®	RET-100	Kits - Cervical Retractor	RET-141
Abdominal Universal Blades	RET-28	Neuro Flap	RET-75	Rectal	RET-100	Splanchnic	RET-143
Abdominal Vision	RET-31	Neuro Hand-Held	RET-76	Redundant Wall	RET-101	Sternal	RET-144
Appendectomy	RET-32	Neuro Lachrymal Sac	RET-76	Renal Sinus	RET-102	Thoracotomy	RET-146
Cardiac Aorta	RET-32	Neuro Posterior Fossa	RET-77	Renal Vein	RET-102	Thymus	RET-147
Cardiac Aorta Valves	RET-33	Neuro Self-Retaining	RET-78	Renal	RET-102	Thymus Hand-Held	RET-147
Cardiac Atrial	RET-33	Neuro Greenberg®	RET-79	Rib Self-Retaining	RET-103	Thyroid	RET-147
Cardiac Atrial Valves	RET-33	Neuro	RET-84	Rib	RET-103	Tonsil	RET-148
Cardiac Epicardial	RET-34	Ophthalmology Hand-Held	RET-85	Scalp	RET-105	Tracheal	RET-149
Cardiac Bookwalter®	RET-34	Ophthalmology Lens Capsule	RET-86	Scapula	RET-107	Uvula	RET-150
Carotid Self-Retaining	RET-36	Ophthalmology Lid	RET-86	Septum	RET-108	Vaginal Bookwalter®	RET-151
Cerebellar	RET-37	Ophthalmology Orbital	RET-87	Spine Crockard™	RET-108	Vaginal	RET-154
Cheek	RET-37	Ophthalmology Self-Retaining	RET-88	Spine Cervical	RET-111	Vascular	RET-157
Deltoid	RET-38	Orthopaedic Bones	RET-89	Spine Decompression	RET-117	Vascular Vision	RET-158
Endaural	RET-38	Ophthalmology Hand	RET-91	Spine Dural	RET-117	Vein	RET-159
ENT (Mastoid)	RET-39	Orthopaedic Hand-Held	RET-91	Spine Hand-Held	RET-119	Vessel	RET-159
ENT (Nasal)	RET-39	Orthopaedic Hip	RET-92	Spine Hand-Held Retractor Set	RET-120		
Fiber Optic	RET-40	Orthopaedic Hip and Shoulder	RET-92	Spine Hemilaminectomy	RET-121		
Gall Bladders	RET-41	Orthopaedic Humeral	RET-94	Spine Lamina	RET-122		
General Purpose Finger Retractors	RET-42	Orthopaedic Humeral Head	RET-95	Spine Laminectomy	RET-122		
General Purpose Hand-Held	RET-43	Orthopaedic Knee	RET-95	Spine Lumbar	RET-124		

Questions? Contact us at customerservice@symmetrysurgical.com or learn more at symmetrysurgical.com

The Surgical Instrument Desk Reference

How to Use Our Catalog

The Symmetry Surgical catalog is designed with you in mind, to be your trusted resource for surgical instrumentation. We took great care in creating an easy-to-use, robust catalog and we think you'll be pleased with the design as you become more familiar with our broad portfolio.

Layout

The catalog is organized by surgical specialty *and* product function.

And we know that it is difficult to pick up an instrument and know what specialty it's listed in. To make your job easier, we've sorted the instruments in our portfolio by surgical function, too, including Energy, Laparoscopic, Retractors and Sterilization Solutions.

U.S. Customer Service

Your Symmetry Surgical Customer Service team wants to make ordering surgical instruments the easiest part of your day. We accept orders via phone, fax, email, our website, Global Healthcare Exchange (GHX) and through the mail.

PHONE

800.251.3000

(Available Monday through Friday, 8:30 AM–6:30 PM EST)

FAX

800.342.3272

EMAIL

customerservice@symmetrysurgical.com

ONLINE

symmetrysurgical.com

MAILING ADDRESS

Symmetry Surgical
Attn: Customer Service
3034 Owen Drive
Antioch, TN 37013

The Surgical Instrument Desk Reference

International Customer Service

PHONE

Symmetry Surgical Switzerland GmbH
+41 (0) 52 557 59 00
(Available Monday through Friday, 7:00-16:00 GMT)

Symmetry Surgical, Inc., USA
615.964.5672
(Available Monday through Friday, 8:30 AM-6:30 PM EST)

FAX

Symmetry Surgical Switzerland GmbH
+41 (0) 52 557 59 99

EMAIL

customerservice@symmetrysurgical.com
internationalorders@symmetrysurgical.com

ONLINE

symmetrysurgical.com

MAILING ADDRESS

Symmetry Surgical Switzerland GmbH
Bühlstrasse 27
CH-8200 Schaffhausen
Switzerland

Symmetry Surgical, Inc.
3034 Owen Drive
Antioch, TN 37013

INTERNATIONAL PAYMENT TERMS/RETURN GOODS POLICY/INSTRUMENT REPAIR & RESTORE PROGRAM/LITERATURE REQUESTS

Please contact your local distributor. Locate a local distributor contact, International Customer Service at +41 (0) 52 557 59 00 or 615.964.5672 (US).

Cardiovascular/Thoracic

Energy

Ear, Nose & Throat

General

Laparoscopic

Neurology

Obesity

OB/GYN

Ophthalmology

Orthopedics & Arthroscopy

Pediatrics

Rectal

Retractors

Spine

Urology

Sterilization Solutions

Alphabetical & Numeric Indexes

Abdominal (Self-Retaining)

Balfour Abdominal Retractor

CODE	DIMENSIONS
24-5200AAA	16 x 2½ x 3½ in 406 x 63 x 89 mm



Balfour Abdominal Retractor

CODE	DESCRIPTION	DIMENSIONS
24-5200A	Includes: Two Pairs Lateral Snap-On Wire Blades, Left Hand Assembly Provided Unless Specified Otherwise.	16 x 2½ x 3½ in 406 x 63 x 89 mm

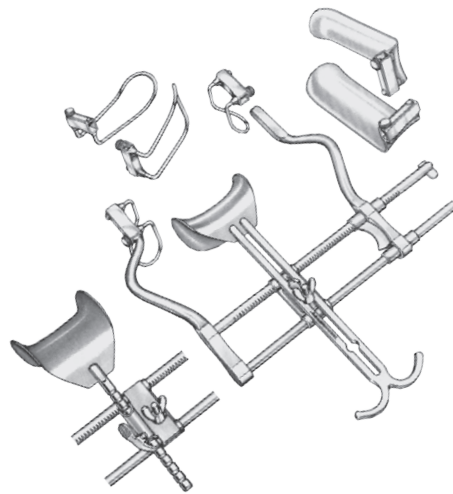

Balfour Abdominal Retractor

CODE	DESCRIPTION	DIMENSIONS
24-5200AA	Includes: Two Pairs Lateral Snap-On Wire Blades, One Center Blade (Chosen From: 24-5012, 24-5014, 24-5022, 24-5024, 24-5026, 50-2428, 24-5030, 24-5032, 24-5034 or 24-5036). Left Hand Assembly Provided Unless Specified Otherwise.	16 x 2½ x 3½ in 406 x 63 x 89 mm

Abdominal (Self-Retaining)



Balfour Abdominal Retractor

CODE	DESCRIPTION	DIMENSIONS	WIDTH	LENGTH
24-5200-1	Includes: Two Pairs Lateral Snap-On Wire Blades, One Center Blade (Left Hand Assembly Provided Unless Specified Otherwise)	8 1/2 x 2 1/2 x 3 1/2 in	216 x 63 x 89 mm	
24-5012			2 1/2 in 63 mm	1 3/4 in 44 mm
24-5014			3 5/8 in 92 mm	1 3/4 in 44 mm
24-5022			2 3/4 in 69 mm	2 5/8 in 66 mm
24-5024			3 3/8 in 85 mm	2 3/4 in 69 mm
24-5026			1 5/8 in 41 mm	2 5/8 in 66 mm
50-2428			1 5/8 in 41 mm	3 1/2 in 88 mm
24-5030			2 1/2 in 63 mm	2 5/8 in 66 mm
24-5032			2 1/2 in 63 mm	3 1/2 in 88 mm
24-5034			2 in 50 mm	6 1/2 in 165 mm
24-5036			2 1/2 in 63 mm	6 1/2 in 165 mm

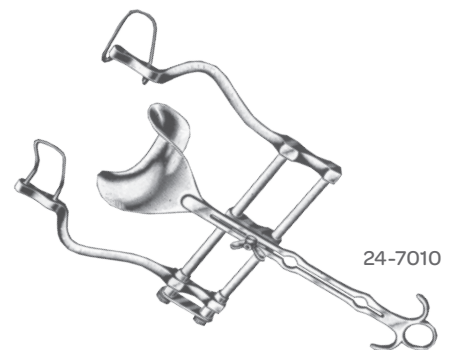

Balfour Abdominal Retractor

Standard Model with Fenestrated Blades 2 1/2 in (64 mm) Deep with Center Blade 24-7072 3 x 2 in (76 x 51 mm)

CODE	MAX SPREAD	DIMENSIONS
24-7010	7 1/8 in 181 mm	2 1/2 x 3 1/2 in 63 x 89 mm
24-7020	10 in 254 mm	

Abdominal (Self-Retaining)

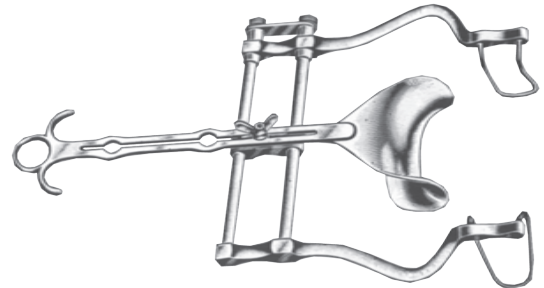

24-7020

Balfour Abdominal Retractor

Standard Model: Fenestrated Blades 4 in (102 mm) Deep, with Center Blade 24-7073

CODE	MAX SPREAD
24-7073	3 ³ / ₈ x 2 ¹ / ₂ in 86 x 64 mm
24-7015	7 ¹ / ₈ in 181 mm
24-7017	10 in 254 mm



Balfour Abdominal Retractor

CODE	DESCRIPTION	DIMENSIONS (WxD)	LENGTH
50-4516	Center Blade, Standard	3 ¹ / ₂ x 1 ³ / ₄ in 89 x 45 mm	9 ³ / ₄ in 248 mm

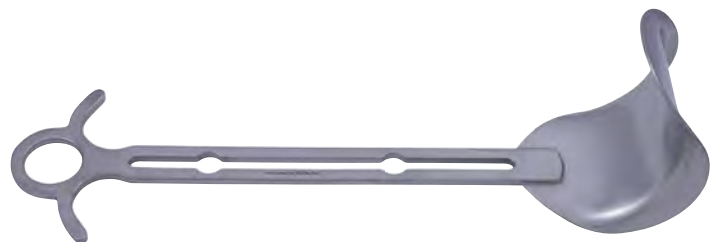

50-4521

Balfour Abdominal Retractor

CODE	DESCRIPTION	DIMENSIONS (WxD)	DIMENSIONS
50-4521	Center Blade, Supra-Pubic	2 ³ / ₄ x 2 ³ / ₄ in 70 x 70 mm	9 ¹ / ₂ in 241 mm
50-4522	Center Blade, Supra-Pubic	3 ¹ / ₄ x 2 ³ / ₄ in 83 x 70 mm	9 ³ / ₄ in 248 mm

Abdominal (Self-Retaining)



50-4504

Balfour Abdominal Retractor

Fenestrated Lateral Blade, One Pair

CODE	DESCRIPTION	BLADE DEPTH
50-4504	Use with 50-4503 and 50-4509	2½ in 64 mm
50-4505	Use with 50-4503 and 50-4509	3½ in 89 mm
50-4506	Use with 50-4503 and 50-4509	4 in 102 mm
24-5201	Wire Lateral Blades for Use with 24-5200 Series	2½ in 64 mm
24-5203	Wire Blades for Use with 24-5200 Series	4 in 101 mm
24-5202	Solid Lateral Blades for Use with 24-5200 Series	2½ in 64 mm
24-5204	Solid Lateral Blades for Use with 24-5200 Series	4 in 101 mm



50-4527

Balfour Abdominal Retractor

Fourth Arm Attachment

CODE	DESCRIPTION	DIMENSIONS
50-4527	Without Blade, Right	12 in 305 mm
50-4526	Without Blade, Left	12 in 305 mm



Balfour Abdominal Retractor

CODE	DESCRIPTION	DIMENSIONS
50-5651	Miniature Model, Self-Retaining with Fixed Lateral Fenestrated Blades 1 x 1 in (25 x 25 mm) and One Center Blade 1 x 1 in (25 x 25 mm), Maximum Spread 3¾ in (95 mm).	3½ x 3¾ in 89 x 95 mm

Abdominal (Self-Retaining)



Balfour Fenestrated Retractor

With Two Lateral Blades and One Center Blade

CODE	TOTAL OPENING	LATERAL BLADE (W X D)	CENTER BLADE (W X D)
50-4500	7 in 178 mm	1¼ x 2 in 32 x 51 mm	3 x 2 in 76 x 51 mm



Balfour Retractor Complete

Self-Retaining with Ratchet Crossbar

CODE	COMPLETE TOTAL OPENING	LATERAL BLADES (W X D)	CENTER BLADE (W X D)
50-4514	7 in 178 mm	1½ x 2¼ in 38 x 57 mm 1½ x 3¼ in 38 x 83 mm	3¼ x 2¼ in 83 x 57 mm 2½ x 2½ in 64 x 64 mm



Horgan Abdominal Retractor

CODE	DESCRIPTION	DIMENSIONS
50-4524	Malleable Center Blade	14¾ in 375 mm



Wing Nut

CODE	DESCRIPTION
24-7002	Wing Nut

Abdominal (Self-Retaining)



Balfour Retractor with Fenestrated Blades

Abdominal Retractor, Self-Retaining with Trigger Ratchet. Includes Two Pair of Detachable Lateral Fenestrated Blades and One Center Blade

CODE	TOTAL OPENING	LATERAL BLADES (W X D)	CENTER BLADE (W X D)	TOTAL WIDTH
50-4503	7 ⁵ / ₈ in 194 mm	1 ³ / ₄ x 2 ¹ / ₂ in 44 x 64 mm	2 ¹ / ₂ x 2 ¹ / ₂ in 64 x 64 mm	7 ⁵ / ₈ 194 mm
		1 ³ / ₄ x 3 ³ / ₈ in 44 x 86 mm		

Also Available in a 10¹/₂ in Diameter. Part number: 50-4509.



Balfour Retractor with Fenestrated Blades

Abdominal Retractor, Self-Retaining. With Two Fixed Blades, Two Removable Small Blades and One Large Removable Blade

CODE	TOTAL OPENING	LATERAL BLADE (W X D)	CENTER BLADE (W X D)
50-4510	8 ¹ / ₂ in 216 mm	1 ¹ / ₂ x 2 ¹ / ₂ in 38 x 64 mm	2 ¹ / ₂ x 2 ¹ / ₂ in 64 x 64 mm

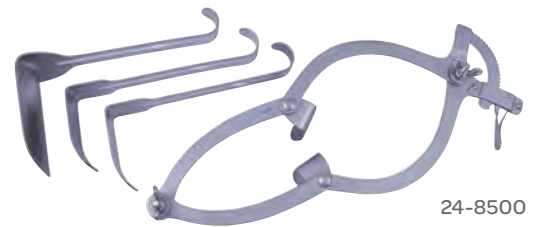

24-8500

O'Connor-O'Sullivan Abdominal Retractor

CODE	DESCRIPTION	LENGTH
24-8500	Complete Set (24-8509, 24-8511, 24-8512)	
24-8509	Frame Only, with 2 Rotatable Lateral Blades Attached	1 x 2 ¹ / ₃ in 25 x 60 mm
24-8511	Center Blade, 2/Each Included in 24-8500	1 ³ / ₄ x 3 ¹ / ₄ in 44 x 83 mm
24-8512	Center Blade, 1/Each Included in 24-8500	2 ³ / ₄ x 4 ¹ / ₈ in 70 x 105 mm
24-8599	Wing Nuts (Pair)	

Abdominal (Bookwalter® Bars)

Bookwalter® Violi Gooseneck Table Post

CODE	DESCRIPTION
50-4681	Table Post for 1 in (25 mm) System



Bookwalter® Lightweight Horizontal Bar

CODE	DESCRIPTION	LENGTH
50-4552	Horizontal Bar	14¼ in 362 mm

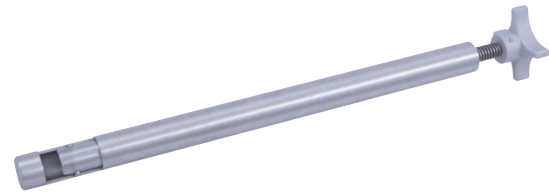

Bookwalter® Lightweight Horizontal Flex Bar

CODE	DESCRIPTION
50-4582	Lightweight Horizontal Flex Bar

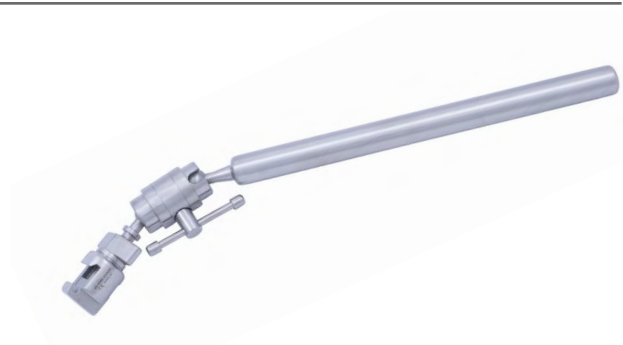

Bookwalter® Ironman Horizontal

CODE	DESCRIPTION
50-4678	Violi Ironman Horizontal Ring Holder



Abdominal (Bookwalter® Bars)

Bookwalter® Lightweight Horizontal Bar

CODE	DESCRIPTION	LENGTH
50-4618	Horizontal Bar	15¼in 387 mm

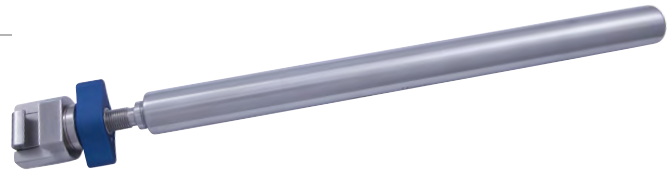

Bookwalter® Lightweight Extension Bar

Requires the Use of a Second Bookwalter® Post Coupler 50-4554

CODE	DIMENSIONS
50-4553	12 in 305 mm
50-4797	18 in 458 mm



50-4553

Bookwalter® Balfour Blade

CODE	DIMENSIONS
50-4576	2¾ x 3in 70 x 76 mm
BW1271017	3½ x 2¾ in 89 x 70 mm



50-4576

Bookwalter® Gelpi Blade

CODE	DIMENSIONS
50-4577	1 x 5 in 25 x 127 mm



Abdominal (Bookwalter® Blades)



50-4566

Bookwalter® Harrington Blade

CODE	DIMENSIONS
50-4566	2½ x 5⅝ in 63 x 143 mm
BW1045176	3½ x 10 in 89 x 254 mm



50-4568

Bookwalter® Kelly Blade

CODE	DESCRIPTION	WIDTH	DEPTH
50-4574	Kelly Blade	1 in 25 mm	1 in 25 mm
50-4575	Kelly Blade	1 in 25 mm	2½ in 64 mm
50-4565	Kelly Blade	2 in 51 mm	1½ in 38 mm
50-4563	Kelly Blade	2 in 51 mm	2 in 51 mm
50-4572	Kelly Blade	2 in 51 mm	2½ in 64 mm
50-4568	Kelly Blade	2 in 51 mm	3 in 76 mm
50-4569	Kelly Blade	2 in 51 mm	4 in 102 mm
50-4570	Kelly Blade	2 in 51 mm	5 in 127 mm
50-4571	Kelly Blade	2 in 51 mm	6 in 152 mm
BW1045000	Kelly Blade	2 in 51 mm	8 in 203 mm

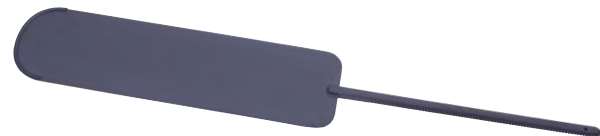

67-7499

Bookwalter® Opti-Length® Retractor Blade

Malleable with Lip

CODE	DIMENSIONS
67-7502	1½ x 11 in 38 x 279 mm
67-7504	2 x 11 in 51 x 279 mm
67-7499	3 x 11 in 76 x 279 mm
67-7500	4 x 11 in 102 x 279 mm

Abdominal (Bookwalter® Blades)



50-4644

Bookwalter® Rake Retractor

CODE	DESCRIPTION	WIDTH	DEPTH
50-4644	3 Prong	$\frac{2}{3}$ in 17 mm	$\frac{3}{4}$ in 19 mm
50-4645	4 Prong	$\frac{3}{4}$ in 19 mm	$\frac{1}{3}$ in 8.4 mm
50-4646	6 Prong	1 in 25 mm	$\frac{1}{3}$ in 8.4 mm



50-4598

Bookwalter® Richardson Blade

CODE	DIMENSIONS
50-4597	$\frac{3}{4}$ x 1 in 19 x 25 mm
50-4598	$\frac{3}{4}$ x 2 in 19 x 51 mm
50-4599	1 x 1 $\frac{1}{4}$ in 25 x 32 mm

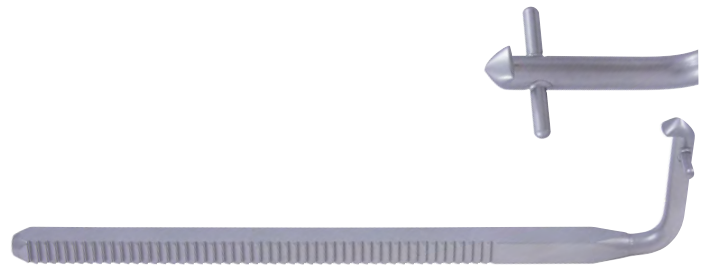

50-4639

Bookwalter® Scoville Hook

CODE	DESCRIPTION	DIMENSIONS
50-4639	Small	2 in 51 mm
50-4640	Large	3 $\frac{1}{4}$ in 83 mm

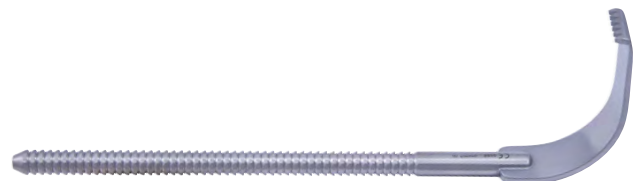

50-4641

Bookwalter®-Meyerding Retractor Blade

CODE	DESCRIPTION	DIMENSIONS
50-4641	Small	$\frac{2}{3}$ x 2 $\frac{1}{3}$ in 17 x 60 mm
50-4642	Medium	1 x 3 $\frac{1}{3}$ in 25 x 85 mm
50-4643	Large	2 x 3 $\frac{3}{4}$ in 51 x 95 mm

Abdominal (Bookwalter® Blades)



50-4561

Bookwalter® Malleable Retractor Blade

Stainless Steel Matte Finish

CODE	WIDTH X LENGTH
50-4561	2 x 6 in 51 x 152 mm
50-4562	1½ x 6 in 38 x 152 mm
50-4567	3 x 6 in 76 x 152 mm
BW1043016	2 x 10 in 51 x 254 mm
BW1043029	3 x 10 in 76 x 254 mm
BW1045069	4 x 8 in 101 x 203 mm



50-4673

Bookwalter® Retractor Blade

Malleable with Lip

CODE	DESCRIPTION	DIMENSIONS
50-4673	Small	2 x 6 in 51 x 152 mm
50-4672	Medium	1½ x 6 in 38 x 152 mm



50-4694

Bookwalter® Retractor Blade

Malleable with Lip

CODE	DESCRIPTION	DIMENSIONS
50-4694	Short	1 x 4 in 25 x 102 mm
50-4674	Large	3 x 6 in 76 x 152 mm



50-4669

Bookwalter® Retractor Blade

Super Malleable with Lip

CODE	DESCRIPTION	DIMENSIONS
50-4669	Small	1½ x 6 in 38 x 152 mm
50-4670	Medium	2 x 6 in 51 x 152 mm
50-4671	Large	3 x 6 in 76 x 152 mm

Abdominal (Bookwalter® Blades)



Bookwalter® -Magrina Retractor Blade

CODE	DESCRIPTION	DIMENSIONS
50-4691	Super Malleable with Lip	1 x 4 in 25 x 102 mm



50-5580

Bookwalter® Radiolucent Titanium Blade

Low Glare Gold Coating

CODE	DESCRIPTION	DIMENSIONS (W X L)	CODE	DESCRIPTION	DIMENSIONS (W X L)
50-5580	Titanium Blade	1 x 4 in 25 x 102 mm	50-5585	Titanium Blade	2 x 4 in 51 x 102 mm
50-5581	Titanium Blade	1 x 5 in 25 x 127 mm	50-5586	Titanium Blade	2 x 5 in 51 x 127 mm
50-5582	Titanium Blade	1 x 6 in 25 x 152 mm	50-5587	Titanium Blade	2 x 6 in 51 x 152 mm
50-5583	Titanium Blade	1 x 7 in 25 x 178 mm	50-5588	Titanium Blade	2 x 7 in 51 x 178 mm
50-5584	Titanium Blade	1 x 8 in 25 x 203 mm	50-5589	Titanium Blade	2 x 8 in 51 x 203 mm



Bookwalter® Lightweight Post Coupling

CODE	DESCRIPTION
50-4554	For a 1 in (25 mm) System

Abdominal (Bookwalter® Kits)

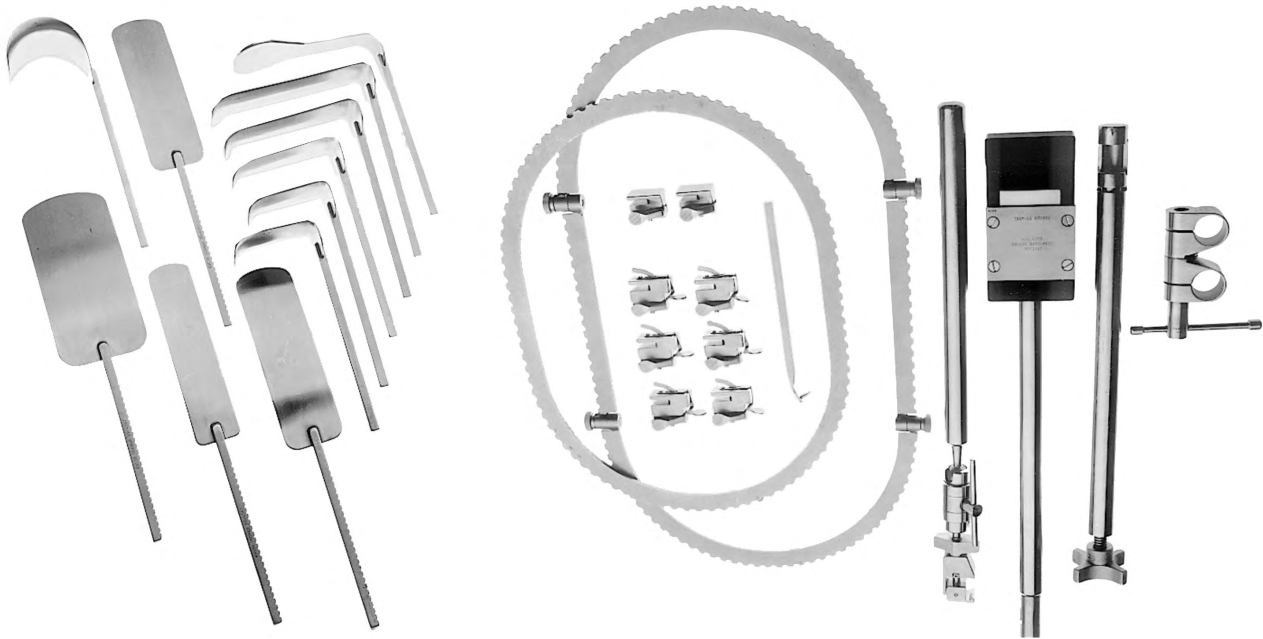

Bookwalter® Retractor Kit II

CODE	DESCRIPTION	LENGTH		QTY
50-4542	Includes Part Numbers and Quantities Listed Below:			
50-4581	Table Post	12 in	304 mm	1
50-4554	Post Coupling			1
50-4552	Horizontal Bar	14 ¼ in	365 mm	1
50-4582	Horizontal Flex Bar			1
50-4557	Medium Oval Ring			1
50-4583	Segmented Ring			1
50-4579	Ratchet Mechanisms			2
50-4580	Tilt Ratchet Mechanisms			6
50-4566	Harrington Retractors			1
50-4576	Balfour Retractors			1
50-4568	Kelly Retractors	2 x 3 in	51 x 76 mm	2
50-4569	Kelly Retractors	2 x 4 in	51 x 102 mm	1
50-4570	Kelly Retractors	2 x 5 in	51 x 127 mm	1
50-4571	Kelly Retractors	2 x 6 in	51 x 152 mm	1
50-4562	Malleable Retractors	1 ½ x 6 in	38 x 152 mm	1
50-4561	Malleable Retractors	2 x 6 in	51 x 152 mm	2
50-4567	Malleable Retractors	3 x 6 in	76 x 152 mm	1
50-4577	Gelpi Retractor			1
ACCESSORIES				
50-4507	Table Fixation and Ring Case			1
50-4508	Blade and Accessories Case			1

Abdominal (Bookwalter® Kits)

Bookwalter® Retractor Kit III

CODE	NAME	QTY
50-5710	Bookwalter® Retractor Kit III Includes Following Items:	
50-4688	Bookwalter® Lightweight Table Post, 12 in	1
50-4554	Bookwalter® Post Coupler,	1
50-4582	Bookwalter® Lightweight Horizontal Flex Bar	1
50-4583	Bookwalter® Medium Segmented Ring	1
50-4636	Bookwalter® Straight Ring Segment, 4 in, Pair	1
50-4580	Bookwalter® Tilting Ratchet	4
50-4686	Bookwalter® Self-Retaining Tilting Ratchet	4
50-4568	Bookwalter® 2x3 Kelly Retractor Blade	2
50-4569	Bookwalter® 2x4 Kelly Retractor Blade	2
50-4570	Bookwalter® 2x5 Kelly Retractor Blade	1
50-4571	Bookwalter® 2x6 Kelly Retractor Blade	1
50-4566	Bookwalter® Harrington Retractor Blade	1
50-4577	Bookwalter® Balfour Retractor	1
50-4672	Bookwalter® 1½x6 Malleable Retractor Blade	1
50-4673	Bookwalter® 2x6 Malleable Retractor Blade	2
50-4674	Bookwalter® 3x6 Malleable Retractor Blade	1
BW033015	Bookwalter® Twister Ratchet	1

Abdominal (Bookwalter® Kits)

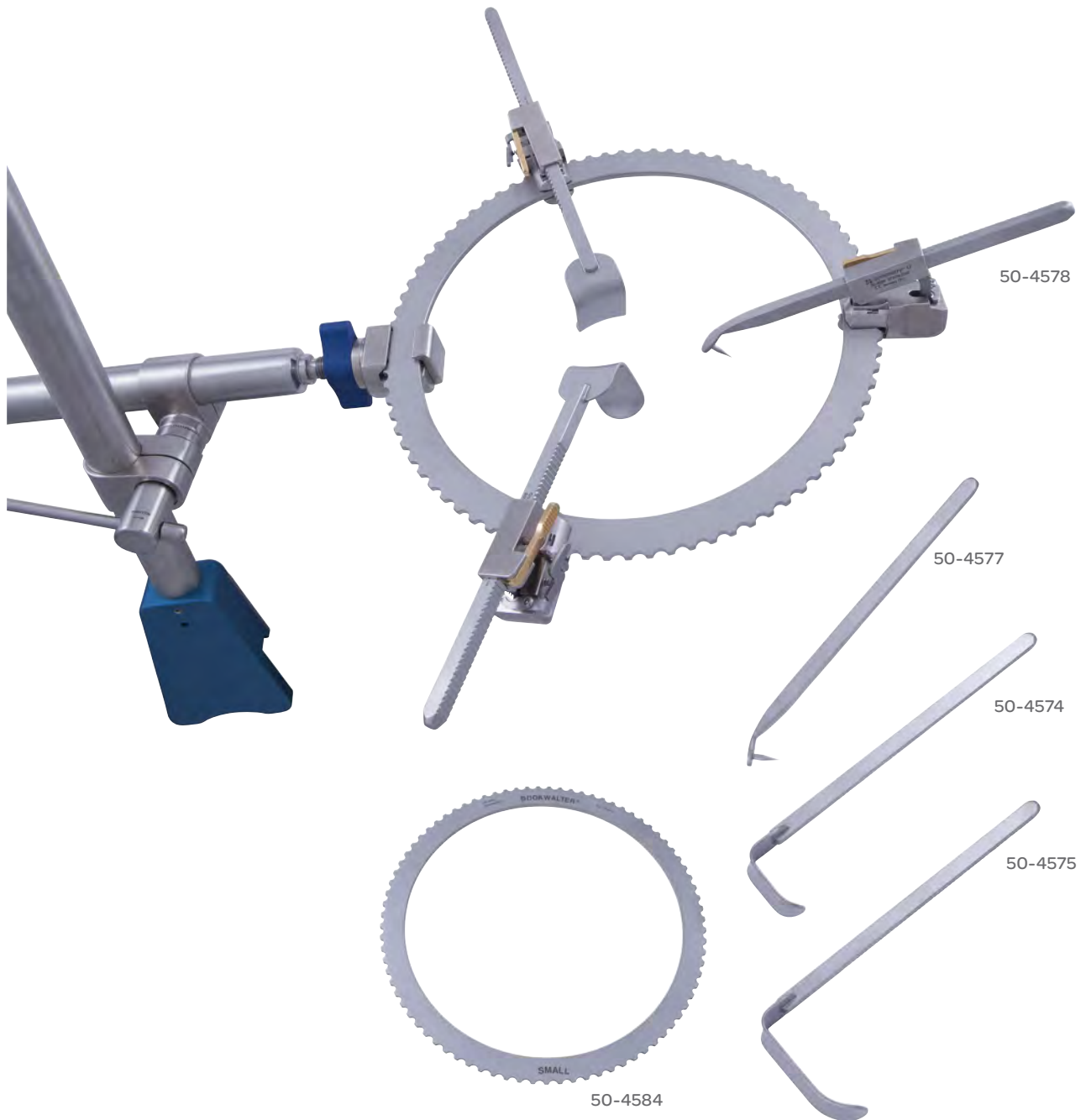

Bookwalter® Small Incision Kit

CODE	DESCRIPTION	LENGTH
50-4578	Includes Part Numbers Listed Below:	
50-4584	Round Ring	8½ in 216 mm
50-4577	Retractor Gelpi Blade	
50-4574	Kelly Retractor Blades	1x1½ in 25x38 mm
50-4575	Kelly Blade	1x2½ in 25x64 mm

Abdominal (Bookwalter® Kits)

Bookwalter® III Obese Patient Kit

CODE	NAME	QTY
50-5720	Bookwalter® III Obese Patient Kit Includes Following Items:	
50-4697	Bookwalter® Lightweight Table Post, 16 in	1
50-4554	Bookwalter® Post Coupling	2
50-4553	Bookwalter® Lightweight Extension Bar, 12 in	1
50-4618	Bookwalter® Lightweight Horizontal Bar	1
50-4588	Bookwalter® Large Segmented Ring	1
50-4636	Bookwalter® Straight Ring Segment, 4 in, Pair	1
50-4637	Bookwalter® Straight Ring Segment, 6 in, Pair	1
50-4580	Bookwalter® Tilting Ratchet	4
50-4686	Bookwalter® Self-Retaining Tilting Ratchet	6
50-4571	Bookwalter® 2x6 Kelly Retractor Blade	2
BW1045000	Bookwalter® 2x8 Kelly Retractor Blade	2
BW1045176	Bookwalter® Harrington Retractor Blade	1
BW1271017	Bookwalter® Balfour Retractor	1
67-7502	Bookwalter® 1½ x 11 Opti-Length® Malleable Retractor Blade with Malleable Lip	1
67-7504	Bookwalter® 2 x 11 Opti-Length® Malleable Retractor Blade with Malleable Lip	1
67-7499	Bookwalter® 3 x 11 Opti-Length® Malleable Retractor Blade with Malleable Lip	1
67-7500	Bookwalter® 4 x 11 Opti-Length® Malleable Retractor Blade with Malleable Lip	1
BW0338014	Bookwalter® Ratchet Extender	2
BW0338015	Bookwalter® Twister Ratchet	1

Abdominal (Bookwalter® Kits)

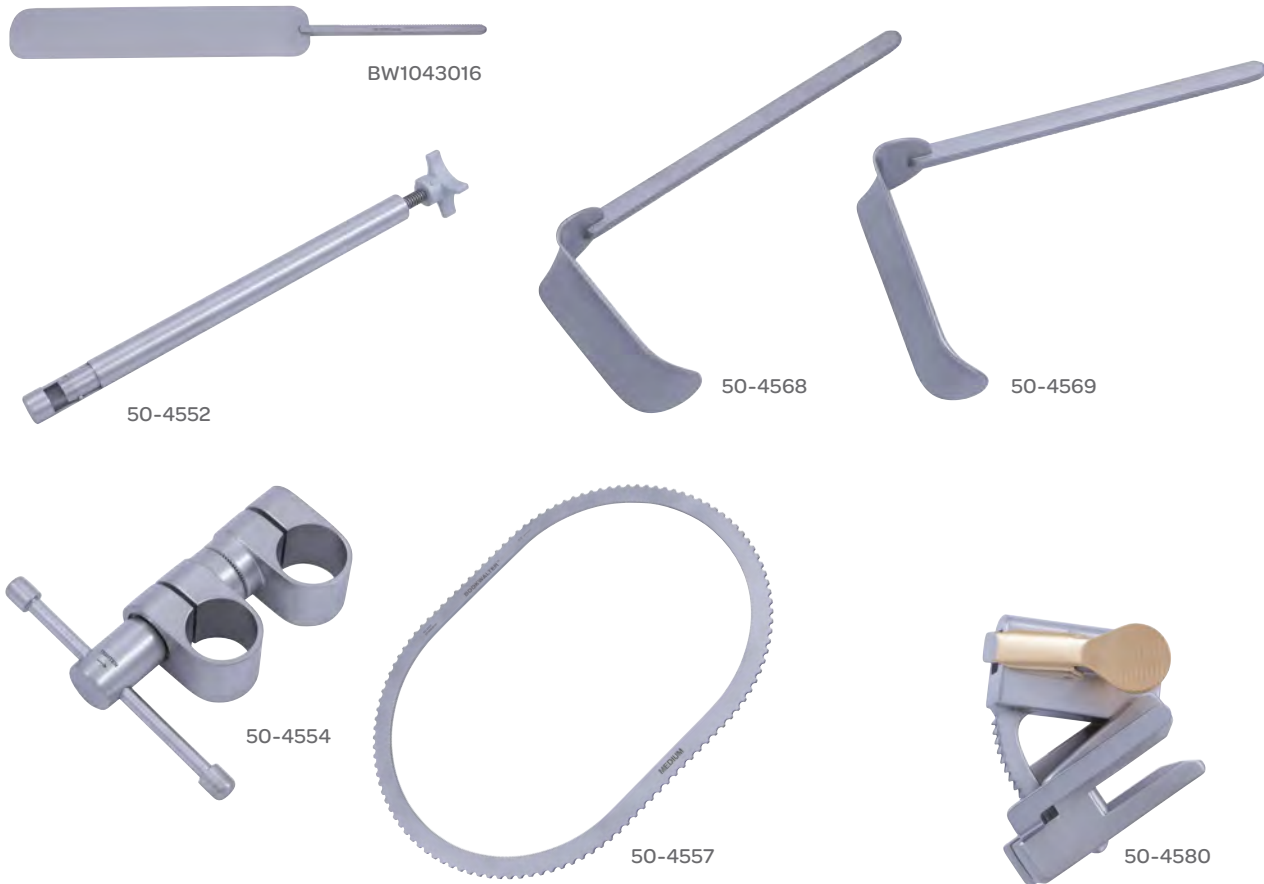

Bookwalter® Obese Patient Retractor System, 18 Inch (458 mm) Table Post

CODE	DESCRIPTION	DIMENSIONS		QTY
BW1046BKIT	Includes Part Numbers Listed Below:			
BW0144005	Table Post Obese Patients	18 in	458 mm	1
BW1043016	Malleable Blade	2 x 10 in	51 x 254 mm	1
BW1043029	Malleable Blade	3 x 10 in	76 x 254 mm	1
BW1045069	Malleable Blade	4 x 8 in	102 x 203 mm	1
BW1045000	Kelly Blade	2 x 8 in	51 x 203 mm	1
BW1271017	Balfour Blade	3½ x 2¾ in	89 x 70 mm	1
BW1045176	Harrington Blade	3½ x 10 in	89 x 254 mm	1
BW0338014	Ratchet Extender			1
BW0338015	Twister Ratchet			1
50-4552	Horizontal Bar	14¼ in	365 mm	1
50-4554	Post Coupling	1 x 1 in	25 x 25 mm	1
50-4557	Retractor, Oval Ring Medium			1
50-4568	Kelly Retractor Blades	2 x 3 in	51 x 76 mm	1
50-4569	Kelly Retractor Blades	2 x 4 in	51 x 102 mm	1
50-4580	Tilting Ratchets			6

Abdominal (Bookwalter® Kits)



Bookwalter® Obese Patient Accessory Kit, 18 Inch (458 mm) Table Post

CODE	DESCRIPTION	DIMENSIONS		QTY
BW1046BRT	Includes Part Numbers Listed Below:			
BW0144005	Table Post			1
BW1043016	Malleable Blade	2 x 10 in	51 x 254 mm	1
BW1043029	Malleable Blade	3 x 10 in	76 x 254 mm	1
BW1045069	Malleable Blade	4 x 8 in	102 x 203 mm	1
BW1045000	Kelly Blade	2 x 8 in	51 x 203 mm	1
BW1271017	Balfour Blade	3½ x 2¾ in	89 x 70 mm	1
BW1045176	Harrington Blade	3½ x 10 in	89 x 254 mm	1
BW0338014	Ratchet Extender			1
BW0338015	Twister Ratchet			1



Bookwalter® Obese Patient Accessory Kit, 24 Inch (610 mm) Table Post

CODE	DESCRIPTION	DIMENSIONS		QTY
BW1045BRT	Includes Part Numbers Listed Below:			
BW0144003	Table Post	24 in	610 mm	1
BW1043016	Malleable Blade	2 x 10 in	51 x 254 mm	1
BW1043029	Malleable Blade	3 x 10 in	76 x 254 mm	1
BW1045069	Malleable Blade	4 x 8 in	102 x 203 mm	1
BW1045000	Kelly Blade	2 x 8 in	51 x 203 mm	1
BW1271017	Balfour Blade	3½ x 2¾ in	89 x 70 mm	1
BW1045176	Harrington Blade	3½ x 10 in	89 x 254 mm	1
BW0338014	Ratchet Extender			1
BW0338015	Twister Ratchet			1

Abdominal (Bookwalter® Kits)



Bookwalter® Obese Patient Retractor System, 24 Inch (610 mm) Table Post

CODE	DESCRIPTION	LENGTH		QTY
BW1045BKIT	Includes Part Numbers Listed Below:			
BW0144003	Table Post	24 in	610 mm	1
BW1043016	Malleable Blade	2 x 10 in	51 x 254 mm	1
BW1043029	Malleable Blade	3 x 10 in	76 x 254 mm	1
BW1045069	Malleable Blade	4 x 8 in	102 x 203 mm	1
BW1045000	Kelly Blade	2 x 8 in	51 x 203 mm	1
BW1271017	Balfour Blade	3½ x 2¾ in	89 x 70 mm	1
BW1045176	Harrington Blade	3½ x 10 in	89 x 254 mm	1
BW0338014	Ratchet Extender			1
BW0338015	Twister Ratchet			1
50-4552	Horizontal Bar	14¼ in	365 mm	1
50-4554	Post Coupling	1 x 1 in	25 x 25 mm	1
50-4557	Medium Oval Ring			1
50-4568	Kelly Blade	2 x 3 in	51 x 76 mm	1
50-4569	Kelly Blade	2 x 4 in	51 x 102 mm	1
50-4580	Tilt Ratchets			6



Bookwalter® Richardson Blade Kit

CODE	DESCRIPTION	LENGTH	
50-4596	Includes One of the Following Three Blades:		
50-4597	Blade	¾ x 1 in	19 x 25 mm
50-4598	Blade	¾ x 2 in	19 x 51 mm
50-4599	Blade	1 x 1¼ in	25 x 32 mm

Abdominal (Kits)

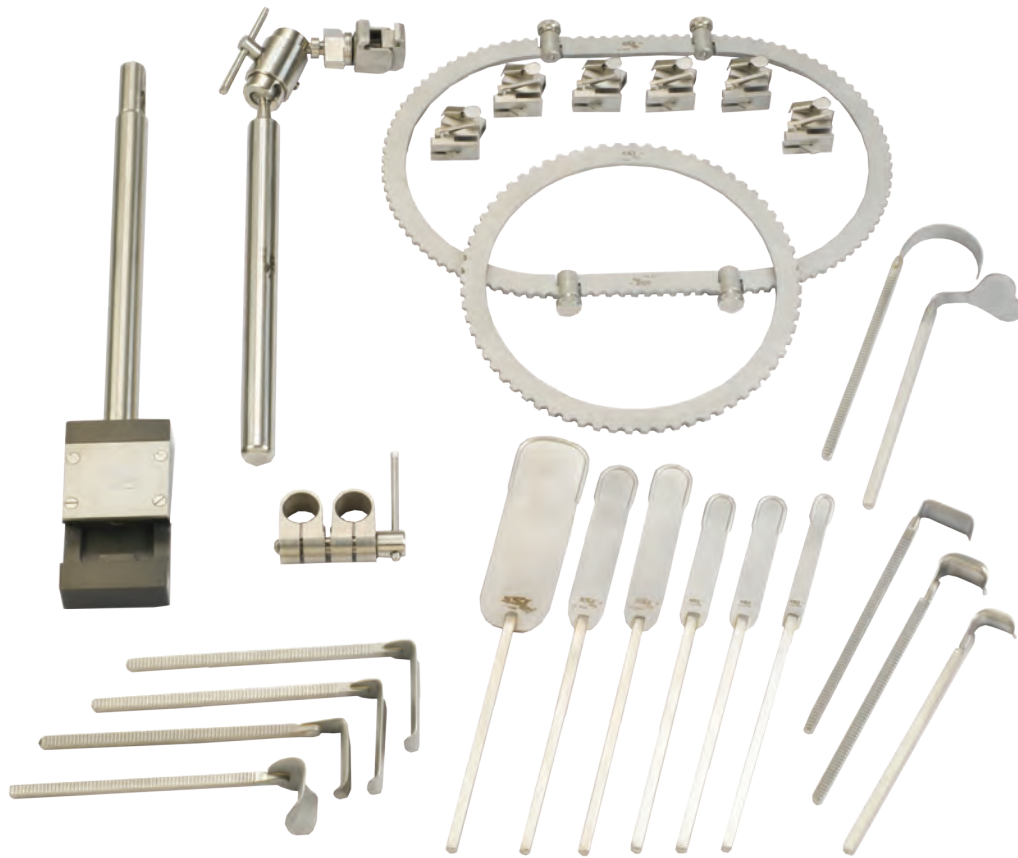

Universal Ring Pediatric System

CODE	DESCRIPTION	LENGTH	QUANTITY
58-0145	Ring Pediatric System		
58-0001	12 in (305 mm) Table Post		1
58-0003	Post Coupling		1
58-0005	Horizontal Flex Bar		1
58-0065	Tilt Ratchets		6
58-0062	Small Round Ring		1
58-0058S	Small Segmented Ring		1
58-4501	Richardson Blade	$\frac{3}{4}$ x 1 in	1
58-4502	Richardson Blade	$\frac{3}{4}$ x $1\frac{1}{4}$ in	1
58-0029	Kelly Blade	1 x $1\frac{1}{2}$ in	1
58-0027	Kelly Blade	2 x $1\frac{1}{2}$ in	1
58-0009	Kelly Blade	1 x 3 in	2
58-0044	Malleable Blade	2 x 6 in	1
58-0041	Malleable Blade	$\frac{1}{2}$ x 4 in	2
58-0042	Malleable Blade	1 x 5 in	2
58-0040	Malleable Blade	$\frac{3}{4}$ x 4 in	1
58-0036	Baby Harrington	$\frac{1}{2}$ x $2\frac{1}{2}$ x 2 in	1
58-0103	Deaver Blade	$\frac{2}{3}$ x $2\frac{1}{4}$ in	1

Abdominal (Bookwalter® Ratchets)

Bookwalter® Flat Ratchet

CODE	DESCRIPTION	QTY
50-4579	Basic Ratchet provides simple retraction at 0° angle to the surgical site.	1/ Each Sold Individually



Bookwalter® Tilt Ratchet

CODE	DESCRIPTION	QTY
50-4580	Tilt ratchet articulates the blade into the surgical site.	1/ Each Sold Individually



Bookwalter Rotilt® Ratchet

CODE	DESCRIPTION	QTY
50-4589	The Rotilt Ratchet twists the blade in 7 indexed positions along a 60° arch and has the ability to independently articulate the blade into the surgical site.	1/ Each Sold Individually



Abdominal (Bookwalter® Ratchets)

Bookwalter® Self-Retaining Low Profile Locking Rotilt Ratchet

CODE	DESCRIPTION	QTY
504695	Self-Retaining Low Profile Locking Rotilt	1/ Each Sold Individually



Bookwalter® Self-Retaining Tilt Ratchet

CODE	DESCRIPTION	QTY
50-4686	Like the 50-4580 this ratchet articulates the blade into the surgical site, it also has an additional self-retention latch that holds the ratchet onto the Bookwalter® Retractor Ring.	1/ Each Sold Individually



Bookwalter® Self-Retaining Low Profile Locking Rotilt Ratchet

CODE	DESCRIPTION	QTY
50-4696	The Bookwalter® Self-Retaining Low Profile Locking RoTilt Ratchet bring all of the best features of all other ratchets into one mechanism. The low profile design, inclusive of the capacity to tilt, rotate and self-retention it is the one ratchet to build your Bookwalter® Set.	1/ Each Sold Individually



Bookwalter® Twister Ratchet

CODE	DESCRIPTION	QTY
BW0338015	Twister Ratchet	1/ Each Sold Individually



Abdominal (Bookwalter® Ratchets)

Bookwalter® Ratchet Extender



CODE	DESCRIPTION
BW0338014	Ratchet Extender

Abdominal (Bookwalter® Rings)



504810

Bookwalter® Adaptable Ring System

Table Mounted

CODE	DESCRIPTION
50-4810	System Includes the Horizontal Bar and Dual Ball Joint Hinge System as well as the Small Round, Medium Round and Medium Oval Ring Segments.
50-4811	Small Round Ring Segments
50-4812	Medium Round Ring Segments
50-4813	Medium Oval Ring Segments

Bookwalter® Adaptable Ring System Bridge



CODE	DESCRIPTION
50-4687	For use with 50-4810

Bookwalter® Segmented Elliptical Ring



CODE	DESCRIPTION	DIMENSIONS	
50-4595	Elliptical Ring	14 ½ x 15 in	368 x 380 mm

Abdominal (Bookwalter® Rings)

Bookwalter® Oval Ring

CODE	DESCRIPTION	DIMENSIONS	
50-4558	Small	8 x 12¼ in	203 x 311 mm
50-4557	Medium	10½ x 14½ in	267 x 368 mm
50-4556	Large	12 x 18½ in	305 x 470 mm



50-4558

Bookwalter® Round Ring

Table Mounted

CODE	DESCRIPTION	DIAMETER	
50-4584	Small	8½ in	216 mm
50-4559	Medium	10½ in	267 mm
50-4560	Large	12½ in	318 mm



50-4559

Bookwalter® Suture Ring

CODE	DESCRIPTION	DIAMETER	
50-4684	Small, Round	9½ in	241 mm



Bookwalter® Round Ring Segmented

CODE	DESCRIPTION	DIAMETER	
50-4635	Small, 1 Pair	8½ in	216 mm
50-4634	Medium, 1 Pair	10½ in	267 mm
50-4633	Large, with Suture Slots	16 in	406 mm



50-4635

Abdominal (Bookwalter® Rings)



50-4587

Bookwalter® Segmented Retractor Ring

CODE	DESCRIPTION	DIMENSIONS
50-4587	Small, Consists of One 8 ½ in Round Ring and Two 4 in Straight Segments	8 ½ x 14 in 216 x 356 mm
50-4583	Medium, Consists of One 10 ½ in Round Ring and Two 8 in Straight Segments	10 ½ x 19 ½ in 267 x 495 mm
50-4588	Large, Consists of One 12 ½ in Round Ring and Two 6 in Straight Segments	12 ½ x 19 ½ in 318 x 495 mm

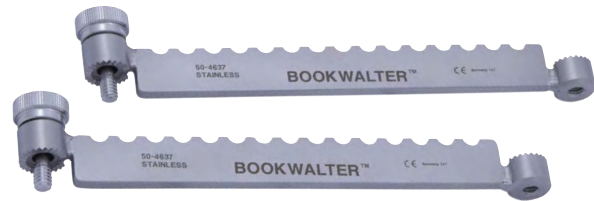

50-4637

Bookwalter® Segmented Ring (Straight Segments)

CODE	DESCRIPTION	LENGTH
50-4636	Straight Ring Segment (Pair)	4 in 102 mm
50-4637	Straight Ring Segment (Pair)	6 in 152 mm
50-4638	Straight Ring Segment (Pair)	8 in 203 mm

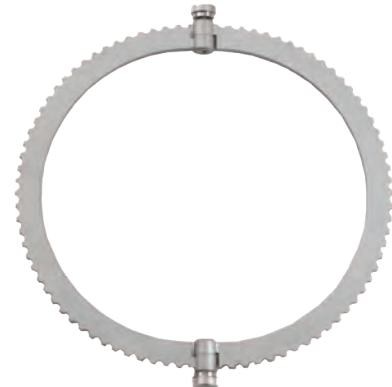

Bookwalter® Universal Ring Segmented Ring Screw

CODE	DESCRIPTION	LENGTH
58-0093X	Screw Only, One Each	15/16 in 24 mm

Abdominal (Bookwalter® Table Posts)



Bookwalter® Post Holder

CODE	DESCRIPTION	LENGTH
50-4680	For Use with the Gooseneck 50-4681	4 in 102 mm



Bookwalter® Table Post

CODE	LENGTH
50-4581	12 in 304 mm

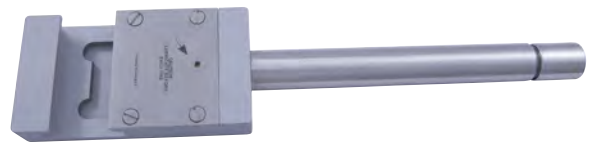

Bookwalter® Table Post

CODE	LENGTH
50-4683	8 in 203 mm

Bookwalter® Table Post

CODE	LENGTH
BW0144003	24 in 608 mm



Bookwalter® Table Post

CODE	LENGTH
BW0144005	18 in 457 mm

Abdominal (Bookwalter® Table Posts)

Bookwalter® Lightweight Table Post

CODE	LENGTH	
50-4688	12 in	304 mm
50-4697	16 in	406 mm



504688

Abdominal (Universal Blades)

Universal Ring Big Boy Retractor Blade

CODE	DESCRIPTION	LENGTH
58-0020	Fenestrated	2 x 6 ½ in
58-0021	Fenestrated	3 x 6 ½ in



58-0021

Universal Ring Deaver Retractor Blade

CODE	DESCRIPTION	DIMENSIONS	
58-0103		1 x 3 ½ in	25 x 89 mm
58-0104		1 x 5 in	25 x 127 mm
58-0102		2 x 6 ½ in	51 x 165 mm
58-0104T	Titanium	2/3 x 2 ¼ in	16.9 x 57 mm
58-0103T	Titanium	1 x 5 in	25 x 127 mm
58-0101T	Titanium	2 x 3 ½ in	51 x 89 mm
58-0102T	Titanium	3 x 6 ½ in	76 x 165 mm



58-101T

Universal Ring Harrington Retractor Blade

CODE	DIMENSIONS	
58-0035	2/3 x 2 ¼ in	16.9 x 57 mm
58-0037	3 x 10 ½ in	76 x 267 mm



58-0035

Abdominal (Universal Blades)

Universal Ring Kelly Retractor Blade

CODE	DESCRIPTION	DIMENSIONS	
58-0025		1 x 3 in	51 x 76 mm
58-0018A	Aluminum	2 x 5 in	51 x 127 mm
58-0016A	Aluminum	2 x 6 in	51 x 152 mm
58-0032A	Aluminum	2 x 6 in	51 x 152 mm
58-0009		2½ x 5 x 3½ in	64 x 127 x 89 mm
58-0017T	Titanium	2½ x 8 x 3½ in	64 x 203 x 89 mm
58-0016T	Titanium	3 x 10½ in	76 x 267 mm

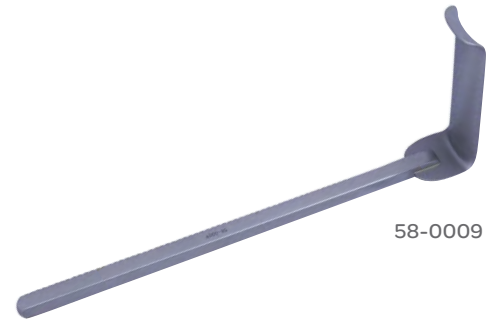

58-0009

Universal Ring Meyering Retractor Blade

Without Teeth

CODE	DESCRIPTION	DIMENSIONS	
58-0048T	Titanium	2 x 4 in	51 x 102 mm
58-0051T	Titanium	2½ x 3 in	64 x 76 mm



58-0048T

Universal Ring Pediatric Harrington Retractor Blade

CODE	DESCRIPTION	DIMENSIONS	
58-0036	Ring Pediatric Harrington Retractor Blade	2 x 8 in	51 x 203 mm

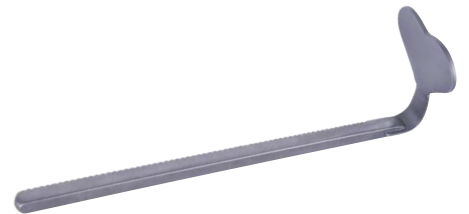

Universal Ring Retractor Blade

CODE	DESCRIPTION	DIMENSIONS	
58-0073	Fence, Rigid	2 x 3¾ in	51 x 95 mm
58-0044T	Titanium	3½ x 3¾ in	89 x 95 mm

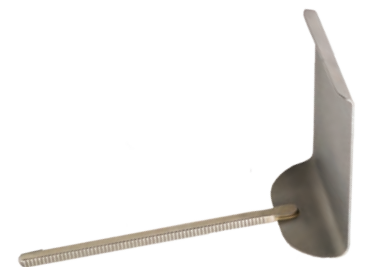

58-0073

Abdominal (Universal Blades)

Universal Ring Scoville Retractor Blade

CODE	DESCRIPTION
58-0106	Large

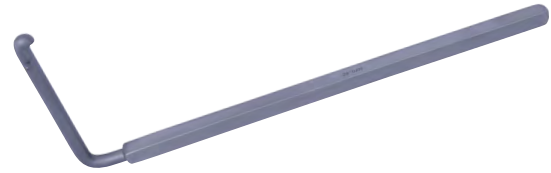

Universal Ring Yu-Holtgrew Retractor Blade

CODE	DESCRIPTION	DIMENSIONS
58-0022	Rigid	4 x 5 in 102 x 127 mm

Universal Ring Retractor Blade

CODE	DESCRIPTION	LENGTH
58-0042	Malleable, With Lip	1 x 5 in 25 x 127 mm
58-0045	Malleable, With Lip	2 x 8 in 51 x 203 mm
58-0049	Malleable, With Lip	1 x 5 in 25 x 127 mm
58-0054	Malleable, With Lip	6 x 9 in 152 x 228 mm
58-0056	Malleable, With Lip	4 x 10 in 102 x 254 mm



Universal Ring Retractor Blade

CODE	DESCRIPTION	LENGTH
58-0057N	Malleable, No Lip	6 x 9 in 152 x 229 mm
58-0044N	Malleable, No Lip	6 x 12 in 152 x 305 mm

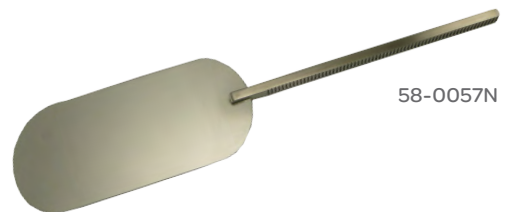

Abdominal (Vision)

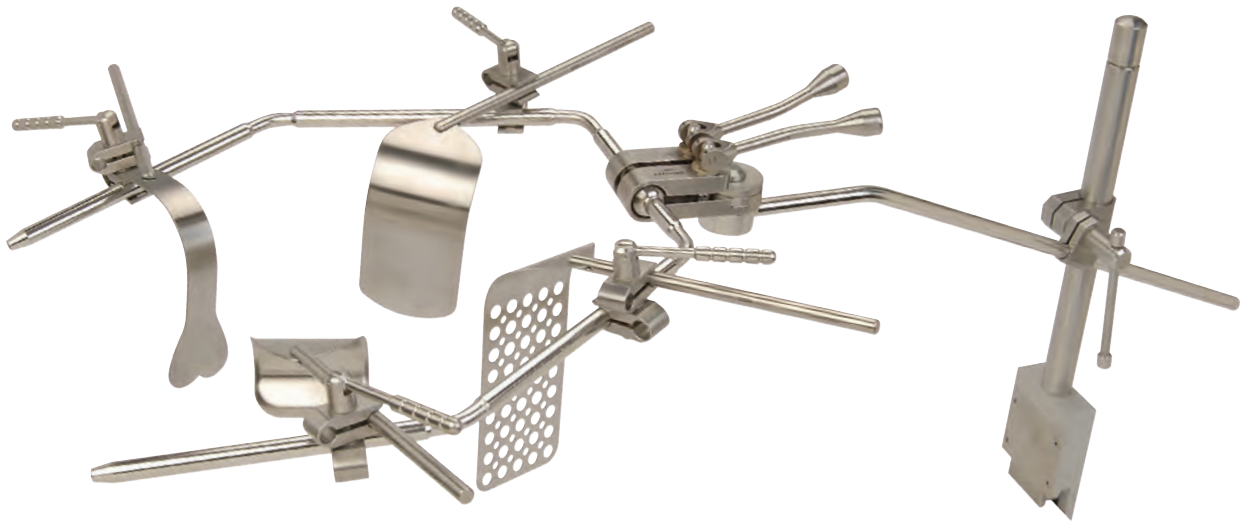

Vision Retractor System

CODE	DESCRIPTION	DIMENSIONS		QTY
59-8850	Includes the Following Items:			
59-8802	Table Clamp with Vertical Post			1
59-8803	Retractor Clamp			6
59-8805	Vision Frame			1
59-8807	Mayo Swivel	2 3/4 x 2 in	70 x 51 mm	2
59-8809	Deaver Swivel	2 3/4 x 4 1/2 in	70 x 114 mm	1
59-8811	Harrington "Sweetheart"	2 x 5 in	51 x 127 mm	1
59-8813	Kelly Swivel "Modified"	3 x 2 1/2 in	76 x 64 mm	1
59-8814	Kelly Swivel "Modified"	3 x 4 in	76 x 102 mm	1
59-8815	Malleable Swivel, Perforated	2 x 6 in	51 x 152 mm	1
59-8816	Malleable Swivel, Perforated	3 x 6 1/2 in	76 x 165 mm	1
59-8818	Fence Swivel, Perforated	4 x 6 in	102 x 152 mm	1
59-8821	Splanchnic Swivel	2 x 6 in	51 x 152 mm	1
59-8801	Post Coupling			1
59-8828	Sterilization Case			1

Symmetry Surgical Instrument Repair Services

KEY BENEFITS:

- Full instrument restoration
- 24-Hour turnaround for emergency repairs are available by request, but must be scheduled with our repair department and noted on the repair request form
- Free quotes
- Free evaluations

Questions about requesting a repair? Send it to repairs@symmetrysurgical.com. Our Repair Centers honor the warranties on all of our products. Customer satisfaction is our top priority!

Appendectomy



Richardson Appendectomy Retractor

CODE	DESCRIPTION	DIMENSIONS (W X D)	LENGTH
50-4131	Ring-Grip Handle	$\frac{3}{4}$ x 2 in 19 x 51 mm	9 $\frac{1}{4}$ in 235 mm



Richardson Appendectomy Retractor

CODE	DESCRIPTION	DIMENSIONS (W X D)	LENGTH
50-4130C	Standard Handle	$1\frac{3}{16}$ x 2 in 20 x 51 mm	9 $\frac{1}{4}$ in 235 mm



Rigby Appendectomy Retractor

CODE	DESCRIPTION	LENGTH
24-4218	Appendectomy Retractor	7 $\frac{1}{2}$ in 190mm

Cardiac (Aorta)



Crawford Aorta Retractor

55-8008

CODE	DESCRIPTION	LENGTH
55-8008	Small	7 $\frac{1}{2}$ in 191 mm
55-8009	Large	12 in 305 mm

Cardiac (Aortic Valves)



Liddicoat Aortic Valve Retractor

50-8012

CODE	DESCRIPTION	LENGTH
50-8011	Small	9½ in 241 mm
50-8012	Large	9½ in 241 mm

Cardiac (Atrial)



50-8006

Cooley Atrial Retractor

CODE	DESCRIPTION	LENGTH
50-8006	Right	10 in 254 mm
50-8005	Left	12 in 305 mm



Cooley Atrial Retractor

CODE	DESCRIPTION	DIMENSIONS
50-8007	Modified with Teeth	1¾ x 1¾ in 44 x 44 mm

Cardiac (Atrial Valves)



50-8005

Cooley Atrial Valve Retractor

CODE	DESCRIPTION	DIMENSIONS (W X D)
55-8005	Left	2 x ¾ in 50 x 10 mm
55-8001	Right, Small	1 x ¾ in 25 x 20 mm
55-8002	Right, Medium	1 ⅝ x 1 ⅛ in 40 x 30 mm
55-8003	Right, Large	2 x 1 ⅜ in 50 x 35 mm

Cardiac (Epicardial)

I.M.A. Epicardial Retractor (Gold Coated)

CODE	DESCRIPTION	LENGTH	
80-1864	Mini	1 in	25 mm
80-1861	Small	1 $\frac{1}{8}$ in	28 mm
80-1862	Medium	1 $\frac{1}{2}$ in	38 mm
80-1863	Large	2 $\frac{1}{8}$ in	54 mm

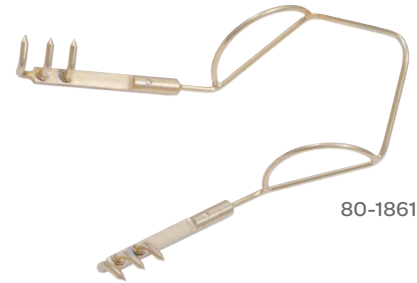

80-1861

Parsonnet Epicardial Retractor

3 x 3 Prong, Sharp

CODE	DESCRIPTION	LENGTH	
37-4035	Self-Retaining, Light Spring Steel	1 $\frac{1}{2}$ in	38 mm
55-5750	Small	1 $\frac{1}{8}$ in	29 mm
55-5751	Medium	1 $\frac{1}{16}$ in	37 mm
55-5752	Large	1 $\frac{1}{8}$ in	47 mm

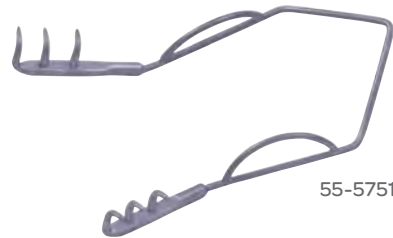

55-5751

Cardiac (Bookwalter®)

Bookwalter® I.M.A. Crossbar

CODE	DESCRIPTION	DIMENSIONS	
50-4601	Small	1 $\frac{1}{8}$ in	29 mm
50-4675	"T" bar for Use with the BW I.M.A. Kit 50-4600		



50-4675

Bookwalter® I.M.A. Retractor Blade

CODE	DESCRIPTION	LENGTH	
50-4603	I.M.A Retractor Blade	12 in	304 mm



Cardiac (Bookwalter®)

Bookwalter® I.M.A. Retractor Storage Case

CODE	DESCRIPTION
50-4604	I.M.A. Retractor Storage Case



Bookwalter® I.M.A. Ratchet

CODE	DESCRIPTION
50-4602	I.M.A. Ratchet



Bookwalter® I.M.A. Retractor System

Provides the Tools to Elevate and Retract the Sternum for Efficient Dissection of the Internal Mammary Art

CODE	DESCRIPTION	LENGTH	QTY
50-4600	Includes Part Numbers Listed Below:		
50-4552	Horizontal Bar	14 ¼ in 365 mm	1
50-4554	Coupler	1 x 1 in 25 x 25 mm	1
50-4581	Table Post	12 in 305 mm	1
50-4601	I.M.A. Cross Bar	12 in 305 mm	1
50-4602	I.M.A. Ratchet		2
50-4603	I.M.A. Rake Retractor, Sharp		2
50-4604	I.M.A. Retractor Case		1



Carotid (Self-Retaining)



55-9050

Henly Carotid Retractor

Modified Weitlaner with Three Center Blades

CODE	DESCRIPTION	DIMENSIONS (D X W)	
55-9050	Complete Set		
55-9051	6½ in Long		
55-9052	Small Blade For 55-9050	¾ x ⅝ in	19 x 16 mm
55-9053	Medium Blade for 55-9050	1 x ⅝ in	25 x 16 mm
55-9054	Large Blade for 55-9050	1¼ x ⅝ in	32 x 16 mm



Henly Self-Retaining Carotid Retractor

CODE	DESCRIPTION	DIMENSIONS (D X W)	
55-8999	Set with 3 Removable Side Blades and 3 Removable Center Blades		
55-8999A	Frame Only for 55-8999, 2⅜ in 61 mm Spread	¾ x ⅝ in	19 x 16 mm
55-8999-1	Side Blade	1 x ⅞ in	25 x 23 mm
55-8999-2	Side Blade	2 x ⅞ in	51 x 23 mm
55-8999-3	Side Blade	3 x ⅞ in	76 x 23 mm
55-8999-4		¾ x ⅝ in	19 x 16 mm
55-8999-5		1 x ⅝ in	25 x 16 mm
55-8999-6		1¼ x ⅝ in	31 x 16 mm
55-8999-7		3 x ⅝ in	76 x 16 mm
55-8999-8		2 x ⅝ in	51 x 16 mm

Cerebellar

Adson Cerebellar Retractor

Length: 7 ³/₄ in (197 mm)

CODE	DESCRIPTION	PRONGS
24-2801	Straight Arms	4 x 4, Sharp
24-2803	Straight Arms	4 x 4, Sharp
50-1180	Straight Shaft	4 x 4, Sharp
50-1182	Straight Shaft	4 x 4, Sharp
24-2802	Angled Arms	4 x 4, Sharp
50-1181	Angular Shaft	4 x 4, Sharp
50-1362	65° Shank Angle	4 x 4, Sharp

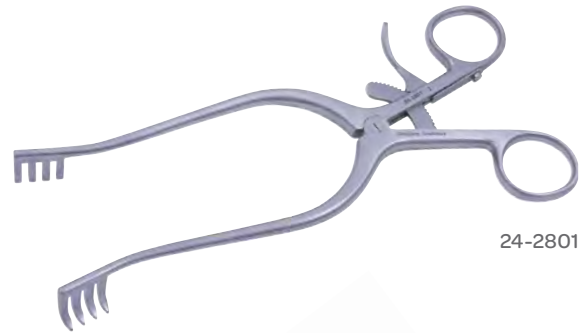

24-2801

Malis® Cerebellar Retractor

CODE	DESCRIPTION	PRONGS	DIMENSIONS	
50-1465	Self Retaining, Angular Arms	4 x 4, Sharp	7 ¹ / ₂ in	191 mm



Miskimon Cerebellar Retractor

Sharp

CODE	DESCRIPTION	PRONGS	LENGTH	
50-1363		7 x 7	7 ¹ / ₂ in	191 mm
24-2810	Angled Arms	7 x 7	8 ³ / ₄ in	222 mm

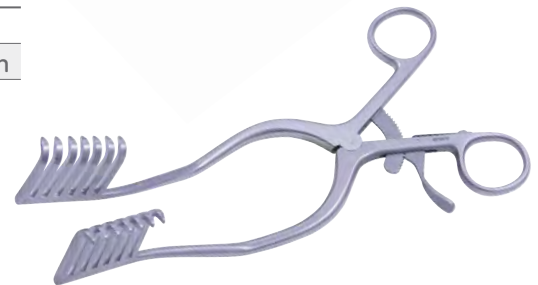

Cheek

Cheek Retractor

CODE	DESCRIPTION	DIMENSIONS (W X L)	
72-0240	With Swivel	1 ¹¹ / ₁₆ x 8 ³ / ₁₆ in	43 x 209 mm



Deltoid



Deltoid Retractor

CODE	DESCRIPTION	BLADE	LENGTH
77-1015	Brown Deltoid Retractor	2 ³ / ₈ x 2 ⁹ / ₁₆ in 60 x 65 mm	10 ⁷ / ₈ in 275 mm

Endaural



Endaural Retractor

CODE	DESCRIPTION
61-0601	T Model

Snitman Endaural Retractor



CODE	DESCRIPTION	PRONGS	LENGTH
50-1236	Self-Retaining	⁹ / ₁₆ x ³ / ₈ 14 x 10 mm	4 ³ / ₁₆ in 106 mm

ENT(Mastoid)

Miskimon Cerebellar Retractor

7 x 7 Prongs, Sharp, Angled Arms

CODE	BLADE DEPTH	LENGTH
24-2810	1¼ in 32 mm	8¾ in 222 mm

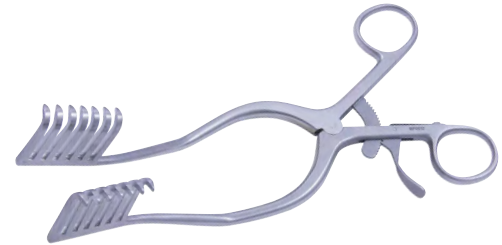

ENT(Nasal)

Aufricht Nasal Retractor

CODE	LENGTH
67-2136	7⅞ in 182 mm
67-2135	7½ in 191 mm



Converse Nasal Retractor

CODE	LENGTH
63-4022	4¾ in 112 mm



Cottle Nasal Retractor

CODE	PRONGS	LENGTH
67-2044	4, Blunt	5⅞ in 130 mm

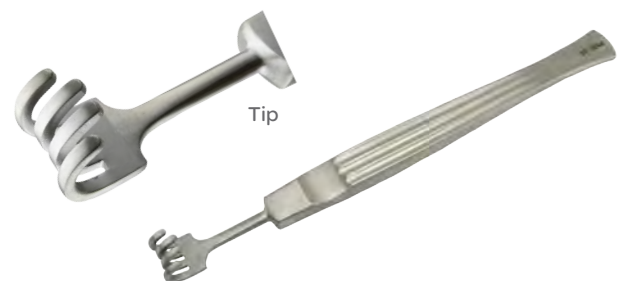

ENT (Nasal)



Halle Nasal Speculum

CODE	BLADE LENGTH	TOTAL LENGTH
79-6669	1 ¼ in 32 mm	6 in 152 mm



Vienna Nasal Speculum

CODE	BLADE LENGTH	TOTAL LENGTH
79-6675	1 in 25 mm	5 ¼ in 133 mm

Fiber Optic



67-2399FS

Ferreira Style Retractor

With Fiber Optic Light Guide and Suction, Smooth Tip

CODE	DIMENSIONS (D X W)
67-2338FS	14 x 90 mm
67-2121FS	16 x 80 mm
67-2340FS	16 x 150 mm
67-2512FS	25 x 120 mm
67-2339FS	25 x 150 mm
67-2331FS	25 x 190 mm

Fiber Optic



Tebbetts Style Retractor

Serrated Tip, with Fiber Optic Light Guide and Suction

67-2423FS

CODE	DESCRIPTION	BLADE LENGTH
67-2422FS	24 x 90 mm	4 in 100 mm
67-2420FS	24 x 100 mm	4 in 100 mm
67-2425FS	25 x 100 mm	4 in 100 mm
67-2427FS	23 x 150 mm	4 in 100 mm
67-2121FS	16 x 80 mm	
67-2229FS	30 x 90 mm	
67-2230FS	30 x 100 mm	
67-2231FS	30 x 150 mm	
67-2423FS	36 x 190 mm	

Gall Bladders



Foss Gall Bladder Retractor

CODE	DESCRIPTION	DIMENSIONS
23-6300	Gall Bladder Retractor	1¾ x 14½ in 44 x 368 mm



Murphy Gall Bladder Retractor

23-6292

CODE	TOTAL LENGTH	BLADE WIDTH
23-6290	11 in 279 mm	1¾ in 44 mm
23-6292	11 in 279 mm	2 in 51 mm

General Purpose (Finger Retractors)



Meyerding Finger Retractor

50-1070

CODE	DESCRIPTION	DIMENSIONS	
50-1070	A	7 $\frac{1}{8}$ in	181 mm
50-1071	B	7 in	178 mm
50-1072	C	7 in	178 mm
50-1073	D	7 in	178 mm
50-1074	E	7 in	178 mm
50-1075	F	7 in	178 mm

Meyerding Finger Retractor



CODE	DESCRIPTION	DIMENSIONS	
50-4485	Double-Ended, with Skin Hook	7 in	178 mm



Meyerding Finger Retractor

20-1001

CODE	DESCRIPTION	DIMENSIONS	
20-1001	#1		
20-1002	#2	7 $\frac{1}{8}$ in	181 mm
20-1003	#3	7 $\frac{1}{8}$ in	181 mm
20-1004	#4	7 $\frac{1}{8}$ in	181 mm
20-1005	#5	7 $\frac{1}{8}$ in	181 mm
20-1006	#6	7 $\frac{1}{8}$ in	181 mm



Volkman Finger Retractor

22-2603

CODE	DESCRIPTION	LENGTH	
22-2602	2 Prong, Sharp	4 $\frac{1}{8}$ in	105 mm
22-2603	3 Prong, Sharp	4 $\frac{1}{8}$ in	105 mm
22-2604	4 Prong, Sharp	4 $\frac{1}{8}$ in	105 mm
22-2606	6 Prong, Sharp	4 $\frac{1}{8}$ in	105 mm
22-2702	2 Prong, Blunt	4 $\frac{1}{8}$ in	105 mm
22-2703	3 Prong, Blunt	4 $\frac{1}{8}$ in	105 mm
22-2704	4 Prong, Blunt	4 $\frac{1}{8}$ in	105 mm
22-2706	6 Prong, Blunt	4 $\frac{1}{8}$ in	105 mm

General Purpose (Hand-Held)

Deaver Pediatric Retractor

Flexible



23-7217

CODE	WIDTH	DIMENSIONS	
23-7217	17 mm	8 in	203 mm
23-7225	25 mm	8 in	203 mm



22-1015

Farabeuf Pediatric Retractor

CODE	DESCRIPTION	DIMENSIONS	
22-1012	Double-Ended, Set of 2	4 ⁷ / ₈ in	124 mm
22-1015	Double-Ended, Set of 2	6 in	152 mm



B.E. Glass Abdominal Retractor

CODE	DESCRIPTION	WIDTH		LENGTH		TOTAL LENGTH	
24-3380	Abdominal Retractor	3 ¹ / ₄ in	85 mm	6 in	155 mm	9 ³ / ₄ in	245 mm



Blair (Rollet) Retractor

CODE	DESCRIPTION	WIDTH	LENGTH	
63-4010	4 Prong, Sharp	6 mm	5 ¹ / ₄ in	133 mm

General Purpose (Hand-Held)

Boley Retractor



CODE	DESCRIPTION	BLADES (W X D)	LENGTH
50-5608	#1, Double-Ended	$\frac{1}{2} \times \frac{1}{2}$ in 13 x 13 mm $\frac{7}{16} \times \frac{7}{16}$ in 11 x 11 mm	6 $\frac{1}{4}$ in 159 mm

Children's Hospital Retractor



CODE	DESCRIPTION	BLADE (W X D)	LENGTH
50-4100	Small, Double-Ended	$\frac{7}{16} \times \frac{7}{8}$ in 11 x 22 mm $\frac{9}{16} \times 1\frac{3}{8}$ in 14 x 35 mm	5 $\frac{1}{2}$ in 140 mm

Children's Hospital Retractor



CODE	DESCRIPTION	BLADE (W X D)	LENGTH
50-5645	S-Shaped, Double-Ended	$\frac{1}{4} \times \frac{3}{4}$ in 6 x 19 mm $\frac{1}{2} \times \frac{3}{4}$ in 13 x 19 mm	4 $\frac{7}{8}$ in 124 mm

Collins Retractor



CODE	DESCRIPTION	LENGTH	QTY
22-1215	Double-Ended	6 $\frac{1}{2}$ in 165 mm	Set of 2

Converse Alar Retractor

10 mm and 14 mm wide



CODE	DESCRIPTION	LENGTH
67-2010	Double-Ended, Sharp	4 $\frac{3}{4}$ in 120 mm

General Purpose (Hand-Held)



Cottle Alar Retractor

CODE	DESCRIPTION	LENGTH
67-2115	Tapered End, 16–13 mm	6½ in 165 mm



Tip



67-2021

Cottle Retractor

Double Prong, One Ball Tip

CODE	DESCRIPTION	LENGTH
67-2021	Right Prong Sharp	5⅞ in 149 mm
67-2022	Left Prong Sharp	5⅞ in 149 mm



Cottle Tenaculum Hook

CODE	DESCRIPTION	DIMENSIONS
20-4016	Angled	6½ in 160 mm



Cottle-Neivert Retractor

CODE	DESCRIPTION	WIDTH	LENGTH
67-2052	Double-Ended, 2 Prong, Blunt	10 mm	8¼ in 209 mm



20-0930

Crile Retractor

CODE	DESCRIPTION	LENGTH
20-0930	Double-Ended	4½ in 108 mm
50-4105	Double-Ended	4½ in 108 mm

General Purpose (Hand-Held)



32-3633

Cushing Retractor

CODE	JAW LENGTH	LENGTH	CODE	JAW LENGTH	LENGTH
32-3633	10 mm	11 in 279 mm	32-3634	11 mm	14 in 356 mm



Darrach Retractor

CODE	DESCRIPTION	WIDTH	LENGTH
77-6005	Retractor	9 mm	10¼ in 260 mm



50-4316

Deaver Abdominal Retractor

CODE	HANDLE	LENGTH
50-4316	#1 Ring Grip	12 in 304 mm
50-4317	#2 Ring Grip	13 in 330 mm
50-4319	#3 Ring Grip	12 in 304 mm
50-4320	#4 Ring Grip	12 in 304 mm
50-4321	#5 Ring Grip	12 in 304 mm



Deaver Retractor

CODE	DESCRIPTION	DIMENSIONS (W X D)
23-7522	Hollow Handle	2½ x 4 in 64 x 100 mm

General Purpose (Hand-Held)



50-4307

Deaver Retractor

Standard Handle

CODE	DESCRIPTION	WIDTH		LENGTH	
50-4303	#1	1 in	25 mm	12 in	305 mm
50-4304	#2	1 in	25 mm	12 in	305 mm
50-4306	#3	1½ in	38 mm	12 in	305 mm
50-4307	#4	2 in	51 mm	12 in	305 mm
50-4308	#5	3 in	76 mm	12 in	305 mm



23-7211

Deaver Retractor

CODE	DESCRIPTION	WIDTH		LENGTH	
23-7211	Ring-Grip Handle	1 in	25 mm	12 in	305 mm
23-7212	Ring-Grip Handle	1 in	25 mm	12 in	305 mm
23-7213	Ring-Grip Handle	1½ in	38 mm	12 in	305 mm
23-7214	Ring-Grip Handle	2 in	51 mm	12 in	305 mm
23-7215	Ring-Grip Handle	3 in	76 mm	12 in	305 mm
23-7216	Ring-Grip Handle	4 in	102 mm	12 in	305 mm
23-7218	Ring-Grip Handle	2 in	51 mm	15 in	305 mm
23-7221	Ring-Grip Handle	1 in	25 mm	16 in	405 mm



Deaver Abdominal Retractor

CODE	DESCRIPTION	DIMENSIONS	
23-7244	Abdominal Retractor	1x10 in	25x254 mm

General Purpose (Hand-Held)



50-4307

Deaver Retractor

Standard Handle

CODE	DESCRIPTION	WIDTH		LENGTH	
50-4303	#1	1 in	25 mm	12 in	305 mm
50-4304	#2	1 in	25 mm	12 in	305 mm
50-4306	#3	1½ in	38 mm	12 in	305 mm
50-4307	#4	2 in	51 mm	12 in	305 mm
50-4308	#5	3 in	76 mm	12 in	305 mm

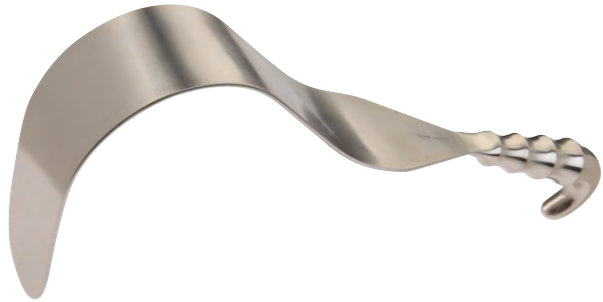

Deaver Abdominal Retractor

CODE	BLADE LENGTH	HANDLE LENGTH	
32-3635	2½ in (640 mm)	14½ in	368 mm



50-5630

Deaver Abdominal Retractor

CODE	DEPTH		WIDTH		DIMENSIONS	
50-5629	2½ in	63 mm	¾ in	10 mm	8 in	203 mm
50-5630	2½ in	63 mm	⅝ in	15 mm	8 in	203 mm
50-5631	2½ in	63 mm	1 in	25 mm	8 in	203 mm

General Purpose (Hand-Held)



Delee Universal Retractor

CODE	LENGTH
52-2340	9½ in 241 mm
50-5575	9½ in 241 mm



Flexible Neck Retractor

20-6453

CODE	DESCRIPTION	LENGTH	CODE	DESCRIPTION	LENGTH
20-6452	2 Prong, Sharp	6¼ in 159 mm	20-6552	2 Prong, Blunt	6¼ in 159 mm
20-6453	3 Prong, Sharp	6¼ in 159 mm	20-6553	3 Prong, Blunt	6¼ in 159 mm



Fomon Hook Retractor

CODE	DESCRIPTION	TIP WIDTH	LENGTH	DIMENSIONS
67-2025	Both Prong Ball Tipped	13 mm	6¾ in 171 mm	10¼ x 2 x 2½ in 260 x 51 x 64 mm



22-2001

Freeman Rake Retractor

CODE	WIDTH	LENGTH
22-2001	1½ in 38 mm	7 in 178 mm
22-2004	¾ in 22 mm	7 in 178 mm

General Purpose (Hand-Held)



23-3752

Goelet General Purpose Retractor

CODE	DESCRIPTION	DIMENSIONS	
50-4095	Double-Ended	7 ½ in	191 mm
23-3752	Double-Ended	7 ½ in	191 mm



Gorney Rake Spring Neck Retractor

CODE	DESCRIPTION	LENGTH	
20-2011	4 Prong, Sharp	3 in	76 mm



23-6381

Hibbs Retractor

CODE	DESCRIPTION	DIMENSIONS (W X D)		DIMENSIONS	
23-6381	Sharp Teeth	1 x 3 in	25 x 76 mm	9 in	228 mm
23-6382	Sharp Teeth	1 x 3 ¼ in	25 x 82 mm	9 in	228 mm
50-2558C	Double Ended, Set of 2	¾ x 2 in	19 x 51 mm	9 ¼ in	235 mm



22-7204

Israel Retractor

CODE	DESCRIPTION	PRONGS	BLADES (W X D)	LENGTH	
50-4246	Blunt	4 Prong	1 ¾ x 1 ¾ in	44 x 44 mm	7 ¾ in 197 mm
22-7204	Blunt	4 Prong	1 ½ x 1 ½ in	38 x 38 mm	10 in 254 mm
22-7205	Blunt	5 Prong	2 x 1 ¾ in	51 x 44 mm	10 in 254 mm
22-7206	Blunt	6 Prong	2 ¾ x 2 in	60 x 51 mm	10 in 254 mm

General Purpose (Hand-Held)



23-4701

Kelly Retractor

CODE	DESCRIPTION	BLADE (W X L)		LENGTH	
23-4701	Standard Handle	1½ x 2 in	35 x 51 mm	10¼ in	260 mm
23-4702	Standard Handle	2 x 2½ in	51 x 64 mm	10¼ in	260 mm
23-4703	Standard Handle	2½ x 3 in	64 x 76 mm	10¼ in	260 mm
23-4711	Lamb Handle	1¼ x 2 in	32 x 51 mm	10¼ in	260 mm
23-4712	Lamb Handle	2 x 2½ in	51 x 64 mm	10¼ in	260 mm
23-4713	Lamb Handle	2½ x 3 in	64 x 76 mm	10¼ in	260 mm
23-4714	Lamb Handle	3 x 3½ in	76 x 89 mm	10¼ in	260 mm
23-4715	Ring-Grip Handle	1½ x 2 in	38 x 51 mm	10¼ in	260 mm
23-4716	Ring-Grip Handle	2 x 2½ in	51 x 64 mm	10¼ in	260 mm
23-4717	Ring-Grip Handle	2½ x 3 in	63 x 76 mm	10¼ in	260 mm
23-4718	Ring-Grip Handle	3 x 3½ in	76 x 89 mm	10¼ in	260 mm



50-4117

Kelly Retractor

Ring-Grip Handle

CODE	DESCRIPTION	BLADE (W X D)		LENGTH	
50-4115	Small	1½ x 2 in	38 x 51 mm	9¼ in	235 mm
50-4116	Medium	2 x 2½ in	51 x 64 mm	9¼ in	235 mm
50-4117	Large	2½ x 3 in	64 x 76 mm	10 in	254 mm
50-4118	XL	3 x 3½ in	76 x 89 mm	10 in	254 mm

Kelly Retractor

Standard Handle

CODE	DESCRIPTION	BLADE (W X D)		LENGTH	
50-4110	Small	1½ x 2 in	38 x 51 mm	9¼ in	235 mm
50-4111	Medium	2 x 2½ in	51 x 64 mm	9½ in	241 mm
50-4112	Large	2½ x 3 in	64 x 76 mm	10 in	254 mm



50-4110

General Purpose (Hand-Held)



Knapp Retractor

20-5516

CODE	DESCRIPTION	PRONGS	WIDTH	LENGTH
20-5516	Sharp	4 Prong	6 mm	5 in 127 mm
20-5517	Blunt	4 Prong	6 mm	5 in 127 mm



Langenbeck Retractor

23-0710

CODE	DESCRIPTION	BLADE (W X D)	LENGTH
23-0710	Hollow Handle	$\frac{3}{8}$ x $1\frac{1}{2}$ in 10 x 38 mm	8 $\frac{3}{4}$ in 222 mm
50-4255	#1	$\frac{3}{8}$ x $1\frac{5}{8}$ in 10 x 41 mm	8 $\frac{1}{4}$ in 210 mm
50-4256	#2	$\frac{1}{2}$ x $1\frac{5}{8}$ in 13 x 41 mm	8 $\frac{1}{4}$ in 210 mm
23-0713	Hollow Handle	$\frac{1}{2}$ x $1\frac{1}{16}$ in 13 x 43 mm	8 $\frac{3}{4}$ in 222 mm
23-0716	Hollow Handle	$\frac{5}{8}$ x $1\frac{1}{16}$ in 16 x 43 mm	8 $\frac{3}{4}$ in 222 mm



Mathieu Retractor

3 Prong Blade, Double-Ended

50-4291

CODE	DESCRIPTION	PRONG WIDTH	DIMENSIONS (W X D)	TOTAL LENGTH
50-4291	Blunt	$\frac{3}{8}$ in 10 mm	$\frac{1}{4}$ x $\frac{3}{4}$ in 6 x 19 mm	5 $\frac{1}{8}$ in 20 mm
50-4290	Sharp	$\frac{3}{8}$ in 10 mm	$\frac{1}{4}$ x $\frac{3}{4}$ in 6 x 19 mm	6 $\frac{1}{2}$ in 165 mm



Mathieu Retractor

23-6301

CODE	DESCRIPTION	PRONG WIDTH	BLADE WIDTH	BLADE DEPTH	LENGTH
50-4290	Double-Ended, 3 Prong, Sharp	$\frac{3}{8}$ in 10 mm	$\frac{1}{4}$ in 6 mm	$\frac{3}{4}$ in 19 mm	6 $\frac{1}{2}$ in 165 mm

General Purpose (Hand-Held)

Mayo Abdominal Retractor



CODE	LENGTH
23-6346 2¾ in 70 mm	10 in 254 mm

Miller Rake Retractor



22-2043

CODE	DESCRIPTION	LENGTH
22-2043	9 Prong, Sharp	5¼ in 140 mm
22-2044	9 Prong, Blunt	5¼ in 140 mm

Murphy Retractor



22-5004

CODE	DESCRIPTION	LENGTH
22-5004	4 Prong, Sharp	7¾ in 197 mm
50-8072	4 Prong, Sharp	7¾ in 197 mm
22-5006	6 Prong, Sharp	7¾ in 197 mm
22-5103	3 Prong, Blunt	7¾ in 197 mm
22-5104	4 Prong, Blunt	7¾ in 197 mm
22-5106	6 Prong, Blunt	7¾ in 197 mm

Oldberg Retractor



57-5253

CODE	DESCRIPTION	TIP WIDTH	LENGTH
57-5250	Plain	9 mm	8¼ in 209 mm
57-5253	3 Prong	13 mm	8¼ in 209 mm
57-5254	4 Prong	15 mm	8¼ in 209 mm
57-5256	6 Prong	19 mm	8¼ in 209 mm

General Purpose (Hand-Held)



67-2050

Neivert Knife Guide & Retractor

CODE	DESCRIPTION	TIP WIDTH	LENGTH	DIMENSIONS
67-2051	Double-Ended with 2 Ball Tips	10 mm	7½ in 190 mm	6½ in 165 mm
67-2050	Double-Ended	10 mm	7½ in 190 mm	6½ in 165 mm



Obwegeser Retractor

CODE	DESCRIPTION	DIMENSIONS	LENGTH
68-1006	Curved Down	¾ x 1¼ in 10 x 42 mm	8¾ in 222 mm



50-4253

Ollier Retractor

CODE	DESCRIPTION	LENGTH
22-7002	4 Prong, Blunt	8½ in 216 mm
50-4253	4 Prong, Blunt	9 in 229 mm



50-4091

Parker Retractor

Double-Ended

CODE	DESCRIPTION	LENGTH	QTY
22-1413	Small	5 in 127 mm	Set of 2
50-4090	Small	5½ in 140 mm	Set of 2
22-1418	Large	7 in 176 mm	Set of 2



Parker Mott Retractor

CODE	DESCRIPTION	LENGTH	QTY
22-1516	Double-Ended	6½ in 166 mm	Set of 2

General Purpose (Hand-Held)



Pelvic Retractor

CODE	DESCRIPTION	TIP WIDTH	LENGTH
77-1014	Pelvic Retractor	24 mm	10 3/4 in 273 mm



50-2608

Ragnell Retractor

CODE	DESCRIPTION	BLADE (W X D)	LENGTH
50-2608	Double-Ended	1/8 x 1/4 in 3 x 6 mm 1/4 x 5/8 in 6 x 16 mm	6 in 152 mm
20-0525	Double-Ended	1/8 x 1/4 in 3 x 6 mm	6 in 152 mm
20-0526	Double-Ended	1/8 x 3/16 in 3 x 5 mm	6 in 152 mm



Rake Retractor

CODE	DESCRIPTION	LENGTH
22-5806	6 Prong, Sharp	9 1/2 in 241 mm

Ribbon Retractor

Double-Ended, Malleable



22-0006

CODE	WIDTH	LENGTH	CODE	WIDTH	LENGTH
22-0006	1/4 in 6 mm	8 in 203 mm	22-0253	1 1/4 in 32 mm	13 in 330 mm
22-0012	1/2 in 13 mm	8 in 203 mm	22-0254	1 1/2 in 38 mm	13 in 330 mm
22-0017	5/8 in 16 mm	8 in 203 mm	22-0255	2 in 51 mm	13 in 330 mm
22-0025	1 in 25 mm	8 in 203 mm	22-0256	2 1/2 in 64 mm	13 in 330 mm
22-0027	1 in 25 mm	10 in 254 mm	22-0257	3 in 76 mm	13 in 330 mm
22-0035	1 3/4 in 44 mm	10 in 254 mm	22-0258	4 in 102 mm	13 in 330 mm
22-0251	3/4 in 19 mm	13 in 330 mm	22-0259	5 in 127 mm	13 in 330 mm
22-0252	1 in 25 mm	13 in 330 mm			

General Purpose (Hand-Held)



50-4212

Ribbon Malleable Retractor

CODE	DESCRIPTION	BLADE WIDTH		LENGTH	
50-5637	Double-Ended	½ in	13 mm	8 in	203 mm
50-5639	Double-Ended	¾ in	19 mm	8 in	203 mm
50-4210	Double-Ended	1 in	25 mm	13 in	330 mm
50-4212	Double-Ended	1½ in	38 mm	13 in	330 mm
50-4214	Double-Ended	2 in	51 mm	13 in	330 mm



23-4501

Richardson Retractor

CODE	DESCRIPTION	BLADE (W X D)		LENGTH	
23-4501	Standard Handle	¾ x 1 in	19 x 25 mm	9½ in	241 mm
23-4502	Standard Handle	1 x 1¼ in	25 x 32 mm	9½ in	241 mm
23-4503	Standard Handle	1½ x 1½ in	38 x 38 mm	9½ in	241 mm
23-4504	Standard Handle	¾ x 2 in	19 x 51 mm	9½ in	241 mm
23-4505	Standard Handle	1⅝ x 2½ in	41 x 64 mm	9½ in	241 mm



23-4514

Richardson Retractor

CODE	DESCRIPTION	BLADE (W X D)		LENGTH	
23-4511	Lamb Handle	¾ x 1 in	19 x 25 mm	9½ in	241 mm
23-4512	Lamb Handle	1 x 1¼ in	25 x 32 mm	9½ in	241 mm
23-4514	Lamb Handle	¾ x 2 in	19 x 51 mm	9½ in	241 mm

General Purpose (Hand-Held)



50-4122

Richardson Retractor

CODE	DESCRIPTION	SIZE	BLADE (W X D)		LENGTH	
23-4515	Ring-Grip Handle	Small	$\frac{3}{4}$ x 1 in	19 x 25 mm	9 $\frac{1}{2}$ in	241 mm
23-4516	Ring-Grip Handle	Medium	1 x $1\frac{1}{4}$ in	25 x 32 mm	9 $\frac{1}{2}$ in	241 mm
23-4517	Ring-Grip Handle	Large	$1\frac{1}{2}$ x $1\frac{1}{2}$ in	38 x 38 mm	9 $\frac{1}{2}$ in	241 mm
23-4518	Ring-Grip Handle	Small	$\frac{3}{4}$ in x 2 in	19 x 51 mm	9 $\frac{1}{2}$ in	241 mm
23-4520	Ring-Grip Handle	Medium	$1\frac{3}{16}$ x 4 in	30 x 100 mm	9 $\frac{1}{2}$ in	241 mm
50-4120	Standard Handle	Small	$\frac{3}{4}$ x 1 in	19 x 25 mm	9 $\frac{1}{4}$ in	235 mm
50-4121	Standard Handle	Medium	1 x $1\frac{1}{4}$ in	25 x 32 mm	9 $\frac{1}{4}$ in	235 mm
50-4122	Standard Handle	Large	$1\frac{1}{2}$ x $1\frac{3}{4}$ in	38 x 44 mm	9 $\frac{1}{2}$ in	241 mm
50-4123C	Ring-Grip Handle	Small	$\frac{3}{4}$ x 1 in	19 x 25 mm	9 $\frac{1}{2}$ in	241 mm
50-4124C	Ring-Grip Handle	Medium	1 x $1\frac{1}{4}$ in	32 mm	9 $\frac{1}{2}$ in	241 mm
50-4125C	Ring-Grip Handle	Large	$1\frac{1}{4}$ x $1\frac{1}{2}$ in	38 mm	9 $\frac{1}{2}$ in	241 mm



23-4550

Richardson-Eastman Retractor

Double-Ended

CODE	DESCRIPTION	BLADE (W X D)		LENGTH	
23-4550	Set of Two	$\frac{7}{8}$ x $\frac{5}{16}$ in	22 x 8 mm	10 in	254 mm
23-4551	Small Only	$1\frac{1}{2}$ x $1\frac{5}{8}$ in	38 x 41 mm	10 in	254 mm
23-4552	Large Only	$1\frac{3}{16}$ x $1\frac{3}{16}$ in	44 x 64 mm	10 $\frac{1}{2}$ in	267 mm
50-4135C	Set of Two (Small and Large)	$1\frac{3}{4}$ x $2\frac{1}{2}$ in	44 x 64 mm	10 in	254 mm

Roux Retractor

Double-Ended



22-1614

CODE	BLADE (W X D)		LENGTH	
22-1614	$\frac{7}{8}$ x $1\frac{1}{8}$ in	22 x 29 mm	5 $\frac{1}{2}$ in	140 mm
22-1615	1 x $1\frac{1}{2}$ in	25 x 38 mm	6 in	152 mm
22-1616	$1\frac{1}{4}$ x $1\frac{3}{4}$ in	32 x 45 mm	6 $\frac{1}{2}$ in	166 mm

General Purpose (Hand-Held)



23-1501

Sauerbruch Retractor

CODE	DESCRIPTION	BLADE (W X D)	LENGTH
23-1501	#1	$\frac{3}{4} \times 1\frac{3}{4}$ in 19 x 44 mm	9 in 229 mm
23-1502	#2	$\frac{15}{16} \times 2\frac{1}{8}$ in 24 x 54 mm	9 in 229 mm
23-1503	#3	$\frac{13}{16} \times 2\frac{7}{8}$ in 21 x 73 mm	9 in 229 mm



Schoenborn Retractor

CODE	BLADE (W X D)	LENGTH
20-4460	$\frac{1}{2} \times \frac{1}{4}$ in 13 x 6 mm	8 in 203 mm



50-4261

Senn Retractor

Double-Ended

CODE	DESCRIPTION	PRONG (W)	BLADE (W X D)	LENGTH
20-0508	3 Prong, Sharp	$\frac{5}{16}$ in 8 mm	$\frac{1}{4} \times \frac{3}{4}$ in 6 x 19 mm	6 $\frac{1}{4}$ in 159 mm
50-4260	3 Prong, Sharp	$\frac{5}{16}$ in 8 mm	$\frac{1}{4} \times \frac{3}{4}$ in 6 x 19 mm	6 $\frac{7}{8}$ in 175 mm
20-0509	3 Prong, Blunt	$\frac{5}{16}$ in 8 mm	$\frac{1}{4} \times \frac{3}{4}$ in 6 x 19 mm	6 $\frac{1}{4}$ in 159 mm
50-4261	3 Prong, Blunt	$\frac{5}{16}$ in 8 mm	$\frac{1}{4} \times \frac{3}{4}$ in 6 x 19 mm	6 $\frac{7}{8}$ in 175 mm

General Purpose (Hand-Held)

Sofield Hand-Held Retractor

Double Ended



32-3661

CODE	DESCRIPTION	DIMENSIONS
32-3667	For use with 32-3660	5 1/2 in 140 mm
32-3661	Sofield Retractor	63 x 13 mm and 38 x 13 mm
32-3662	Sofield Retractor	70 x 13 mm and 44 x 13 mm
32-3664	Sofield Retractor	89 x 16 mm and 57 x 16 mm
32-3665	Sofield Retractor	102 x 19 mm and 70 x 19 mm
32-3666	Sofield Retractor	114 x 19 mm and 76 x 19 mm

Sofield Retractor

Double Ended



22-1553

CODE	DESCRIPTION	DIMENSIONS
22-1551	Sofield Retractor	63 x 13 mm and 38 x 13 mm
22-1552	Sofield Retractor	70 x 13 mm and 44 x 13 mm
22-1553	Sofield Retractor	83 x 16 mm and 51 x 16 mm
22-1554	Sofield Retractor	89 x 16 mm and 57 x 16 mm
22-1555	Sofield Retractor	102 x 19 mm and 70 x 19 mm
22-1556	Sofield Retractor	114 x 19 mm and 76 x 19 mm

St. Marks Retractor



CODE	DESCRIPTION	DIMENSIONS
502-002	With Lip, 51–64 mm Taper	5 in 127 mm

General Purpose (Hand-Held)



St. Marks Pelvic Retractor

CODE	DESCRIPTION	HANDLE	BLADE	LENGTH
50-9023	With Lip		5 in 127 mm	13 in 330 mm
50-9028	With Lip	Angled 15°	11 in 279 mm	13 in 330 mm
50-9024	With Lip	Angled	5 in 127 mm	
50-9027	With Lip	Angled 15°	9 in 229 mm	11½ in 292 mm
50-9025	With Lip	Angled 15°	7 in 178 mm	13¾ in 350 mm
50-9020	Tapered, with Lip	Angled	7 in 178 mm	13¾ in 350 mm
50-9020FO	Tapered, with Lip; Fiber Optic Attachment	Angled	7 in 178 mm	13¾ in 350 mm
50-9025FO	With Lip, Fiber Optic Attachment	Angled 15°	7 in 178 mm	13⅞ in 340 mm
50-9027FO	With Lip, Fiber Optic Attachment	Angled 15°	9 in 229 mm	13⅞ in 340 mm
50-9026	Without Lip		7 in 178 mm	11 in 279 mm



St. Marks Pelvic Retractor

With Ratchet and Swivel Blades

CODE	LENGTH
50-9021	11 in 279 mm



32-3628

Turner-Doyen Retractor Blade

CODE	WIDTH	DEPTH	TOTAL LENGTH
32-3628	2⅜ in 60 mm	5½ in 140 mm	11½ in 292 mm

General Purpose (Hand-Held)

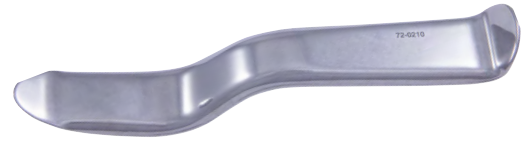

University Of Minnesota Retractor & Tongue Depressor

CODE	DESCRIPTION	DIMENSIONS	
72-0210	Cheek Retractor	5½ in	140 mm

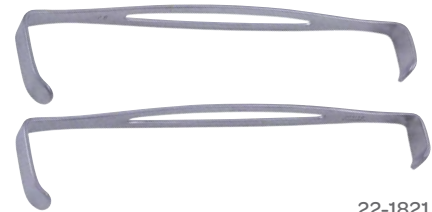

22-1821

Us Army Retractor

CODE	DESCRIPTION	DIMENSIONS	
22-1821	Double-Ended, Set of 2	8¼ in	209 mm
50-4071	Double-Ended, Set of 2	8¼ in	209 mm



50-4226CO

Volkman Retractor

CODE	DESCRIPTION	BLADE (W X D)	LENGTH
22-3402	2 Prong, Sharp	Standard Pattern	8¾ in 222 mm
22-3403	3 Prong, Sharp	Standard Pattern	8¾ in 222 mm
22-3404	4 Prong, Sharp	Standard Pattern	8¾ in 222 mm
22-3406	6 Prong, Sharp	Standard Pattern	8¾ in 222 mm
22-3502	2 Prong, Blunt	Standard Pattern	8¾ in 222 mm
22-3503	3 Prong, Blunt	Standard Pattern	8¾ in 222 mm
22-3504	4 Prong, Blunt	Standard Pattern	8¾ in 222 mm
22-3506	6 Prong, Blunt	Standard Pattern	8¾ in 222 mm
50-4220CO	2 Prong, Sharp	7/16 x 11/16 in 11 x 17 mm	8¾ in 222 mm
50-4221CO	3 Prong, Sharp	11/16 x 11/16 in 11 x 17 mm	8¾ in 222 mm
50-4222CO	4 Prong, Sharp	15/16 x 11/16 in 24 x 17 mm	8¾ in 222 mm
50-4223CO	6 Prong, Sharp	1½ x 11/16 in 17 x 38 mm	8¾ in 222 mm
50-4225CO	2 Prong, Blunt	7/16 x 11/16 in 11 x 17 mm	8¾ in 222 mm
50-4226CO	3 Prong, Blunt	11/16 x 11/16 in 17 x 17 mm	8¾ in 222 mm
50-4227CO	4 Prong, Blunt	15/16 x 11/16 in 24 x 17 mm	8¾ in 222 mm
50-4228CO	6 Prong, Blunt	1½ x 11/16 in 38 x 17 mm	8¾ in 222 mm

General Purpose (Lighted)



67-2490

Fiber Optic Retractor

CODE	DESCRIPTION	DIMENSIONS
67-2490	Judy's Skini Mini	$1\frac{5}{32}$ x $3\frac{3}{8}$ in 12 x 85 mm
67-2492	Judy's Skini Mini	$1\frac{5}{32}$ x $4\frac{3}{4}$ in 12 x 120 mm

General Purpose (Self-Retaining)



32-3654

Henly Retractor Blade

CODE	DESCRIPTION	DIMENSIONS
32-3652	3 Pair Side Blades, 4 Center Blades	
32-3654	Center	$\frac{5}{8}$ x $\frac{3}{4}$ in 16 x 19 mm
32-3655	Center	$\frac{5}{8}$ x 1 in 16 x 25 mm
32-3656	Center	$\frac{5}{8}$ x $1\frac{1}{4}$ in 16 x 32 mm
32-3657	Left/Right, Pair	1 x 1 in 25 x 25 mm
32-3658	Left/Right, Pair	1 x 2 in 25 x 51 mm
32-3659	Left/Right, Pair	$\frac{7}{8}$ x 3 in 22 x 76 mm
32-3653	Body Only: $3\frac{3}{16}$ in, Max Opening 80 mm	



Gelpi Perineal Retractor

CODE	DESCRIPTION	TOTAL OPENING	LENGTH
50-1210	Self-Retaining	$3\frac{3}{4}$ in 95 mm	$7\frac{1}{4}$ in 184 mm

General Purpose (Self-Retaining)



24-4013

Gelpi Retractor

CODE	DESCRIPTION	LENGTH	WIDTH
24-4013		3½ in 89 mm	
24-4015		4½ in 114 mm	
24-4018		6¾ in 121 mm	
24-4017	Tips Bent 90°	6¾ in	171 mm
24-4057	With Ball Stops	7½ in	191 mm



50-8160

Darling Popliteal Retractor

CODE	DESCRIPTION	DIMENSIONS
55-8998	Left	6¼ in 159 mm
55-8997	Right	6¼ in 159 mm
50-8160	Self-Retaining, Left	6¼ in 159 mm
50-8161	Self-Retaining, Right	6¼ in 159 mm

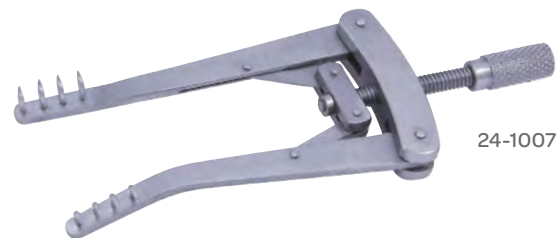

24-1007

Alm Self-Retaining Retractor

CODE	DESCRIPTION	LENGTH
24-1007	4 x 4 Prongs, Sharp	2¾ in 70 mm
24-1010	4 x 4 Prongs, Sharp	4 in 102 mm
24-1008	4 x 4 Prongs, Blunt	2¾ in 70 mm
24-1011	4 x 4 Prongs, Blunt	4 in 102 mm

General Purpose (Self-Retaining)



80-1813

Alm Retractor-Microvasc Modified Alm Retractor

Black Anodized

CODE	DESCRIPTION	LENGTH
80-1812	4 x 4 Prong	8 ¼ in 210 mm
80-1813	12 x 12 Prong	8 ¼ in 210 mm



Alms Wound Retractor

CODE	DESCRIPTION	PRONG DEPTH	TOTAL OPENING	LENGTH
50-4265	Semi-Sharp Prongs	⅛ in 3 mm	2 in 51 mm	3 in 76 mm



Bellucci Retractor

CODE	DESCRIPTION	LENGTH
24-2625	Arms Angled Downward, 3 x 3 Prong, Sharp	5 ⅛ in 130 mm



61-0605

Bellucci-Wullstein Retractor

CODE	DESCRIPTION	LENGTH
61-0606	Solid Blade on Left, 2 Prong, Blunt	5 in 140 mm
61-0605	Solid Blade on Right, 2 Prong, Blunt	5 in 140 mm

General Purpose (Self-Retaining)

Farr Spring Retractor

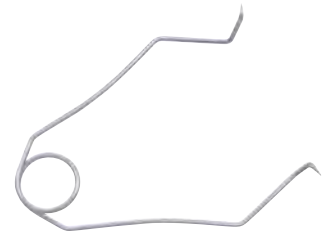

24-0307

CODE	PRONG	LENGTH
24-0307	1 in 25 mm	5½ in 140 mm
24-0306	1 in 25 mm	9 in 229 mm

Heiss Retractor

4 x 4 Prongs, Cross-Action



24-0911

CODE	DESCRIPTION	LENGTH	CODE	DESCRIPTION	LENGTH
24-0909	Sharp	4 in 102 mm	24-0910	Blunt	4 in 102 mm
24-0911	Sharp	4 in 102 mm	24-0912	Blunt	4 in 102 mm

Hinterman Retractor

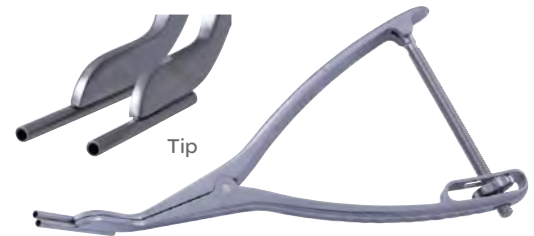

CODE	DESCRIPTION	LENGTH
78-5599	With K-Wire Guide	7 in 177 mm

Horizontal Retractor

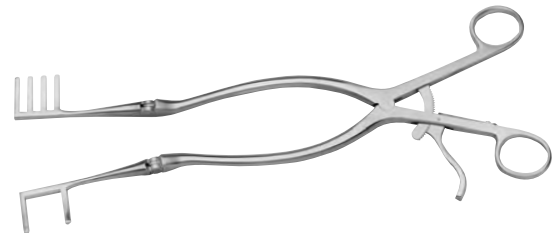

CODE	DESCRIPTION	LENGTH
24-3500	4 x 2 Sharp Prong	12¼ in 310 mm

General Purpose (Self-Retaining)



Kolbel Retractor

CODE	DESCRIPTION	LENGTH
24-4175	2 x 2 in, Prongs, Angled	7 in 177 mm



24-4167

Kolbel Retractor

CODE	DESCRIPTION	DIMENSIONS (W X D)	
24-4166	Frame Only for Snap Closure Blades		
24-4167	Kolbel Snap on Retractor Blades	36 x 36 in	1 ⁷ / ₁₆ in, 1 ⁷ / ₁₆ in
24-4168	Kolbel Snap on Retractor Blades	36 x 53 in	1 ⁷ / ₁₆ in, 2 ¹ / ₁₆ in
24-4169	Kolbel Snap on Retractor Blades	36 x 68 in	1 ⁷ / ₁₆ in, 2 ¹¹ / ₁₆ in
24-4170	Kolbel Snap on Retractor Blades	36 x 85 in	1 ⁷ / ₁₆ in, 3 ³ / ₈ in
24-4172	Kolbel Snap on Retractor Blades	20 x 36 in	1 ³ / ₁₆ in, 1 ⁷ / ₁₆ in
24-4173	Kolbel Snap on Retractor Blades	20 x 53 in	1 ³ / ₁₆ in, 2 ¹ / ₁₆ in
24-4176	Kolbel Snap on Retractor Blades	20 x 68 in	1 ³ / ₁₆ in, 2 ¹¹ / ₁₆ in
24-4178	Kolbel Snap on Retractor Blades	20 x 85 in	1 ³ / ₁₆ in, 3 ³ / ₈ in

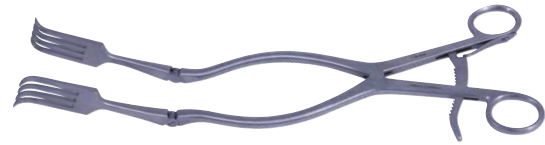

Oberhill Retractor

CODE	DESCRIPTION	LENGTH
24-3449	4 Prong Hinged Blades	13 in 330 mm



66-6651

Perkins Retractor

Solid Blades with Spikes

CODE	DESCRIPTION	SPREAD
66-6650	3 Sharp Prong on Left	5 in 127 mm
66-6651	3 Sharp Prong on Right	5 in 127 mm

General Purpose (Self-Retaining)

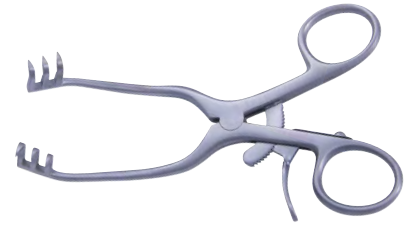

Schuknecht Retractor

CODE	DESCRIPTION	DIMENSIONS	
24-2620	Double Curved Arms, 3 x 3 Prong, Sharp	5 1/8 in	130 mm



Seeburger Retractor

CODE	DIMENSIONS
22-0101	5 1/2 in 140 mm



Spring Retractor

CODE	DESCRIPTION	LENGTH	
24-0300	1 x 1 Prong, Sharp	2 1/2 in	64 mm
24-0301	1 x 1 Prong, Sharp	3 1/2 in	89 mm
24-0352	1 x 1 Prong, Sharp	4 1/8 in	105 mm
24-0302	1 x 1 Prong, Sharp	4 1/2 in	114 mm
24-0327	1 x 1 Prong, Sharp		
24-0303	3 x 3 Prongs, Blunt	3 1/2 in	89 mm
24-0304	3 x 3 Prongs, Blunt	4 1/2 in	114 mm
50-4350	Prong 3/8 in, (10 mm)	3 1/8 in	79 mm

Tissue Retractors

Blunt



CODE	DESCRIPTION	PRONG (W X D)		TOTAL OPENING		LENGTH	
50-1223	3 x 3 Prongs	1/2 in	5/8 in	13 x 16 mm	2 1/2 in	64 mm	5 1/4 in 133 mm
50-1224	1 x 1 Prong	1/2 in		13 mm	2 1/2 in	64 mm	5 1/4 in 133 mm

General Purpose (Hand-Held)



Volkman Retractor

CODE	DESCRIPTION	DIMENSIONS	
22-3604	4 Prong Sharp, USA Pattern	8 ³ / ₄ in	222 mm



Volkman Retractor

50-4226CO

CODE	DESCRIPTION	BLADE (W X D)		LENGTH	
22-3402	2 Prong, Sharp	Standard Pattern		8 ³ / ₄ in	222 mm
22-3403	3 Prong, Sharp	Standard Pattern		8 ³ / ₄ in	222 mm
22-3404	4 Prong, Sharp	Standard Pattern		8 ³ / ₄ in	222 mm
22-3406	6 Prong, Sharp	Standard Pattern		8 ³ / ₄ in	222 mm
22-3502	2 Prong, Blunt	Standard Pattern		8 ³ / ₄ in	222 mm
22-3503	3 Prong, Blunt	Standard Pattern		8 ³ / ₄ in	222 mm
22-3504	4 Prong, Blunt	Standard Pattern		8 ³ / ₄ in	222 mm
22-3506	6 Prong, Blunt	Standard Pattern		8 ³ / ₄ in	222 mm
50-4220CO	2 Prong, Sharp	⁷ / ₁₆ x ¹¹ / ₁₆ in	11 x 17 mm	8 ³ / ₄ in	222 mm
50-4221CO	3 Prong, Sharp	¹¹ / ₁₆ x ¹¹ / ₁₆ in	11 x 17 mm	8 ³ / ₄ in	222 mm
504222CO	4 Prong, Sharp	¹⁵ / ₁₆ x ¹¹ / ₁₆ in	24 x 17 mm	8 ³ / ₄ in	222 mm
50-4223CO	6 Prong, Sharp	1 ¹ / ₂ x ¹¹ / ₁₆ in	17 x 38 mm	8 ³ / ₄ in	222 mm
50-4225CO	2 Prong, Blunt	⁷ / ₁₆ x ¹¹ / ₁₆ in	11 x 17 mm	8 ³ / ₄ in	222 mm
50-4226CO	3 Prong, Blunt	¹¹ / ₁₆ x ¹¹ / ₁₆ in	17 x 17 mm	8 ³ / ₄ in	222 mm
504227CO	4 Prong, Blunt	¹⁵ / ₁₆ x ¹¹ / ₁₆ in	24 x 17 mm	8 ³ / ₄ in	222 mm
50-4228CO	6 Prong, Blunt	1 ¹ / ₂ x ¹¹ / ₁₆ in	38 x 17 mm	8 ³ / ₄ in	222 mm

General Purpose (Self-Retaining)



Weitlaner-Beckman Retractor

CODE	DESCRIPTION	LENGTH
24-3013	3 x 4 Prong, Sharp, Hinged Arms	5½ in 140 mm
24-3016	3 x 4 Prong, Sharp, Hinged Arms	6½ in 165 mm
24-3020	3 x 4 Prong, Sharp, Hinged Arms	8½ in 215 mm
24-3023	3 x 4 Prong, Sharp, Hinged Arms	9½ in 241 mm
24-3014	3 x 4 Prong, Blunt, Hinged Arms	5½ in 140 mm
24-3017	3 x 4 Prong, Blunt, Hinged Arms	6½ in 165 mm
24-3024	3 x 4 Prong, Blunt, Hinged Arms	8 in 215 mm
24-3021	3 x 4 Prong, Blunt, Hinged Arms	9½ in 241 mm



Weitlaner Retractor

CODE	DESCRIPTION	LENGTH
24-2210	2 x 3 Prongs, Sharp	4½ in 114 mm
24-2213	3 x 4 Prongs, Sharp	5½ in 140 mm
24-2216	3 x 4 Prongs, Sharp	6½ in 165 mm
24-2220	3 x 4 Prongs, Sharp	8 in 203 mm
24-2224	3 x 4 Prongs, Sharp	9 in 229 mm
24-2211	2 x 3 Prongs, Blunt	4½ in 114 mm
24-2214	3 x 4 Prongs, Blunt	5½ in 140 mm
24-2217	3 x 4 Prongs, Blunt	6½ in 165 mm
24-2221	3 x 4 Prongs, Blunt	8 in 203 mm
24-2225	3 x 4 Prongs, Blunt	9 in 229 mm



Weitlaner Pediatric Retractor

CODE	DESCRIPTION	DIMENSIONS
61-0610	3 x 3 Prong, Blunt	4½ in 115 mm

General Purpose (Self-Retaining)



Weitlaner Retractor

CODE	DESCRIPTION	TOTAL OPENING	LENGTH
50-5647	2 x 3 Prong, Blunt	2¼ in 57 mm	4½ in 114 mm



50-1194

Weitlaner Retractor

Self-Retaining Prongs

CODE	DESCRIPTION	TOTAL OPENING	LENGTH
50-5646	2 X 3 Prongs, Sharp	2¼ in 57 mm	4½ in 114 mm
50-1194	3 x 4 Prongs, Sharp	2¼ in 57 mm	5½ in 140 mm
50-1196	3 x 4 Prongs, Sharp	4 in 102 mm	6½ in 165 mm
50-1198	3 x 4 Prongs, Sharp	5 in 127 mm	7½ in 191 mm
50-1200	3 X 4 Prongs, Sharp	5¾ in 146 mm	9 in 229 mm
50-5647	2 X 3 Prongs, Blunt	2¼ in 57 mm	4½ in 114 mm
50-1195	3 x 4 Prongs, Blunt	2¼ in 57 mm	5½ in 140 mm
50-1197	3 x 4 Prongs, Blunt	4 in 102 mm	6½ in 165 mm
50-1199	3 x 4 Prongs, Blunt	5 in 127 mm	7½ in 191 mm
50-1201	3 X 4 Prongs, Blunt	5¾ in 146 mm	9 in 229mm

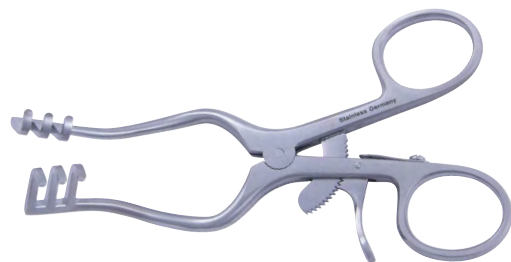

24-2614

Weitlaner-Wullstein Retractor

Arms Angled Downward

CODE	DESCRIPTION	DIMENSIONS
24-2613	3 x 3 Prong, Sharp	5⅛ in 130 mm
24-2614	3 x 3 Prong, Blunt	5⅛ in 130 mm

General Purpose (Self-Retaining)

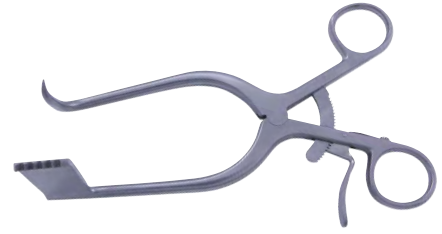

57-2952

Williams Micro Dissectomy Retractor

CODE	DESCRIPTION	DIMENSIONS	TOTAL LENGTH
57-2951	Left Hook	50 x 10 mm	6 in 152 mm
57-2952	Left Hook	50 x 20 mm	6 in 152 mm
57-2961	Left Hook	60 x 10 mm	6 in 152 mm
57-2971	Left Hook	70 x 10 mm	6 in 152 mm
57-2972	Left Hook	70 x 20 mm	6 in 152 mm
57-2851	Right Hook	50 x 10 mm	6 in 152 mm
57-2852	Right Hook	50 x 20 mm	6 in 152 mm
57-2862	Right Hook	60 x 20 mm	6 in 152 mm
57-2871	Right Hook	70 x 10 mm	6 in 152 mm
57-2872	Right Hook	70 x 20 mm	6 in 152 mm

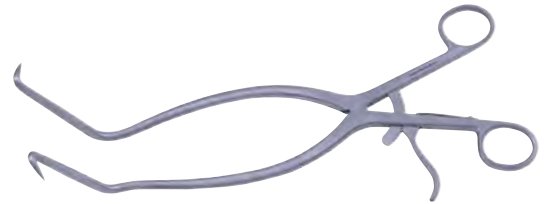

Wiltse-Gelpi Retractor

Deep Blades

CODE	DESCRIPTION	LENGTH
24-4760	1 x 1 Prongs, Sharp	11 in 279 mm

Hysterectomy



50-5566

Heaney Hysterectomy Retractor

CODE	DIMENSIONS (W X D)	DIMENSIONS
50-5566	1 $\frac{1}{8}$ x 2 $\frac{7}{8}$ in 29 x 73 mm	6 $\frac{1}{2}$ in 165 mm
50-5567	1 $\frac{1}{8}$ x 3 $\frac{1}{4}$ in 29 x 82 mm	6 $\frac{1}{2}$ in 165 mm
52-2751	1 x 1 $\frac{3}{4}$ in 25 x 45 mm	6 $\frac{3}{4}$ in 171 mm
52-2752	1 $\frac{1}{8}$ x 2 $\frac{7}{8}$ in 29 x 73 mm	6 $\frac{3}{4}$ in 171 mm
52-2753	1 $\frac{1}{8}$ x 3 $\frac{1}{4}$ in 29 x 85 mm	6 $\frac{3}{4}$ in 171 mm

Hysterectomy

Heaney-Simon Hysterectomy Retractor

CODE	DIMENSIONS (W X L)	
50-5570	1 x 4 ½ in	25 x 114 mm
52-2727	1 x 4 ½ in	25 x 114 mm

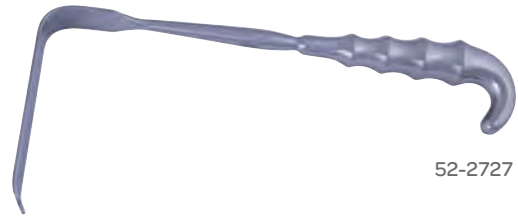

52-2727

Laparoscopic

Fan Retractor

CODE	DESCRIPTION	LENGTH
24-1800	Pressure Lock Handle, 60° Opening 10 mm, 60 mm	9 ½ in 241 mm
32-1800	Pressure Lock Handle, 60° Opening 10 mm, 60 mm	12 ¾ 320 mm
38-1800	Pressure Lock Handle, 60° Opening 10 mm, 60 mm	15 in 381 mm
45-1800	Pressure Lock Handle, 60° Opening 10 mm, 60 mm	17 ¾ 450 mm



24-1800

Fan Retractor

CODE	DESCRIPTION
90-9800	Curved, 5 mm



Hasson "S" Retractor

Set of Two

CODE	WIDTH		LENGTH
90-6003	¼ in	6.3 mm	6 in 152 mm
90-6002	⅜ in	10 mm	6 ¾ in 171 mm
90-6004	½ in	13 mm	6 in 152 mm
90-6008	½ in	13 mm	7 in 177 mm
90-6005	⅜ in	10 mm	7 ⅛ in 180 mm
90-6006	⅝ in	15 mm	7 ⅛ in 180 mm
90-6007	¾ in	19 mm	7 ⅛ in 180 mm

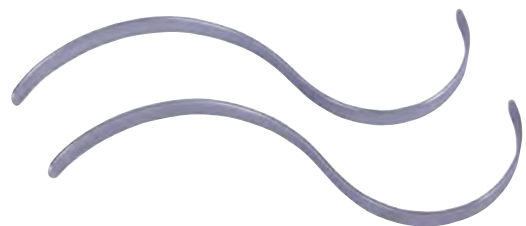

90-6002

Laparoscopic (Bookwalter®)

Bookwalter® Telescopic Laparoscopic Holder

CODE	DESCRIPTION
50-4685	Telescopic with Instrument holder for instruments, trocars and laparoscopic retractors 5 mm - 17 mm.



Bookwalter® Universal Flex Arm System

CODE	DESCRIPTION
50-4805	Bookwalter® Universal Flex Arm System Includes Arm and One Each of the Adapters Below.
50-4806	Ring Adapter For Bookwalter® Flex Arm
50-4807	Lap Instrument Adapter (Spring) For Bookwalter® Flex Arm
50-4808	Camera Lens Adapter For Bookwalter® Flex Arm
50-4809	Camera Housing Adapter For Bookwalter® Flex Arm

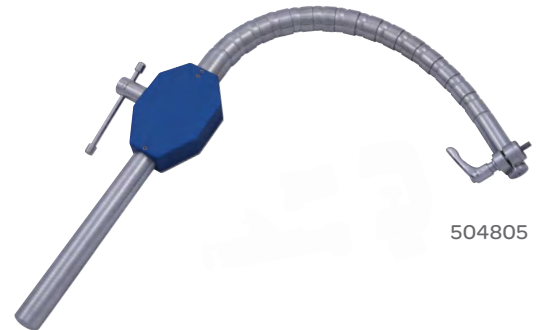

Laparoscopic Support Set

CODE	DESCRIPTION	QTY
50-5730	Laparoscopic Support Set Includes the Following:	
50-4683	Bookwalter® Table Post, 8 in	1
50-4554	Bookwalter® Post Coupling	1
50-4805	Bookwalter® Universal Flex Arm, Includes 4 Adapters Listed Below	1
50-4806	Bookwalter® Flex Arm Ring Adapter	1
50-4807	Bookwalter® Flex Arm Laparoscopic Instrument Adapter	1
50-4808	Bookwalter® Flex Arm Camera Lens Adapter	1
50-4809	Bookwalter® Flex Arm Camera Housing Adapter	1
68-1593	Fan Retractor, 5mm, Articulating, 3 Fingers	1
68-1594	Fan Retractor, 10mm, Articulating, 5 Fingers	1

Lung



50-8153

Allison Lung Retractor

CODE	DESCRIPTION	LENGTH	
50-8152	Adult, Small	10½ in	267 mm
50-8153	Adult, Large	12½ in	318 mm

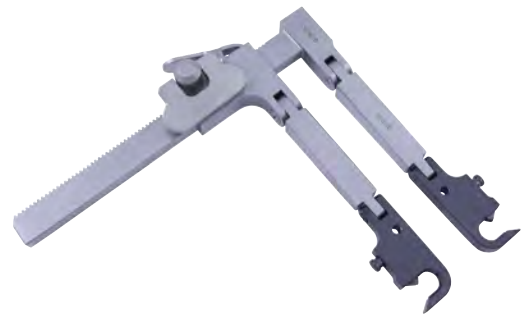

59-0100

Ultra™ Side Loading Retractor

CODE	DESCRIPTION	LENGTH	
59-0101	Longitudinal, Table Mounted, with Double Hinge	14 x 15 in	356 x 381 mm
59-0100	Transverse 4¾ in (120 mm) Rack, Table Mounted, with Double Hinge	2¾ x 2 in	70 x 51 mm



Bookwalter® I.M.A. Crossbar

CODE	DESCRIPTION	LENGTH	
50-4601	Table Mounted, Small	12 in	305 mm

Mastectomy

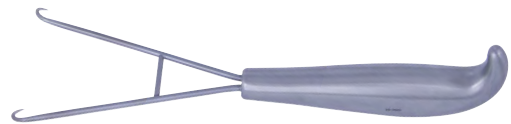

Berens Mastectomy Retractor

CODE	DESCRIPTION	LENGTH	
22-3600	Square	7⅞ in	200 mm

Mouth Gags



72-0515

Sluder Jansen/Schink Mouth Gag

CODE	DESCRIPTION	LENGTH
72-0515	Adult	4 ¼ in 108 mm

Neuro (Flap)



22-2003

Freeman Flap Retractor

CODE	BLADE WIDTH	LENGTH
22-2002	12 mm	8 in 220 mm
22-2003	25 mm	8 in 220 mm

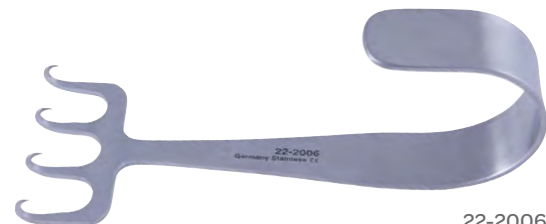

22-2006

Maxwell Flap Retractor

CODE	WIDTH	LENGTH
22-2007	22 mm	4 in 101 mm
22-2006	38 mm	4 in 101 mm

Neuro (Hand-Held)



22-0057

Davis Brain Spatula

Malleable

CODE	DESCRIPTION	LENGTH
22-0057	$\frac{3}{8}$ in 10 mm	7 in 177 mm
22-0070	$\frac{7}{8}$ in 22 mm	8 $\frac{3}{4}$ in 222 mm

Neuro (Lachrymal Sac)



Agricola Lachrymal Sac Retractor

CODE	DESCRIPTION	LENGTH
60-1416	3 x 3 Prong, Sharp	1 $\frac{1}{2}$ in 40 mm

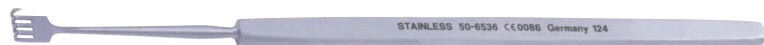

Rollet Lachrymal Sac Retractor

CODE	DESCRIPTION	LENGTH
50-6536	4 Prongs, Sharp	5 $\frac{1}{4}$ in 133 mm



60-1413

Stevenson Lachrymal Sac Retractor

CODE	DESCRIPTION
60-1413	Curved Teeth, 20 mm Spread

Neuro (Posterior Fossa)

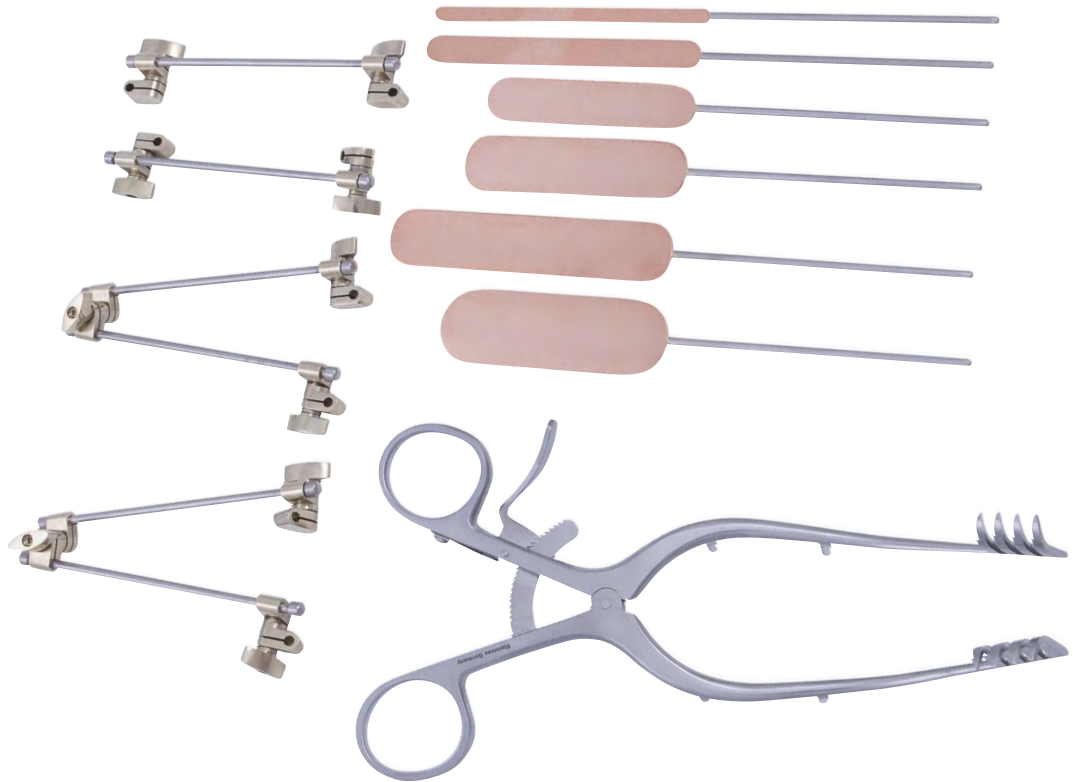

Jannetta Posterior Fossa Retractor

57-9000

CODE	DESCRIPTION	DETAIL	DIMENSIONS	
57-9000	Complete Set Including:			
57-9024	Double Round Bar	3 Swivels	4 in	260 mm
57-9028	Malleable Retractor Blade	15 x 70 mm	6½ in	165 mm
57-9030	Malleable Retractor Blade	20 x 75 mm	6¾ in	171 mm
57-9032	Malleable Retractor Blade	25 x 75 mm	6¾ in	171 mm
57-9034	Malleable Retractor Blade	10 x 95 mm	7½ in	190 mm
57-9036	Malleable Retractor Blade	20 x 95 mm	7½ in	190 mm
57-9038	Malleable Retractor Blade	5 x 95 mm	7½ in	190 mm
57-9022	Retractor Body	with 4 Posts	4 in	100 mm
57-9026	Round Bar	with 2 Swivels	4 in	100 mm

Neuro (Self-Retaining)



Malis® Brain Retractor Kit

Black Anodized, Attaches to the Malis® Cerebellar Retractor (50-1465)

CODE	DESCRIPTION	QTY	LENGTH	WIDTH
50-1460	Includes One Each of the Five Blades and Three Extensions Listed Below:			
	Blade	1	3 in 76 mm	$\frac{3}{8}$ in 10 mm
	Blade	1	3 in 76 mm	$\frac{9}{16}$ in 14 mm
	Blade	1	3 in 76 mm	$\frac{5}{8}$ in 16 mm
	Blade	1	3 in 76 mm	$\frac{3}{4}$ in 19 mm
	Blade	1	3 in 76 mm	$\frac{3}{8}$ in 10 mm
	Retractor Extension	1	2 in 51 mm	
	Retractor Extension	1	3 in 76 mm	
	Retractor Extension	1	4 in 102 mm	
50-1454	Double Connector	2		

Neuro (Greenberg®)



Greenberg® Maxi-Vise Adapter

Double the holding diameter of arms from 4mm to 8mm.
Useful for holding suction devices and other various micro-surgical instruments.

CODE	DESCRIPTION
50-1515	Attaches to the Greenberg® Flexible Arms (50-1509 and 50-1511)

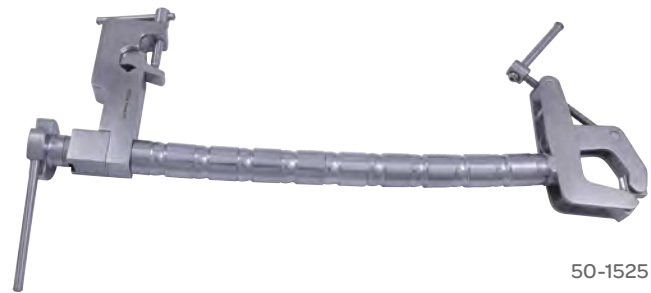

50-1525

Greenberg® Instrument Holder

CODE	DESCRIPTION
50-1523	Small, Holds Shafts Up to $\frac{5}{16}$ in (8mm) In Diameter and Flat Instruments
50-1524	Large, Holds Shafts Up to 1 in (25mm) In Diameter and Flat Instruments
50-1525	Extra Large, Holds Shafts Up to 2 in (51mm) In Diameter and Flat Instruments

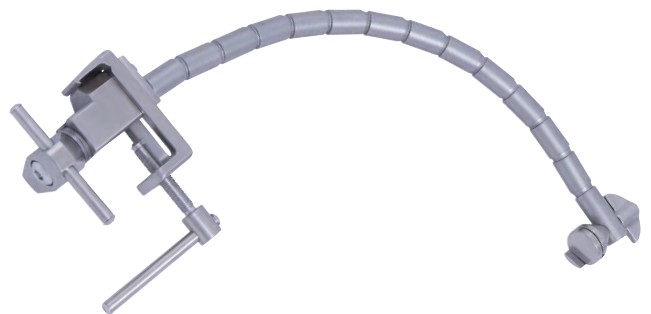

Greenberg® Long Arm

CODE	DESCRIPTION
50-1509	Attaches to Primary or Secondary Bar

Neuro (Greenberg®)



Greenberg® Micro Instrument Holder Collateral Retractor

CODE	DESCRIPTION
50-1529	Flexbar Arm Used to Hold Microinstruments, Holds Up to 1/8 in (3 mm) Diameter



Greenberg® Short

CODE	DESCRIPTION	LENGTH	
50-1511	Attaches to Primary Bar or Secondary Arm	6 1/2 in	165 mm



Greenberg®

CODE	DESCRIPTION	LENGTH	
50-1516	Attaches to Primary Bar or Secondary Arm	12 in	305 mm

Neuro (Greenberg®)



Greenberg® Primary Bar

CODE	DESCRIPTION	LENGTH	
50-1507	Attaches to Skull Clamp	6 in	152 mm



Greenberg® Secondary Bar

CODE	DESCRIPTION	LENGTH	
50-1508	Attaches to Primary Bar	12 in	305 mm



Greenberg® Short Coupler

CODE	DESCRIPTION	LENGTH	
50-1522	Can Be Used as Mount for the Greenberg® Handrest	5½ in	140 mm

Neuro (Greenberg®)



50-1530

Greenberg® Retractor Blade

Tapered

CODE	TAPERED BLADE WIDTH	BLADE LENGTH		
50-1534	$\frac{1}{16} \times \frac{1}{4}$ in	1.6 x 19 mm	9 in	229 mm
50-1533	$\frac{3}{32} \times \frac{3}{8}$ in	2 x 10 mm	9 in	229 mm
50-1532	$\frac{1}{8} \times \frac{1}{2}$ in	3 x 13 mm	9 in	229 mm
50-1531	$\frac{5}{32} \times \frac{5}{8}$ in	4 x 16 mm	9 in	229 mm
50-1530	$\frac{1}{4} \times \frac{3}{4}$ in	6 x 19 mm	9 in	229 mm



Greenberg® Sterilizing Case

Includes Four Compartments for Various Components

CODE	DESCRIPTION	WIDTH		DEPTH		LENGTH	QTY
50-1514	Universal Retractor Case	10 in	254 mm	2 $\frac{1}{8}$ in	60 mm	17 in (432 mm)	1
Compartment Sizes							
	Compartment # 1	7 $\frac{3}{4}$ in	197 mm	10 $\frac{3}{4}$ in	264 mm		
	Compartment # 2	2 $\frac{1}{8}$ in	54 mm	17 in	432 mm		
	Compartment # 3	4 $\frac{5}{8}$ in	117 mm	6 $\frac{3}{4}$ in	171 mm		
	Compartment # 4	3 $\frac{1}{8}$ in	79 mm	6 $\frac{3}{4}$ in	171 mm		

Neuro (Greenberg®)



Greenberg® Hand Rest

CODE	DESCRIPTION	LENGTH	
50-1512	Attaches to Short Coupler (50-1509) or Secondary Bar (50-1508 or 50-1516)	10 in	254 mm



Greenberg® Universal & Handrest Kit

CODE	DESCRIPTION	LENGTH	
50-1500	Universal and Handrest Kit	3½ in	89 mm



Greenberg® Pattie Tray

CODE	DESCRIPTION	LENGTH	
50-1513	Attaches to Long (50-1509) or Short Arm (50-1511)	6¼ in	171 mm

Neuro



Ultra Greenberg® Style Cranial Pattie Tray

CODE	DESCRIPTION	LENGTH
59-7905	Titanium	6¼in 171 mm

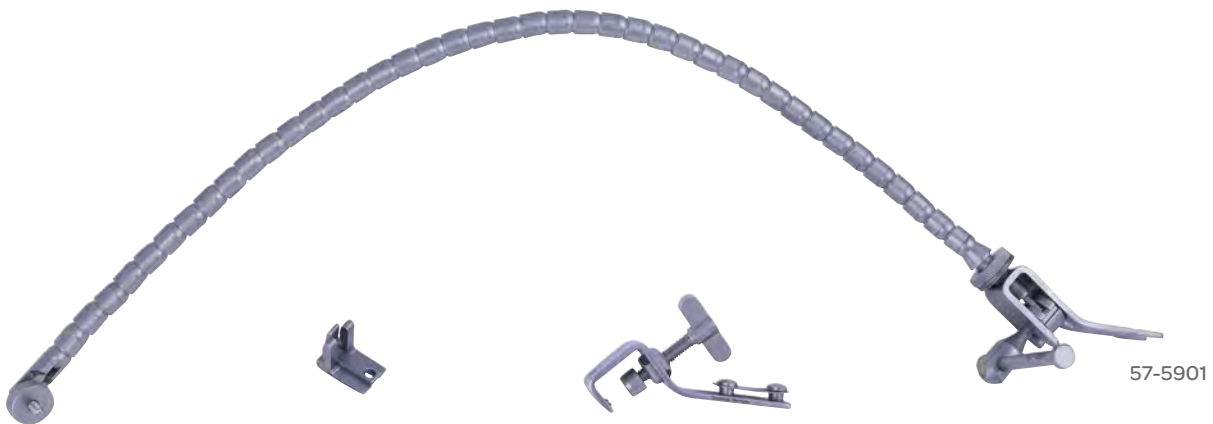

Leyla Brain Retractor

CODE	DESCRIPTION
57-5910	Flexible Tension Arm
57-5941	Rigid Holding Arm
57-5901	Self-Retaining, One Armed
57-5902	Self-Retaining, Two Armed
57-5930	Spatula Support
57-5921	Fixation Base
57-5922	Fixation Base
57-5943	Ball Joint Clamp
57-5942	Coupling Head to Hold Flexible Arms

Neuro



Malis® Double Connector

CODE	DESCRIPTION
50-1454	For Use with 50-1460

RETRACTORS

Ophthalmology (Hand-Held)

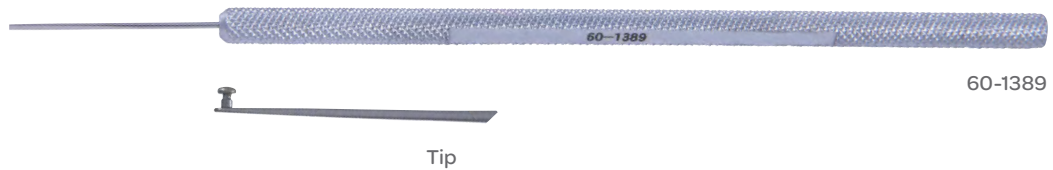

Graether Retractor

Collar Button on Handle

CODE	DESCRIPTION	LENGTH
60-1389	Straight	4 ¾ in 120 mm
60-1390	Angled	4 ¾ in 120 mm

Ophthalmology (Hand-Held)



60-1937

Guyton-Park Speculum

Horizontal Suture Posts

CODE	DESCRIPTION	LENGTH	
60-1937	14 mm Wide, Fenestrated Blades	3 ³ / ₈ in	86 mm
60-1938	14 mm Wide, Solid Blades	3 ³ / ₈ in	86 mm

Ophthalmology (Lens Capsule)



Mackool Lens Capsule Retractor

CODE	DESCRIPTION	LENGTH	
60-1943	1 mm Hook Suspended 0.5 mm From End of Tip, 45° Angled Shaft	4 ³ / ₄ in	120 mm

Ophthalmology (Lid)



60-1404

Desmarres Lid Retractor

CODE	SIZE	WIDTH	LENGTH	
60-1404	Size 0	11 mm	5 ¹ / ₂ in	140 mm
60-1405	Size 1	13 mm	5 ¹ / ₂ in	140 mm
60-1406	Size 2	15 mm	5 ¹ / ₂ in	140 mm
60-1407	Size 3	16 mm	5 ¹ / ₂ in	140 mm
60-1403	Size 4	18 mm	5 ¹ / ₂ in	140 mm

Ophthalmology (Lid)

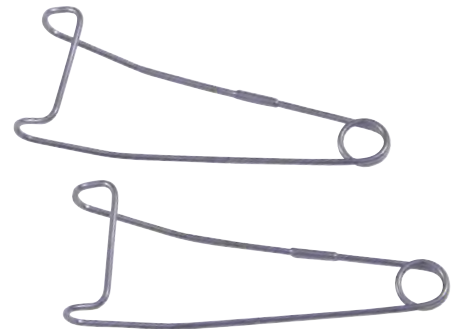

Jaffe Lid Retractor

CODE	WIDTH
60-1408	9 mm Wide



Hardy™ Lip Retractor

CODE
80-1337

Ophthalmology (Orbital)



Schepens Orbital Retractor

CODE	DESCRIPTION	LENGTH
60-5008	Smooth 14 x 57 mm, Blade with Notched End, 4.5 mm Wide Notch	6 in 152 mm

Ophthalmology (Orbital)



63-4003

Sewall Orbital Retractor

CODE	BLADE	LENGTH
63-4003	7x52 mm	6 ³ / ₄ in 170 mm
63-4004	9x51 mm	6 ³ / ₄ in 170 mm
63-4005	11x50 mm	6 ³ / ₄ in 170 mm

Ophthalmology (Self-Retaining)



60-2003

Lieberman Open Wire Speculum

CODE	DESCRIPTION	DIMENSION
60-2003	K-Wire, Open Blades	17 mm
60-2004	V-Wire, Open Blades	17 mm
60-2005	Closed Blades	8 ¹ / ₂ in

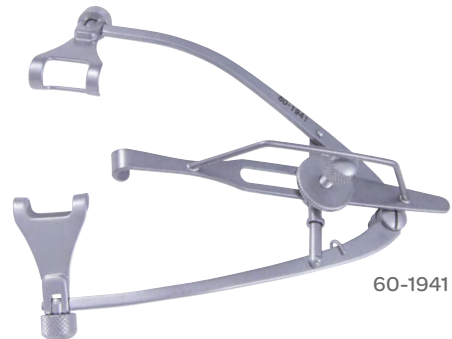

60-1941

Maumenee-Park Speculum

Fenestrated Blades

CODE	BLADE SPREAD	BLADE WIDTH	LENGTH
60-1941	43 mm	14 mm	3 ¹ / ₄ in 83 mm

Orthopaedic (Bones)



77-1240

Aufranc Cobra Retractor

CODE	DESCRIPTION	LENGTH	
77-1242	10 mm, Serrated Blunt Tip	10 ½ in	265 mm
77-1240	10 mm, Serrated Pointed Tip	10 ½ in	265 mm
77-1243	10 mm, Smooth Blunt Tip	10 ½ in	265 mm
77-1241	10 mm, Smooth Pointed Tip	10 ½ in	265 mm



Aufricht Retractor

CODE	DESCRIPTION	LENGTH	
67-2137FO	7 mm Wide, with Fiber Optic Light Guide and Suction		5 x 95 mm



77-1204

Bennett Bone Retractor

CODE	WIDTH	LENGTH	
77-1204	45 mm	9 ½ in	240 mm
77-1206	65 mm	9 ½ in	240 mm



Capsule Retractor

CODE	DESCRIPTION	LENGTH	
77-1005	3 Prong, Sharp, 22 mm Wide	10 in	250 mm

Orthopaedic (Bones)



Cobra Retractor

37-4106

CODE	DESCRIPTION	TIP	
37-4106	Blunt	10 ¼ in	260 mm
37-4105	Sharp	10 ¼ in	260 mm



77-1050

Hohmann Mini Retractor

CODE	WIDTH	LENGTH	
77-1050	6 mm	6 ¼ in	160 mm
77-1052	8 mm	6 ¼ in	160 mm



77-1240

Hohmann Retractor

CODE	DESCRIPTION	LENGTH	
77-1122	15 mm Wide, without Finger Ring	6 in	150 mm
77-1008	8 mm Wide with Finger Ring	8 ½ in	215 mm
77-1110	10 mm Wide with Finger Ring	8 ¾ in	220 mm
77-1120	16 mm Wide with Finger Ring	9 ½ in	240 mm
77-1118	18 mm Wide with Finger Ring	9 ½ in	240 mm
77-1167	22 mm Wide with Finger Ring	11 in	280 mm
77-1124	24 mm Wide, with Finger Ring	9 ½ in	240 mm
77-1125	25 mm Wide with Finger Ring	9 ½ in	240 mm
77-1142	42 mm Wide with Finger Ring	9 ½ in	240 mm
77-1165	62 mm Wide with Finger Ring	10 in	250 mm



Murphy-Lane Bone Retractor

CODE	LENGTH
77-1193	12 in 304 mm

Ophthalmology (Hand)



20-1776

Hayes Hand Retractor

CODE	WIDTH	LENGTH	
20-1776	3 mm	6 ¼ in	160 mm
20-1777	6 mm	6 ¼ in	160 mm



House Hand Retractor

CODE	DESCRIPTION	LENGTH	
61-0600	Hand Retractor	6 in	150 mm



Kasdan Hand Retractor

CODE	DESCRIPTION	LENGTH	
20-0540	Double-Ended	6 ¼ in	160 mm

Orthopaedic (Hand-Held)



McElroy Angulated Retractor

CODE	DESCRIPTION	LENGTH	
77-1191	T-Handle Retractor, 5 in (120 mm) Blade Depth	7 in	178 mm

Orthopaedic (Hip)

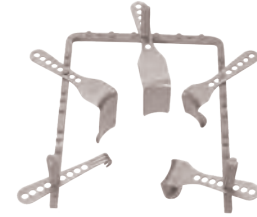

30-038-000

Complete Charnley Retractor Set

CODE	DESCRIPTION	QTY
30-038-000	Charnley Retractor Set, Includes the Following:	
13-045-008	Standard Charnley Retractor Frame	1
13-045-001	Standard Charnley Retractor	2
13-045-002	Large Standard Charnley Retractor	2
13-045-003	Serrated Charnley Retractor Blade	2
13-045-004	Threaded Locking Screw	6
13-045-000	Optional Frame: Small Charnley Retractor Frame	1



30-034-000

Complete Hip Retractor System

CODE	DESCRIPTION
30-034-000	Hip Retractor System, includes the following:
13-023-000	Hip Retractor, 25 mm Blade Part
13-024-000	Hip Retractor, Blunt Tip
13-025-000	Offset Retractor, 32 mm Blade
13-026-000	Long Hohmann
13-027-000	Long Hohmann, Curved, Short Blade
13-028-000	Long Hohmann, Curved, Long Blade
13-029-000	Small Hohmann
13-031-000	Femoral Elevator
11-078-000	Hybrid Case



Blount Hip Retractor

77-1251

CODE	DESCRIPTION	LENGTH
77-1251	Single Prong	10 in 250 mm
77-1252	Double Prong	10 in 250 mm

Orthopaedic (Hip)

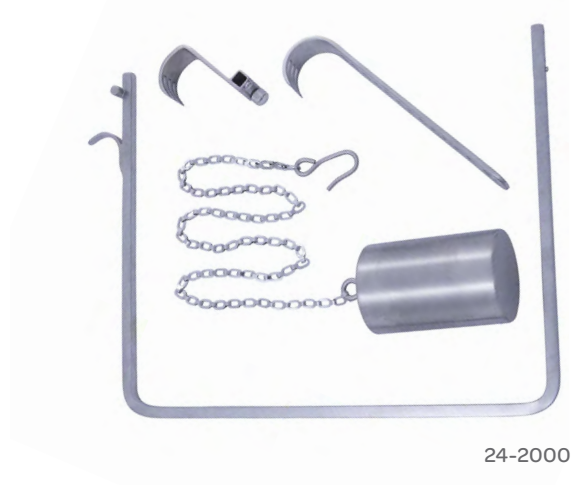

Charnley Initial Incision Retractor

24-2000

CODE	DESCRIPTION
24-2000	Complete set
24-2000C	Chain
24-2000CW	Chain with Weight



Charnley Retractor Blade

CODE	DESCRIPTION	LENGTH	DEPTH
24-2019A	Short Angled	1 in	1 in
24-2014	Short Angled	1 in	2 in
24-2004A	Short Angled	1 in	2½ in
24-2022A	Short Angled	1 in	3 in
24-2009A	Short Angled	1 in	4 in
24-2010A	Long Angled	1 in	4 in
24-2005A	Long Angled	1 in	2½ in
24-2016A	Long Angled	1 in	3 in
24-2010A	Long Angled	1 in	4 in
24-2012	Short Rounded	1 in	¼ in
24-2004	Short Rounded	1 in	2½ in
24-2009	Short Rounded	1 in	4 in
24-2009M	Short Rounded	1 in	6 in
24-2011	Long Rounded	1 in	1½ in
24-2017	Long Rounded	1 in	1½ in
24-2005	Long Rounded	1 in	2½ in
24-2010	Long Rounded	1 in	4 in

Orthopaedic (Hip)



13-023-000

Minimally Invasive Hip Retractor

CODE	SIZE	DESCRIPTION
13-023-000	#1, Curved	25 mm Blade Pointed Tip
13-024-000	#2, Curved	Blunt Tip
13-025-000	#3, Offset	32 mm Blade
13-026-000	#4	Long Hohmann
13-027-000	#5	Long Hohmann, Short Curved Blade
13-029-000	#7	Long Hohmann, Narrow Blade
13-030-000	#8	Small Hohmann

Orthopaedic (Hip & Shoulder)



Meyerding Hip & Shoulder Skid

CODE	LENGTH
77-1190	13 in 329 mm

Orthopaedic (Humeral)



Bristow-Bankart Humeral Retractor

CODE	DESCRIPTION	DIMENSIONS
77-1011	2 Prong, Blunt	25 x 102 mm

Orthopaedic (Humeral Head)



Humeral Head Retractor

CODE	WIDTH	LENGTH
77-1013	18 mm	8 ¾ in 200 mm

Orthopaedic (Knee)



13-035-000

Minimally Invasive Knee Retractor

CODE	SIZE	DESCRIPTION
30-032-000		System includes the following:
13-035-000	#1	Small Hohmann
13-036-000	#2	Large Hohmann
13-037-000	#3	Condylar Retractor
13-038-000	#4	Superior Retractor
13-039-000	#5	Patellar Retractor
13-040-000	#6	Collateral Retractor, Left
13-041-000	#7	Collateral Retractor, Right
13-042-000	#8	Soft Tissue Retractor



Worland PCL Retractor

CODE	DESCRIPTION	LENGTH
13-001-000	13 mm Tip	12 ½ in 316 mm

Orthopaedic (Knee)



78-5998

Doane "Z" Knee Retractor

CODE	DESCRIPTION	DIMENSIONS	LENGTH
78-5998	Double-Ended	11 x 57 x 69 mm	152 mm
78-5999	Double-Ended	11 x 63 x 76 mm	152 mm



77-1189

Hohmann Knee Retractor

CODE	DESCRIPTION	LENGTH
77-1189	Up 90°	16 in 405 mm
77-1188	Up 120°	16 in 405 mm



77-5621

Smillie Knee Retractor

CODE	DESCRIPTION W X D	LENGTH
77-5610	13 x 18 mm	5 ½ in 140 mm
77-5611	13 x 25 mm	5 ½ in 140 mm
77-5621	13 x 55mm, Double Curved	5 ½ in 140 mm
77-5601	19 x 30 mm	5 ½ in 140 mm
77-5602	19 x 45 mm	5 ½ in 140 mm
77-5603	19 x 60 mm	5 ½ in 140 mm

Orthopaedic (Shoulder)



Fukuda Shoulder Retractor

77-1006

CODE	DESCRIPTION	LENGTH	
77-1006	38 x 81 mm	7 in	178 mm
77-1007	32 x 81 mm	7 in	178 mm

Plastic Surgery (Brow Lift)



22-2008

Corneal Brow Lift Retractor

CODE	DESCRIPTION	LENGTH	
22-2008	7 Prong	7 in	178 mm
20-2010	7 Prong, Sharp	7 in	178 mm

Plastic Surgery (Hand)



Tip



20-6103

Plastic/Hand Surgery Retractor

CODE	DESCRIPTION	LENGTH	
20-6101	1 Prong, Blunt	6¾ in	170 mm
20-6102	2 Prong, Blunt	6¾ in	170 mm
20-6103	3 Prong, Blunt	6¾ in	170 mm
20-6104	4 Prong, Blunt	6¾ in	170 mm

Plastic Surgery (Hand)



Tip



20-6004

Plastic/Hand Surgery Retractor

CODE	DESCRIPTION	WIDTH	LENGTH
20-6001	1 Prong, Sharp	9 mm	6 ³ / ₄ in 170 mm
20-6002	2 Prong, Sharp	5 mm	6 ³ / ₄ in 170 mm
20-6003	3 Prong, Sharp	8 mm	6 ³ / ₄ in 170 mm
20-6004	4 Prong, Sharp	11 mm	6 ³ / ₄ in 170 mm

Plastic Surgery (Hand-Held)



Anderson Bear Claw Retractor

CODE	DESCRIPTION	LENGTH
22-2005	5 Prong	4 ³ / ₄ in 120 mm

Prostatic



51-9503

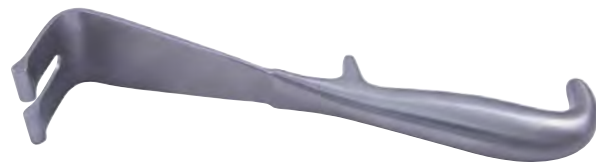

51-9504

Young Prostatic Retractor

CODE	DESCRIPTION	DIMENSIONS	LENGTH
51-9501	Lateral Notched Blade	⁷ / ₁₆ x 2 in 11 x 50 mm	8 ¹ / ₄ in 210 mm
51-9503	Notched Blade	1 x 1 in 25 x 25 mm	8 ¹ / ₄ in 210 mm
51-9504	Bifurcated Blade	1 ³ / ₄ x 1 ¹ / ₂ in 44 x 38 mm	8 ¹ / ₄ in 210 mm

Rectal (Hand-Held)



Barr Anal Retractor

CODE	DESCRIPTION	DIMENSIONS	LENGTH
50-7325	Self-Retaining with Blades	2 3/4 x 7/8 in 70 x 22 mm	8 in 200 mm

Rectal (Self-Retaining)



50-7615

Brinkerhoff Rectal Speculum

CODE	DESCRIPTION	DIMENSIONS	LENGTH
50-7613	Small	1/2 in x 1 in 12 x 25 mm	4 1/2 in 114 mm
50-7615	Medium	5/8 x 1 in 15 x 25 mm	4 1/2 in 114 mm
50-7619	Large	3/4 x 1 1/4 in 19 x 31 mm	4 1/2 in 114 mm

Rectal (Bookwalter®)

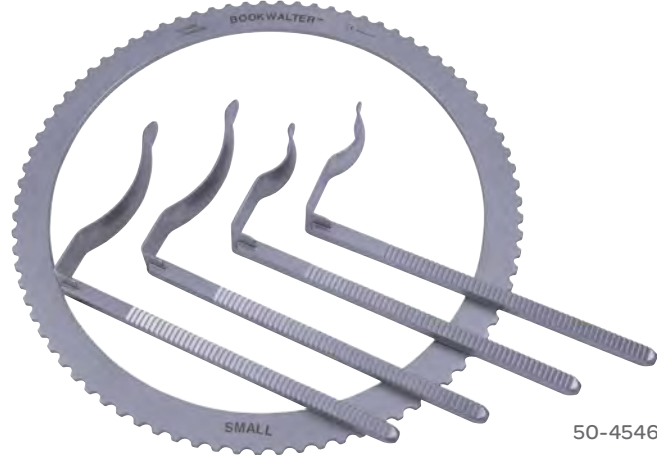

Bookwalter® Rectal Accessory Kit

Kit Includes: 1 Ring and 2 Blades

50-4546

CODE	DESCRIPTION	DIAMETER	BLADE	DIMENSIONS
50-4546	Kit Includes the Following:			
50-4584	Bookwalter® Round Rings, Small	8½ in 216 mm		
50-4585	Bookwalter® Rectal Blade, Small		2⅞ in 73 mm	3 x 7 in 76 x 178 mm
50-4586	Bookwalter® Rectal Blade, Large		3⅞ in 98 mm	4 x 6 in 101 x 152 mm

Note: Use of this product requires a Bookwalter® Table Post, Bookwalter® Coupler, Bookwalter® Horizontal Bar, and Bookwalter® Ratchet (not included in this accessory set.)

Rectal



50-9604

Hill-Ferguson Rectal Retractor

CODE	DIMENSIONS	LENGTH
50-9604	⅞ x ¼ in 22 x 6 mm	8 in 200 mm
50-9605	⅞ x 3 in 3 x 76 mm	8½ in 215 mm
50-9606	3 x 1⅜ in 76 x 35 mm	8½ in 215 mm
50-9607	1½ in 38 mm	8½ in 215 mm

Rectal



50-9621

Sawyer Retractor

CODE	DESCRIPTION	BLADE DIMENSIONS		LENGTH	
50-9621	Retractor	1 $\frac{1}{8}$ x 3 in	28 x 76 mm	11 in	280 mm
50-9622	Retractor	1 $\frac{1}{2}$ x 3 $\frac{1}{2}$ in	38 x 89 mm	11 in	280 mm

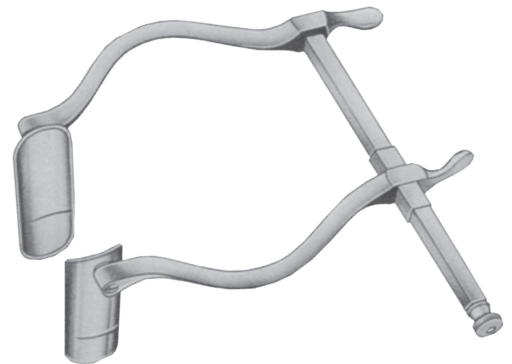

Smith-Buie Rectal Retractor

CODE	DESCRIPTION	LENGTH
50-7420	Self-Retaining, with Swivel Blades	4 $\frac{1}{2}$ in 115 mm

Redundant Wall



Redundant Wall Retractor

CODE	DESCRIPTION	BLADE DIMENSIONS	
52-0790	Wall Retractor	3 $\frac{3}{4}$ x 5 in	19 x 127 mm

Renal (Sinus)



5150-D

Gilvernet Renal Retractor

CODE	DESCRIPTION	LENGTH	CODE	DESCRIPTION	LENGTH
5150-A	9 mm	11¼ in 286 mm	5150-C	15 mm	11¼ in 285 mm
5150-B	11 mm	11¼ in 286 mm	5150-D	18 mm	11¼ in 285 mm

Renal (Vein)



54-1795

Wylie Renal Retractor

CODE	DESCRIPTION	BLADE WIDTH
54-1795	Renal Retractor	1 x 4 in 25 x 102 mm
54-1797	Renal Retractor	1 x 7 in 25 x 178 mm

Renal



58-0084

Universal Ring Wiley Renal Retractor Blade

CODE	DESCRIPTION	DIMENSIONS
58-0084	Renal Retractor Blade	1 x 7 in 25 x 178 mm
58-0084L	Renal Retractor Blade	1 x 11 in 25 x 279 mm

Rib (Self-Retaining)

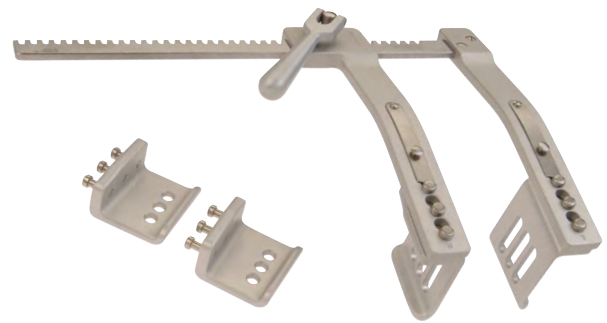

50-8033

Burford-Finochietto Rib Retractor

CODE	DESCRIPTION	TOTAL OPENING		BLADE	ARM LENGTH		LENGTH	
50-8133	Child Model, Self Retaining with Rack and Pinion Action, Aluminum	6 in	152 mm	Large: $1\frac{5}{8} \times 1\frac{7}{8}$ in 41 x 48 mm Small: $1\frac{5}{8} \times 1\frac{3}{8}$ in 41 x 35 mm	6 in	152 mm	6 in	152 mm
50-8033	Self-Retaining, Two Sets of Detachable Blades, Curved Arms	10 in	254 mm	Large: $2\frac{1}{2} \times 2\frac{5}{8}$ in 64 x 67 mm Small: $2\frac{1}{2} \times 1\frac{3}{4}$ in 64 x 44 mm	$9\frac{1}{2}$ in	241 mm	10 in	254 mm
50-8031	Self-Retaining, Two Sets of Detachable Blades, Curved Arms	10 in	254 mm	Large: $2\frac{1}{2} \times 2\frac{4}{5}$ in 64 x 71 mm Small: $2\frac{1}{2} \times 1\frac{3}{5}$ in 64 x 41 mm	$9\frac{3}{4}$ in	248 mm	10 in	254 mm

Rib

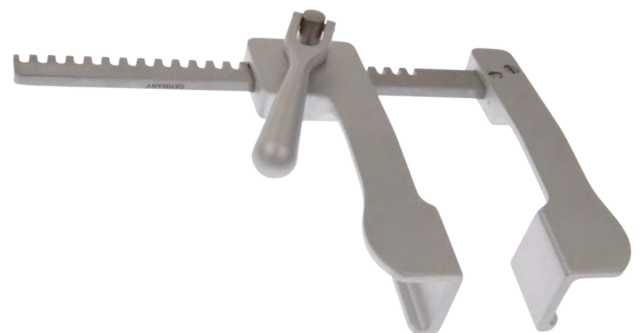

54-2101

Cooley Rib Retractor

Aluminum Arms and Blades

CODE	DESCRIPTION	BLADE LENGTH		BLADE DEPTH		SPREAD		ARM LENGTH	
54-2101	Pediatric	1 in	25 mm	$\frac{5}{8}$ in	16 mm	$4\frac{3}{4}$ in	121 mm	$3\frac{1}{8}$ in	79 mm
54-2100	Adult	$1\frac{3}{8}$ in	35 mm	$1\frac{3}{8}$ in	35 mm	7 in	178 mm	$4\frac{1}{4}$ in	108 mm

Rib



Finochietto Rib Retractor

Self-Retaining with Rack and Pinion Action

50-5625

CODE	DESCRIPTION	TOTAL OPENING	BLADE (W X D)	ARM LENGTH	LENGTH
50-5625	Infant	2½ in 64 mm	¾ x 1⅜ in 19 x 30 mm	3 in 76 mm	2½ in 64 mm
50-8022	Pediatric	6½ in 165 mm	1¾ x 1¾ in 44 x 44 mm	6 in 152 mm	6 in 152 mm



Haight-Finochietto Rib Retractor

Self-Retaining with Rack and Pinion Action

CODE	DESCRIPTION	TOTAL OPENING	BLADE (W X D)	ARM LENGTH	LENGTH
50-8028	Rib Retractor	4 in 102 mm	1¼ x 1⅜ in 32 x 30 mm	3¼ in 83 mm	4 in 102 mm

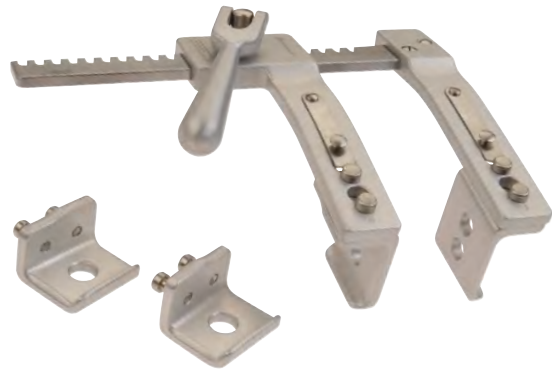

Rib Retractor

Infant, Self-Retaining with Rack and Pinion Action, Aluminum

CODE	ARM LENGTH	BLADE WIDTH	BLADE DEPTH	LENGTH
50-5625	3 in 76 mm	¾ in 19 mm	⅜ in 21 mm	2½ in 64 mm

Rib



50-8065

Tuffier Rib Retractors

Self-Retaining

CODE	DESCRIPTION	LENGTH	
50-8065	Roughened Blades	3 x 2 1/2 in	76 x 64 mm
50-8064	Serrated Blades	4 3/4 x 6 in	146 x 152 mm

Scalp



Anderson-Adson Scalp Retractor

Angular Arms

CODE	DESCRIPTION	BLADE WIDTH		BLADE DEPTH		TOTAL OPENING		LENGTH
50-1186	4 x 4 Sharp Prongs	3/4 in	19 mm	5/8 in	16 mm	4 1/2 in	114 mm	7 1/2 in 191 mm

Scalp

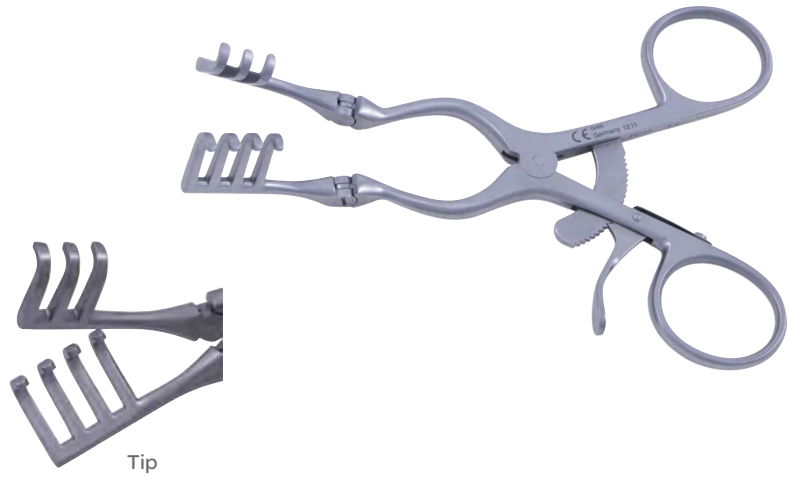

Cone Scalp Retractor

CODE	DESCRIPTION	LENGTH
50-1166	Self-Retaining with Hinged Arms, 3 x 4 Prong, Blunt	5 ¾ in 146 mm



24-2670

Contour Scalp Retractor

CODE	DESCRIPTION	LENGTH
24-2670	Angled Arms, 3 x 4 Prong, Blunt	5 ½ in 139 mm
24-2671	Angled Arms, 3 x 4 Prong, Sharp	5 ½ in 139 mm
50-1220	5/8 x 5/8 in, Total Opening 2 ½ in	5 ½ in 139 mm

Scalp



24-1310

Jansen Scalp Retractor

CODE	DESCRIPTION	LENGTH	
24-1310	3 x 3 Prong, Sharp	4 in	100 mm
24-1320	3 x 3 Prong, Blunt	4 in	100 mm
24-1321	4 x 4 Prong, Blunt	4 $\frac{3}{8}$ in	112 mm
50-1226	4 x 4 Prong, Blunt, Self Retaining	4 $\frac{5}{8}$ in	117 mm

Scapula

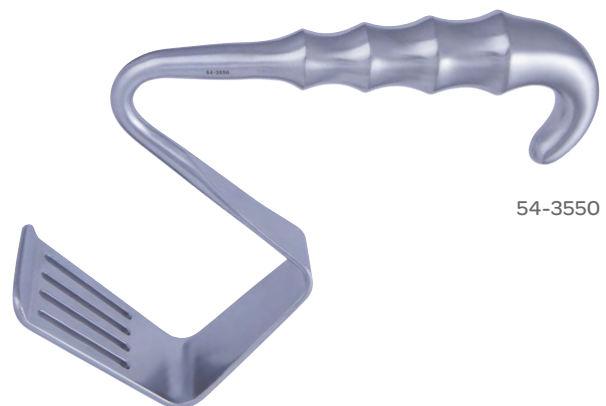

54-3550

Davidson Scapular Retractor

CODE	HANDLE LENGTH		BLADE WIDTH		BLADE DEPTH	
54-3550	6 in	152 mm	2 in	51 mm	3 in	76 mm
50-8096	6 in	152 mm	3 $\frac{1}{2}$ in	89 mm	3 in	76 mm

Septum



79-7011

Killian Septum Specula & Killian Septum Speculum

Self-Retaining

CODE	BLADES	LENGTH
79-7011	51 mm	5 ¼ in 133 mm
79-7012	63 mm	5 ¼ in 133 mm
79-7013	76 mm	5 ¼ in 133 mm
63-6265	51 mm	6 in 152 mm
63-6266	64 mm	6 in 152 mm
63-6267	76 mm	6 in 152 mm
63-6268	90 mm	6 in 152 mm

Spine (Crockard™)



Crockard™ Transoral Instrument Case

CODE	DIMENSIONS
50-1664	18 x 10 ½ x 7 ¼ in 457 x 266 x 184 mm

Spine (Crockard™)



Crockard™ Transoral Instrument Set

CODE	DESCRIPTION	QTY
50-1651	1 Crockard™ Transoral Retractor Body	1
50-1652	1 Large Tongue Retractor Blade	1
50-1653	1 Small Tongue Retractor Blade	1
50-1654	2 Crockard™ 90 Degree Retractor Blade	2
50-1655	2 Crockard™ Curved Retractor	2
50-1656	2 Crockard™ Connector Blades	2
50-1657	1 Crockard™ Suction Tube Short	1
50-1658	1 Crockard™ Suction Tube Long	1
50-1659	1 Crockard™ Hard Palate Retractor	1
50-1660	1 Pharyngeal Retractor Small	1
50-1661	1 Pharyngeal Retractor Large	1
50-1662	1 Crockard™ Odontoid Peg Grasping Forceps	1
50-1663	1 Crockard™ Ligament Grasping Forceps	1
50-1664	1 Crockard™ Sterilizing and Storage Case	1

Spine (Crockard™)



Crockard™ Hard Palate Retractor

CODE	DESCRIPTION	LENGTH
50-1659	Hard Palate Retractor	90 x 75 mm



Crockard™ Mid-Facial Osteotomy Retractor Plate

CODE	DESCRIPTION	LENGTH
50-1668	Mid-Facial Osteotomy Retractor Plate	6 in 152 mm



50-1660

Crockard™ Pharyngeal Retractor

CODE	DESCRIPTION
50-1660	Small
50-1661	Large

Spine (Cervical)

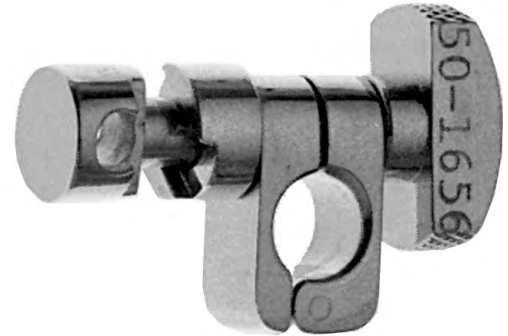

Crockard™ Pharyngeal Retractor

CODE	DESCRIPTION
50-1656	Crockard™ Retractor Blade Connector



50-1657

Crockard™ Suction Tube Holder

CODE	DESCRIPTION
50-1657	Short
50-1658	Long



50-1653

Crockard™ Tongue Retractor Blade

CODE	DESCRIPTION
50-1653	Small
50-1652	Large

Spine (Cervical)



Crockard™ Transoral Retractor Body

CODE	DESCRIPTION
50-1651	Transoral Retractor Body



Cervical Retractor Set

CODE	DESCRIPTION	LENGTH
50-1390	Small, Self-Retaining with 7 Pairs of Blunt Blades	6 x 3 3/4 in 152 x 95 mm



Cervical Retractor

CODE	DESCRIPTION	LENGTH
50-1380	Large, Self-Retaining with Seven Pairs of Sharp Blades Total Opening: 4 1/2 in (114mm)	10in 254mm
57-5660	Hinged Frame, 90 mm Spread	
57-5662	Hinged Frame Only, Hinged Arms, 90 mm Spread	
57-5661	Hinged Frame Only, Rigid Arms	
57-5659	Rigid Frame	
57-5550	One Prong, Blunt	

Spine (Cervical)



50-1383

Cervical Retractor Blade

Sharp, Four Prong, for use with 50-1380

CODE	DESCRIPTION
50-1381	25 mm Blade
50-1382	30 mm Blade
50-1383	35 mm Blade
50-1384	40 mm Blade
50-1385	45 mm Blade
50-1386	50 mm Blade
50-1387	55 mm Blade



50-1392

Cervical Retractor Blade

Blunt, for use with 50-1390

CODE	DESCRIPTION
50-1391	25 mm
50-1392	30 mm
50-1393	35 mm
50-1394	40 mm
50-1395	45 mm
50-1396	50 mm
50-1397	55 mm

Spine (Cervical)



57-5511

Cervical Retractor Blades, Medial with Teeth

Carbon Fiber Radiolucent Blades, Ball Snap Closure, for Use with Cervical Retractors: 57-5659, 57-5660, 57-5661 and 57-5662.

CODE	DESCRIPTION
57-5510	40 x 23 mm
57-5511	45 x 23 mm
57-5512	50 x 23 mm
57-5513	55 x 23 mm
57-5514	60 x 23 mm
57-5515	65 x 23 mm

Cervical Retractor Blades, Lateral with Teeth

Carbon Fiber Radiolucent Blades, Ball Snap Closure

CODE	DESCRIPTION
57-5516	40 x 23 mm
57-5517	45 x 23 mm
57-5518	50 x 23 mm
57-5520	55 x 23 mm
57-5521	60 x 23 mm
57-5519	65 x 23 mm

Spine (Cervical)



57-5523

Cervical Retractor Blades, Longitudinal Blades, Blunt

Carbon Fiber Radiolucent Blades, Ball Snap Closure

CODE	DESCRIPTION
57-5522	40 x 23 mm
57-5523	45 x 23 mm
57-5524	50 x 23 mm
57-5525	55 x 23 mm
57-5526	60 x 23 mm
57-5527	65 x 23 mm



57-5530

Cervical Retractor Blades

Stainless Steel, Ball Snap Closure, Longitudinal Blades, Blunt

CODE	DESCRIPTION
57-5530	40 x 23 mm
57-5531	45 x 23 mm
57-5532	50 x 23 mm
57-5533	55 x 23 mm
57-5534	60 x 23 mm

Cervical Retractor Blades

Stainless Steel, Ball Snap Closure, Fenestrated Blades, Blunt

CODE	DESCRIPTION
57-5535	50 x 25 mm
57-5536	60 x 25 mm

Spine (Cervical)



57-5665

Cervical Retractor Blade

Stainless Steel, Ball Snap Closure, for use with 57-5759, 57-5760, 57-5761 and 57-5762

CODE	DESCRIPTION
57-5665	Medial Blades with Teeth 40 x 23 mm
57-5666	Medial Blades with Teeth 45 x 23 mm
57-5667	Medial Blades with Teeth 50 x 23 mm
57-5668	Medial Blades with Teeth 55 x 23 mm
57-5669	Medial Blades with Teeth 60 x 23 mm
57-5665L	Lateral Blades with Teeth 40 x 23 mm
57-5666L	Lateral Blades with Teeth 45 x 23 mm
57-5667L	Lateral Blades with Teeth 50 x 23 mm
57-5668L	Lateral Blades with Teeth 55 x 23 mm
57-5669L	Lateral Blades with Teeth 60 x 23 mm



50-1356

Cervical Retractor Body

CODE	DESCRIPTION
50-1356	Small
50-1346	Large

Spine (Cervical)



Cervical Retractor

CODE	DESCRIPTION	LENGTH
57-5602	Double-Hinge Retractor	45 x 23 mm

Spine (Decompression)



Cushing Decompression Retractor

57-5205

CODE	DESCRIPTION	LENGTH
57-5205	Fenestrated	8 in 203 mm

Spine (Dural)



90° Dural Suction Retractor

46-3012

CODE	WORKING DISTANCE	TIP WIDTH	TIP DEPTH
46-3012	4 ³ / ₄ in 120 mm	⁹ / ₃₂ in 8 mm	¹ / ₄ in 6 mm
46-3013	4 ³ / ₄ in 120 mm	³ / ₈ in 9.5 mm	¹ / ₄ in 6 mm
46-3014	5 ³ / ₄ in 146 mm	¹ / ₄ in 6 mm	¹ / ₄ in 6 mm
46-3015	5 ³ / ₄ in 146 mm	³ / ₈ in 9.5 mm	¹ / ₄ in 6 mm

Spine (Dural)

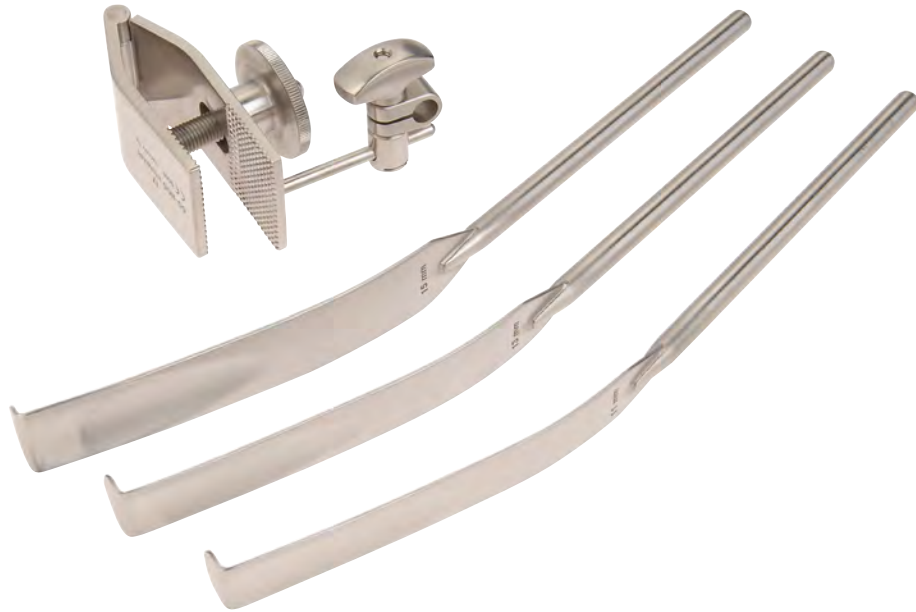

Dural Retractor

CODE	DESCRIPTION	LENGTH
50-1105	Self-Retaining with Three Malleable Blades, 4 in 102 mm Blade Widths: 11 mm, 13 mm, 15 mm	8¼ in 210 mm

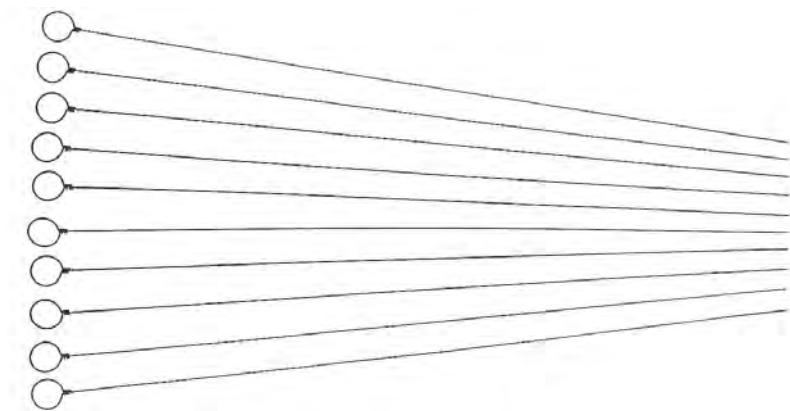

Wire Styles

CODE	DESCRIPTION
46-4000	Used with Dural Suction Retractors for Cleaning and Storage

Spine (Hand-Held)



Blade Retractor With Lip

57-5498

Add "M" to Code Number for Blade without Lip

CODE	DESCRIPTION	LENGTH	
57-5497	13 mm	7½ in	191 mm
57-5498	18 mm	7½ in	191 mm
57-5499	20 mm	7½ in	191 mm
57-5500	23 mm	7½ in	191 mm



63-4017

Converse Blade Retractor

CODE	DESCRIPTION	LENGTH	
63-4017	9 x 18 mm	3¾ in	95 mm
63-4018	12 x 21 mm	3¾ in	95 mm
63-4019	12 x 38 mm	3¾ in	95 mm
63-4020	12 x 53 mm	3¾ in	95 mm

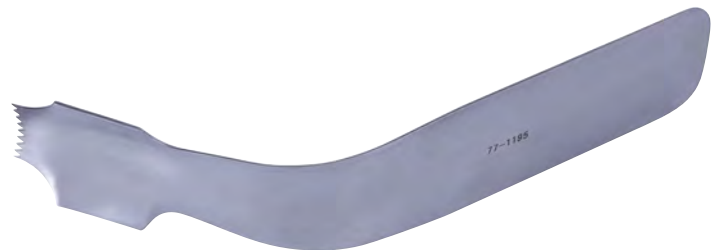

Goldstein Neck Retractor

CODE	DESCRIPTION	LENGTH	
77-1195	Neck Retractor	8½ in	215 mm

Spine (Hand-Held)



50-1085

Taylor Spinal Retractor

CODE	DESCRIPTION	DIMENSIONS	
57-5407	32 x 75mm	6 ³ / ₄ in	171 mm
57-5408	20 x 75mm	6 ³ / ₄ in	171 mm
57-5410	32 x 100mm	6 ³ / ₄ in	171 mm
57-5413	31 x 152mm	6 ³ / ₄ in	171 mm
50-1085	30 x 76mm	7 ¹ / ₄ in	184 mm
50-1086	32 x 102mm	7 ¹ / ₄ in	184 mm

Spine (Hand-Held Retractor Set)



Sofield Hand Held Retractor Set

CODE	DESCRIPTION	BLADE LENGTH	HANDLE LENGTH	
32-3660	Double-Ended, Set of 6			
32-3667		Clip	5 in	127 mm
32-3666		114 x 13mm	7 ¹ / ₂ in	191mm
32-3665		102 x 19mm	8 in	203mm
32-3664		89 x 16mm	8 ¹ / ₁₆ in	204mm
32-3662		70 x 13mm	8 ¹ / ₈ in	206mm
32-3661		63 x 13mm	8 ¹ / ₄ in	210mm

Spine (Hemilaminectomy)



Valin Hemilaminectomy Retractor Set

Self-Retaining with Rack and Pinion Action

CODE	DESCRIPTION	TOTAL OPENING	
50-1120	Includes the Following: 50-1121: Body, 13-1004C: 2 in Retractor Hook, 13-1008: 1 x 2½ in Retractor Blade	4½ in	114 mm



24-4590

Markham-Meyerding Hemilaminectomy Retractor

CODE	DESCRIPTION	DIMENSIONS	
24-4591	Blades On Left Arm	25 x 30mm	7¼ in 184mm
24-4590	Blades On Right Arm	25 x 30mm	7¼ in 184mm
50-1205	Self-Retaining, Left	25 x 51mm	7 in 178 mm
50-1206	Self-Retaining, Right	25 x 51mm	7 in 178 mm

Spine (Lamina)

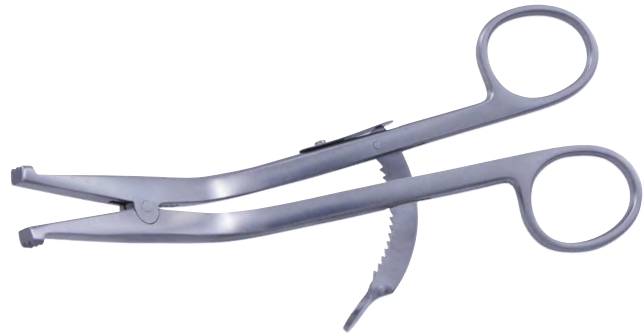

Cloward Lamina Retractor

CODE	DESCRIPTION
57-5575	With Ratchet

Spine (Laminectomy)



Badgley Laminectomy Retractor

Self-Retaining

CODE	TOTAL OPENING	BLADE
50-1255	6 ³ / ₈ in 162 mm	1 ³ / ₄ x 2 in 44 x 51



50-1160

Beckman-Adson Laminectomy Retractor

Self-Retaining with Hinged Arms

CODE	DESCRIPTION	BLADE	TOTAL OPENING	LENGTH
50-1161	Sharp	1 in 25 mm	5 in 127 mm	12 in 305 mm
50-1160	Blunt	1 x 1 ¹ / ₄ in 25 x 32 mm	5 in 127 mm	12 in 305 mm
50-1162	Blunt	1 x 1 in 25 x 25 mm	5 ¹ / ₂ in 140 mm	12 in 305 mm

Spine (Laminectomy)



50-1167

Cone Laminectomy Retractor

Self-Retaining, Hinged Arms

CODE	DESCRIPTION	LENGTH
50-1167	3 x 4 Prongs, Sharp	6 ³ / ₈ in 162 mm
50-1168	3 x 4 Prongs, Sharp	8 in 203 mm



50-1190

Meyering Laminectomy Retractor

Self-Retaining

CODE	BLADE	TOTAL OPENING	LENGTH
50-1190	1 in x 2 ¹ / ₄ in 25 x 57 mm	3 ³ / ₄ in 95 mm	6 ¹ / ₂ in 165 mm
50-1191	1 in x 2 in 25 x 51 mm	3 ³ / ₄ in 95 mm	6 ¹ / ₂ in 165 mm
50-1192	1 in x 1 ³ / ₄ in 25 x 41 mm	3 ³ / ₄ in 95 mm	6 ¹ / ₂ in 165 mm



50-1065

Meyering Laminectomy Retractor

CODE	DESCRIPTION	BLADE	LENGTH
50-1065	Small, Hand Held	⁵ / ₈ x 2 in 16 x 51 mm	9 in 229 mm
50-1066	Medium, Hand Held	1 x 3 in 25 x 76 mm	9 ¹ / ₂ in 241 mm
50-1067	Large, Hand Held	2 x 3 ¹ / ₂ in 51 x 89 mm	9 ¹ / ₂ in 241 mm

Spine (Laminectomy)



Poppen-Gelpi Laminectomy Retractor

CODE	DESCRIPTION	TOTAL OPENING	LENGTH
50-1212	Self-Retaining	2½ in 64 mm	5½ in 140 mm



Seletz-Gelpi Laminectomy Retractor

With Arms Bent at Right Angles

CODE	DESCRIPTION	ARM LENGTH	TOTAL OPENING	LENGTH
50-1211	Self-Retaining	2¾ in 65 mm	3¾ in 95 mm	6¼ in 159 mm

Spine (Lumbar)



Caspar Lumbar Speculum

57-5646

CODE	DESCRIPTION
57-5646	40 mm
57-5647	45 mm
57-5648	50 mm
57-5649	55 mm
57-5650	60 mm

Spine (Karlin™)

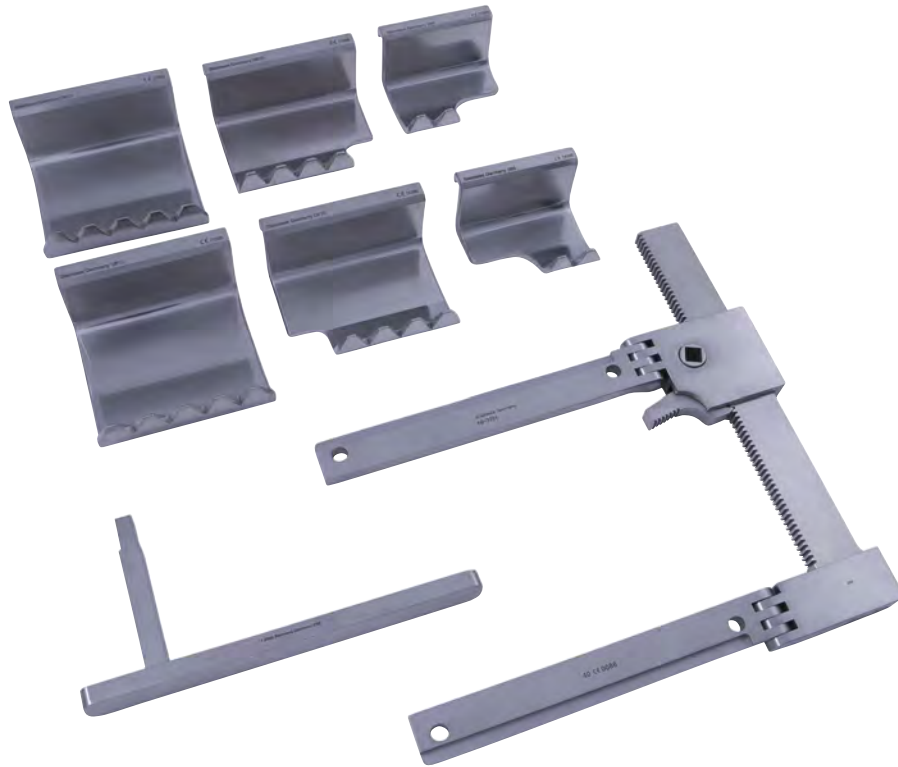

Karlin™ Crank Frame Spinal Retractor Set

CODE	DESCRIPTION	LENGTH
46-3190	Designed for posterior Lumbar and Thoracic spine surgery. Arm design allows the blades to be pre-positioned in the wound prior to attachment. Blades are interchangeable. Multiple blades may be used on each retractor arm. Maximum width opening 5½ in (140 mm) Crank Frame Spinal Retractor Set Includes:	2¼ x 2½ in 57 x 64 mm
46-3191	Crank Frame Retractor Body	
46-3192	Crank Frame Retractor Ratchet	
46-3193	Blade with Sacral Cutout, Left	1¼ x 1½ in 31 x 38 mm
46-3194	Blade with Sacral Cutout, Right	1¼ x 1½ in 31 x 38 mm
46-3195	Blade with Sacral Cutout, Left	2¼ x 1¾ in 57 x 44 mm
46-3196	Blade with Sacral Cutout, Right	3 x 2½ in 57 x 44 mm
46-3197	Blade, Left/Right (2 Blades in Set, 1 with re-order)	1¼ x 1½ in 76 x 64 mm

Spine (Karlin™)



46-3202

Karlin™ Crank Frame Retractor Blade

Left and Right Pair, Offset

CODE	DESCRIPTION	DIMENSIONS
46-3199		$\frac{3}{4}$ x 1 $\frac{1}{4}$ in
46-3200		$\frac{3}{4}$ x 1 $\frac{3}{4}$ in
46-3201		$\frac{3}{4}$ x 2 $\frac{1}{4}$ in
46-3202		$\frac{3}{4}$ x 3 in
46-3203		$\frac{3}{4}$ x 3 $\frac{1}{4}$ in
46-3204		$\frac{3}{4}$ x 4 in
46-3205	Not Offset	2 x 4 in

Spine (Micro Discectomy)



57-2952

Micro Discectomy Retractor

Self-Retaining

CODE	DESCRIPTION	LENGTH	TOTAL LENGTH
57-2951	Left Hook	50 x 10 mm	6 in 152 mm
57-2952	Left Hook	50 x 20 mm	6 in 152 mm
57-2961	Left Hook	60 x 10 mm	6 in 152 mm
57-2962	Left Hook	60 x 20 mm	6 in 152 mm
57-2971	Left Hook	70 x 10 mm	6 in 152 mm
57-2972	Left Hook	70 x 20 mm	6 in 152 mm
57-2851	Right Hook	50 x 10 mm	6 in 152 mm
57-2852	Right Hook	50 x 20 mm	6 in 152 mm
57-2861	Right Hook	60 x 10 mm	6 in 152 mm
57-2862	Right Hook	60 x 20 mm	6 in 152 mm
57-2871	Right Hook	70 x 10 mm	6 in 152 mm
57-2872	Right Hook	70 x 20 mm	6 in 152 mm

Spine (McCulloch)



57-5721

McCulloch Hinged Retractor

Black Finish Blades are for use with Black Finish Frames

CODE	DESCRIPTION
57-5721	Frame Only, Black Finish
57-5721T	Frame Only, Titanium



57-5720

McCulloch Rigid Retractor

Frame Only

CODE	DESCRIPTION	LENGTH
57-5720	Black blades Must be used with the Black Frame	50 mm
57-5720T	Titanium	60 mm

Spine (McCulloch)



57-5739

McCulloch Hook Blade

Sold Individually

CODE	BLADE WIDTH	HOOK DEPTH	
57-5738	Black Finish	$\frac{3}{4}$ in	20 mm
57-5739	Black Finish	$1\frac{1}{8}$ in	30 mm
57-5740 mm	Black Finish	$1\frac{1}{2}$ in	40 mm
57-5741	Black Finish	$1\frac{7}{8}$ in	50 mm
57-5742	Black Finish	$2\frac{3}{8}$ in	60 mm
57-5743	Black Finish	$2\frac{3}{4}$ in	70 mm
57-5751	Black Finish	$3\frac{1}{8}$ in	80 mm



57-5750T

McCulloch Hook Blade

CODE	DESCRIPTION	HOOK DEPTH	
57-5739T	Titanium	$1\frac{1}{8}$ in	30 mm
57-5740T	Titanium	$1\frac{1}{2}$ in	40 mm
57-5741T	Titanium	$1\frac{7}{8}$ in	50 mm
57-5742T	Titanium	$2\frac{3}{8}$ in	60 mm
57-5743T	Titanium	$2\frac{3}{4}$ in	70 mm
57-5750T	Titanium	$3\frac{1}{8}$ in	80 mm

Spine (McCulloch)



57-5746

McCulloch Multi-Hooked Blade

Sold Individually

CODE	DESCRIPTION	HOOK DEPTH	
57-5744	Black Finish	$\frac{3}{4}$ in	20 mm
57-5745	Black Finish	$1\frac{1}{8}$ in	30 mm
57-5746	Black Finish	$1\frac{1}{2}$ in	40 mm
57-5747	Black Finish	$1\frac{7}{8}$ in	50 mm
57-5748	Black Finish	$2\frac{3}{8}$ in	60 mm
57-5749	Black Finish	$2\frac{3}{4}$ in	70 mm
57-5753	Black Finish	$3\frac{1}{8}$ in	80 mm
57-5752	Black Finish	$3\frac{1}{2}$ in	90 mm



57-5745T

McCulloch Multi-Hooked Blade

CODE	DESCRIPTION	HOOK DEPTH	
57-5744T	Titanium	$\frac{3}{4}$ in	20 mm
57-5745T	Titanium	$1\frac{1}{8}$ in	30 mm
57-5746T	Titanium	$1\frac{1}{2}$ in	40 mm
57-5747T	Titanium	$1\frac{7}{8}$ in	50 mm
57-5748T	Titanium	$2\frac{3}{8}$ in	60 mm
57-5749T	Titanium	$2\frac{3}{4}$ in	70 mm



57-5793

McCulloch Thin Muscle Blade

Black Finish, Sold individually

CODE	BLADE W X D
57-5793	$\frac{1}{16}$ x $1\frac{1}{2}$ in 17 x 40 mm
57-5794	$\frac{1}{16}$ x $1\frac{7}{8}$ in 17 x 50 mm
57-5795	$\frac{1}{16}$ x $1\frac{3}{8}$ in 17 x 60 mm
57-5796	$\frac{1}{16}$ x $2\frac{3}{4}$ in 17 x 70 mm

Spine (McCulloch)



McCulloch Narrow Muscle Retractor Blade

57-5732

1 Pair

CODE	DESCRIPTION	HOOK DEPTH	
57-5732	Black Finish	$\frac{3}{4}$ in	30 mm
57-5733	Black Finish	$1\frac{1}{8}$ in	40 mm
57-5734	Black Finish	$1\frac{1}{2}$ in	50 mm
57-5735	Black Finish	$1\frac{7}{8}$ in	60 mm
57-5736	Black Finish	$2\frac{3}{8}$ in	70 mm
57-5737	Black Finish	$2\frac{3}{4}$ in	80 mm
57-5772	Black Finish	$3\frac{1}{8}$ in	90 mm
57-5773	Black Finish	$3\frac{1}{2}$ in	100 mm
57-5774	Black Finish	$4\frac{1}{4}$ in	110 mm
57-5775	Black Finish	$4\frac{5}{8}$ in	120 mm



McCulloch Narrow Muscle Retractor Blade

57-5781T

1 Pair

CODE	DESCRIPTION	HOOK DEPTH	
57-5732T	Titanium	$\frac{3}{4}$ in	30 mm
57-5733T	Titanium	$1\frac{1}{8}$ in	40 mm
57-5734T	Titanium	$1\frac{1}{2}$ in	50 mm
57-5735T	Titanium	$1\frac{7}{8}$ in	60 mm
57-5736T	Titanium	$2\frac{3}{8}$ in	70 mm
57-5737T	Titanium	$2\frac{3}{4}$ in	80 mm
57-5781T	Titanium	$3\frac{1}{8}$ in	90 mm

Spine (McCulloch)



57-5790

McCulloch Single Cervical Blade

CODE	DESCRIPTION
57-5790-40	2 Teeth, 40 mm
57-5790	2 Teeth, 50 mm
57-5791	2 Teeth, 60 mm
57-5792	2 Teeth, 70 mm



57-5726

McCulloch Wide Muscle Retractor Blade

2.7 mm Wide

CODE	DESCRIPTION	BLADE DEPTH	
57-5726	Black Finish	$\frac{3}{4}$ in	30 mm
57-5727	Black Finish	$1\frac{1}{8}$ in	40 mm
57-5728	Black Finish	$1\frac{1}{2}$ in	50 mm
57-5729	Black Finish	$1\frac{7}{8}$ in	60 mm
57-5730	Black Finish	$2\frac{3}{8}$ in	70 mm
57-5731	Black Finish	$2\frac{3}{4}$ in	80 mm
57-5783	Black Finish	$3\frac{1}{8}$ in	90mm
57-5784	Black Finish	$3\frac{1}{2}$ in	100 mm
57-5785	Black Finish	$4\frac{1}{4}$ in	110 mm
57-5786	Black Finish	$4\frac{5}{8}$ in	120 mm

Spine (McCulloch)



57-5730T

McCulloch Wide Muscle Retractor Blade

1 Pair

CODE	DESCRIPTION	BLADE DEPTH	
57-5726T	Titanium	$\frac{3}{4}$ in	30 mm
57-5727T	Titanium	$1\frac{1}{8}$ in	40 mm
57-5728T	Titanium	$1\frac{1}{2}$ in	50 mm
57-5729T	Titanium	$1\frac{7}{8}$ in	60 mm
57-5730T	Titanium	$2\frac{3}{8}$ in	70 mm
57-5731T	Titanium	$2\frac{3}{4}$ in	80 mm
57-5783T	Titanium	$3\frac{1}{8}$ in	90 mm

Spine (Nerve Root)



57-5762

McCulloch Nerve Root Retractor

CODE	LENGTH
57-5761	$\frac{3}{4}$ in 30 mm
57-5762	$1\frac{1}{8}$ in 40 mm

Spine (Nerve Root)

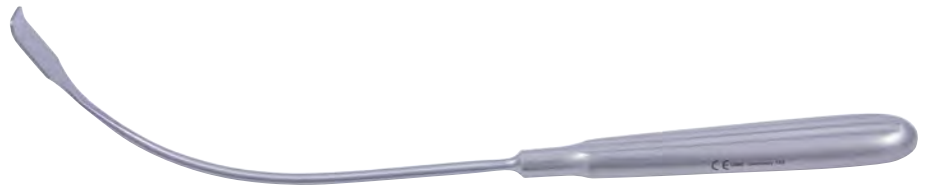

Campbell Nerve Root Retractor

CODE	DESCRIPTION	BLADE WIDTH		LENGTH	
50-1326	Malleable Shaft	$\frac{3}{8}$ in	10 mm	8 $\frac{1}{2}$ in	216 mm



57-9006

Caspar Nerve Root Retractor

CODE	DESCRIPTION	BLADE WIDTH		LENGTH	
57-9006		6 mm	6 mm	9 $\frac{1}{2}$ in	241 mm
57-9008		8 mm	8 mm	9 $\frac{1}{2}$ in	241 mm
57-9010		10 mm	10 mm	9 $\frac{1}{2}$ in	241 mm



D'Errico Nerve Root Retractor

CODE	DESCRIPTION	BLADE WIDTH		LENGTH	
20-1814	Bayonet	$\frac{1}{4}$ in	6 mm	9 in	229 mm



Flexible Nerve Root Retractor

CODE	DESCRIPTION	BLADE LENGTH		BLADE WIDTH		LENGTH	
50-1209	Nerve Root Retractor	1 in	25 mm	$\frac{5}{16}$ in	8 mm	8 $\frac{1}{2}$ in	216 mm

Spine (Nerve Root)



Holsher Nerve Root Retractor

CODE	DESCRIPTION	BLADE WIDTH	LENGTH
50-1331	Nerve Root Retractor	$\frac{5}{16}$ in 7 mm	9 $\frac{3}{4}$ in 248 mm



50-1315

Love Nerve Root Retractor

CODE	DESCRIPTION	BLADE WIDTH	SHAFT LENGTH	LENGTH
50-1315	Straight	$\frac{1}{4}$ in 6 mm	4 in 102 mm	7 $\frac{5}{8}$ in 194 mm
50-1316	90° Angle	$\frac{1}{4}$ in 6 mm	4 in 102 mm	3 $\frac{3}{4}$ in 95 mm
50-1317	135° Angle	$\frac{1}{4}$ in 6 mm	4 in 102 mm	3 $\frac{1}{4}$ in 83 mm



50-1291

Scoville Nerve Root Retractor

90° Angle

CODE	BLADE WIDTH	SHAFT LENGTH	HANDLE LENGTH
50-1291	$\frac{5}{16}$ in 8 mm	4 $\frac{1}{4}$ in 108 mm	5 in 127 mm
50-1293	$\frac{1}{2}$ in 13 mm	4 $\frac{1}{4}$ in 108 mm	5 in 127 mm

Spine (Nerve Root)



Smith Nerve Root Suction Retractor

CODE	DESCRIPTION	SHAFT LENGTH	TIP WIDTH	TIP DEPTH
50-1275	With Obturator and Thumb Control for Suction	5¼ in 133 mm	¼ in 6mm	⅛ in 3mm



Weary Nerve Root Retractor

CODE	BLADE WIDTH	SHAFT LENGTH	HANDLE LENGTH
50-1310	⅞ in 11 mm	5¾ in 146 mm	5¾ in 146 mm

Spine (Self-Retaining)



50-1050

Blade Retractor

CODE	WIDTH	LENGTH	HANDLE LENGTH	CODE	WIDTH	LENGTH	HANDLE LENGTH
50-1050	18 mm	3 in 76 mm	4½ in 114 mm	50-1053	23 mm	3 in 76 mm	4½ in 114 mm
50-1052	20 mm	3 in 76 mm	4½ in 114 mm				

Spine (Bookwalter®)



Bookwalter® Spinal Retractor Kit, 12 inch Post (305mm)

CODE	DESCRIPTION	LENGTH	
50-4631	Bookwalter® Spinal Retractor Kit		
50-4581	Table Post	12 in	304 mm
50-4582	Horizontal Flex Bar		
50-4635	Small, 1 Pair	8 ½ in	216 mm
50-4636	Straight Ring Segment (Pair)	4 in	102 mm
50-4637	Straight Ring Segment (Pair)	6 in	152 mm
50-4638	Straight Ring Segment (Pair)	8 in	203 mm
50-4580	Case Holds Six-Each Tilting Ratchet Mechanisms		
50-4639	Bookwalter® Scoville Hook, Small	2 in	50 mm
50-4640	Bookwalter® Scoville Hook, Large	3 ¼ in	83 mm
50-4641	Bookwalter®-Meyerding Retractor Blade, Small	⅔ x 2 ⅓ in	17 x 60 mm
50-4642	Bookwalter®-Meyerding Retractor Blade, Medium	1 x 3 ½ in	25 x 85 mm
50-4643	Bookwalter®-Meyerding Retractor Blade, Large	2 x 3 ¾ in	50 x 95 mm
50-4645	Bookwalter® Rake Retractor-Medium, Rake Retractor, 4 Prong	⅓ x ¾ in	8 ⅔ x 19 mm
50-4646	Bookwalter® Rake Retractor-Large, Rake Retractor, 6 Prong	⅓ x 1 in	8 ⅔ x 25 mm
50-4644	Bookwalter® Rake Retractor-Deep, Rake Retractor, 3 Prong	¾ x ⅔ in	19 x 17 mm
50-4647	Bookwalter® Spinal Retractor, Storage/Sterilizing Case; Depth 4 in (100 mm)	19 ½ x 13 ½ in	500 x 340 mm

Spine (Bookwalter®)

Bookwalter® Anterior Lumbar Retractor System

CODE	DESCRIPTION	QTY
50-5740	Bookwalter® Anterior Lumbar Spinal Kit Includes the Following:	
50-4688	Bookwalter® Lightweight Table Post, 12 in	1
50-4554	Bookwalter® Table Post Coupling	1
50-4582	Bookwalter® Lightweight Horizontal Flex Bar	1
50-4583	Bookwalter® Segmented Ring, Medium	1
50-4588	Bookwalter® Segmented Ring, Large	1
50-4696	Bookwalter® Self-Retaining Rotilt Ratchet	6
50-5580	Bookwalter® 1x4 Radiolucent Titanium Retractor Blade	2
50-5581	Bookwalter® 1x5 Radiolucent Titanium Retractor Blade	2
50-5587	Bookwalter® 2x6 Radiolucent Titanium Retractor Blade	2
50-5588	Bookwalter® 2x7 Radiolucent Titanium Retractor Blade	2
50-5589	Bookwalter® 2x8 Radiolucent Titanium Retractor Blade	2
67-7504	Bookwalter® 2x11 Opti-Length® Malleable Retractor Blade with Malleable Lip	1

Kits (Anterior Cervical Fusion)



59-0600



59-0000

Ultra™ ReVeal ACF Distraction System

Tray One of Three

CODE	DESCRIPTION	COLOR	LENGTH	QTY
59-0000	Complete System: Tray One of Three			1
59-0030	ACF Blade, Blunt	Silver	1 1/8 in 30 mm	2
59-0031	ACF Blade, Blunt	Blue	1 3/8 in 35 mm	2
59-0032	ACF Blade, Blunt	Red	1 5/8 in 40 mm	2
59-0033	ACF Blade, Blunt	Green	1 3/4 in 45 mm	2
59-0034	ACF Blade, Blunt	Violet	2 in 50 mm	2
59-0035	ACF Blade, Blunt	Black	2 1/8 in 55 mm	2
59-0036	ACF Blade, Blunt	Gold	2 3/8 in 60 mm	2
59-0037	ACF Blade, Blunt	Navy	2 1/2 in 65 mm	2
59-0038	ACF Blade, Blunt	Light Green	2 3/4 in 70 mm	2
59-0039	ACF Blade, Blunt	Orange	3 in 75 mm	2
59-0080	ACF Micro Blade, Blunt	Blue	9/16 x 1 3/8 in 14 x 35 mm	2
59-0081	ACF Micro Blade, Blunt	Red	9/16 x 1 5/8 in 14 x 40 mm	2
59-0082	ACF Micro Blade, Blunt	Green	9/16 x 1 3/4 in 14 x 45 mm	2
59-0083	ACF Micro Blade, Blunt	Violet	9/16 x 2 1/8 in 14 x 50 mm	2
59-0084	ACF Micro Blade, Blunt	Black	9/16 x 2 1/8 in 14 x 55 mm	2
59-0085	ACF Micro Blade, Blunt	Gold	9/16 x 2 1/8 in 14 x 50 mm	2
59-0090	ACF Micro Blade, Short Teeth	Blue	9/16 x 1 3/8 in 14 x 35 mm	2
59-0091	ACF Micro Blade, Short Teeth	Red	9/16 x 1 5/8 in 14 x 40 mm	2
59-0092	ACF Micro Blade, Short Teeth	Green	9/16 x 1 3/4 in 14 x 45 mm	2
59-0093	ACF Micro Blade, Short Teeth	Violet	9/16 x 2 1/8 in 14 x 50 mm	2
59-0094	ACF Micro Blade, Short Teeth	Black	9/16 x 2 1/8 in 14 x 55 mm	2
59-0095	ACF Micro Blade, Short Teeth	Gold	9/16 x 2 3/8 in 14 x 60 mm	2
59-0106	ACF Color Coded Depth Gauge			1
59-0105	Blade Loading Locking Retractor Handle			2

Kits (Anterior Cervical Fusion)



Ultra™ ReVeal ACF Removal Body Tray

Tray Two of Three

CODE	DESCRIPTION	COLOR	LENGTH	QTY
59-0000	Complete System, Continued: Tray Two of Three			1
59-0050	ACF Blade, Short Teeth	Silver	1 1/8 in 30 mm	1
59-0051	ACF Blade, Short Teeth	Blue	1 3/8 in 35 mm	1
59-0052	ACF Blade, Short Teeth	Red	1 5/8 in 40 mm	1
59-0053	ACF Blade, Short Teeth	Green	1 3/4 in 45 mm	1
59-0054	ACF Blade, Short Teeth	Violet	2 in 50 mm	1
59-0055	ACF Blade, Short Teeth	Black	2 1/8 in 55 mm	1
59-0056	ACF Blade, Short Teeth	Gold	2 3/8 in 60 mm	1
59-0057	ACF Blade, Short Teeth	Navy	2 1/2 in 65 mm	1
59-0070	ACF Blade, Long Teeth	Silver	1 1/8 in 30 mm	1
59-0071	ACF Blade, Long Teeth	Blue	1 3/8 in 35 mm	1
59-0072	ACF Blade, Long Teeth	Red	1 5/8 in 40 mm	1
59-0073	ACF Blade, Long Teeth	Green	1 3/4 in 45 mm	1
59-0074	ACF Blade, Long Teeth	Violet	2 in 50 mm	1
59-0075	ACF Blade, Long Teeth	Black	2 1/8 in 55 mm	1
59-0076	ACF Blade, Long Teeth	Gold	2 3/8 in 60 mm	1
59-0077	ACF Blade, Long Teeth	Navy	2 1/2 in 65 mm	1
59-0101	Side-Loading Longitudinal Retractor, with Double Hinge			1
59-0100	Side-Loading Transverse Retractor, with Double Hinge		4 3/4 in 120 mm	1
59-0113	Screw Driver			2
59-0109	Twist Drill			2

Kits (Anterior Cervical Fusion)



Ultra™ ReVeal ACF Cervical Retractor Tray

Tray Three of Three

CODE	DESCRIPTION	QTY
59-0000	Complete System, Continued: Tray Three of Three	1
59-0131	Bone Graft Holder	1
59-0117	Distractor Single Level, Left with 3 ¹⁵ / ₁₆ in (100 mm) Rack	1
59-0118	Distractor Single Level, Right with 3 ¹⁵ / ₁₆ in (100 mm) Rack	1
59-0116	Distractor Multiple Level, Left with 4 ³ / ₄ in (120 mm) Rack	1
59-0115	Distractor Multiple Level, Right with 4 ³ / ₄ in (120 mm) Rack	1
59-0111	Drill Guide, Left for 59-0116/59-0117	1
59-0110	Drill Guide, Right for 59-0118/59-0115	1
59-0120	ACF Caliper	1
59-0124	ACF Bone Graft Harvesting Forcep, ³ / ₁₁ in (7 mm)	1
59-0121	ACF Bone Tamp, ¹ / ₈ in (3 mm)	1
59-0122	ACF Bone Tamp, ¹ / ₈ in (5 mm)	1
59-0123	ACF Bone Tamp, ⁵ / ₁₆ in (8 mm)	1

Kits (Cervical Retractor)



Ultra™ ReVeal LoPro Retractor Tray

59-3000

CODE	DESCRIPTION	LENGTH	QUANTITY
59-3000	System Includes the Following:		
59-2001	Cervical Retractor Frame, Right		1
59-2002	Cervical Retractor Frame, Left		1
59-2003	Cervical Retractor Frame, Offset		1
59-2006	Cervical Retractor Blade, Pronged	$\frac{7}{8}$ x 1 in 22 x 25 mm	2
59-2007	Cervical Retractor Blade, Pronged	$\frac{7}{8}$ x $1\frac{1}{8}$ in 22 x 30 mm	2
59-2008	Cervical Retractor Blade, Pronged	$\frac{7}{8}$ x $1\frac{3}{8}$ in 22 x 35 mm	2
59-2009	Cervical Retractor Blade, Pronged	$\frac{7}{8}$ x $1\frac{5}{8}$ in 22 x 40 mm	2
59-2010	Cervical Retractor Blade, Pronged	$\frac{7}{8}$ x $1\frac{3}{4}$ in 22 x 45 mm	2
59-2011	Cervical Retractor Blade, Pronged	$\frac{7}{8}$ x $2\frac{1}{8}$ in 22 x 50 mm	2
59-2012	Cervical Retractor Blade, Pronged	$\frac{7}{8}$ x $2\frac{1}{8}$ in 22 x 55 mm	2
59-2013	Cervical Retractor Blade, Pronged	$\frac{7}{8}$ x $2\frac{3}{8}$ in 22 x 60 mm	2
59-2014	Cervical Retractor Blade, Pronged	$\frac{7}{8}$ x $2\frac{1}{2}$ in 22 x 65 mm	2
59-2015	Cervical Retractor Blade, Pronged	$\frac{7}{8}$ x $2\frac{3}{4}$ in 22 x 70 mm	2
59-2016	Cervical Retractor Blade, Pronged	$\frac{7}{8}$ x 3 in 22 x 75 mm	2
59-2017	Cervical Retractor Blade, Blunt	$\frac{7}{8}$ x 1 in 22 x 25 mm	2
59-2018	Cervical Retractor Blade, Blunt	$\frac{7}{8}$ x $1\frac{1}{8}$ in 22 x 30 mm	2
59-2019	Cervical Retractor Blade, Blunt	$\frac{7}{8}$ x $1\frac{3}{8}$ in 22 x 35 mm	2
59-2020	Cervical Retractor Blade, Blunt	$\frac{7}{8}$ x $1\frac{5}{8}$ in 22 x 40 mm	2
59-2021	Cervical Retractor Blade, Blunt	$\frac{7}{8}$ x $1\frac{3}{4}$ in 22 x 45 mm	2
59-2023	Cervical Retractor Blade, Blunt	$\frac{7}{8}$ x $2\frac{1}{8}$ in 22 x 50 mm	2
59-2024	Cervical Retractor Blade, Blunt	$\frac{7}{8}$ x $2\frac{1}{8}$ in 22 x 55 mm	2
59-2025	Cervical Retractor Blade, Blunt	$\frac{7}{8}$ x $2\frac{3}{8}$ in 22 x 60 mm	2
59-2026	Cervical Retractor Blade, Bi-Leveled Pronged	$1\frac{1}{16}$ x $1\frac{1}{8}$ in 27 x 30 mm	4
59-2028	Cervical Retractor Blade, Bi-Leveled Pronged	$1\frac{1}{16}$ x $1\frac{5}{8}$ in 27 x 40 mm	4
59-2035	Cervical Retractor Blade, Bi-Leveled Pronged	$1\frac{1}{16}$ x $1\frac{3}{4}$ in 27 x 45 mm	4
59-2027	Cervical Retractor Blade, Bi-Leveled Blunt	$1\frac{1}{16}$ x $1\frac{1}{8}$ in 27 x 30 mm	2
59-2029	Cervical Retractor Blade, Bi-Leveled Blunt	$1\frac{1}{16}$ x $1\frac{5}{8}$ in 27 x 40 mm	2
59-2036	Cervical Retractor Blade, Bi-Leveled Blunt	$1\frac{1}{16}$ x $1\frac{3}{4}$ in 27 x 45 mm	2
59-2037	Micro Discectomy Adaptor for ACF Retractor Set		1
59-2038	Spike Blade	$2\frac{3}{4}$ in 70 mm	1
59-2039	T-Shaped Blade	$2\frac{3}{4}$ in 70 mm	1
59-2004	Inner Spine Ligament		1
59-2005	Blade Holding Retractor		2
59-2040	Case		1

Kits (Cervical Retractor)



Ultra™ ReVeal Lumbar Instrument

Tray One of Three

59-1000S

CODE	DESCRIPTION	DIMENSIONS		QUANTITY
59-1000S	Ultra™ ReVeal Lumbar System Includes the Following:			1
59-1104	Scoville Lumbar Retractor, Double Hinged	7 $\frac{7}{8}$ in	200 mm	1
59-1100	Lumbar Retractor Body for Multiple Blades			1
59-1103	Side-Loading Lumbar Retractor Blade Holder			4
59-1102	Lumbar Retractor Adjustable Blade Holder			4
59-1001	Lumbar Retractor T-Handle			1
59-1105	Side-Loading Locking Retractor Handle			2
59-1080	Hook, Sharp Toothed Shaft	1 $\frac{5}{8}$ in	40 mm	1
59-1081	Hook, Sharp Toothed Shaft	2 in	50 mm	1
59-1082	Hook, Sharp Toothed Shaft	2 $\frac{3}{8}$ in	60 mm	1
59-1083	Hook, Sharp Toothed Shaft	2 $\frac{3}{4}$ in	70 mm	1
59-1084	Lumbar Spine T-Bar	1 x 1 $\frac{5}{8}$ in	25 x 40 mm	1
59-1085	Lumbar Spine T-Bar	1 x 2 in	25 x 50 mm	1
59-1086	Lumbar Spine T-Bar	1 x 2 $\frac{3}{8}$ in	25 x 60 mm	1
59-1087	Lumbar Spine T-Bar	1 x 2 $\frac{3}{4}$ in	25 x 70 mm	1

Ultra™ ReVeal Lumbar Instrument System

Tray Two of Three

CODE	DESCRIPTION	DIMENSIONS		QUANTITY
59-1030	Blade Angled Out 15°	$\frac{10}{11}$ x 1 $\frac{3}{8}$ in	23 x 35 mm	4
59-1031	Blade Angled Out 15°	$\frac{10}{11}$ x 1 $\frac{3}{4}$ in	23 x 45 mm	4
59-1032	Blade Angled Out 15°	$\frac{10}{11}$ x 2 $\frac{1}{8}$ in	23 x 55 mm	4
59-1033	Blade Angled Out 15°	$\frac{10}{11}$ x 2 $\frac{1}{2}$ in	23 x 65 mm	4
59-1034	Blade Angled Out 15°	$\frac{10}{11}$ x 3 in	23 x 75 mm	4
59-1035	Blade Angled Out 15°	$\frac{10}{11}$ x 3 $\frac{3}{8}$ in	23 x 85 mm	4
59-1036	Blade Angled Out 15°	$\frac{10}{11}$ x 3 $\frac{15}{16}$ in	23 x 100 mm	4
59-1037	Blade Angled Out 15°	$\frac{10}{11}$ x 4 $\frac{3}{4}$ in	23 x 120 mm	4

Kits (Cervical Retractor)

Ultra™ ReVeal Lumbar Instrument System

Tray Three of Three

CODE	DESCRIPTION	DIMENSIONS		QUANTITY
59-1050	Blade Angled Out 15°	1¾ x 2 in	45 x 50 mm	2
59-1051	Blade Angled Out 15°	1¾ x 2⅜ in	45 x 60 mm	2
59-1052	Blade Angled Out 15°	1¾ x 2¾ in	45 x 70 mm	2
59-1053	Blade Angled Out 15°	1¾ x 3⅛ in	45 x 80 mm	2
59-1056	Blade Angled Out 15°	2⅜ x 2 in	60 x 50 mm	2
59-1057	Blade Angled Out 15°	2⅜ x 2⅜ in	60 x 60 mm	2
59-1058	Blade Angled Out 15°	2⅜ x 2¾ in	60 x 70 mm	2
59-1059	Blade Angled Out 15°	2⅜ x 3½ in	60 x 80 mm	2
59-1060	Blade Angled Out 15°	2⅜ x 3 ¹⁵ / ₁₆ in	60 x 100 mm	2
59-1061	Blade Angled Out 15°	2⅜ x 4¾ in	60 x 120 mm	2
59-1070	Blade Sacral Cutout, Right	1¼ x 1 ⁵ / ₈ in	30 x 40 mm	1
59-1071	Blade Sacral Cutout, Left	1¼ x 1 ⁵ / ₈ in	30 x 40 mm	1
59-1072	Blade Sacral Cutout, Right	2⅜ x 1¾ in	60 x 45 mm	1
59-1073	Blade Sacral Cutout, Left	2⅜ x 1¾ in	60 x 45 mm	1
59-1700	Case			1

Splanchnic



23-7040

Harrington Splanchnic Retractor

CODE	BLADE	LENGTH	
23-7040	42 x 127 mm	12½ in	316 mm
23-7062	62 x 127 mm	12½ in	316 mm



23-7106

Harrington-Pemberton Retractor

CODE	DESCRIPTION	SIZE		LENGTH	
23-7040	Retractor	1 ⁵ / ₈ x 5 in	41 x 127 mm	12½ in	318 mm
23-7106	Retractor	2½ x 7⅛ in	64 x 181 mm	12½ in	318 mm

Sternal

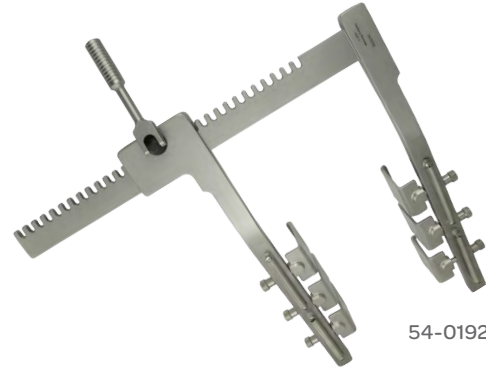

54-0192

Ankeney Sternal Retractor

CODE	DESCRIPTION
54-0192	Self-Retaining with Rack and Pinion Action. Complete with Six Detachable Swivel Blades and One Pair of Springs on Each Arm
54-0194	Set of Six Blades



30-9025

Castaneda Instrument Kit

CODE	DESCRIPTION	DIMENSION	
30-9025	Kit Includes the Following:		
30-9000	Multi-Purpose Clamp, Angled 30°		
30-9001	Multi-Purpose Clamp, Angled 50°		
30-9002	Partial Occlusion Clamp, Spoon Shape		
30-9003	Anastomosis Clamp, Small		
30-9004	Anastomosis Clamp, Medium		
30-9005	Anastomosis Clamp, Large, Castaneda Retractors	4 ⁵ / ₁₆ in	110 mm
50-8060	Sternal Retractor, Small		
50-8061	Sternal Retractor, Large		
30-8500	Vascular Forceps, Titanium, 2/Each	6 in	152 mm
19-8150	Mixer Clamp, Smooth Jaw	5 ¹ / ₄ in	133 mm
21-8010	Castaneda Instrument Case	11x7x2 in	279x178x51 mm

Sternal



Collins Radiopaque Sternal Blades

CODE	DESCRIPTION
50-8080	Arm length 8 ³ / ₄ (222 mm), Total Opening 8 ¹ / ₈ in (206 mm)



Cooley Sternal Retractor

54-1009

CODE	ARM LENGTH		BLADE LENGTH		BLADE DEPTH		SPREAD	
54-1009	3 ¹ / ₈ in	79 mm	³ / ₄ in	20 mm	¹ / ₂ in	14 mm	4 in	100 mm
54-1003	5 ³ / ₄ in	145 mm	2 in	50 mm	1 ³ / ₈ in	35 mm	8 ¹ / ₄ in	209 mm
54-1006	8 ¹ / ₂ in	215 mm	4 ³ / ₈ in	110 mm	1 ³ / ₈ in	35 mm	9 ³ / ₈ in	238 mm



Favaloro-Morse Sternal Retractor

With Two Pair of Fixed Sternal Blades

CODE	ARM LENGTH		BLADE LENGTH		BLADE DEPTH		SPREAD	
54-1860	6 in	150 mm	1 ¹ / ₂ in	40 mm	1 ¹ / ₂ in	40 mm	8 in	200 mm



Himmelstein Sternal Retractor

Self-Retaining with Ratchet Action and Flexible Arms

CODE	TOTAL OPENING		BLADE WIDTH		BLADE DEPTH		ARM LENGTH		LENGTH	
50-1133	5 in	127 mm	1 ¹ / ₈ in	35 mm	1 ¹ / ₄ in	32 mm	5 ¹ / ₄ in	133 mm	5 in	127 mm

Sternal



Morse Sternal Retractor

50-8066

Child and Adult Self-Retaining with Rack and Pinion Action

CODE	TOTAL OPENING	BLADE WIDTH	BLADE DEPTH	ARM LENGTH	LENGTH
50-8066	6 ¼ in 159 mm	¾ in 19 mm	¾ in 19 mm	6 in 152 mm	6 ¼ in 159 mm
50-8067	8 in 203 mm	1 ⅛ in 29 mm	1 in 25 mm	7 ½ in 191 mm	8 in 203 mm



Pacifico Sternal Retractor

Self-Retaining

CODE	TOTAL OPENING	UPPER & LOWER BLADE WIDTH	LOWER BLADE DEPTH	ARM LENGTH	LENGTH
50-8085	8 in 203 mm	¾ in 19 mm	1 ½ in 38 mm	6 in 152 mm	8 in 203 mm

Thoracotomy



Heitmiller Mini Thoracotomy Retractor

CODE	DESCRIPTION
54-2340	Mini Thoracotomy Retractor

Thymus



Thymus Retractor

CODE	DESCRIPTION	LENGTH
20-0707	Double-Ended	6 3/4 in 170 mm

Thymus (Hand-Held)



23-0306

Lahey Retractor

CODE	DESCRIPTION	BLADE (W X D)	LENGTH
23-0306	Retractor	6 x 3 mm	7 3/4 in 197 mm
50-4040C	Thyroid Retractor	1/4 x 1 in 6 x 25 mm	8 1/8 in 206 mm

Thyroid



Green Thyroid Retractor

CODE	DESCRIPTION	LENGTH
23-3512	Fenestrated Blade	8 1/2 in 215 mm

Thyroid

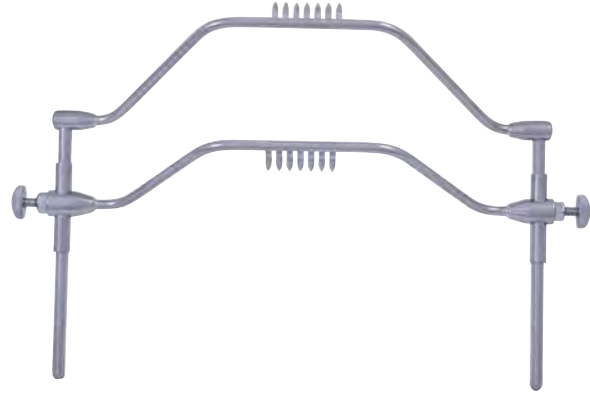

Mahorner Thyroid Retractor

CODE	DESCRIPTION	LENGTH
24-0888	7 Prong	10½ in 267 mm



20-1782

McBurney Thyroid Retractor

CODE	DESCRIPTION	LENGTH
20-1782	Fenestrated	7½ in 191 mm

Tonsil



Hurd Tonsil Dissector & Pillar Retractor

CODE	TIP SIZE	LENGTH
65-6600	½ in 13 mm	8¾ in 222 mm

Tracheal



Jackson Tracheal Retractor

CODE	DESCRIPTION	LENGTH
20-0708	Double-Ended	6 ³ / ₄ in 170 mm



News Tracheal Hook

CODE	DESCRIPTION	LENGTH
20-4015	Single Prong	6 in 150 mm

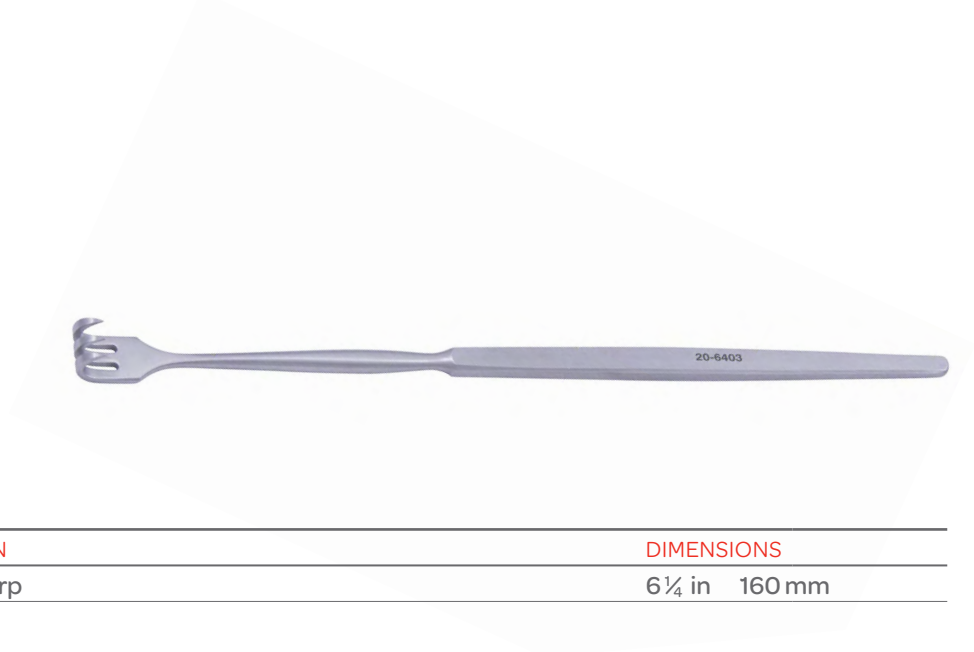

Tracheal Retractor

CODE	DESCRIPTION	DIMENSIONS
20-6403	3 Prong, Sharp	6 ¹ / ₄ in 160 mm

Uvula



Goodyear Uvula Retractor

CODE	WIDTH	LENGTH
71-6348	15 mm	7½ in 190 mm



Love Uvula Retractor

CODE	DESCRIPTION	LENGTH
71-6318	18 mm	6½ in 165 mm
71-6320	20 mm	6½ in 165 mm



71-6318

Love Uvula Retractor

CODE	WIDTH	LENGTH
71-6318	18 mm	6½ in 165 mm
71-6320	20 mm	6½ in 165 mm

Vaginal (Bookwalter®)



Bookwalter®-Magrina Deaver Blade

CODE	DESCRIPTION	DIMENSIONS	
50-4592	Small	1 x 3 ½ in	25 x 89 mm
50-4593	Large	1 x 5 in	25 x 127 mm



Bookwalter®-Magrina Lateral Blade

CODE	DESCRIPTION	LENGTH	
50-4591	45°	1 x 3 in	25 x 76 mm



Bookwalter®-Magrina Posterior Blade

CODE	DESCRIPTION	LENGTH	
50-4594	Posterior Blade	1 x 4 ½ in	25 x 114 mm

Vaginal (Bookwalter®)



Bookwalter®-Magrina Retractor System

CODE	NAME	QTY
50-4692	Vaginal Retractor Kit Includes Following Items:	
50-4688	Bookwalter® Lightweight Table Post, 12 in	1
50-4554	Bookwalter® Post Coupler	1
50-4582	Bookwalter® Lightweight Horizontal Flex Bar	1
50-4689	Bookwalter®-Magrina Segmented Ring with Suture Slots	1
50-4586	Bookwalter® Self-Retaining Tilting Ratchet	6
50-4694	Bookwalter® 1x4 Malleable Lateral Retractor Blade	2
50-4592	Bookwalter®-Magrina Deaver Blade, Small	1
50-4593	Bookwalter®-Magrina Deaver Blade, Large	1
50-4594	Bookwalter®-Magrina Posterior Retractor Blade	1

Vaginal (Bookwalter®)

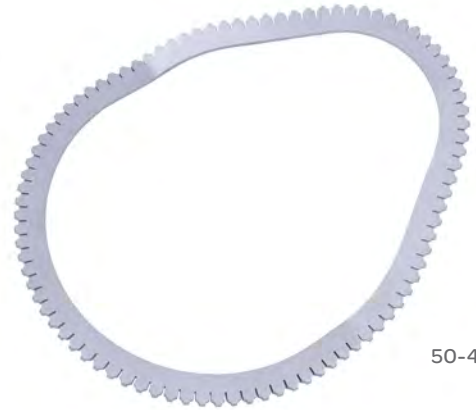

50-4690

Bookwalter®-Magrina Pelvic Rings

CODE	DESCRIPTION	LENGTH
50-4590	Fixed Basic Ovoid Ring	8 x 10 ½ in 203 x 267 mm
50-4690	Fixed Ovoid Ring with Suture Slots	8 x 10 ½ in 203 x 267 mm
50-4689	Segmented Ovoid Ring with Suture Slots	8 x 10 ½ in 203 x 267 mm



52-2601

Breisky Vaginal Retractor

Slight Curve

CODE	No.	LENGTH
52-2601	#1	¾ x 4 in 19 x 102 mm
52-2602	#2	1 x 4 in 25 x 102 mm
52-2603	#3	1¼ x 4 in 32 x 102 mm
52-2604	#4	1⅜ x 4 in 35 x 102 mm
52-2605	#5	1⅝ x 4 in 41 x 102 mm
52-2606	#6	1⅞ x 4 ¾ in 29 x 121 mm
52-2607	#7	1⅜ x 5⅞ in 35 x 130 mm
52-2609	#9	1⅜ x 6¼ in 35 x 159 mm
52-2610	#10	1 x 6 ⅞ in 25 x 170 mm

Vaginal



52-2332

Eastman Vaginal Retractor

CODE	No.	LENGTH
52-2331	#1	1 $\frac{3}{8}$ x 3 in 35 x 76 mm
52-2332	#2	1 $\frac{3}{8}$ x 3 $\frac{1}{2}$ in 35 x 89 mm
52-2333	#3	1 $\frac{5}{8}$ x 4 in 41 x 102 mm



50-5570

Heaney-Simon Vaginal Retractor

CODE	BLADE	LENGTH
50-5570	1 x 4 $\frac{1}{2}$ in 25 x 114 mm	10 $\frac{1}{4}$ in 260 mm
52-2727	1 x 4 $\frac{1}{2}$ in 25 x 114 mm	11 in 279 mm

Vaginal



50-5540

Jackson Vaginal Retractor

CODE	SIZE	BLADE	LENGTH
52-2301	#1	1 ³ / ₈ x 3 in 35 x 76 mm	7 ¹ / ₄ in 184 mm
52-2302	#2	1 ³ / ₈ x 3 ¹ / ₂ in 35 x 89 mm	7 ¹ / ₄ in 184 mm
52-2303	#3	1 ¹ / ₂ x 4 in 38 x 102 mm	7 ¹ / ₄ in 184 mm
50-5540	Small	1 ¹ / ₂ x 3 in 38 x 76 mm	6 ³ / ₄ in 171 mm
50-5541	Medium	1 ¹ / ₂ x 3 ¹ / ₂ in 38 x 89 mm	6 ³ / ₄ in 171 mm
50-5542	Large	1 ¹ / ₂ x 4 in 38 x 102 mm	6 ³ / ₄ in 171 mm



52-0799I

Lateral Vaginal Wall Retractor

CODE	DESCRIPTION	BLADE	LENGTH
52-0799I	Insulated	1 x 2 ¹ / ₂ in 25 x 64 mm	10 ³ / ₄ in 270 mm
52-0799E	Ebonized	1 x 2 ¹ / ₂ in 25 x 64 mm	10 ³ / ₄ in 270 mm
52-0799		1 x 2 ¹ / ₂ in 25 x 64 mm	10 ³ / ₄ in 270 mm

Vaginal



52-2020

Sims Vaginal Retractor

Hollow Grip Retractor

CODE	DESCRIPTION	LENGTH	
52-2020	Small	2½ x 1 in	64 x 25 mm
52-2021	Medium	3 x 1¼ in	76 x 32 mm
52-2022	Large	3½ x 1½ in	89 x 38 mm



Weinberg Vagotomy Retractor

CODE	DESCRIPTION	DIMENSIONS		LENGTH			
23-5917	Double-Ended	2 x 2½ in	51 x 38 mm	3½ in x 6¼ in	89 x 159 mm	9½ in	241 mm

Vascular



Garrett Multi Purpose Peripheral Vascular Retractor

CODE	DESCRIPTION	TOTAL OPENING		BLADE WIDTH		BLADE DEPTH		LENGTH	
50-8015	Self-Retaining, with Three Blades	3½ in	89 mm	1½ in	38 mm	1¼ in	32 mm	7¼ in	184 mm



Ochsner Vascular Retractor

With Swiveling Blades, Self-Retaining and Flexible Arms

CODE	TOTAL OPENING	BLADE WIDTH		BLADE DEPTH		ARM LENGTH	LENGTH
50-8016	5½ in 140 mm	1 in	25 mm	2 in	51 mm	¾ in 83 mm	8 in 203 mm

Vascular (Vision)

Complete Expanded Vision Vascular System

CODE	DESCRIPTION	DIMENSIONS		QTY
59-8865	Includes The Following Items:			
59-8802	Table Clamp w/ Vertical Post			1
59-8803	Retractor Clamp			10
59-8804	Extension Arm, Hinged			1
59-8805	Vision Frame			1
59-8807	Mayo Swivel	2 ³ / ₄ x 2 in	70 x 51 mm	2
59-8808	Mayo Swivel	3 ¹ / ₂ x 2 in	89 x 51 mm	1
59-8809	Deaver Swivel	2 ³ / ₄ x 4 ¹ / ₂ in	70 x 114 mm	1
59-8811	Harrington "Sweetheart"	2 x 5 in	51 x 127 mm	1
59-8815	Malleable Swivel, Perforated	3 x 6 in	76 x 152 mm	1
59-8816	Malleable Swivel, Perforated	3 x 6 ¹ / ₂ in	76 x 165 mm	1
59-8818	Fence Swivel, Perforated	4 x 6 in	102 x 152 mm	1
59-8820	Splanchnic Swivel	2 x 6 in	51 x 152 mm	1
59-8821	Splanchnic Swivel	2 x 6 in	51 x 152 mm	1
59-8824	Renal Swivel	1 x 6 in	25 x 151 mm	2
59-8801	Post Coupling			1
59-8828	Sterilization Case			1

Note: Individual components are available, in single quantities, by referencing their unique product code upon ordering.



55-9075

Vascular Spring

CODE	DESCRIPTION	LENGTH	
55-9075	Small	3 ¹ / ₂ in	88 mm
55-9074	Large	5 ¹ / ₄ in	133 mm

Vein



20-1708

Cushing Vein Retractor

CODE	DESCRIPTION	BLADE	LENGTH	
50-1020	Vein Retractor	13 x 10 mm	9 in	229 mm
50-1022	Vein Retractor	9 x 6 mm	7 ³ / ₄ in	197 mm
20-1750	Fenestrated Handle	11 mm	9 in	229 mm
20-1752	Fenestrated Handle	11 mm	14 in	356 mm

Vessel



Tip

Malis® Vessel Supporter

CODE	DESCRIPTION	LENGTH	
80-1534	Titanium Handle, Stainless Steel Shaft, 2 Prong	7 ³ / ₈ in	187 mm



Scan the code above to learn more about our Spine portfolio.

Spine Portfolio



symmetry surgical™

Spine



Biopsy Needles	2	Knife Handles	84
Bone Waxers	2	Knives	84
Calipers	2	Mallets	84
Chisels	3	Osteotomes	86
Containers	7	Packers	95
Curettes	13	Pins	95
Cutters	38	Probes	95
Dissectors	38	Rasps	96
Distractors	42	Retractors	97
Dowel Instruments	43	Rongeurs	136
Drills	45	Screws	185
Drivers	47	Spreaders	185
Elevators	48	Sterilizing Case Containers	187
Files	58	Suction Tubes	188
Forceps	58	Tamps	190
Gauges	62	Spine Pliers	191
Gouges	63	Trephines	192
Holder	66	Wire and Pin Cutters	192
Hooks	67	Wire Twisters	195
Impactors	69	Wrenches	195
Kits	72		

Questions? Contact us at customerservice@symmetrysurgical.com or learn more at symmetrysurgical.com

The Surgical Instrument Desk Reference

How to Use Our Catalog

The Symmetry Surgical catalog is designed with you in mind, to be your trusted resource for surgical instrumentation. We took great care in creating an easy-to-use, robust catalog and we think you'll be pleased with the design as you become more familiar with our broad portfolio.

Layout

The catalog is organized by surgical specialty *and* product function.

And we know that it is difficult to pick up an instrument and know what specialty it's listed in. To make your job easier, we've sorted the instruments in our portfolio by surgical function, too, including Energy, Laparoscopic, Retractors and Sterilization Solutions.

U.S. Customer Service

Your Symmetry Surgical Customer Service team wants to make ordering surgical instruments the easiest part of your day. We accept orders via phone, fax, email, our website, Global Healthcare Exchange (GHX) and through the mail.

PHONE

1.800.251.3000

(Available Monday through Friday, 8:30 AM–6:30 PM EST)

FAX

1.800.342.3272

EMAIL

customerservice@symmetrysurgical.com

ONLINE

symmetrysurgical.com

MAILING ADDRESS

Symmetry Surgical
Attn: Customer Service
3034 Owen Drive
Antioch, TN 37013

The Surgical Instrument Desk Reference

International Customer Service

PHONE

Symmetry Surgical Switzerland GmbH
+41 (0) 52 557 59 00
(Available Monday through Friday, 7:00-16:00 GMT)

Symmetry Surgical, Inc., USA
1.615.964.5672
(Available Monday through Friday, 8:30 AM–6:30 PM EST)

FAX

Symmetry Surgical Switzerland GmbH
+41 (0) 52 557 59 99

EMAIL

customerservice@symmetrysurgical.com
internationalorders@symmetrysurgical.com

ONLINE

symmetrysurgical.com

MAILING ADDRESS

Symmetry Surgical Switzerland GmbH
Bühlstrasse 27
CH-8200 Schaffhausen
Switzerland

Symmetry Surgical, Inc.
3034 Owen Drive
Antioch, TN 37013

INTERNATIONAL PAYMENT TERMS/RETURN GOODS POLICY/INSTRUMENT REPAIR & RESTORE PROGRAM/LITERATURE REQUESTS

Please contact your local distributor. Locate a local distributor contact, International Customer Service at +41 (0) 52 557 59 00 or 1.615.964.5672 (US).

Cardiovascular/Thoracic

Energy

Ear, Nose & Throat

General

Laparoscopic

Neurology

Obesity

OB/GYN

Ophthalmology

Orthopedics & Arthroscopy

Pediatrics

Rectal

Retractors

Spine

Urology

Sterilization Solutions

Alphabetical & Numeric Indexes

Biopsy Needles (Vertebral)

Craig Vertebral Body Biopsy

CODE	DESCRIPTION
24-2506	Vertebral Body Biopsy
24-2505	Vertebral Body Biopsy
24-2504	Vertebral Body Biopsy

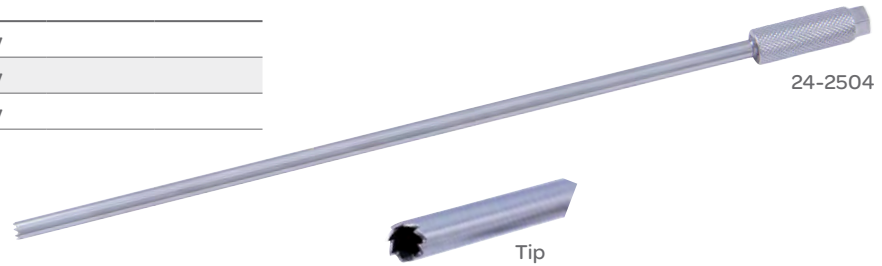

Bone Waxers (Cervical)

Cervical Bone Waxer

CODE	DESCRIPTION	WORKING DISTANCE	TOTAL LENGTH
46-2648	XL Cervical	4 $\frac{1}{10}$ in 104 mm	9 $\frac{1}{2}$ in 240 mm

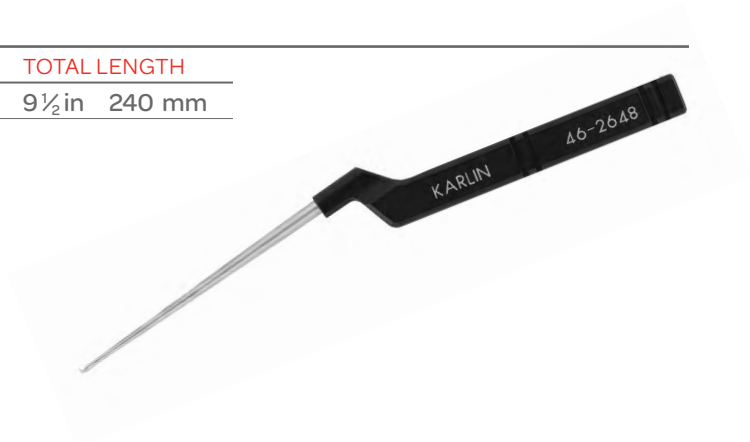

Calipers (ACF)

ACF Caliper

CODE	DESCRIPTION
59-0120	Caliper



Chisels (Bone)

Bone Chisel

CODE	DESCRIPTION
29-0401	#3, Stout



Chisels (Cervical)

Cervical Chisel

CODE	BLADE WIDTH	LENGTH
18-1013	4 mm	7 in 178 mm



Chisels (Lamina)

Derrico Lamina Chisel

CODE	BLADE WIDTH	LENGTH
18-1010	½ in 13 mm	7½ in 191 mm



Chisels (Spinal)

Spinal Fusion Chisel

CODE	DESCRIPTION	BLADE WIDTH	LENGTH
67-7001	Straight	15/64 in 0.6 mm	10½ in 267 mm



Chisels

Alexander Chisel

CODE	DESCRIPTION	BLADE WIDTH	LENGTH
28-2606	Straight	$\frac{1}{4}$ in 6 mm	7 in 178 mm



Bishop Chisel

CODE	DESCRIPTION	BLADE WIDTH	LENGTH
27-6004	Chisel	$\frac{1}{8}$ in 4 mm	6 in 152 mm



Chisel

CODE	DESCRIPTION	BLADE WIDTH	LENGTH
18-1011	Straight	$\frac{15}{64}$ in 0.6 mm	9 $\frac{1}{2}$ in 241 mm
67-7018	Straight	$\frac{3}{4}$ in 19 mm	9 $\frac{1}{2}$ in 241 mm



18-1011

Hibbs Chisel

CODE	DESCRIPTION	BLADE WIDTH	LENGTH
28-5006	Straight	$\frac{1}{4}$ in 6 mm	9 $\frac{1}{2}$ in 241 mm
28-5010	Straight	$\frac{3}{8}$ in 10 mm	9 $\frac{1}{2}$ in 241 mm
28-5012	Straight	$\frac{1}{2}$ in 12 mm	9 $\frac{1}{2}$ in 241 mm
28-5016	Straight	$\frac{5}{8}$ in 16 mm	9 $\frac{1}{2}$ in 241 mm
28-5020	Straight	$\frac{3}{4}$ in 19 mm	9 $\frac{1}{2}$ in 241 mm
28-5025	Straight	1 in 25 mm	9 $\frac{1}{2}$ in 241 mm
28-5032	Straight	1 $\frac{1}{4}$ in 32 mm	9 $\frac{1}{2}$ in 241 mm
28-5056	Curved	$\frac{1}{4}$ in 6 mm	9 $\frac{1}{2}$ in 241 mm
28-5062	Curved	$\frac{1}{2}$ in 12 mm	9 $\frac{1}{2}$ in 241 mm
28-5070	Curved	$\frac{3}{4}$ in 19 mm	9 $\frac{1}{2}$ in 241 mm
28-5075	Curved	1 in 25 mm	9 $\frac{1}{2}$ in 241 mm

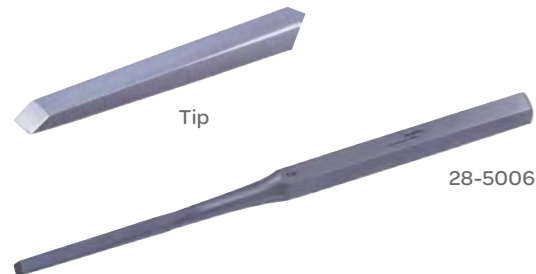

28-5006

Chisels

Lexer Chisel

CODE	DESCRIPTION	BLADE WIDTH	LENGTH
28-5407	Chisel	¼ in 6 mm	7 in 178 mm
28-5412	Chisel	⅜ in 10 mm	7 in 178 mm
28-5410	Chisel	½ in 12 mm	7 in 178 mm
28-5433	Chisel	10 mm	8 ⅝ in 219 mm
28-5435	Chisel	15 mm	8 ⅝ in 219 mm
28-5439	Chisel	30 mm	8 ⅝ in 219 mm



28-5407

Magnum Straight Curved Chisel Set

Set of Six, Curved

CODE	TIP WIDTH	HANDLE DIAMETER	LENGTH
46-3110	Set Includes:		
46-3111	6 mm	1 ¼ in 32 mm	10 ¾ in 273 mm
46-3112	10 mm	1 ¼ in 32 mm	10 ¾ in 273 mm
46-3113	15 mm	1 ¼ in 32 mm	10 ¾ in 273 mm
46-3114	20 mm	1 ¼ in 32 mm	10 ¾ in 273 mm
46-3115	25 mm	1 ¼ in 32 mm	10 ¾ in 273 mm
46-3116	30 mm	1 ¼ in 32 mm	10 ¾ in 273 mm
46-3107	Magnum Instrument Case for 6 Chisels		



46-3111

Magnum Straight Chisel Set

Set of Six, Straight

CODE	TIP WIDTH	HANDLE DIAMETER	LENGTH
46-3100	Set Includes:		
46-3101	6 mm	1 ¼ in 32 mm	10 ¾ in 273 mm
46-3102	10 mm	1 ¼ in 32 mm	10 ¾ in 273 mm
46-3103	15 mm	1 ¼ in 32 mm	10 ¾ in 273 mm
46-3104	20 mm	1 ¼ in 32 mm	10 ¾ in 273 mm
46-3105	25 mm	1 ¼ in 32 mm	10 ¾ in 273 mm
46-3106	30 mm	1 ¼ in 32 mm	10 ¾ in 273 mm
46-3107	Magnum Instrument Case for 6 Chisels		



46-3101

Chisels

Puka Chisel

CODE	NO.	LENGTH
18-1014	#1	4 in 102 mm
67-7003	#2	11 in 279 mm



18-1014

Stiletto Chisel

CODE	DESCRIPTION	TIP SIZE	LENGTH
46-3083	Curved	½ in 6 mm	8½ in 216 mm

Stiletto Chisel Set

CODE	DESCRIPTION	TIP SIZE
46-3070	Set Includes:	
46-3071	Straight	¼ in 6 mm
46-3072	Straight	⅜ in 10 mm
46-3073	Straight	½ in 13 mm
46-3074	Straight	⅝ in 16 mm
46-3075	Straight	¾ in 19 mm
46-3076	Case for Straight Stiletto Chisels	

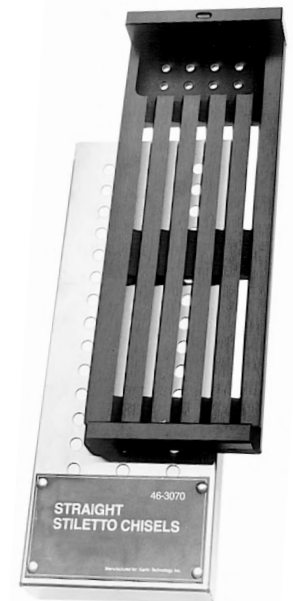

Chisels

Stille Chisel

CODE	DESCRIPTION	TIP SIZE	LENGTH
28-4320	Straight	20 mm	8 in 203 mm
28-4325	Straight	25 mm	8 in 203 mm

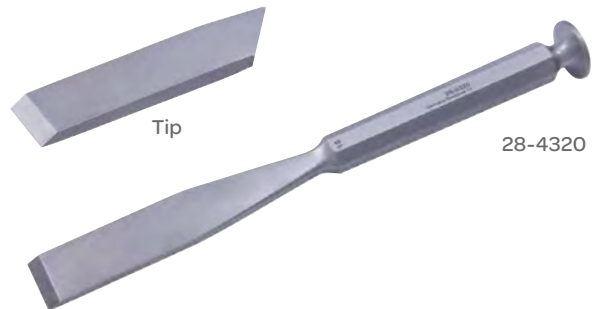

US Army Chisel

CODE	TIP SIZE	LENGTH
28-2006	¼ in 6 mm	6¼ in 159 mm
28-2012	½ in 12 mm	6¼ in 159 mm
28-2018	¾ in 18 mm	6¼ in 159 mm

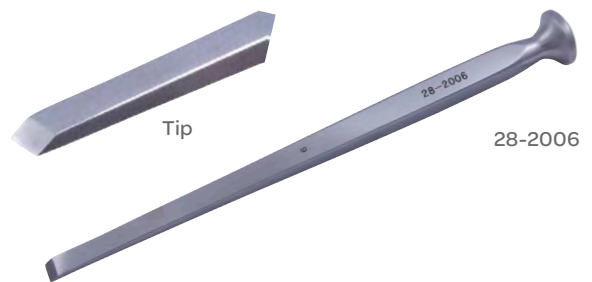

Containers (Accessories)

Silicone Retainer Bracket

CODE	DESCRIPTION	LENGTH
2-8109	Ideal for Rectangular Geometry	1½ x 2 in 38 x 51 mm
2-8110	Ideal for Rectangular Geometry	3 x 2 in 76 x 51 mm
2-8105	Expandable, Ideal for Rectangular Geometry	3 x 2 in 76 x 51 mm

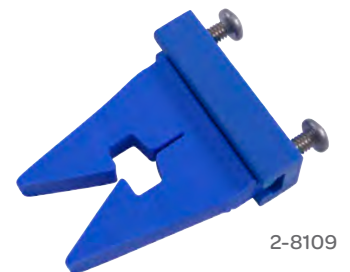

Containers (Silicone Support Bracket)

Silicone Support Bracket

CODE	DESCRIPTION	LENGTH
2-8108	Ideal for Round Geometry	3 x 2 in 76 x 51 mm
2-8112	Ideal for Rectangular Geometry	3 x 2 in 76 x 51 mm



2-8108

Containers (Sterilizing Case)

Case for Curved Stiletto Chisels

CODE	DESCRIPTION	LENGTH
46-3086	Case for Chisels	9 in 228 mm

Case K Sterilizing

CODE	DESCRIPTION	DEPTH	WIDTH	LENGTH
50-1664	Crockard™ Case K Sterilizing	7¼ in 184 mm	10½ in 266 mm	18 in 457 mm



Containers (Sterilizing Case)

Craig Vertebral Biopsy Case

CODE	DESCRIPTION
24-2510	Vertebral Biopsy Case

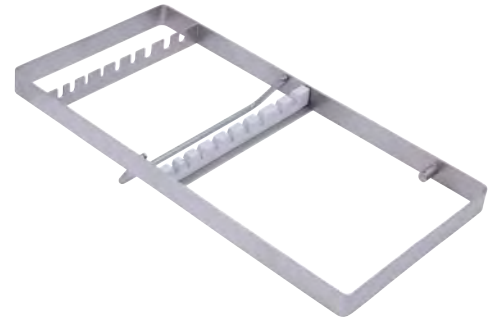

Gouge and Osteotome Case

CODE	WIDTH	DEPTH	LENGTH
21-2500	6 7/8 in 175 mm	2 1/4 in 57 mm	9 in 229 mm



Instrument Case for Anterior Cervical Fusion Instruments

CODE	DESCRIPTION
21-1001	For use with 80-1004, Anterior Fusion Kit



Containers (Sterilizing Case)

Lumbar Set Container

CODE	DESCRIPTION
59-1700	For Use with Ultra™ Lumbar Kit

Magnum Ring Curette

CODE	DESCRIPTION
46-3407	PG Magnum Sterilizing Case (12), Holds 12 Curettes. For Use with 46-3400



Microsect® Curette Tray

CODE	DESCRIPTION
47-5023	Microsect® Curette Tray



Osseous Dissection Instruments Sterilizing Case

CODE	DESCRIPTION
46-2613	For Use with Micro Osseous Dissection Instruments



Containers (Sterilizing Case)

Spinal Curette Storage and Sterilizing Case

CODE	DESCRIPTION	WIDTH		LENGTH	
21-1022	Holds Nine Sizes of Curettes	7¼ in	184 mm	9¾ in	248 mm
21-1003	Holds Nine Sizes of Curettes	7¼ in	184 mm	11¾ in	299 mm



Sterilizing and Carrying Case

CODE	DESCRIPTION	WIDTH		DEPTH	
21-1020	Holds 8 Gouges or Osteotomes	8⅞ in	225 mm	1¼ in	32 mm



Containers (Sterilizing Case)

Sterilizing O.R. Display Case

CODE	DESCRIPTION	LENGTH		WIDTH	
46-3003	Sterilizing O.R. Display Case for use with the Spondylophyte Impaction Set or four (4) straight handled instruments and a black 90° Dural Suction Retractor. Keeper Blade holds instruments in place.	10 in	250 mm	4½ in	110 mm



Instruments not included.

Storage/Sterilizing Case for 12 XL Magnum Instruments

CODE	DESCRIPTION	LENGTH	
46-3222	Double sided	13½ in	342 mm



Curettes (Bone)

Bone Curette

CODE	DESCRIPTION	CUP	LENGTH
29-7076	Straight	3.6 mm	10 in 254 mm
29-7077	Straight	4.4 mm	10 in 254 mm
29-7078	Straight	5.2 mm	10 in 254 mm
29-7079	Straight	6 mm	10 in 254 mm
29-7070	Angled	3.6 mm	10 in 254 mm
29-7071	Angled	4.4 mm	10 in 254 mm
29-7072	Angled	5.2 mm	10 in 254 mm
29-7073	Angled	6 mm	10 in 254 mm



Bone Curette

CODE	DESCRIPTION	CUP	LENGTH
29-4902	Oval	2 mm	7 in 178 mm
29-4906	Oval	6 mm	7 in 178 mm

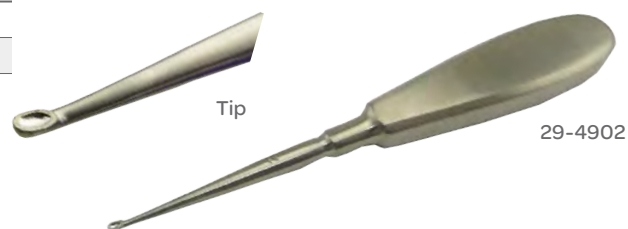

Jansen Bone Curette

Double-Ended

CODE	DESCRIPTION	LENGTH
29-8372	2.5 mm and 3 mm Oval Tips, Angled	6 in 152 mm

Martini Bone Curette

Double-Ended, Round

CODE	DESCRIPTION	LENGTH
29-8010	#00/0	5½ in 140 mm
29-8011	#0/1	5½ in 140 mm
29-8012	#1/2	5½ in 140 mm



Curettes (Bone)

Spratt Bone Curette

Oval, Delicate Pattern

CODE	DESCRIPTION	LENGTH
29-6333	#000	7 1/8 in 181 mm
29-6342	#00	7 1/8 in 181 mm
29-6350	#0	7 1/8 in 181 mm
29-6351	#1	7 1/8 in 181 mm
29-6352	#2	7 1/8 in 181 mm
29-6353	#3	7 1/8 in 181 mm
29-6354	#4	7 1/8 in 181 mm

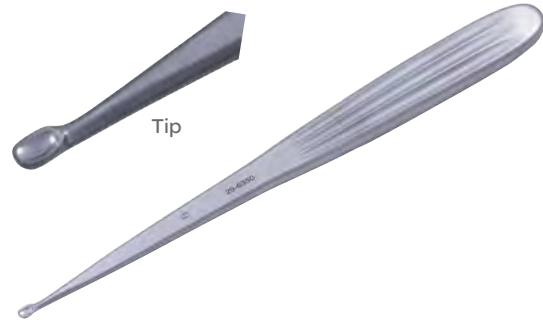

Williger Bone Curette

CODE	DESCRIPTION	LENGTH
29-8312	Double-Ended, 3 mm and 4 mm	5 1/2 in 140 mm



Curettes (Cervical)

Cervical Axial Curette

CODE	DESCRIPTION	LENGTH
57-4919	Straight Down, #000000	9 in 229 mm
57-4908	Angled Down, #00000	9 in 229 mm
57-4907	Angled Down, #000000	9 in 229 mm



Cervical Axial Curette

CODE	DESCRIPTION	LENGTH
57-4901	Forward Angled, #000000	9 in 229 mm
57-4902	Forward Angled, #00000	9 in 229 mm

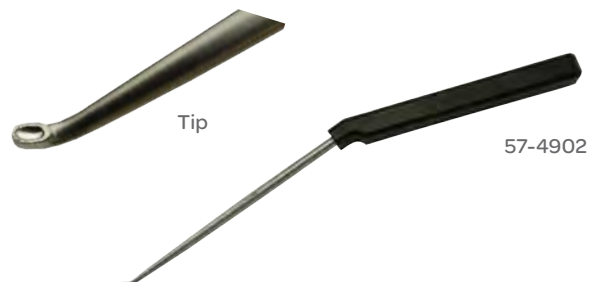

Curettes (Cervical)

Cervical Axial Curette

CODE	DESCRIPTION	LENGTH
57-4932	Forward Down, #00000	9 in 229 mm
57-4936	Forward Down, #0	9 in 229 mm



57-4936

Cervical Axial Curette

CODE	DESCRIPTION	LENGTH
57-4914	Forward Straight, #00000	9 in 229 mm



Tip

Sales Team Training

When it comes to training our sales force, Symmetry Surgical's resources are truly exceptional! Each sales team member is clinically trained as a surgical instrument specialist – receiving comprehensive, hands-on clinical training from our staff, our surgeon inventors and our product specialists.

Legacy of Innovation

Many of Symmetry Surgical's innovations have come directly from practicing clinicians. We collaborate with our customers to identify and solve problems they face in their clinical practice – and pride ourselves on bringing the best solution forward.

Our Portfolio

With a robust pipeline and broad portfolio, Symmetry Surgical boasts one of the most comprehensive instrument and medical device offerings in the marketplace today. A leader in the surgical instrument market, we are 100% focused on surgical instrumentation. Our breadth of product line enables our customers to depend on us for virtually all of their surgical instrumentation needs.

Curettes (Cervical)



Cervical Microdiscectomy, Set of 24 Instruments

CODE	DESCRIPTION	DESCRIPTION	LENGTH
46-3150	Set Includes:		8 ½ in 216 mm
46-3161	Cervical Microdiscectomy Curette	Backward Straight, 0	8 ½ in 216 mm
46-3162	Cervical Microdiscectomy Curette	Backward Straight, 00	8 ½ in 216 mm
46-3163	Cervical Microdiscectomy Curette	Backward Straight, 000	8 ½ in 216 mm
46-3164	Cervical Microdiscectomy Curette	Backward Straight, 0000	8 ½ in 216 mm
46-3166	Cervical Microdiscectomy Curette	Backward Angle, 0	8 ½ in 216 mm
46-3167	Cervical Microdiscectomy Curette	Backward Angle, 00	8 ½ in 216 mm
46-3168	Cervical Microdiscectomy Curette	Backward Angle, 000	8 ½ in 216 mm
46-3169	Cervical Microdiscectomy Curette	Backward Angle, 0000	8 ½ in 216 mm
46-3151	Cervical Microdiscectomy Curette	Forward Straight, 0	8 ½ in 216 mm
46-3152	Cervical Microdiscectomy Curette	Forward Straight, 00	8 ½ in 216 mm
46-3153	Cervical Microdiscectomy Curette	Forward Straight, 000	8 ½ in 216 mm
46-3154	Cervical Microdiscectomy Curette	Forward Straight, 0000	8 ½ in 216 mm
46-3156	Cervical Microdiscectomy Curette	Forward Angle, 0	8 ½ in 216 mm
46-3157	Cervical Microdiscectomy Curette	Forward Angle, 00	8 ½ in 216 mm
46-3158	Cervical Microdiscectomy Curette	Forward Angle, 000	8 ½ in 216 mm
46-3159	Cervical Microdiscectomy Curette	Forward Angle, 0000	8 ½ in 216 mm
46-3165	Cervical Cortical Bone Cutter	Backward Straight	8 ½ in 216 mm
46-3170	Cervical Cortical Bone Cutter	Backward Angle	8 ½ in 216 mm
46-3155	Cervical Cortical Bone Cutter	Forward Straight	8 ½ in 216 mm
46-3160	Cervical Cortical Bone Cutter	Forward Angle	8 ½ in 216 mm
46-3171	Micro Nerve Hook		8 ½ in 216 mm
46-3172	Ultra™ Micro Nerve Hook		8 ½ in 216 mm
46-3173	Cervical Bone Waxer		8 ½ in 216 mm
46-3175	Storage/Sterilizing Case, For 12 Instruments 2 Provided with Kit		

Curettes (Cervical)

Karlin™ XL Cervical Curette

CODE	DESCRIPTION	LENGTH
46-2626	Forward Straight, 0	4 1/10 x 3/5 x 9 1/2 in 104 x 15 x 241 mm
46-2627	Forward Straight, 00	4 1/10 x 3/5 x 9 1/2 in 104 x 15 x 241 mm
46-2628	Forward Straight, 000	4 1/10 x 3/5 x 9 1/2 in 104 x 15 x 241 mm
46-2629	Forward Straight, 0000	4 1/10 x 3/5 x 9 1/2 in 104 x 15 x 241 mm
46-2631	Forward Angle, 0	4 1/10 x 3/5 x 9 1/2 in 104 x 15 x 241 mm
46-2632	Forward Angle, 00	4 1/10 x 3/5 x 9 1/2 in 104 x 15 x 241 mm
46-2633	Forward Angle, 000	4 1/10 x 3/5 x 9 1/2 in 104 x 15 x 241 mm
46-2634	Forward Angle, 0000	4 1/10 x 3/5 x 9 1/2 in 104 x 15 x 241 mm
46-2636	Backward Straight, 0	4 1/10 x 3/5 x 9 1/2 in 104 x 15 x 241 mm
46-2637	Backward Straight, 00	4 1/10 x 3/5 x 9 1/2 in 104 x 15 x 241 mm
46-2638	Backward Straight, 000	4 1/10 x 3/5 x 9 1/2 in 104 x 15 x 241 mm
46-2639	Backward Straight, 0000	4 1/10 x 3/5 x 9 1/2 in 104 x 15 x 241 mm
46-2645	Backward Angle	4 1/10 x 3/5 x 9 1/2 in 104 x 15 x 241 mm
46-2641	Backward Angle, 0	4 1/10 x 3/5 x 9 1/2 in 104 x 15 x 241 mm
46-2642	Backward Angle, 00	4 1/10 x 3/5 x 9 1/2 in 104 x 15 x 241 mm
46-2643	Backward Angle, 000	4 1/10 x 3/5 x 9 1/2 in 104 x 15 x 241 mm
46-2644	Backward Angle, 0000	4 1/10 x 3/5 x 9 1/2 in 104 x 15 x 241 mm



46-2626

Curettes (Cone Ring)

Cone Ring Curette

CODE	DESCRIPTION	RING I.D.	LENGTH
23-1013	#1, Straight	5/16 in 8 mm	9 in 229 mm
23-1014	#2, Straight	1/4 in 6 mm	9 in 229 mm
23-1015	#3, Straight	1/8 in 3 mm	9 in 229 mm
23-1020C	Angled 5°	5/16 in 8 mm	9 in 229 mm
23-1021C	Angled 30°	5/16 in 8 mm	9 in 229 mm

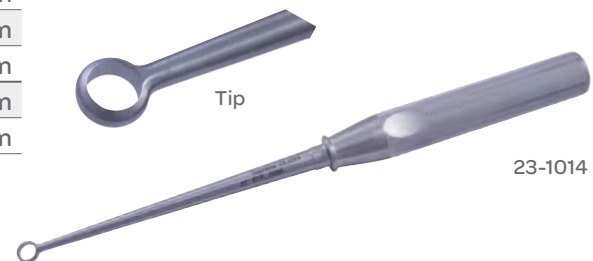

23-1014

Curettes (Cervical)

Cone Ring Curette

CODE	DESCRIPTION	DESCRIPTION	LENGTH
57-4703	Straight	9 mm	9 in 229 mm
57-4713	Angled	9 mm	9 in 229 mm

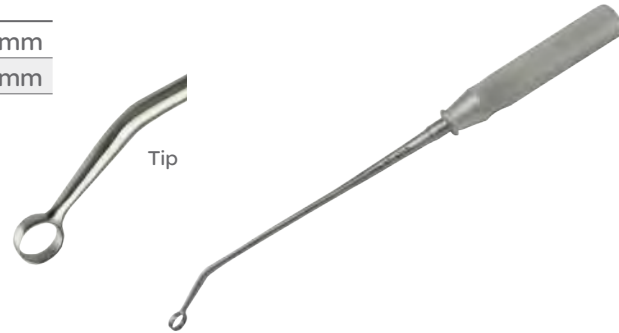

Curettes

Karlin™ XL Magnum Cup Curette

CODE	DESCRIPTION	DESCRIPTION	LENGTH
46-3226	Forward Straight	7 mm	13 ¼ in 337 mm
46-3227	Forward Straight	9 mm	13 ¼ in 337 mm
46-3228	Forward Straight	11 mm	13 ¼ in 337 mm
46-3229	Forward Straight	13 mm	13 ¼ in 337 mm
46-3230	Forward Straight	15 mm	13 ¼ in 337 mm
46-3236	Forward Straight	17 mm	13 ¼ in 337 mm
46-3237	Forward Straight	19 mm	13 ¼ in 337 mm
46-3231	Forward Angle	7 mm	13 ¼ in 337 mm
46-3232	Forward Angle	9 mm	13 ¼ in 337 mm
46-3233	Forward Angle	11 mm	13 ¼ in 337 mm
46-3234	Down Pushing	7 mm	13 ¼ in 337 mm
46-3235	Down Pushing	9 mm	13 ¼ in 337 mm



Curettes



46-3410

Magnum Cup Curette Kit

PG - Set of 12, Large Capacity Cup, Sizes Permit Rapid Tissue Removal

CODE	DESCRIPTION	DESCRIPTION	LENGTH	TOTAL LENGTH
46-3410	Set of 12 with case, includes the following:			
46-3411	Forward Straight	PG 7 mm	7 ⁴ / ₅ in 200 mm	12 ³ / ₅ in 320 mm
46-3412	Forward Straight	PG 9 mm	7 ⁴ / ₅ in 200 mm	12 ³ / ₅ in 320 mm
46-3413	Forward Straight	PG 11 mm	7 ⁴ / ₅ in 200 mm	12 ³ / ₅ in 320 mm
46-3414	Forward Straight	PG 13 mm	7 ⁴ / ₅ in 200 mm	12 ³ / ₅ in 320 mm
46-3415	Forward Straight	PG 15 mm	7 ⁴ / ₅ in 200 mm	12 ³ / ₅ in 320 mm
46-3416	Forward Straight	PG 17 mm	7 ⁴ / ₅ in 200 mm	12 ³ / ₅ in 320 mm
46-3417	Forward Straight	PG 19 mm	7 ⁴ / ₅ in 200 mm	12 ³ / ₅ in 320 mm
46-3418	Forward Angle	PG 7 mm	7 ⁴ / ₅ in 200 mm	12 ³ / ₅ in 320 mm
46-3419	Forward Angle	PG 9 mm	7 ⁴ / ₅ in 200 mm	12 ³ / ₅ in 320 mm
46-3420	Forward Angle	PG 11 mm	7 ⁴ / ₅ in 200 mm	12 ³ / ₅ in 320 mm
46-3421	Forward Down Pushing	PG 7 mm	7 ⁴ / ₅ in 200 mm	12 ³ / ₅ in 320 mm
46-3422	Forward Down Pushing	PG 9 mm	7 ⁴ / ₅ in 200 mm	12 ³ / ₅ in 320 mm

Curettes (Lumbar)

Lumbar Axial Curette

CODE	DESCRIPTION	LENGTH
57-4968	Angled Down, #000000	10 ¼ in 260 mm
57-4969	Angled Down, #00000	10 ¼ in 260 mm
57-4970	Angled Down, #0000	10 ¼ in 260 mm
57-4971	Angled Down, #000	10 ¼ in 260 mm
57-4972	Angled Down, #00	10 ¼ in 260 mm
57-4973	Angled Down, #0	10 ¼ in 260 mm



Lumbar Axial Curette

CODE	DESCRIPTION	LENGTH
57-4950	Reverse Angle Up, #000000	10 ¼ in 260 mm
57-4951	Reverse Angle Up, #00000	10 ¼ in 260 mm
57-4952	Reverse Angle Up, #0000	10 ¼ in 260 mm
57-4953	Reverse Angle Up, #000	10 ¼ in 260 mm
57-4954	Reverse Angle Up, #00	10 ¼ in 260 mm
57-4955	Reverse Angle Up, #0	10 ¼ in 260 mm



Lumbar Axial Curette

CODE	DESCRIPTION	LENGTH
57-4980	Straight Down, #000000	10 ¼ in 260 mm
57-4981	Straight Down, #00000	10 ¼ in 260 mm
57-4982	Straight Down, #0000	10 ¼ in 260 mm
57-4983	Straight Down, #000	10 ¼ in 260 mm
57-4984	Straight Down, #00	10 ¼ in 260 mm
57-4985	Straight Down, #0	10 ¼ in 260 mm



Curettes (Lumbar)

Lumbar Axial Curette

CODE	DESCRIPTION	LENGTH
57-4962	Angled Up, #000000	10 ¼ in 260 mm
57-4963	Angled Up, #00000	10 ¼ in 260 mm
57-4964	Angled Up, #0000	10 ¼ in 260 mm
57-4965	Angled Up, #000	10 ¼ in 260 mm
57-4966	Angled Up, #00	10 ¼ in 260 mm
57-4967	Angled Up, #0	10 ¼ in 260 mm



Lumbar Axial Curette

CODE	DESCRIPTION	LENGTH
57-4956	Reverse Angle Down, #000000	10 ¼ in 260 mm
57-4957	Reverse Angle Down, #00000	10 ¼ in 260 mm
57-4958	Reverse Angle Down, #0000	10 ¼ in 260 mm
57-4959	Reverse Angle Down, #000	10 ¼ in 260 mm
57-4960	Reverse Angle Down, #00	10 ¼ in 260 mm
57-4961	Reverse Angle Down, #0	10 ¼ in 260 mm



Lumbar Axial Curette

CODE	DESCRIPTION	LENGTH
57-4974	Straight Up, #000000	10 ¼ in 260 mm
57-4975	Straight Up, #00000	10 ¼ in 260 mm
57-4976	Straight Up, #0000	10 ¼ in 260 mm
57-4977	Straight Up, #000	10 ¼ in 260 mm
57-4978	Straight Up, #00	10 ¼ in 260 mm
57-4979	Straight Up, #0	10 ¼ in 260 mm



Curettes (Lumbar)

Lumbar Microdiscectomy Curette

CODE	DESCRIPTION	LENGTH
46-3133	Backwards Angle, 0	9½ in 241 mm
46-3134	Backwards Angle, 1	9½ in 241 mm
46-3135	Backwards Angle, 2	9½ in 241 mm



46-3135

Lumbar Microdiscectomy Curette

CODE	DESCRIPTION	LENGTH
46-3136	Backwards Down, 0	9½ in 241 mm
46-3137	Backwards Down, 1	9½ in 241 mm
46-3138	Backwards Down, 2	9½ in 241 mm

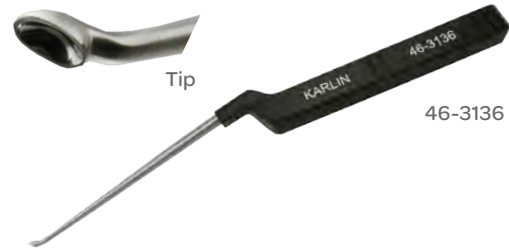

46-3136

Lumbar Microdiscectomy Curette

CODE	DESCRIPTION	LENGTH
46-3130	Backwards Straight, 0	9½ in 241 mm
46-3131	Backwards Straight, 1	9½ in 241 mm
46-3132	Backwards Straight, 2	9½ in 241 mm



46-3131

Lumbar Microdiscectomy Curette

CODE	DESCRIPTION	LENGTH
46-3124	Forward Angle, 0	9½ in 241 mm
46-3125	Forward Angle, 1	9½ in 241 mm
46-3126	Forward Angle, 2	9½ in 241 mm



46-3125

Lumbar Microdiscectomy Curette

CODE	DESCRIPTION	LENGTH
46-3127	Forward Down, 0	9½ in 241 mm
46-3128	Forward Down, 1	9½ in 241 mm
46-3129	Forward Down, 2	9½ in 241 mm



46-3128

Curettes (Lumbar)

Lumbar Microdiscectomy Curette

CODE	DESCRIPTION	LENGTH
46-3121	Forward Straight, 0	9½ in 241 mm
46-3122	Forward Straight, 1	9½ in 241 mm
46-3123	Forward Straight, 2	9½ in 241 mm



Curettes (Micro)

Micro Osseous Dissection instruments are designed for the microsurgical removal of bony, calcified or other firm tissues. These instruments can be used in conjunction with a high speed drill to thin bone before removal.

Micro Curette

Bayonet

CODE	DESCRIPTION	WORKING DISTANCE
46-2609	45° Up, 0000	3 in 76 mm
46-2608	45° Up, 000	3 in 76 mm
46-2607	45° Up, 00	3 in 76 mm



Micro Curette

Bayonet

CODE	DESCRIPTION	WORKING DISTANCE
46-2612	80° Down, 0000	3 in 76 mm
46-2611	80° Down, 000	3 in 76 mm
46-2610	80° Down, 00	3 in 76 mm



Micro Curette

Bayonet

CODE	DESCRIPTION	WORKING DISTANCE
46-2606	Straight, 0000	3 in 76 mm
46-2605	Straight, 000	3 in 76 mm



Curettes

Karlin™ Magnum Ring Curette

Ring, Extra Long Curettes, Black Handles, Lightweight

CODE	DESCRIPTION	TIP SIZE	LENGTH
46-3215	Set of six (6) includes the following:		13¼ in 337 mm
46-3216	XL Straight	6 mm	13¼ in 337 mm
46-3217	XL Straight	8 mm	13¼ in 337 mm
46-3218	XL Straight	10 mm	13¼ in 337 mm
46-3219	XL Angled	6 mm	13¼ in 337 mm
46-3220	XL Angled	8 mm	13¼ in 337 mm
46-3221	XL Angled	10 mm	13¼ in 337 mm

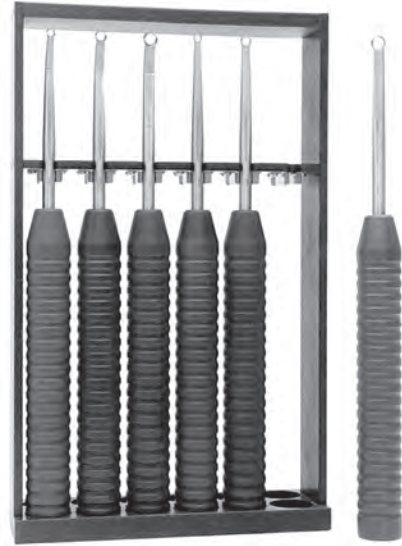

46-3215

Magnum Ring Curette

CODE	DESCRIPTION	TIP SIZE	LENGTH
46-3401	Straight	PG 6 mm	4 9/10 x 1 3/25 x 7 4/5 x 12 3/5 in 125 x 28 x 198 x 320 mm
46-3402	Straight	PG 8 mm	4 9/10 x 1 3/25 x 7 4/5 x 12 3/5 in 125 x 28 x 198 x 320 mm
46-3403	Straight	PG 10 mm	4 9/10 x 1 3/25 x 7 4/5 x 12 3/5 in 125 x 28 x 198 x 320 mm
46-3404	Angle	PG 6 mm	4 9/10 x 1 3/25 x 7 4/5 x 12 3/5 in 125 x 28 x 198 x 320 mm
46-3405	Angle	PG 8 mm	4 9/10 x 1 3/25 x 7 4/5 x 12 3/5 in 125 x 28 x 198 x 320 mm
46-3406	Angle	PG 10 mm	4 9/10 x 1 3/25 x 7 4/5 x 12 3/5 in 125 x 28 x 198 x 320 mm



46-3402

Curettes

Semmes Spinal Fusion Curette

CODE	DESCRIPTION	RING SIZE	LENGTH
29-4950	Straight	5 x 8 mm	9 in 229 mm
23-1035	Straight	4 x 7 mm	9 in 229 mm
29-4952	Full Curve	5 x 8 mm	9 in 229 mm
23-1036	Slightly Curved	4 x 7 mm	9 in 229 mm



Spinal Curette

CODE	DESCRIPTION	LENGTH
23-1081	Straight 000	11 in 279 mm
23-1082	Straight 00	11 in 279 mm
23-1083	Straight 0	11 in 279 mm
23-1084	Straight 1	11 in 279 mm
23-1085	Straight 2	11 in 279 mm
23-1086	Straight 3	11 in 279 mm
23-1087	Straight 4	11 in 279 mm
23-1088	Straight 5	11 in 279 mm
23-1089	Straight 6	11 in 279 mm

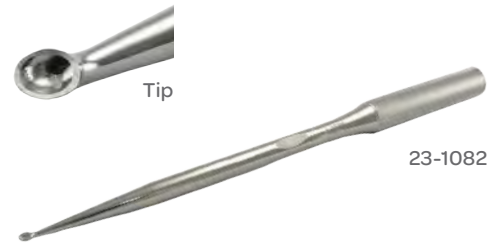

Spinal Fusion Curette

Oval

CODE	DESCRIPTION	LENGTH
29-4860	Straight #000	11 in 279 mm
29-4861	Straight #00	11 in 279 mm
29-4862	Straight #0	11 in 279 mm
29-4863	Straight #1	11 in 279 mm
29-4865	Straight #3	11 in 279 mm
29-4866	Straight #4	11 in 279 mm
29-4867	Straight #5	11 in 279 mm
29-4868	Straight #6	11 in 279 mm

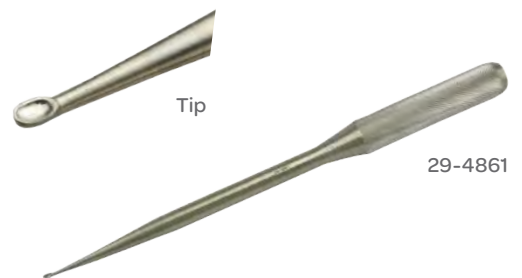

Curettes

Spinal Fusion Curette

Oval

CODE	DESCRIPTION	LENGTH
29-6010A	Angled #00000	12 in 305 mm
29-6011A	Angled #0000	12 in 305 mm
29-6012A	Angled #000	12 in 305 mm
29-6013A	Angled #00	12 in 305 mm
29-6014A	Angled #0	12 in 305 mm
29-6015A	Angled #1	12 in 305 mm
29-6016A	Angled #2	12 in 305 mm
29-6017A	Angled #3	12 in 305 mm
29-6018A	Angled #4	12 in 305 mm
29-6020A	Angled #6	12 in 305 mm

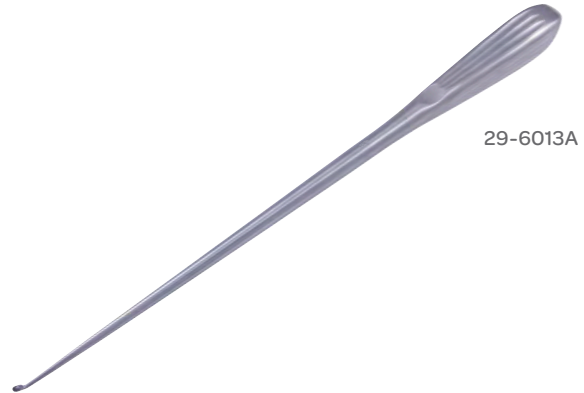

Spinal Fusion Curette

Oval

CODE	DESCRIPTION	LENGTH
29-6010	Straight #00000	12 in 305 mm
29-6011	Straight #0000	12 in 305 mm
29-6012	Straight #000	12 in 305 mm
29-6013	Straight #00	12 in 305 mm
29-6014	Straight #0	12 in 305 mm
29-6015	Straight #1	12 in 305 mm
29-6016	Straight #2	12 in 305 mm
29-6017	Straight #3	12 in 305 mm
29-6019	Straight #5	12 in 305 mm
29-6020	Straight 6	12 in 305 mm

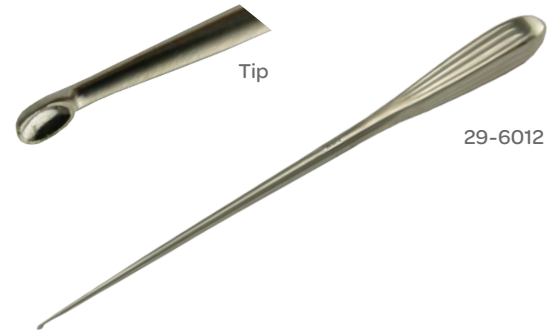

Spinal Fusion Curette

Oval

CODE	DESCRIPTION	LENGTH
29-4936	Angled #00000	8 in 203 mm
29-4937	Angled #0000	8 in 203 mm
29-4938	Angled #000	8 in 203 mm
29-4939	Angled #00	8 in 203 mm
29-4940	Angled #0	8 in 203 mm
29-4941	Angled #1	8 in 203 mm



Curettes

Spinal Fusion Curette

Oval

CODE	DESCRIPTION	LENGTH
29-5026	Straight #00000	8 in 203 mm
29-5028	Straight #000	8 in 203 mm
29-5029	Straight #00	8 in 203 mm
29-5030	Straight #0	8 in 203 mm
29-5032	Straight #2	8 in 203 mm

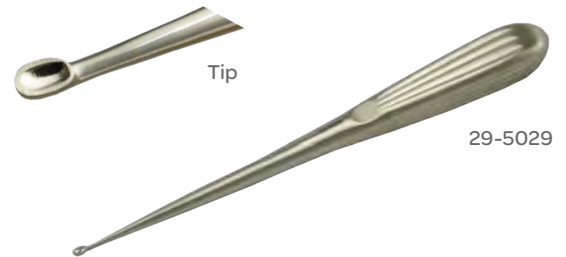

Spinal Fusion Curette

CODE	DESCRIPTION	LENGTH
23-1051	Angled 000	8 in 203 mm
23-1052	Angled 00	8 in 203 mm
23-1053	Angled 0	8 in 203 mm
23-1054	Angled, No. 1	8 in 203 mm
23-1055	Angled, No. 2	8 in 203 mm
23-1056	Angled, No. 3	8 in 203 mm
23-1057	Angled, No. 4	8 in 203 mm
23-1058	Angled, No. 5	8 in 203 mm
23-1059	Angled, No. 6	8 in 203 mm

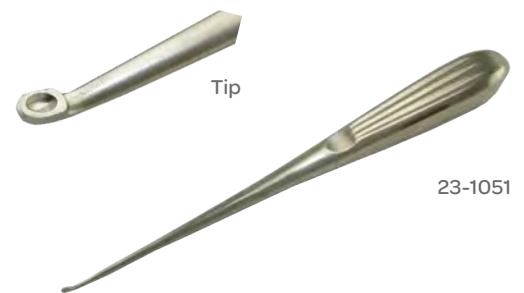

Spinal Fusion Curette

CODE	DESCRIPTION	LENGTH
23-1041	Straight 000	8 in 203 mm
23-1042	Straight 00	8 in 203 mm
23-1043	Straight 0	8 in 203 mm
23-1044	Straight, No. 1	8 in 203 mm
23-1045	Straight, No. 2	8 in 203 mm
23-1046	Straight, No. 3	8 in 203 mm
23-1047	Straight, No. 4	8 in 203 mm
23-1048	Straight, No. 5	8 in 203 mm
23-1049	Straight, No. 6	8 in 203 mm



Curettes

Spinal Fusion Curette

Oval

CODE	DESCRIPTION	LENGTH
29-5407	Reverse Angle, #00000	9 in 229 mm
29-5399	Reverse Angle, #00	9 in 229 mm
29-5400	Reverse Angle, #0	9 in 229 mm
29-5401	Reverse Angle, #1	9 in 229 mm
29-5402	Reverse Angle, #2	9 in 229 mm

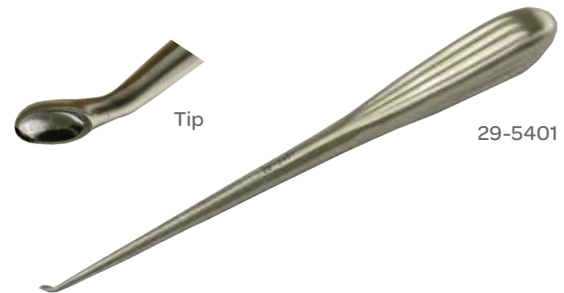

Spinal Fusion Curette

CODE	DESCRIPTION	LENGTH
23-1061	Straight 000	9 in 229 mm
23-1062	Straight 00	9 in 229 mm
23-1063	Straight 0	9 in 229 mm
23-1064	Straight, No. 1	9 in 229 mm
23-1065	Straight, No. 2	9 in 229 mm
23-1066	Straight, No. 3	9 in 229 mm
23-1067	Straight, No. 4	9 in 229 mm
23-1068	Straight, No. 5	9 in 229 mm
23-1069	Straight, No. 6	9 in 229 mm

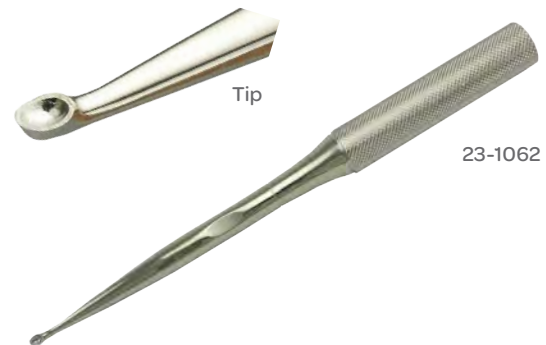

Spinal Fusion Curette

Angled, 30° Up

CODE	CUP	DESCRIPTION	LENGTH
67-7220	#000000	2 x 3.5 mm	11 in 280 mm
67-7219	#00000	2.5 x 4 mm	11 in 280 mm
67-7218	#0000	3 x 5 mm	11 in 280 mm



Curettes

Spinal Fusion Curette

Straight

CODE	CUP	DESCRIPTION	LENGTH
67-7186	#000	3.5 x 5 mm	13 in 330 mm
67-7187	#00	4 x 5.5 mm	13 in 330 mm
67-7188	#0	4.5 x 6.5 mm	13 in 330 mm
67-7189	#1	5 x 7.5 mm	13 in 330 mm
67-7190	#2	6 x 10 mm	13 in 330 mm
67-7191	#3	7 x 11 mm	13 in 330 mm
67-7192	#4	8.5 x 13 mm	13 in 330 mm
67-7193	#5	9.5 x 14.5 mm	13 in 330 mm
67-7194	#6	10.5 x 17 mm	13 in 330 mm
67-7209	#000	3.5 x 5 mm	15 in 381 mm
67-7211	#00	4 x 5.5 mm	15 in 381 mm
67-7212	#0	4.5 x 6.5 mm	15 in 381 mm
67-7221	#1	5 x 7.5 mm	15 in 381 mm
67-7213	#2	6 x 10 mm	15 in 381 mm
67-7214	#3	7 x 11 mm	15 in 381 mm
67-7215	#4	8.5 x 13 mm	15 in 381 mm
67-7216	#5	9.5 x 14.5 mm	15 in 381 mm



Bruns Curette

CODE	CUP SIZE	DESCRIPTION	LENGTH
32-3400	000	3.2 mm	9 in 229 mm
32-3401	00	3.4 mm	9 in 229 mm
32-3402	0 10 in Receiving	3.7 mm	9 in 229 mm
32-3403	1	4.7 mm	9 in 229 mm
32-3404	2	5.7 mm	9 in 229 mm
32-3405	3	7 mm	9 in 229 mm
32-3406	4	8.4 mm	9 in 229 mm
32-3407	5	8.9 mm	9 in 229 mm
32-3408	6	10.2 mm	9 in 229 mm



Curettes

Bruns Curette

CODE	DESCRIPTION	LENGTH
29-5533A	Angled #000	9 in 229 mm
29-5542A	Angled #00	9 in 229 mm
29-5550A	Angled #0	9 in 229 mm
29-5551A	Angled #1	9 in 229 mm
29-5552A	Angled #2	9 in 229 mm
29-5553A	Angled #3	9 in 229 mm
29-5554A	Angled #4	9 in 229 mm
29-5555A	Angled #5	9 in 229 mm
29-5556A	Angled #6	9 in 229 mm



Bruns Curette

CODE	DESCRIPTION	LENGTH
29-5550	Straight #0	9 in 229 mm
29-5542	Straight #00	9 in 229 mm
29-5533	Straight #000	9 in 229 mm
29-5524	Straight #0000	9 in 229 mm
29-5551	Straight #1	9 in 229 mm
29-5552	Straight #2	9 in 229 mm
29-5553	Straight #3	9 in 229 mm
29-5554	Straight #4	9 in 229 mm
29-5555	Straight #5	9 in 229 mm
29-5556	Straight #6	9 in 229 mm



Bruns Curette

Forward Angle

CODE	CUP SIZE	DESCRIPTION	LENGTH
32-3480	0000	3 mm	9 in 229 mm
32-3481	000	3.3 mm	9 in 229 mm
32-3482	00	3.9 mm	9 in 229 mm
32-3483	0	4.5 mm	9 in 229 mm
32-3484	1	5.3 mm	9 in 229 mm
32-3485	2	6 mm	9 in 229 mm
32-3486	3	7.2 mm	9 in 229 mm
32-3487	4	8.2 mm	9 in 229 mm
32-3488	5	9.8 mm	9 in 229 mm
32-3489	6	12.5 mm	9 in 229 mm



Curettes

Bruns Curette

Reverse Angle

CODE	CUP SIZE	DESCRIPTION	LENGTH
32-3490	0000	3 mm	9 in 229 mm
32-3491	000	3.2 mm	9 in 229 mm
32-3492	00	3.4 mm	9 in 229 mm
32-3493	0	3.7 mm	9 in 229 mm
32-3494	1	4.7 mm	9 in 229 mm
32-3495	2	5.7 mm	9 in 229 mm
32-3496	3	7 mm	9 in 229 mm
32-3497	4	8.4 mm	9 in 229 mm
32-3498	5	8.9 mm	9 in 229 mm
32-3499	6	10.2 mm	9 in 229 mm



Bruns Curette

Straight

CODE	CUP SIZE	DESCRIPTION	LENGTH
32-3470	0000	3 mm	9 in 229 mm
32-3471	000	3.2 mm	9 in 229 mm
32-3472	00	3.4 mm	9 in 229 mm
32-3473	0	3.7 mm	9 in 229 mm
32-3474	1	4.7 mm	9 in 229 mm
32-3475	2	5.7 mm	9 in 229 mm
32-3476	3	7 mm	9 in 229 mm
32-3477	4	8.4 mm	9 in 229 mm
32-3478	5	8.9 mm	9 in 229 mm
32-3479	6	10.2 mm	9 in 229 mm



Bruns Curette

Angled, Oval

CODE	DESCRIPTION	LENGTH
29-5123A	#00000	6 3/4 in 171 mm
29-5124A	#0000	6 3/4 in 171 mm
29-5133A	#000	6 3/4 in 171 mm
29-5142A	#00	6 3/4 in 171 mm
29-5150A	#0	6 3/4 in 171 mm
29-5151A	#1	6 3/4 in 171 mm
29-5152A	#2	6 3/4 in 171 mm
29-5153A	#3	6 3/4 in 171 mm
29-5154A	#4	6 3/4 in 171 mm
29-5155A	#5	6 3/4 in 171 mm
29-5156A	#6	6 3/4 in 171 mm

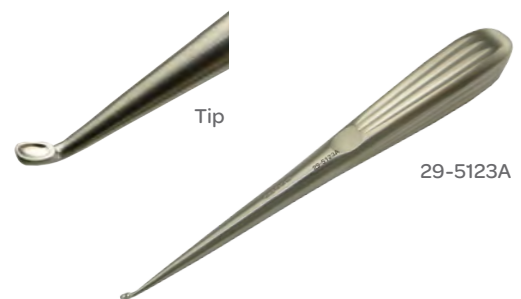

Curettes

Bruns Curette

Straight, Oval

CODE	DESCRIPTION	LENGTH
29-5123	#00000	6¾ in 171 mm
29-5124	#0000	6¾ in 171 mm
29-5133	#000	6¾ in 171 mm
29-5142	#00	6¾ in 171 mm
29-5150	#0	6¾ in 171 mm
29-5151	#1	6¾ in 171 mm
29-5152	#2	6¾ in 171 mm
29-5153	#3	6¾ in 171 mm
29-5154	#4	6¾ in 171 mm
29-5155	#5	6¾ in 171 mm
29-5156	#6	6¾ in 171 mm

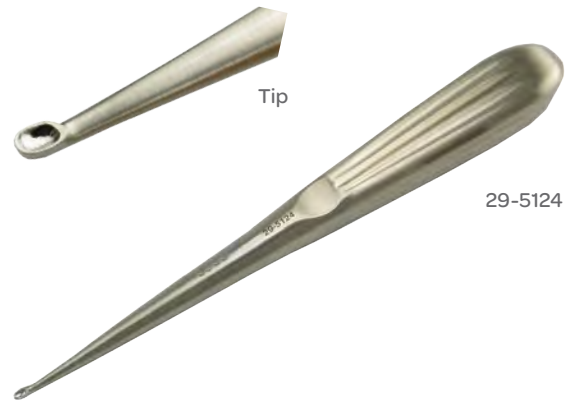

Bruns Curette

Angled, Oval

CODE	DESCRIPTION	LENGTH
29-5359	#000000	9 in 229 mm
29-5360	#00000	9 in 229 mm
29-5364	#0000	9 in 229 mm
29-5373	#000	9 in 229 mm
29-5382	#00	9 in 229 mm
29-5390	#0	9 in 229 mm
29-5391	#1	9 in 229 mm
29-5392	#2	9 in 229 mm
29-5393	#3	9 in 229 mm
29-5394	#4	9 in 229 mm
29-5395	#5	9 in 229 mm
29-5396	#6	9 in 229 mm

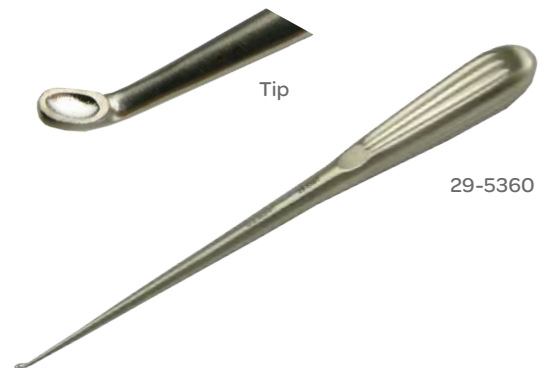

Curettes

Bruns Curette

Straight, Oval

CODE	DESCRIPTION	LENGTH	
29-5320	#00000	9 in	229 mm
29-5324	#0000	9 in	229 mm
29-5333	#000	9 in	229 mm
29-5342	#00	9 in	229 mm
29-5350	#0	9 in	229 mm
29-5351	#1	9 in	229 mm
29-5352	#2	9 in	229 mm
29-5353	#3	9 in	229 mm
29-5354	#4	9 in	229 mm
29-5355	#5	9 in	229 mm
29-5356	#6	9 in	229 mm

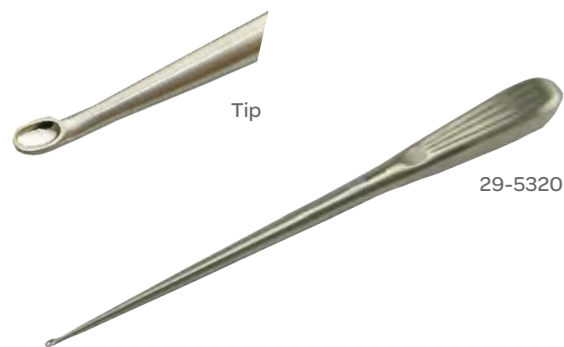

Caspar Curette

CODE	DESCRIPTION	TIP SIZE	LENGTH	
32-3410	Reverse	4 mm	9 3/4 in	248 mm
32-3411	Reverse	5 mm	9 3/4 in	248 mm



Cobb Curette

Handle Angled

CODE	DESCRIPTION	LENGTH	
29-8818A	Angled #000	11 in	279 mm
29-8819A	Angled #00	11 in	279 mm
29-8820A	Angled #0	11 in	279 mm
29-8821A	Angled #1	11 in	279 mm
29-8822A	Angled #2	11 in	279 mm
29-8823A	Angled #3	11 in	279 mm
29-8824A	Angled #4	11 in	279 mm
29-8825A	Angled #5	11 in	279 mm
29-8826A	Angled #6	11 in	279 mm

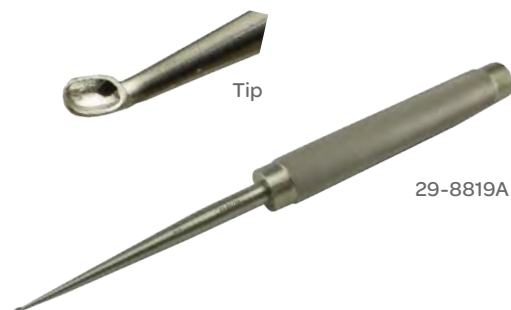

Curettes

Cobb Curette

CODE	DESCRIPTION	TIP SIZE	LENGTH
23-2570	#000	3.25 mm	11 in 279 mm
23-2571	#00	4 mm	11 in 279 mm
23-2572	#0	5 mm	11 in 279 mm
23-2573	#1	6 mm	11 in 279 mm
23-2574	#2	7.5 mm	11 in 279 mm
23-2575	#3	9 mm	11 in 279 mm
23-2576	#4	11.5 mm	11 in 279 mm
23-2577	#5	13 mm	11 in 279 mm
23-2578	#6	15.5 mm	11 in 279 mm

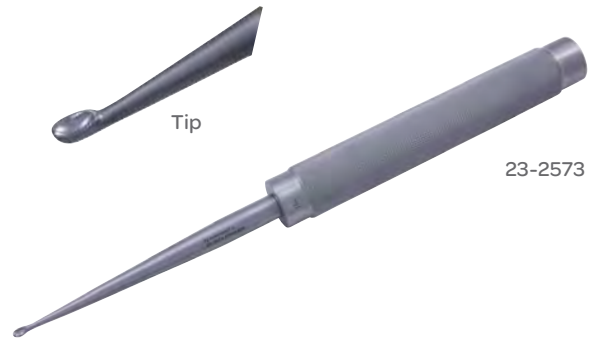

Cobb Curette

Straight

CODE	DESCRIPTION	LENGTH
57-4800	Size 0000	15 in 381 mm
57-4801	Size 000	15 in 381 mm
57-4802	Size 00	15 in 381 mm



Cobb Curette

Straight

CODE	DESCRIPTION	LENGTH
67-7107	2.5 x 4 mm	12½ in 318 mm
67-7104	2 x 3.3 mm	12½ in 318 mm
67-7105	2 x 3.3 mm	12½ in 318 mm
67-7111	3.5 x 6 mm	12½ in 318 mm
67-7109	3 x 5 mm	12½ in 318 mm
67-7113	4.5 x 7.5 mm	12½ in 318 mm
67-7115	5.5 x 9 mm	12½ in 318 mm
67-7117	7.5 x 11.5 mm	12½ in 318 mm
67-7119	8.5 x 13 mm	12½ in 318 mm
67-7121	10 x 15.5 mm	12½ in 318 mm
67-7108	2.5 x 4 mm	14 in 356 mm
67-7106	2 x 3.3 mm	14 in 356 mm
67-7112	3.5 x 6 mm	14 in 356 mm
67-7110	3 x 5 mm	14 in 356 mm
67-7114	4.5 x 7.5 mm	14 in 356 mm
67-7116	5.5 x 9 mm	14 in 356 mm
67-7118	7.5 x 11.5 mm	14 in 356 mm
67-7120	8.5 x 13 mm	14 in 356 mm
67-7122	10 x 15.5 mm	14 in 356 mm

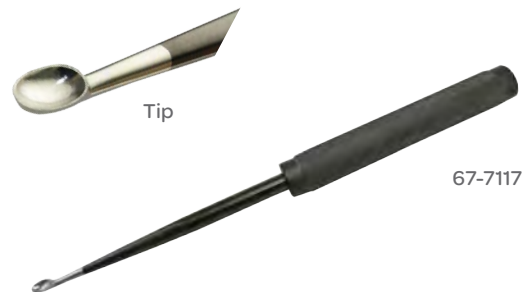

Curettes

Cobb Curette

Handle Angled

CODE	DESCRIPTION	LENGTH
29-8823	Straight #3	11 in 279 mm

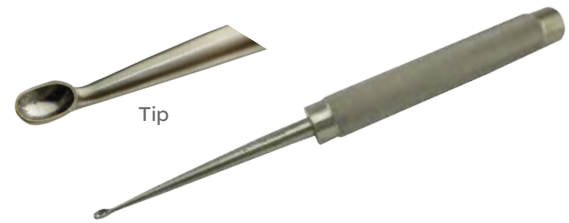

Epstein Curette

CODE	DESCRIPTION	LENGTH
57-4620	#000	8 in 203 mm
57-4621	#00	8 in 203 mm
57-4622	#0	8 in 203 mm
57-4625	#0	10 in 254 mm

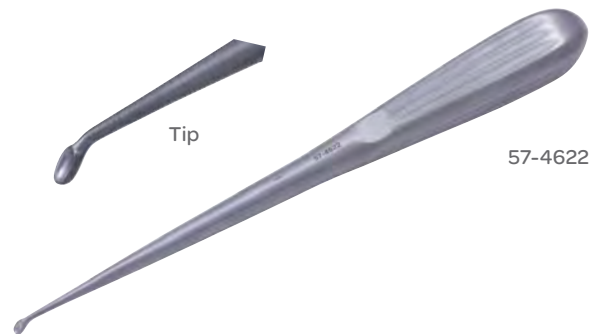

Hardy™ Bay Curette

Ring Angled Up

CODE	DESCRIPTION	LENGTH
67-7139	2 mm	9 ½ in 241 mm
67-7140	2 mm	11 in 280 mm
67-7142	3 mm	11 in 280 mm
67-7144	5 mm	11 in 280 mm
67-7141	2 mm	13 in 330 mm
67-7143	3 mm	13 in 330 mm
67-7145	5 mm	13 in 330 mm

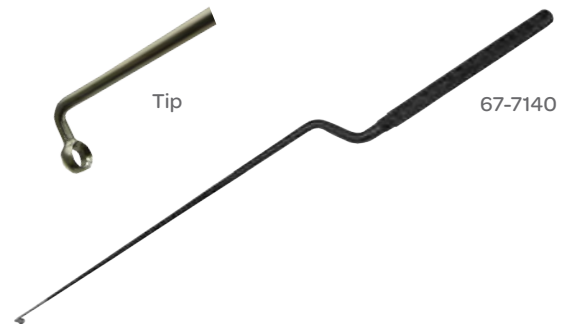

Hardy™ Bay Curette

Ring Angled Down

CODE	DESCRIPTION	LENGTH
67-7146	2 mm	9 ½ in 241 mm
67-7147	2 mm	11 in 280 mm
67-7149	3 mm	11 in 280 mm
67-7151	5 mm	11 in 280 mm
67-7148	2 mm	13 in 330 mm
67-7150	3 mm	13 in 330 mm
67-7152	5 mm	13 in 330 mm

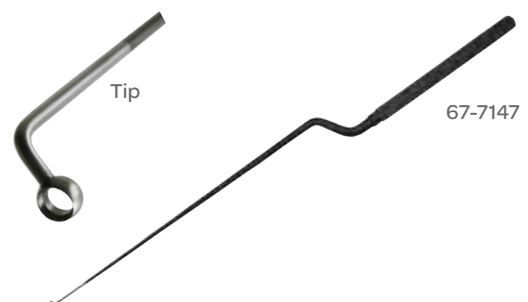

Curettes

Hardy™ Bay Curette

Ring Angled 90° Left

CODE	DESCRIPTION	LENGTH
67-7153	2 mm	9½ in 241 mm
67-7154	2 mm	11 in 280 mm
67-7156	3 mm	11 in 280 mm
67-7158	5 mm	11 in 280 mm
67-7155	2 mm	13 in 330 mm
67-7157	3 mm	13 in 330 mm
67-7159	5 mm	13 in 330 mm

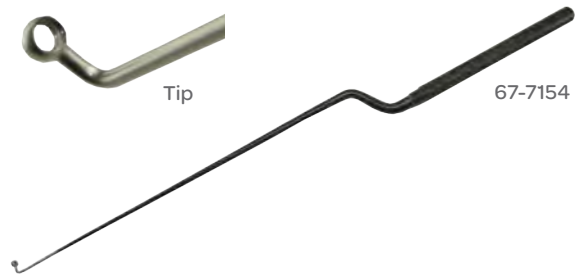

Hardy™ Bay Curette

Ring Angled 45° Right

CODE	DESCRIPTION	LENGTH
67-7160	2 mm	9½ in 241 mm
67-7161	2 mm	11 in 280 mm
67-7163	3 mm	11 in 280 mm
67-7165	5 mm	11 in 280 mm
67-7162	2 mm	13 in 330 mm
67-7164	3 mm	13 in 330 mm
67-7166	5 mm	13 in 330 mm

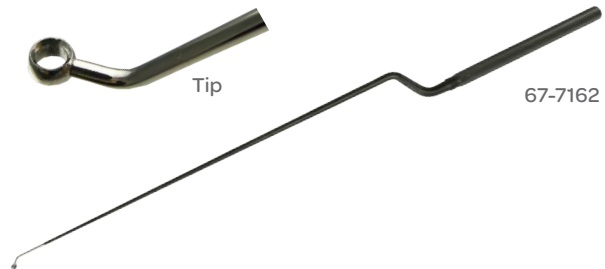

Hardy™ Bay Curette

Distal Tip Curved Right

CODE	DESCRIPTION	LENGTH
67-7167	5 mm	11 in 280 mm
67-7168	5 mm	13 in 330 mm

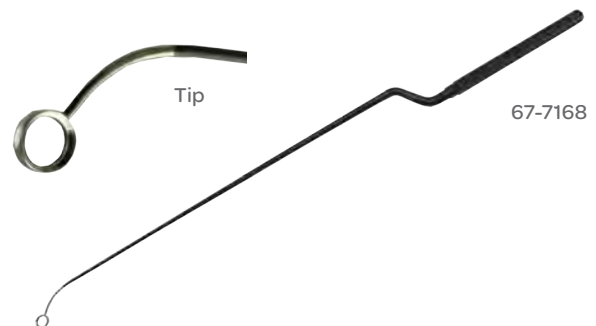

Hardy™ Bay Curette

Distal Tip Curved Left

CODE	DESCRIPTION	LENGTH
67-7169	5 mm	11 in 280 mm
67-7170	5 mm	13 in 330 mm

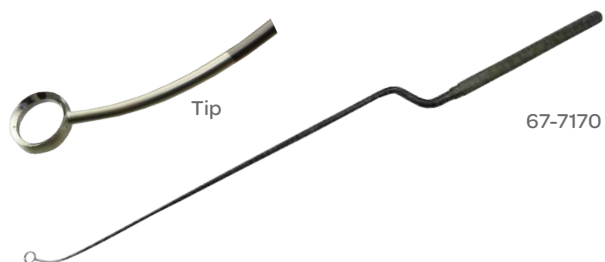

Curettes

Microsect® Curette

CODE	DESCRIPTION	SIZE	LENGTH	
47-5012	Backward Angle	#1	10 in	254 mm
47-5014	Backward Angle	#2	10 in	254 mm
47-5016	Backward Angle	#3	10 in	254 mm
47-5018	Backward Angle	#4	10 in	254 mm
47-5020	Backward Angle	#5	10 in	254 mm
47-5011	Forward Angle	#1	10 in	254 mm
47-5013	Forward Angle	#2	10 in	254 mm
47-5015	Forward Angle	#3	10 in	254 mm
47-5017	Forward Angle	#4	10 in	254 mm
47-5019	Forward Angle	#5	10 in	254 mm



Scoville Curette

CODE	DESCRIPTION	DESCRIPTION	LENGTH	
67-7171	Straight	4 x 10 mm	12 in	305 mm
67-7172	Straight	4 x 10 mm	14 in	356 mm
67-7173	Straight	6 x 10 mm	15 in	381 mm

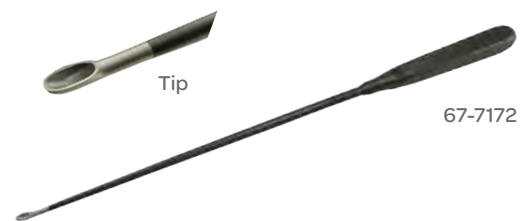

Scoville Curette

CODE	DESCRIPTION	CUP SIZE	LENGTH	
67-7174	Lateral	4 x 10 mm	12 in	305 mm
67-7175	Lateral	4 x 10 mm	14 in	356 mm
67-7176	Lateral	6 x 10 mm	15 in	381 mm
67-7177	Angular	4 x 10 mm	12 in	305 mm
67-7178	Angular	4 x 10 mm	14 in	356 mm
67-7179	Angular	6 x 10 mm	15 in	381 mm

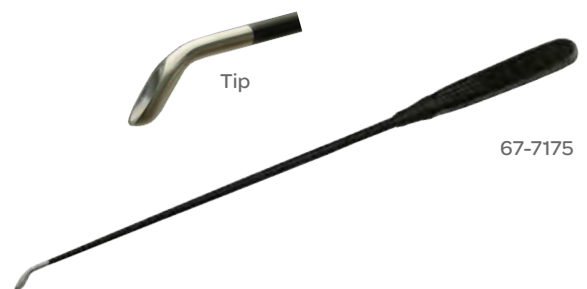

Scoville Curette

CODE	DESCRIPTION	CUP SIZE	LENGTH	
23-1000	Straight	4 x 10 mm	10 in	254 mm
23-1002	Angular	4 x 10 mm	10 in	254 mm
23-1001	Lateral	4 x 10 mm	10 in	254 mm



Curettes

Volkman Curette

Double-Ended

CODE	DESCRIPTION	LENGTH
29-8501	Round and Oval Cups	5 in 127 mm
29-8503	Round and Oval Cups	8 in 203 mm
29-8514	Round and Oval Cups	5½ in 140 mm
29-8502	Round and Oval Cups	6½ in 165 mm
29-8513	Round and Oval Cups	5 in 127 mm
29-8517	Round and Oval Cups	6¾ in 171 mm

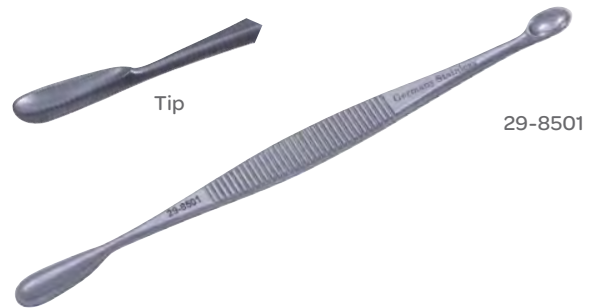

Cutters (Bone)

Karlin™ XL Bone Cutter

CODE	DESCRIPTION	WORKING DISTANCE	TOTAL LENGTH
46-2630	Forward Straight	4 ¼ in 104 mm	9 ½ in 240 mm
46-2640	Backward Straight	4 ¼ in 104 mm	9 ½ in 240 mm
46-2635	Forward Angle	4 ¼ in 104 mm	9 ½ in 240 mm



Dissectors

Annular Dissector Perforator

Tip Tapers ¼ in (6 mm) to ⅛ in (3 mm)

CODE	TIP LENGTH	LENGTH
46-3006	½ in 13 mm	8¾ in 222 mm

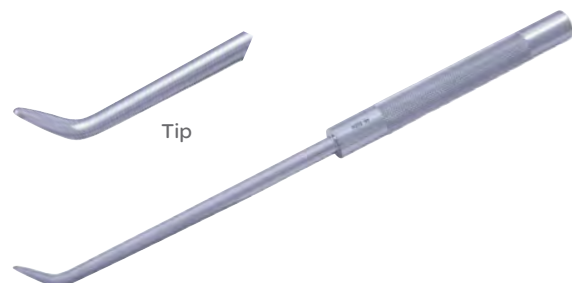

Dissectors (Vertebral)

Vertebral Body Dissector

Caspar Type

CODE	DESCRIPTION
57-5699	Small, Stainless Steel
57-5700	Large, Stainless Steel



57-5699

Dissector

Blunt

CODE	DESCRIPTION	LENGTH
67-7418	Double-Ended Packer	12 ½ in 317 mm
67-7419	Double-Ended Packer	13 ½ in 343 mm



67-7419

Dissector

CODE	DESCRIPTION	LENGTH
67-7410	Spoon	12 ½ in 318 mm
67-7411	Spoon	13 ½ in 343 mm



67-7410

Dissectors

Crockard™ Bayonet Micro-Dissector

CODE	DESCRIPTION	LENGTH
50-1665	For Transoral Dissection	10 in 254 mm



Dissectors

Microset Dissector

Straight Dissector

CODE	DESCRIPTION	LENGTH
47-5021	3 mm	10 in 254 mm
47-5022	5 mm	10 in 254 mm



Milligan Dissector

Double-Ended

CODE	TIP SIZE	LENGTH
65-1038	14 mm and 16 mm	8½ in 216 mm



Oldberg Dissector

CODE	DESCRIPTION	LENGTH
26-4809	Dissector	7 in 178 mm



Penfield Dissector

CODE	SIZE	DESCRIPTION	LENGTH
65-1015	1	Broad Curved Dissector, and Sharp Round Spoon, Double-Ended	7 in 178 mm
65-1016	2	Slightly Curved Dissector, and Wax Packer, Double-Ended	7¾ in 197 mm
65-1017	3	Full Curved Dissector and Wax Packer, Double-Ended	7¾ in 197 mm
65-1018	4	Slightly Curved Dissector, Light	8¼ in 210 mm
65-1019	5	Slightly Curved Blunt Dissector, Double-Ended	11½ in 272 mm

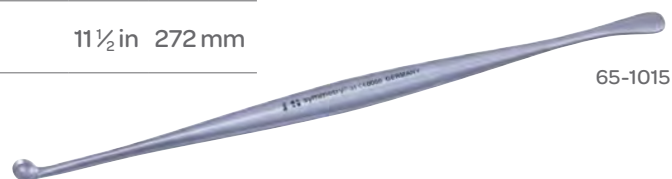

65-1015

Dissectors

Penfield Dissector

CODE	SIZE	DESCRIPTION	LENGTH
67-7410	1	Broad Curved Dissector, and Sharp Round Spoon, Double-Ended	12 ½ in 318 mm
67-7412	2	Slightly Curved Dissector, and Wax Packer, Double-Ended	12 ½ in 318 mm
67-7414	3	Full Curved Dissector and Wax Packer, Double-Ended	12 ½ in 318 mm
67-7416	4	Slightly Curved Dissector, Light	12 ½ in 318 mm
67-7418	5	Slightly Curved Blunt Dissector, Double-Ended	12 ½ in 318 mm
67-7411	1	Broad Curved Dissector, and Sharp Round Spoon, Double-Ended	13 ½ in 343 mm
67-7413	2	Slightly Curved Dissector, and Wax Packer, Double-Ended	13 ½ in 343 mm
67-7415	3	Full Curved Dissector and Wax Packer, Double-Ended	13 ½ in 343 mm
67-7417	4	Slightly Curved Dissector, Light	13 ½ in 343 mm
67-7419	5	Slightly Curved Blunt Dissector, Double-Ended	13 ½ in 343 mm

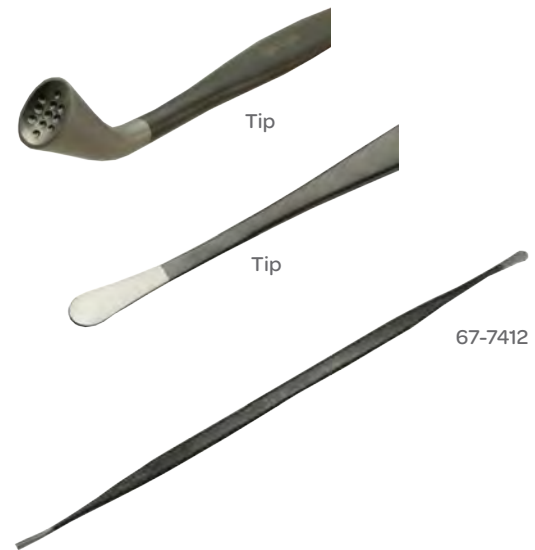

Penfield Dissector

CODE	DESCRIPTION	LENGTH
46-3139	Lumbar #1	9 ½ in 241 mm
46-3140	Lumbar #2	9 ½ in 241 mm
46-3142	Lumbar #4	9 ½ in 241 mm



Dissectors

Magnafree® Penfield Dissector

CODE	SIZE	DESCRIPTION	LENGTH
65-2402	1	Broad Curved Dissector, and Sharp Round Spoon, Double-Ended	7 in 178 mm
65-2403	2	Slightly Curved Dissector, and Wax Packer, Double-Ended	7¾ in 197 mm
65-2404	3	Fully Curved Dissector and Wax Packer, Double-Ended	7¾ in 197 mm
65-2405	4	Slightly Curved Dissector, Light Length	8¼ in 210 mm

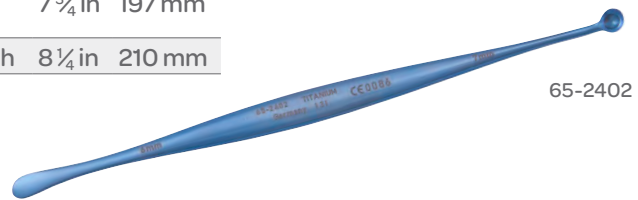

65-2402

Distractors (Cervical)

Caspar Cervical Vertebral Body Multi-Level Distractor

Stainless Steel

CODE	DESCRIPTION
57-5116	Left
57-5115	Right



57-5116

Cervical Distractor

Stainless Steel

CODE	TIP SIZE
57-5695	Left Drill Guide
57-5694	Right Drill Guide



57-5694

Distractors (Pin)

Caspar Distraction Pin

Stainless Steel

CODE	DESCRIPTION
57-5108	16 mm



Distractors

Caspar Distractor Only

Stainless Steel

CODE	DESCRIPTION
57-5101	Left
57-5105	Right



57-5101

Dowel Instruments

Guard Guide

Stainless Steel

CODE	DESCRIPTION	LENGTH
14-1043	Small $\frac{3}{8}$ in (9.5 mm)	7 $\frac{1}{2}$ in 191 mm
14-1044	Large $\frac{1}{2}$ in (13 mm)	7 $\frac{1}{2}$ in 191 mm



14-1043

Dowel Instruments

Dowel Cutter

Stainless Steel

CODE	DESCRIPTION
56-1005	12 mm
56-1006	14 mm
56-1007	16 mm
56-1008	18 mm



56-1005

Dowel Instruments

Dowel Cutter Shaft

CODE	DESCRIPTION	LENGTH
11-1019	Cutter Shaft	6½ in 165 mm



Dowel Instruments

Dowel Ejector

CODE	DESCRIPTION	LENGTH
80-1001	Ejector	4½ in 114 mm



Dowel Instruments

Crossbar Handle

CODE	DESCRIPTION
11-1002	Two each



Dowel Instruments

Dowel Pin

Center Pins

CODE	DESCRIPTION
47-1010	12 mm
47-1011	14 mm
47-1012	16 mm
47-1013	18 mm



47-1010

47-1012

47-1013

Drills (ACF)

Ultra™ ACF Side Loading Twist Drill

CODE
59-0112



Tip

Ultra™ ACF Twist Drill

CODE
59-0109

Drills (Cervical)

Cervical Drill Tip

CODE	DESCRIPTION
26-1265	10 mm
26-1266	12 mm
26-1267	14 mm
26-1268	16 mm



26-1265

Drills (Guard Cap)

Drill Guard Cap

CODE	DIAMETER	LENGTH
12-1007	1 in 25 mm	1¼ in 32 mm



Drills (Shaft)

Drill Shaft

CODE	DESCRIPTION	LENGTH
28-1001	Small (13 mm)	5 ⁹ / ₁₆ in 141 mm
28-1002	Large (16 mm)	5 ⁹ / ₁₆ in 141 mm



28-1001

Drills (Twist)

Caspar Twist Drill Bit

CODE	LENGTH
57-5111	5¾ in 145 mm



Drivers (Anterior Cervical)

Anterior Cervical Graft Driver

CODE	DESCRIPTION	TIP THICKNESS		LENGTH	
46-3026	Guarded	1/4 in	6.5 mm	8 3/4 in	222 mm
46-3028	Unguarded	5/16 in	7 mm	8 3/4 in	222 mm



Drivers (Lumbar)

Lumbar Graft Driver

CODE	DESCRIPTION	TIP THICKNESS		LENGTH	
46-3027	Unguarded	3/8 in	10 mm	8 3/4 in	222 mm



Drivers (Screw Driver)

Caspar Screw Driver

CODE	DESCRIPTION	LENGTH	
57-5109	Screw Driver	8 in	203 mm



Elevators

Adson Periosteal Elevator

CODE	DESCRIPTION	BLADE WIDTH	LENGTH
65-1033	No. 4, Straight, Semi-Sharp Edge	$\frac{5}{16}$ in 8 mm	$6\frac{1}{2}$ in 165 mm
65-1030	No. 1, Chisel Edge	$\frac{5}{16}$ in 8 mm	$6\frac{1}{2}$ in 165 mm
65-1031	No. 2, Curved, Blunt Edge	$\frac{1}{4}$ in 6 mm	$6\frac{1}{2}$ in 165 mm
65-1032	No. 3, Curved, Semi-Sharp Edge	$\frac{1}{4}$ in 6 mm	$6\frac{1}{2}$ in 165 mm

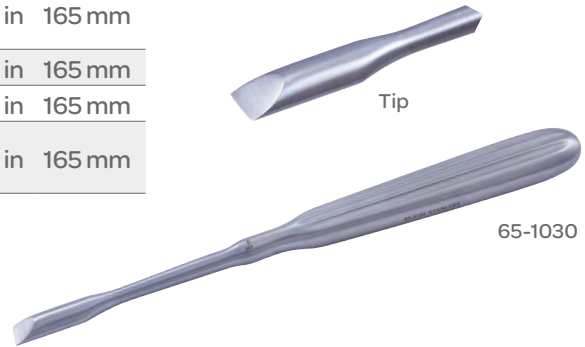

Carroll Periosteal Elevator

CODE	DESCRIPTION	BLADE WIDTH	LENGTH
65-2549	Double-Ended	$\frac{1}{8}$ in 3 mm $\frac{3}{8}$ in 10 mm	$5\frac{1}{2}$ in 140 mm



Chandler Elevator

CODE	DESCRIPTION	TIP SIZE	LENGTH
26-5621	Blunt	8 x 13 mm	$7\frac{1}{2}$ in 191 mm
26-5622	Blunt	12 x 19 mm	8 in 203 mm
26-5623	Blunt	17 x 25 mm	9 in 229 mm
26-5624	Blunt	19 x 30 mm	10 in 254 mm



Cloward Periosteal Elevator

CODE	DESCRIPTION	TIP WIDTH	LENGTH
26-2777	#4	12 mm	$7\frac{3}{4}$ in 197 mm



Elevators

Cobb Elevator

Sharp Rounded Edge

CODE	DESCRIPTION	LENGTH
67-7028	$\frac{3}{8}$ in 10 mm	12 in 305 mm
67-7030	$\frac{1}{2}$ in 13 mm	12 in 305 mm
67-7032	$\frac{3}{4}$ in 19 mm	12 in 305 mm
67-7029	$\frac{3}{8}$ in 10 mm	13 in 330 mm
67-7031	$\frac{1}{2}$ in 13 mm	13 in 330 mm
67-7033	$\frac{3}{4}$ in 19 mm	13 in 330 mm



67-7028

Cobb Elevator

CODE	WIDTH	LENGTH
26-5023	$\frac{1}{2}$ in 13 mm	14 in 356 mm
26-5020	$\frac{5}{8}$ in 15 mm	14 in 356 mm
26-5021	$\frac{3}{4}$ in 19 mm	14 in 356 mm
26-5022	1 in 25 mm	14 in 356 mm



26-5021

Cobb Spinal Elevator

CODE	BLADE WIDTH	LENGTH
26-4910	$\frac{3}{8}$ in 9.5 mm	11 in 279 mm
26-4913	$\frac{1}{2}$ in 12.7 mm	11 in 279 mm
26-4919	$\frac{3}{4}$ in 19 mm	11 in 279 mm
26-4925	1 in 25 mm	11 in 279 mm
26-4930	$1\frac{1}{4}$ in 31 mm	11 in 279 mm
26-4949	$1\frac{3}{4}$ in 44 mm	11 in 279 mm



26-4925

Cobb Spinal Elevator

Hexagonal Handle

CODE	WIDTH	LENGTH
26-5001	$\frac{3}{8}$ in 9.5 mm	$9\frac{1}{2}$ in 241 mm
26-5002	$\frac{1}{2}$ in 12.7 mm	$9\frac{1}{2}$ in 241 mm
26-5003	$\frac{3}{4}$ in 19 mm	$9\frac{1}{2}$ in 241 mm
26-5004	1 in 25 mm	$9\frac{1}{2}$ in 241 mm
26-5005	$1\frac{1}{4}$ in 31 mm	$9\frac{1}{2}$ in 241 mm



26-5003

Elevators

Cobb Spinal Elevator

CODE	BLADE WIDTH		LENGTH	
65-2545	$\frac{3}{8}$ in	10 mm	11 in	279 mm
65-2546	$\frac{1}{2}$ in	13 mm	11 in	279 mm
65-2547	$\frac{3}{4}$ in	19 mm	11 in	279 mm



65-2545

Cottle Elevator

CODE	DESCRIPTION	LENGTH
26-2766	Double-Ended	$8\frac{1}{8}$ in 225 mm



Cottle-McKenty Elevator

CODE	LENGTH
26-4226	$8\frac{1}{2}$ in 216 mm



Crego Elevator

Blunt

CODE	DESCRIPTION	TIP WIDTH	LENGTH
26-5500	Full Curve	15 mm	$7\frac{1}{2}$ in 191 mm
26-5503	Slight Curve	7 mm	8 in 203 mm



26-5503

Elevators

Cushing "Little Joker" Periosteal Elevator

Blunt

CODE	DESCRIPTION	LENGTH
26-6201	Round Edge	7 1/8 in 181 mm
26-6203	"Little Joker"	7 1/2 in 191 mm

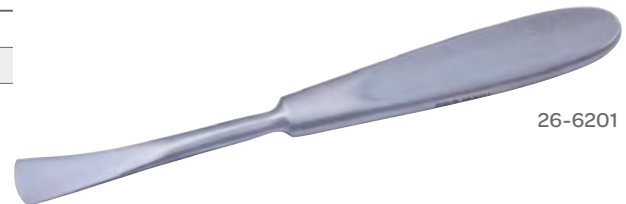

26-6201

Cushing "Little Joker" Periosteal Elevator

CODE	DESCRIPTION	BLADE WIDTH	LENGTH
65-1047	Hollow Handle	1/4 in 6 mm	6 in 152 mm
65-1048	Solid Handle	1/4 in 6 mm	7 1/2 in 191 mm
65-1050	Narrow, Sharp	1/4 in 6 mm	8 1/8 in 206 mm
65-1075	Rounded Edge, Sharp, Wide	5/8 in 16 mm	7 1/4 in 185 mm
65-1076	Square Edge, Sharp, Wide	5/8 in 16 mm	7 1/4 in 185 mm



65-1047

Cushing "Little Joker" Periosteal Elevator

CODE	DESCRIPTION	BLADE WIDTH	LENGTH
67-7034	Sharp Rounded Edge	5/8 in 16 mm	9 1/2 in 241 mm
67-7035	Sharp Rounded Edge	5/8 in 16 mm	10 1/2 in 266 mm
67-7036	Sharp Square Edge	5/8 in 16 mm	9 1/2 in 241 mm
67-7037	Sharp Square Edge	5/8 in 16 mm	10 1/2 in 266 mm



67-7034

Hoen Periosteal Elevator

CODE	DESCRIPTION	BLADE WIDTH	LENGTH
65-1001	No.1	5/16 in 8 mm	7 in 178 mm
65-1002	No.2	5/8 in 15 mm	7 1/4 in 185 mm
65-1003	No.3	3/4 in 20 mm	7 1/2 in 191 mm



65-1002

Elevators

Iowa University Periosteal Elevator

CODE	BLADE WIDTH	LENGTH
65-1080	1 $\frac{1}{16}$ in 17 mm	7 $\frac{1}{4}$ in 185 mm



65-1080

Joseph Periosteal Elevator

CODE	DESCRIPTION	LENGTH
26-4404	Light Curve, Sharp	6 $\frac{1}{2}$ in 165 mm



Karlin™ XL Magnum Cobb Elevator

CODE	WIDTH	LENGTH
46-3242	15 mm	13 $\frac{1}{4}$ in 337 mm
46-3243	20 mm	13 $\frac{1}{4}$ in 337 mm
46-3244	25 mm	13 $\frac{1}{4}$ in 337 mm
46-3245	30 mm	13 $\frac{1}{4}$ in 337 mm
46-3246	35 mm	13 $\frac{1}{4}$ in 337 mm



46-3242

Key Periosteal Elevator

CODE	DESCRIPTION	WIDTH	LENGTH
26-5604	Slight Curve	$\frac{1}{8}$ in	7 $\frac{1}{2}$ in 191 mm
26-5606	Slight Curve	$\frac{1}{4}$ in	7 $\frac{1}{2}$ in 191 mm
26-5612	Slight Curve	$\frac{1}{2}$ in	7 $\frac{1}{2}$ in 191 mm
26-5620	Slight Curve	$\frac{3}{4}$ in	7 $\frac{1}{2}$ in 191 mm
26-5625	Slight Curve	1 in	7 $\frac{1}{2}$ in 191 mm



26-5606

Elevators

Key Periosteal Elevator

CODE	DESCRIPTION	BLADE WIDTH	LENGTH
65-2510	Elevator	$\frac{1}{4}$ in 6 mm	$7\frac{1}{2}$ in 191 mm
65-2511	Elevator	$\frac{3}{8}$ in 10 mm	$7\frac{1}{2}$ in 191 mm
65-2512	Elevator	$\frac{1}{2}$ in 13 mm	$7\frac{1}{2}$ in 191 mm
65-2513	Elevator	$\frac{3}{4}$ in 19 mm	$7\frac{1}{2}$ in 191 mm

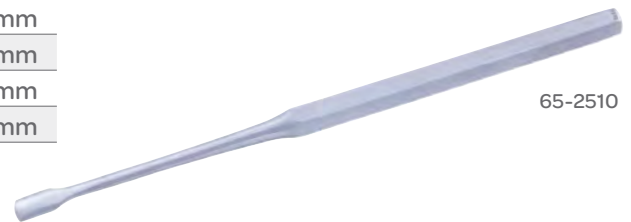

65-2510

Klein-Kutz Elevator and Dissector

CODE	DESCRIPTION	LENGTH
20-1788	Double-Ended, 2 mm and 3 mm Tips, Sharp	$7\frac{1}{2}$ in 191 mm

Lane Elevator

CODE	DESCRIPTION	BLADE WIDTH	LENGTH
26-1411	Blunt	6 mm	$6\frac{3}{4}$ in 171 mm
26-1412	Blunt	10 mm	$6\frac{3}{4}$ in 171 mm



26-1411

Langenbeck Periosteal Elevator

CODE	DESCRIPTION	BLADE WIDTH	LENGTH
65-1115	Narrow	$\frac{1}{4}$ in 6 mm	$8\frac{1}{4}$ in 210 mm
65-1116	Wide	$\frac{1}{16}$ in 17 mm	$7\frac{1}{2}$ in 191 mm



65-1116

Elevators



46-3425

Magnum Cobb Elevator Set

Set of Six Cobb Elevators, Straight

CODE	DESCRIPTION	WORKING DISTANCE		HANDLE DIAMETER		HANDLE LENGTH		LENGTH	
46-3425	Set includes:								
46-3426	10 m	4 ⁷ / ₁₀ in	119 mm	1 ³ / ₂₅ in	28 mm	7 ⁴ / ₅ in	198 mm	12 ³ / ₅ in	320 mm
46-3427	15 m	4 ⁷ / ₁₀ in	119 mm	1 ³ / ₂₅ in	28 mm	7 ⁴ / ₅ in	198 mm	12 ³ / ₅ in	320 mm
46-3428	20 m	4 ⁷ / ₁₀ in	119 mm	1 ³ / ₂₅ in	28 mm	7 ⁴ / ₅ in	198 mm	12 ³ / ₅ in	320 mm
46-3429	25 m	4 ⁷ / ₁₀ in	119 mm	1 ³ / ₂₅ in	28 mm	7 ⁴ / ₅ in	198 mm	12 ³ / ₅ in	320 mm
46-3430	30 m	4 ⁷ / ₁₀ in	119 mm	1 ³ / ₂₅ in	28 mm	7 ⁴ / ₅ in	198 mm	12 ³ / ₅ in	320 mm
46-3431	35 m	4 ⁷ / ₁₀ in	119 mm	1 ³ / ₂₅ in	28 mm	7 ⁴ / ₅ in	198 mm	12 ³ / ₅ in	320 mm

Elevators

McCulloch-Cobb Elevator

Semi-Sharp Blade

CODE	DEPTH	LENGTH
57-5613	13 mm	10 ½ in 267 mm
57-5619	19 mm	10 ½ in 267 mm



57-5613

McCulloch Nerve Root Elevator

Blunt, Double-Ended

CODE	BLADE WIDTH	LENGTH
57-5763	5.6 mm Both Ends	9 in 229 mm



McKenty Periosteal Elevator

CODE	DESCRIPTION	LENGTH
26-4224	Light Curve, Sharp, 4 mm	6 in 152 mm
26-4225	Light Curve, Sharp, 5 mm	6 in 152 mm



26-4224

Molt Periosteal Elevator

CODE	DESCRIPTION	LENGTH
32-3420	#9	7 ¼ in 185 mm
26-3700	#9	7 ¼ in 185 mm

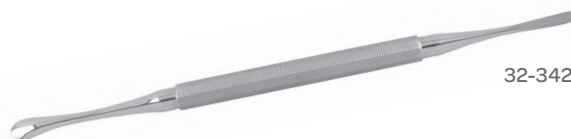

32-3420

Elevators

Periosteal Elevator

Phenolic Handle

CODE	DESCRIPTION	TIP WIDTH	LENGTH
26-4450	Straight	3 mm	7¼ in 184 mm
26-4452	Straight	6 mm	7¼ in 184 mm
26-4458	Straight	20 mm	7¼ in 184 mm
26-4454	Straight	14 mm	7¾ in 197 mm
26-4457	Curved	13 mm	7¼ in 184 mm
26-4455	Curved	14 mm	7¾ in 197 mm
26-4453	Sharp, Round Edge	6 mm	7¼ in 184 mm



Periosteal Elevator

Sharp

CODE	DESCRIPTION	TIP WIDTH	LENGTH
65-1056	No. 1	⅜ in 5 mm	8 in 203 mm
65-1057	No. 2	¼ in 6.4 mm	8 in 203 mm
65-1058	No. 3	⅝ in 8 mm	8 in 203 mm
65-1059		1⅝ in 12 mm	8 in 203 mm



Osteophyte Periosteal Elevator

CODE	DESCRIPTION	LENGTH
57-5038	Elevator	8 in 203 mm
65-1064	Elevator	8 in 203 mm



Elevators

Sayre Periosteal Elevator

CODE	DESCRIPTION	LENGTH
26-3750	Sharp	6 ½ in 165 mm
26-3751	Blunt	6 ½ in 165 mm



26-3751

Sedillot Periosteal Elevator

CODE	DESCRIPTION	TIP WIDTH	LENGTH
26-4738	Sharp	18 mm	7 ½ in 191 mm



Sharp Periosteal Elevator

CODE	DESCRIPTION	LENGTH
65-1121	⅜ in	8 in 203 mm



Elevators

Woodson Elevator

Spatula

CODE	DESCRIPTION	LENGTH
57-3515	Double-Ended	7 $\frac{1}{8}$ in 181 mm
67-7039	Double-Ended	12 in 305 mm



57-3515

Woodson Elevator-Spatula

Double-Ended

CODE	DESCRIPTION	BLADE (W X D)	LENGTH
59-1000	Semi-Sharp	$\frac{1}{8}$ x $\frac{1}{2}$ in 3 x 13 mm	10 in 254 mm

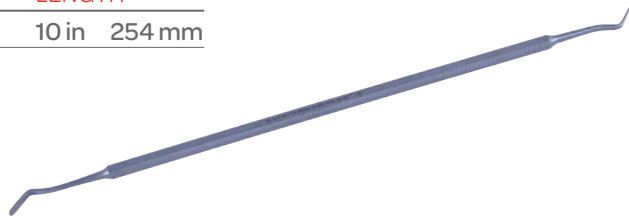

Files

Bone File

Double-Ended

CODE	DESCRIPTION	LENGTH
26-1350	5 mm and 7 mm	7 $\frac{1}{4}$ in 184 mm
26-1428	2-Sided Convex and Flat, Single-Ended, Tapers from 6 - 23 mm	11 in 279 mm
26-1450	Single-Ended, 15 mm wide	9 $\frac{1}{2}$ in 241 mm

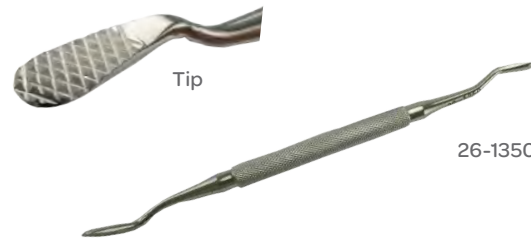

26-1350

Forceps (ACF)

Ultra™ ACF Bone Graft Harvesting Forceps

CODE	DESCRIPTION
59-0124	7 mm

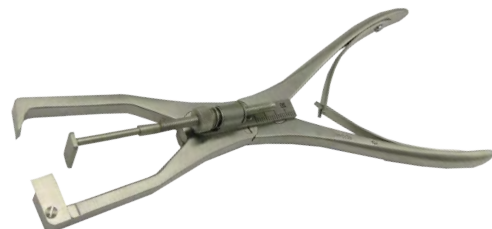

Forceps (Bone Cutting)

Horsley Bone Cutting Forceps

Double Action

CODE	DESCRIPTION	LENGTH
30-1298	Curved Shaft, Angular Jaw	10 ½ in 267 mm

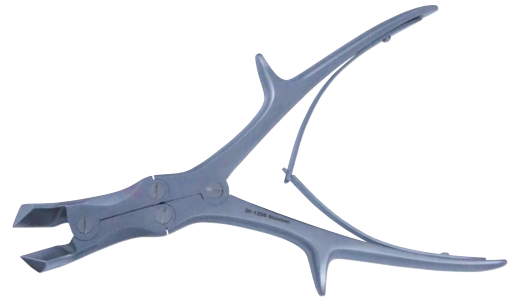

Liston Bone Cutting Forceps

CODE	DESCRIPTION	LENGTH
30-1310	Straight	5 ½ in 140 mm



Ruskin Bone Cutting Forceps

CODE	DESCRIPTION	LENGTH
30-1290	Double-Action	7 ¼ in 185 mm



Forceps (Bone Cutting)

Stille-Liston Bone Forceps

Double Action

CODE	DESCRIPTION	LENGTH
30-1295	Straight	10 ½ in 267 mm
30-1296	Curved	10 ½ in 267 mm



30-1295

Forceps (Bone Rongeur)

Stille-Luer Bone Rongeur

CODE	DESCRIPTION	LENGTH
31-3023	Double-Action, Jaws 10 mm Wide, Straight	9 in 229 mm



Forceps (Dressing)

Cushing Dressing Forceps

CODE	DESCRIPTION	TIP WIDTH	LENGTH
30-1203	Serrated, Bayonet	2.1 mm	3 ¼ in 140 mm



Forceps (Dressing)

Williams Microlumbar Forceps

CODE	DESCRIPTION	LENGTH
80-1654	Single Tooth Cup, 2 mm Bite Size	5½ in 140 mm



Forceps (Ligament)

Crockard™ Ligament Grasping Forceps

CODE	LENGTH
50-1663	10 in 254 mm



Forceps (Ligamentum Flavum)

Ligamentum Flavum Forceps

CODE	DESCRIPTION	LENGTH
30-1228	Curved on Side, 1x2 Teeth	7¼ in 184 mm



Forceps (Odontoid Peg)

Crockard™ Odontoid Peg Grasping Forceps

CODE	LENGTH
50-1662	9 in 229 mm



Gauges (ACF)

Ultra™ ACF Color Coded Depth Gauge

CODE	DESCRIPTION	LENGTH
59-0106	Cervical Spine Depth Gauge	



Gauges (Cervical Spanner)

Karlin™ Cervical Spanner

Cervical Spanner Set of six (6) with case. Designed to directly measure the height of the interspace, access soft tissue tension and distract the interspace.

CODE	DESCRIPTION	SPANNER WIDTH
46-3040	Set Includes:	
46-3041	Cervical Spanner	5 mm
46-3042	Cervical Spanner	6 mm
46-3043	Cervical Spanner	7 mm
46-3044	Cervical Spanner	8 mm
46-3045	Cervical Spanner	9 mm
46-3046	Cervical Spanner	10 mm
46-3047	Cervical Spanner Case	



46-3040

Gauges (Depth)

Depth Gauge

CODE	LENGTH
39-1012	8 ³ / ₈ in 213 mm



Gauges (Spinal)

LW Gauge

CODE	DESCRIPTION
39-1015	Designed to be used anywhere on the Spine to measure the length and width of a space.



Gouges

Alexander Gouge

CODE	TIP WIDTH	LENGTH
28-2804	4 mm	7 in 178 mm
28-2806	6 mm	7 in 178 mm
28-2808	8 mm	7 in 178 mm
28-2814	14 mm	7 in 178 mm

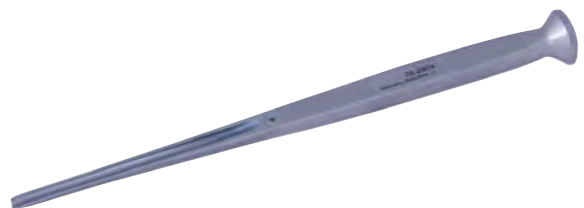

Gouges

Bishop Gouge

CODE	TIP WIDTH	LENGTH	
27-6063	3 mm	6 in	381 mm



Bone Gouge

CODE	DESCRIPTION	TIP WIDTH		LENGTH	
32-2010	Curved	¼ in	6 mm	11 in	279 mm
32-2011	Curved	⅜ in	10 mm	11 in	279 mm
32-2012	Curved	½ in	13 mm	11 in	279 mm
32-2013	Curved	⅝ in	16 mm	11 in	279 mm
32-2014	Curved	¾ in	19 mm	11 in	279 mm
32-2015	Curved	1 in	25 mm	11 in	279 mm
32-2016	Curved	1¼ in	32 mm	11 in	279 mm



32-2012

Bone Gouge

CODE	DESCRIPTION	TIP WIDTH		LENGTH	
32-2000	Straight	¼ in	6 mm	11 in	279 mm
32-2001	Straight	⅜ in	10 mm	11 in	279 mm
32-2002	Straight	½ in	13 mm	11 in	279 mm
32-2003	Straight	⅝ in	16 mm	11 in	279 mm
32-2004	Straight	¾ in	19 mm	11 in	279 mm
32-2005	Straight	1 in	25 mm	11 in	279 mm
32-2006	Straight	1¼ in	32 mm	11 in	279 mm



32-2001

Cobb Spinal Gouge

CODE	DESCRIPTION	TIP WIDTH		LENGTH	
32-2660	Straight	¼ in	6 mm	11 in	279 mm
32-2661	Lesser Curve	¼ in	6 mm	11 in	279 mm
32-2662	Full Curve	¼ in	6 mm	11 in	279 mm
32-2663	Reverse Curve	¼ in	6 mm	11 in	279 mm

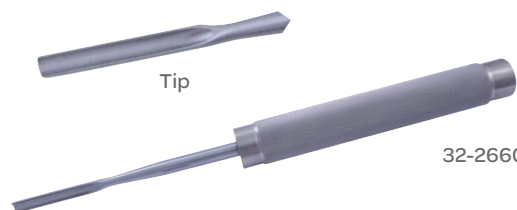

32-2660

Gouges

Cobb Spinal Gouge

CODE	DESCRIPTION	LENGTH	
28-8011	Straight	11 in	279 mm
28-8012	Medium Curve	11 in	279 mm
28-8013	Strong Curve	11 in	279 mm
28-8014	Reverse Curve	11 in	279 mm



28-8013

Hibbs Gouge

CODE	DESCRIPTION	TIP WIDTH		LENGTH	
28-5256	Curved	¼ in	6 mm	9 ½ in	241 mm
28-5260	Curved	⅜ in	10 mm	9 ½ in	241 mm
28-5262	Curved	½ in	12 mm	9 ½ in	241 mm
28-5266	Curved	⅝ in	16 mm	9 ½ in	241 mm
28-5270	Curved	¾ in	20 mm	9 ½ in	241 mm
28-5275	Curved	1 in	25 mm	9 ½ in	241 mm
28-5280	Curved	1 ⅛ in	30 mm	9 ½ in	241 mm
28-5290	Curved	1 ½ in	38 mm	9 ½ in	241 mm



28-5260

Hibbs Gouge

CODE	DESCRIPTION	TIP WIDTH		LENGTH	
28-5206	Straight	¼ in	6 mm	9 ½ in	241 mm
28-5210	Straight	⅜ in	10 mm	9 ½ in	241 mm
28-5212	Straight	½ in	12 mm	9 ½ in	241 mm
28-5216	Straight	⅝ in	16 mm	9 ½ in	241 mm
28-5220	Straight	¾ in	20 mm	9 ½ in	241 mm
28-5225	Straight	1 in	25 mm	9 ½ in	241 mm
28-5240	Straight	1 ½ in	38 mm	9 ½ in	241 mm



28-5210

Smith-Peterson Bone Gouge

CODE	DESCRIPTION	TIP WIDTH		LENGTH	
32-2550	Curved	¼ in	6 mm	8 in	203 mm
32-2551	Curved	⅜ in	10 mm	8 in	203 mm
32-2552	Curved	½ in	13 mm	8 in	203 mm
32-2553	Curved	⅝ in	16 mm	8 in	203 mm
32-2554	Curved	¾ in	19 mm	8 in	203 mm
32-2555	Curved	1 in	25 mm	8 in	203 mm
32-2556	Curved	1 ¼ in	32 mm	8 in	203 mm



32-2551

Gouges

Smith-Peterson Bone Gouge

CODE	DESCRIPTION	TIP WIDTH	LENGTH
32-2540	Straight	¼ in 6 mm	8 in 203 mm
32-2541	Straight	⅜ in 10 mm	8 in 203 mm
32-2542	Straight	½ in 13 mm	8 in 203 mm
32-2543	Straight	⅝ in 16 mm	8 in 203 mm
32-2544	Straight	¾ in 19 mm	8 in 203 mm
32-2545	Straight	1 in 25 mm	8 in 203 mm
32-2546	Straight	1¼ in 32 mm	8 in 203 mm

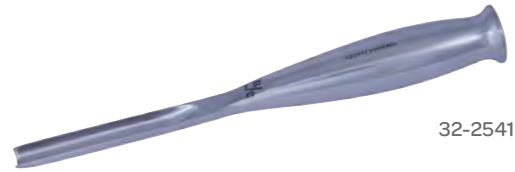

32-2541

Stille Gouge

CODE	DESCRIPTION	TIP WIDTH	LENGTH
28-4512	Straight	12 mm	8 in 203 mm
28-4515	Straight	15 mm	8 in 203 mm
28-4525	Straight	25 mm	8 in 203 mm



28-4512

Swan Neck Gouge

CODE	LENGTH
28-6255	9 in 229 mm



HOLDERS (Bone Graft)

Ultra™ Bone Graft Holder

CODE
59-0131



Hooks

Scoville Hook

CODE	DESCRIPTION	LENGTH	
13-1004C	Laminectomy Hook	2 in	51 mm
13-1005C	Laminectomy Hook	3 in	76 mm



13-1005C

Hooks (Adson)

Adson Dissecting Hook

CODE	DESCRIPTION	HOOK DIAMETER	LENGTH	
67-7428	Sharp	5 mm	10 in	254 mm
67-7429	Blunt	5 mm	10 in	254 mm



Tip



67-7429

Hooks (Bone)

Bone Hook

CODE	DESCRIPTION	HOOK DIAMETER	LENGTH	
32-3422	Sharp, Large	60 mm	8 ½ in	216 mm
32-3423	Sharp, Heavy Duty	19 mm	9 in	229 mm
32-3425	Sharp, Heavy Duty	30 mm	9 in	229 mm
32-3424	Blunt, Heavy Duty	19 mm	9 in	229 mm



32-3422

Hooks (Dural)

Dural Hook

CODE	TIP DIAMETER	LENGTH
38-1038	2 mm	6 ½ in 165 mm



Hooks (Ganglion)

Cushing Gasserian Ganglion Hook

CODE	DESCRIPTION	HOOK DEPTH	LENGTH
38-1030	Blunt	$\frac{3}{16}$ in 5 mm	9 in 229 mm
67-7430	Blunt	$\frac{3}{16}$ in 5 mm	11 in 280 mm



Hooks (Nerve)

Dandy Nerve Hook

CODE	DESCRIPTION	TIP LENGTH	LENGTH
67-7431	Straight, Blunt	3 mm	10 in 254 mm



Hoehn Nerve Hook

CODE	DESCRIPTION	TIP LENGTH	LENGTH
67-7432	Straight	$\frac{1}{4}$ in 7 mm	10 in 254 mm



Hook

Titanium

CODE	DESCRIPTION	TIP LENGTH	LENGTH
67-7433	Ball Tip	3 mm	10 in 254 mm
67-7434	Blunt Tip	2 mm	10 in 254 mm
67-7435	Blunt Tip	3 mm	10 in 254 mm



Lumbar Nerve Hook

CODE	LENGTH
46-3141	9½ in 241 mm



Hooks (Nerve)

Rhoton® Nerve Hook

Titanium

CODE	DESCRIPTION	TIP LENGTH	LENGTH
67-7437	#10 Blunt, 90°	1 mm	10 in 254 mm
67-7436	#9 Semi Sharp, 90°	1 mm	10 in 254 mm
67-7438	#11 Semi-Sharp, 40°	3 mm	10 in 254 mm

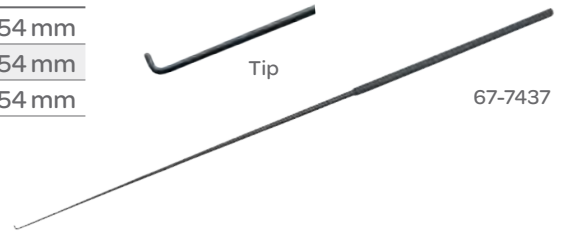

XL Cervical Micro Nerve Hook

CODE	WORKING DISTANCE	TOTAL LENGTH
46-2647	4 1/10 in 104 mm	9 1/2 in 240 mm

XL Cervical Micro Nerve Hook

CODE	WORKING DISTANCE	TOTAL LENGTH
46-2646	4 1/10 in 104 mm	9 1/2 in 240 mm



Impactors

Graft Impactor

Double-Ended

CODE	END DIAMETER	LENGTH
28-1000	7/16 in 11 mm	8 3/4 in 222 mm
	9/16 in 14 mm	

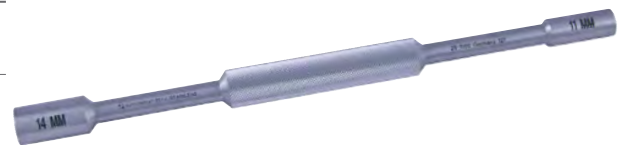

Offset Central Impactor

CODE
46-3007



Impactors (Bone Graft)

Bone Graft Impactor and Holder

CODE	LENGTH
28-1003	8 ³ / ₄ in 222 mm

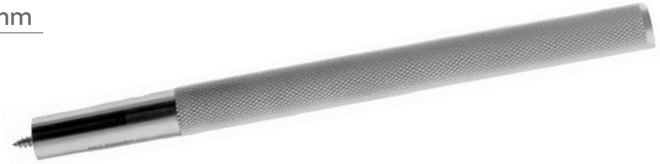

Impactors (Central Canal)



Central Canal Impactor

Used to impact symptomatic spondylophytes, placed beneath and clear of neurostructures. Slip resistant, textured impaction surface is held perpendicular to surrounding bone planes and impacted with a mallet.

CODE	DESCRIPTION	TIP WIDTH	TIP LENGTH	LENGTH
46-3008	Tip oriented 30° from vertical	⁷ / ₃₂ in 7 mm	¹ / ₂ in 13 mm	8 ³ / ₄ in 222 mm

Micro Offset Central Canal Impactor

CODE	TIP WIDTH	LENGTH
46-3021	4 mm	7 in 178 mm



Impactors (Lateral Gutter)

Lateral Gutter Impactor

CODE	TIP WIDTH	TIP DEPTH	LENGTH	
46-3009	13 mm	5 mm	7 in	178 mm



Impactors (Lumbar and Cervical)

Lumbar and Cervical Impactor/Graft Driver

CODE	DESCRIPTION	HEAD	LENGTH	
57-5248	Micro Lateral	4.8 x 10 mm	8 ½ in	216 mm
57-5243	Wide	10 x 13 mm	8 ½ in	216 mm
57-5244	Offset	6.5 x 11.5 mm	8 ½ in	216 mm
57-5246	Narrow	6 x 12.5 mm	8 ½ in	216 mm



57-5246

Kits (Anterior Fusion)



Anterior Fusion Kit

For Removal of Ruptured Cervical Disc Lesions and Osteophytes by an Anterior Surgical Approach

CODE	DESCRIPTION	DIAMETER	QUANTITY
80-1004	Kit with Case Includes (Below):		
21-1001	Instrument Case		
11-1002	Cross Bar Handle		2
56-1005	Dowel Cutter	12 mm	
56-1006	Dowel Cutter	14 mm	
56-1007	Dowel Cutter	16 mm	
56-1008	Dowel Cutter	18 mm	
47-1010	Dowel Cutter Center Pins	12 mm	
47-1011	Dowel Cutter Center Pins	14 mm	
47-1012	Dowel Cutter Center Pins	16 mm	
47-1013	Dowel Cutter Center Pin	18 mm	
11-1019	Dowel Cutter Shaft		
80-1001	Dowel Ejector		
11-1011	Dowel Handle and Ejector		
26-1265	Drill Tips, 10 mm		
26-1266	Drill Tips, 12 mm		
26-1267	Drill Tips, 14 mm		
26-1268	Drill Tips, 16 mm		
12-1005C	Cervical Drill Guards, Small		
12-1006C	Cervical Drill Guards, Large		
12-1007	Drill Guard Cap		
28-1001	Drill Shaft, Small		
28-1002	Drill Shaft, Large		
65-1064	Osteophyte Periosteal Elevator		
39-1012	Depth Gauge		
14-1043	Guard Guide, Double-Ended, Small		
14-1044	Guard Guide, Double-Ended, Large		
61-1004	Vertebra Spreader		
80-1012	Spanner Wrench		

Kits



80-1006

PLIF II Instrument Kit

CODE	DESCRIPTION	LENGTH
80-1006	Kit	7 in 178 mm
21-1006	PLIF II Instrument Case	
23-1020C	Cone Ring Curette, Angled 5°, Ring (I.D.) $\frac{5}{16}$ in (8 mm)	9 in 229 mm
65-1056	Periosteal Elevator, No. 1, 4 mm, Sharp	
65-1057	Periosteal Elevator, No. 2, 6 mm, Sharp	
65-1058	Periosteal Elevator, No. 3, 8 mm, Sharp	
65-1121	Periosteal Elevator, Sharp, $\frac{3}{16}$ in	
46-1021	Osteotome, Straight, Blade Width 6 mm	7 $\frac{1}{2}$ in 191 mm
46-1025	Osteotome, Straight, Blade Width 6 mm	9 $\frac{1}{2}$ in 241 mm
46-1019	Osteotome, Straight, Blade Width 10 mm	9 $\frac{1}{2}$ in 241 mm
46-1020	Osteotome, Curved, Blade Width 6 mm	7 $\frac{1}{2}$ in 191 mm
46-1024	Osteotome, Full Curve, Blade Width 6 mm	9 $\frac{1}{2}$ in 241 mm
46-1023	Osteotome, Slightly Curved, Blade Width 8 mm	9 $\frac{1}{2}$ in 241 mm
50-1209	Flexible Nerve Root Retractor, Blade Width $\frac{5}{16}$ in (8 mm)	8 $\frac{1}{2}$ in 216 mm

Kits



Karlin™ XI Magnum Cup Curette

CODE	DESCRIPTION	LENGTH
46-3226	Forward Straight, 7 mm	13¼ in 337 mm
46-3227	Forward Straight, 9 mm	13¼ in 337 mm
46-3228	Forward Straight, 11 mm	13¼ in 337 mm
46-3229	Forward Straight, 13 mm	13¼ in 337 mm
46-3230	Forward Straight, 15 mm	13¼ in 337 mm
46-3236	Forward Straight, 17 mm	13¼ in 337 mm
46-3237	Forward Straight, 19 mm	13¼ in 337 mm
46-3225	Set (12), Extra Long Currettes, Black Handles, Lightweight	13¼ in 337 mm
46-3234	Down Pushing, 7 mm	13¼ in 337 mm
46-3235	Down Pushing, 9 mm	13¼ in 337 mm
46-3231	Forward Angle, 7 mm	13¼ in 337 mm
46-3232	Forward Angle, 9 mm	13¼ in 337 mm
46-3233	Forward Angle, 11 mm	13¼ in 337 mm

Kits

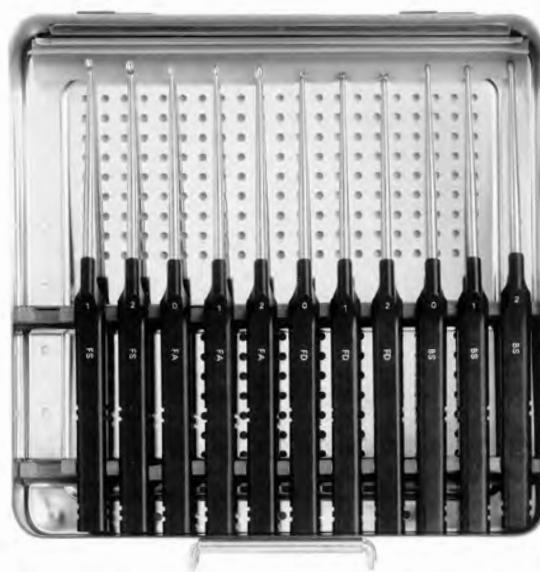

Lumbar Microdiscectomy Set

CODE	DESCRIPTION	LENGTH
46-3120	Lumbar Microdiscectomy Set, 24 Instruments, Set Includes Two Cases	9½ in 241 mm
46-3130	Lumbar Microdiscectomy Curette, Backwards Straight, 0	9½ in 241 mm
46-3131	Lumbar Microdiscectomy Curette, Backwards Straight, 1	9½ in 241 mm
46-3132	Lumbar Microdiscectomy Curette, Backwards Straight, 2	9½ in 241 mm
46-3133	Lumbar Microdiscectomy Curette, Backwards Angle, 0	9½ in 241 mm
46-3134	Lumbar Microdiscectomy Curette, Backwards Angle, 1	9½ in 241 mm
46-3135	Lumbar Microdiscectomy Curette, Backwards Angle, 2	9½ in 241 mm
46-3136	Lumbar Microdiscectomy Curette, Backwards Down, 0	9½ in 241 mm
46-3137	Lumbar Microdiscectomy Curette, Backwards Down, 1	9½ in 241 mm
46-3138	Lumbar Microdiscectomy Curette, Backwards Down, 2	9½ in 241 mm
46-3121	Lumbar Microdiscectomy Curette, Forward Straight, 0	9½ in 241 mm
46-3122	Lumbar Microdiscectomy Curette, Forward Straight, 1	9½ in 241 mm
46-3123	Lumbar Microdiscectomy Curette, Forward Straight, 2	9½ in 241 mm
46-3124	Lumbar Microdiscectomy Curette, Forward Angle, 0	9½ in 241 mm
46-3125	Lumbar Microdiscectomy Curette, Forward Angle, 1	9½ in 241 mm
46-3126	Lumbar Microdiscectomy Curette, Forward Angle, 2	9½ in 241 mm
46-3127	Lumbar Microdiscectomy Curette, Forward Down, 0	9½ in 241 mm
46-3128	Lumbar Microdiscectomy Curette, Forward Down, 1	9½ in 241 mm
46-3129	Lumbar Microdiscectomy Curette, Forward Down, 2	9½ in 241 mm
46-3139	Penfield Dissector, Lumbar #1	9½ in 241 mm
46-3140	Penfield Dissector, Lumbar #2	9½ in 241 mm
46-3142	Penfield Dissector, Lumbar #4	9½ in 241 mm
46-3141	Lumbar Nerve Hook	9½ in 241 mm
46-3143	Lumbar Bone Waxer	9½ in 241 mm
46-3144	Lumbar Probe	9½ in 241 mm
46-3145	Lumbar Microdiscectomy Case, Storage/Sterilizing Case for 12 Instruments	

Kits



Lumbar Spondylophyte Impaction Set

The impaction set is surgeon designed to correct symptomatic spondylophytes. Complementary instruments have been assembled in a set to meet expected indications. Additional (optional) support instruments are available for broader indications

CODE	DESCRIPTION
46-3002	The set includes one each of the following:
46-3003	Display Case
46-3005	Bayonet Dural Suction Retractor, Macro-Tip $\frac{7}{16}$ in (10 mm)
46-3006	Annular Dissector Perforator
46-3007	Offset Central Canal Impactor
46-3009	Lateral Gutter Impactor
46-3012	Black 90° Dural Suction Retractor, Micro-Tip $\frac{5}{16}$ in (8 mm)

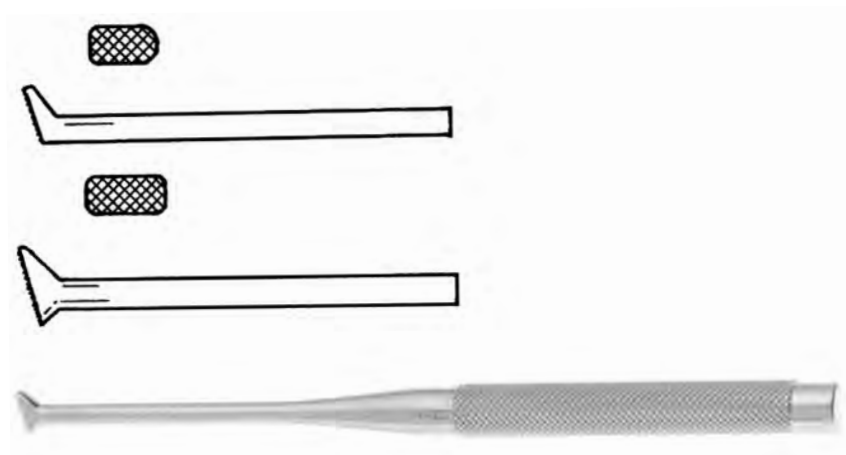

Micro Impactor Set

CODE	DESCRIPTION	LENGTH	
46-3020	Micro Impactor Set	7 in	178 mm
46-3022	Micro Lateral Gutter Impactor, Tip Size $\frac{3}{8}$ in (9.4 mm)	7 in	178 mm
46-3021	Micro Offset Central Canal Impactor, Tip Size $\frac{1}{8}$ in (4.3 mm)	7 in	178 mm

Kits



Magnum Ring Curette Kit

CODE	DESCRIPTION	TIP SIZE	WORKING DISTANCE	HANDLE LENGTH	TOTAL LENGTH
46-3400	Magnum Ring Curettes, Kit with Case				
46-3401	Straight	6 mm	4 ⁷ / ₁₀ in 120 mm	7 ⁴ / ₅ in 200 mm	12 ³ / ₅ in 320 mm
46-3402	Straight	8 mm	4 ⁷ / ₁₀ in 120 mm	7 ⁴ / ₅ in 200 mm	12 ³ / ₅ in 320 mm
46-3403	Straight	10 mm	4 ⁷ / ₁₀ in 120 mm	7 ⁴ / ₅ in 200 mm	12 ³ / ₅ in 320 mm
46-3404	Angle	6 mm	4 ⁷ / ₁₀ in 120 mm	7 ⁴ / ₅ in 200 mm	12 ³ / ₅ in 320 mm
46-3405	Angle	8 mm	4 ⁷ / ₁₀ in 120 mm	7 ⁴ / ₅ in 200 mm	12 ³ / ₅ in 320 mm
46-3406	Angle	10 mm	4 ⁷ / ₁₀ in 120 mm	7 ⁴ / ₅ in 200 mm	12 ³ / ₅ in 320 mm

Kits



Karlin™ Curved Stiletto Osteotome Set with Case

CODE	DESCRIPTION	TIP SIZE	LENGTH
46-3050	Set with Case		8 ½ in 216 mm
46-3051	Curved	¼ in 6 mm	8 ½ in 216 mm
46-3052	Curved	⅜ in 10 mm	8 ½ in 216 mm
46-3053	Curved	½ in 13 mm	8 ½ in 216 mm
46-3054	Curved	⅝ in 16 mm	8 ½ in 216 mm
46-3055	Curved	¾ in 19 mm	8 ½ in 216 mm
46-3056	Case for Curved Stiletto Osteotome		8 ½ in 216 mm



Case for Straight Stiletto Osteotome

CODE	DESCRIPTION	TIP SIZE	LENGTH
46-3060	Case for Straight Stiletto Osteotome		8 ½ in 216 mm
46-3061	Straight	¼ in 6 mm	8 ½ in 216 mm
46-3062	Straight	⅜ in 10 mm	8 ½ in 216 mm
46-3063	Straight	½ in 13 mm	8 ½ in 216 mm
46-3064	Straight	⅝ in 16 mm	8 ½ in 216 mm
46-3065	Straight	¾ in 19 mm	8 ½ in 216 mm
46-3066	Stiletto Straight Osteotome Case		8 ½ in 216 mm

Kits (Transoral)



Crockard™ Transoral Instrument Set

The Crockard™ Transoral Instrument Set is a coordinated set of instruments used to approach a large area of pathology from the sphenoid to the C3 vertebra via the transoral technique.

CODE	DESCRIPTION	QUANTITY
50-1670	Set Includes:	
50-1651	Crockard™ Transoral Retractor Body	1/Each
50-1652	Crockard™ Large Tongue Retractor Blade	1/Each
50-1653	Crockard™ Small Tongue Retractor Blade	1/Each
50-1654	Crockard™ 90° Retractor Blade	2/Each
50-1655	Crockard™ Curved Retractor Blade	2/Each
50-1656	Crockard™ Retractor Blade Connector	2/Each
50-1657	Crockard™ Suction Tube Holder, Short	1/Each
50-1658	Crockard™ Suction Tube Holder, Long	1/Each
50-1659	Crockard™ Hard Palate Retractor	1/Each
50-1660	Crockard™ Pharyngeal Retractor, Small	1/Each
50-1661	Crockard™ Pharyngeal Retractor, Large	1/Each
50-1662	Crockard™ Odontoid Peg Grasping Forceps	1/Each
50-1663	Crockard™ Ligament Grasping Forceps	1/Each
50-1664	Crockard™ Sterilizing/Storage Case	

Kits (Vertebral Body Biopsy)



Craig Vertebral Body Biopsy Kit

CODE	DESCRIPTION	LENGTH
24-2500	Stainless Steel Rack, Includes:	
	Needle, 20 G - For infiltration of operative area	
	Needle, 22 G - For similar use	
	Calibrated Blunt Trocars, Two - For blunt dissection through soft tissues to vertebral body	
	Calibrated Cannula - If X-ray demonstrate trocar is in satisfactory position, cannula is then inserted over it	
	Tooth Cutter - Use within the calibrated cannula to obtain a 3 mm core	
	Sharp Cutter - Use within the calibrated cannula to obtain a 3 mm core	
	Socket Wrench - Used with either cutter	
	Stylet - Used to expel biopsy section	
	Sharp Worm Hook - To withdraw soft tissue cuttings	

Kits



Karlin™ XL Cervical Curette Set

CODE	DESCRIPTION	WORKING DISTANCE	TOTAL LENGTH
46-2625	Curette Set, XL Cervical Microdiscectomy, Set/24		
46-2639	Karlin™ XL Cervical Curette	Backward Straight, 0000	4 1/10 in 104 mm 9 1/2 in 240 mm
46-2638	Karlin™ XL Cervical Curette	Backward Straight, 000	4 1/10 in 104 mm 9 1/2 in 240 mm
46-2637	Karlin™ XL Cervical Curette	Backward Straight, 00	4 1/10 in 104 mm 9 1/2 in 240 mm
46-2636	Karlin™ XL Cervical Curette	Backward Straight, 0	4 1/10 in 104 mm 9 1/2 in 240 mm
46-2644	Karlin™ XL Cervical Curette	Backward Angle, 0000	4 1/10 in 104 mm 9 1/2 in 240 mm
46-2643	Karlin™ XL Cervical Curette	Backward Angle, 000	4 1/10 in 104 mm 9 1/2 in 240 mm
46-2642	Karlin™ XL Cervical Curette	Backward Angle, 00	4 1/10 in 104 mm 9 1/2 in 240 mm
46-2645	Karlin™ XL Cervical Curette	Backward Angle	4 1/10 in 104 mm 9 1/2 in 240 mm
46-2629	Karlin™ XL Cervical Curette	Forward Straight, 0000	4 1/10 in 104 mm 9 1/2 in 240 mm
46-2628	Karlin™ XL Cervical Curette	Forward Straight, 000	4 1/10 in 104 mm 9 1/2 in 240 mm
46-2627	Karlin™ XL Cervical Curette	Forward Straight, 00	4 1/10 in 104 mm 9 1/2 in 240 mm
46-2626	Karlin™ XL Cervical Curette	Forward Straight, 0	4 1/10 in 104 mm 9 1/2 in 240 mm
46-2634	Karlin™ XL Cervical Curette	Forward Angle, 0000	4 1/10 in 104 mm 9 1/2 in 240 mm
46-2633	Karlin™ XL Cervical Curette	Forward Angle, 000	4 1/10 in 104 mm 9 1/2 in 240 mm
46-2632	Karlin™ XL Cervical Curette	Forward Angle, 00	4 1/10 in 104 mm 9 1/2 in 240 mm
46-2631	Karlin™ XL Cervical Curette	Forward Angle, 0	4 1/10 in 104 mm 9 1/2 in 240 mm
46-2640	Karlin™ XL Bone Cutter	Backward Straight	4 1/10 in 104 mm 9 1/2 in 240 mm
46-2630	Karlin™ XL Bone Cutter	Forward Straight	4 1/10 in 104 mm 9 1/2 in 240 mm
46-2635	Karlin™ XL Bone Cutter	Forward Angle	4 1/10 in 104 mm 9 1/2 in 240 mm
46-2646	XL Cervical Micro Nerve Hook		4 1/10 in 104 mm 9 1/2 in 240 mm
46-2647	XL Cervical Ultra™ Micro Nerve Hook		4 1/10 in 104 mm 9 1/2 in 240 mm
46-2648	Cervical Bone Waxer	XL Cervical	4 1/10 in 104 mm 9 1/2 in 240 mm
46-3174	Karlin™ XL Micro Knife Handle		4 1/10 in 104 mm 9 1/2 in 240 mm
46-3145	Storage/Sterilizing Case, For 12 Instruments 2 Provided with Kit		4 1/10 in 104 mm 9 1/2 in 240 mm

Kits



Karlin™ XL Magnum Cobb Elevator Set

CODE	DESCRIPTION	LENGTH
46-3240	Set of Six In Case for 12 Instruments - Includes:	
46-3241	10 mm	13¼ in 337 mm
46-3242	15 mm	13¼ in 337 mm
46-3243	20 mm	13¼ in 337 mm
46-3244	25 mm	13¼ in 337 mm
46-3245	30 mm	13¼ in 337 mm
46-3246	35 mm	13¼ in 337 mm

Kits



Microsect® Curette Kit

CODE	DESCRIPTION		LENGTH	
47-5010	Microsect® Curette Kit, Includes 12 Currettes and Tray			
47-5012	Backward Angle	#1 Curette	10 in	254 mm
47-5014	Backward Angle	#2 Curette	10 in	254 mm
47-5016	Backward Angle	#3 Curette	10 in	254 mm
47-5018	Backward Angle	#4 Curette	10 in	254 mm
47-5020	Backward Angle	#5 Curette	10 in	254 mm
47-5011	Forward Angle	#1 Curette	10 in	254 mm
47-5013	Forward Angle	#2 Curette	10 in	254 mm
47-5015	Forward Angle	#3 Curette	10 in	254 mm
47-5017	Forward Angle	#4 Curette	10 in	254 mm
47-5019	Forward Angle	#5 Curette	10 in	254 mm
47-5021	Straight Dissector	3 mm	10 in	254 mm
47-5022	Straight Dissector	5 mm	10 in	254 mm
47-5023	Microsect® Curette Tray			

Knife Handles

Javelin Micro-Knife Handle

Sold individually and are designed to be used with Karlin™ Micro Tip and Ultra Tip Micro-Knife blades

CODE	TIP	WORKING DISTANCE	LENGTH
46-3177	Micro 2 mm	4 ³ / ₅ in 117 mm	8 ¹ / ₂ in 216 mm
46-3178	Ultra 1.5 mm	4 ³ / ₅ in 117 mm	8 ¹ / ₂ in 216 mm



Karlin™ XL Micro Knife Handle

CODE	HANDLE LENGTH
46-3174	4 ¹ / ₁₀ in 104 mm



Knives

Hardy™ Knife Handle

CODE	DESCRIPTION	WORKING DISTANCE	LENGTH
80-1313	Bayonet, Vertical	3 ¹ / ₂ in 90 mm	8 ¹ / ₁₆ in 205 mm



Mallets (Cervical)

Cervical Hammer

CODE	DESCRIPTION	DIAMETER	LENGTH
88-1005	Small Face, 8 oz	³ / ₄ in 19 mm	7 ¹ / ₂ in 191 mm
88-1006	Large Face, 13 oz	1 in 25 mm	9 in 229 mm



88-1005

Mallets

Heath Mallet

CODE	HEAD DIMENSIONS		DESCRIPTION	LENGTH	
32-3330	2½x1½in	64x40 mm	2lbs 908 g	7¼in	184 mm

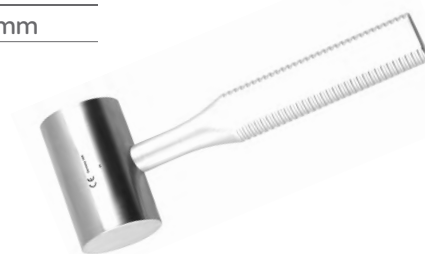

Hibbs Mallet

CODE	DESCRIPTION	DESCRIPTION	LENGTH
88-2520	Solid Brass Head	12 oz 340 g	1½x8in 38x203 mm



Karlin™ Mallet

CODE	DESCRIPTION	WEIGHT	DIAMETER	LENGTH
46-3179	Small	7.1 oz 200 g	1in 25 mm	9½in 241 mm
46-3146	Large	12 oz 340 g	1¼in 32 mm	9¾in 248 mm



Smith-Peterson Mallet, Small

CODE	DESCRIPTION	WEIGHT	LENGTH
88-2500	Solid Brass Head	15 oz 420 g	1½x7in 38x178 mm



Osteotomes (Spinal)

Spinal Fusion Osteotome

CODE	DESCRIPTION	BLADE WIDTH	LENGTH	
28-1022	Straight	8 mm	9 ½ in	241 mm
46-1022	Straight	8 mm	9 ½ in	241 mm
28-1026	Curved	6 mm	9 ½ in	241 mm
46-1026	Curved	6 mm	9 ½ in	241 mm
28-1023	Curved	8 mm	9 ½ in	241 mm



28-1023

Osteotomes

Cherry Osteotome

CODE	DESCRIPTION	BLADE WIDTH	LENGTH	
57-3803	Straight	3 mm	8 in	203 mm
57-3807	Straight	7 mm	8 in	203 mm
57-3813	Curved	3 mm	8 in	203 mm
57-3814	Curved	4 mm	8 in	203 mm
57-3815	Curved	5 mm	8 in	203 mm
57-3816	Curved	6 mm	8 in	203 mm
57-3817	Curved	7 mm	8 in	203 mm

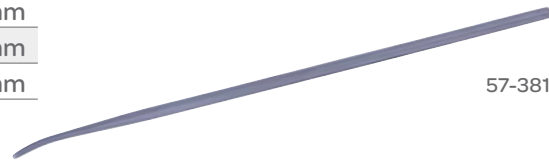

57-3813

Cobb Osteotome

CODE	DESCRIPTION	BLADE WIDTH	LENGTH	
28-7020	Straight	¼ in	11 in	279 mm
28-7021	Straight	⅜ in	11 in	279 mm
28-7022	Straight	½ in	11 in	279 mm
28-7023	Straight	⅝ in	11 in	279 mm
28-7024	Straight	¾ in	11 in	279 mm
28-7025	Straight	1 in	11 in	279 mm



28-7021

Cobb Osteotome

CODE	DESCRIPTION	BLADE WIDTH	LENGTH	
28-7027	Curved	¼ in	11 in	279 mm
28-7028	Curved	⅜ in	11 in	279 mm
28-7029	Curved	½ in	11 in	279 mm
28-7030	Curved	⅝ in	11 in	279 mm
28-7031	Curved	¾ in	11 in	279 mm
28-7032	Curved	1 in	11 in	279 mm
28-7033	Curved	1 ¼ in	11 in	279 mm



28-7027

Osteotomes

Hibbs Osteotome

CODE	DESCRIPTION	BLADE WIDTH		LENGTH	
28-5106	Straight	¼ in	6 mm	9 ½ in	241 mm
28-5110	Straight	⅜ in	10 mm	9 ½ in	241 mm
28-5112	Straight	½ in	13 mm	9 ½ in	241 mm
28-5116	Straight	⅝ in	16 mm	9 ½ in	241 mm
28-5120	Straight	¾ in	19 mm	9 ½ in	241 mm
28-5122	Straight	⅞ in	22 mm	9 ½ in	241 mm
28-5125	Straight	1 in	25 mm	9 ½ in	241 mm
28-5130	Straight	1 ⅛ in	29 mm	9 ½ in	241 mm
28-5132	Straight	1 ¼ in	32 mm	9 ½ in	241 mm
28-5140	Straight	1 ½ in	38 mm	9 ½ in	241 mm



28-5110

Hibbs Osteotome

CODE	DESCRIPTION	BLADE WIDTH		LENGTH	
28-5156	Curved	¼ in	6 mm	9 ½ in	241 mm
28-5160	Curved	⅜ in	10 mm	9 ½ in	241 mm
28-5162	Curved	½ in	13 mm	9 ½ in	241 mm
28-5166	Curved	⅝ in	16 mm	9 ½ in	241 mm
28-5170	Curved	¾ in	19 mm	9 ½ in	241 mm
28-5172	Curved	⅞ in	22 mm	9 ½ in	241 mm
28-5175	Curved	1 in	25 mm	9 ½ in	241 mm
28-5180	Curved	1 ⅛ in	29 mm	9 ½ in	241 mm
28-5182	Curved	1 ¼ in	32 mm	9 ½ in	241 mm
28-5190	Curved	1 ½ in	38 mm	9 ½ in	241 mm



28-5156

Hoke Osteotome

CODE	DESCRIPTION	BLADE WIDTH		LENGTH	
32-3439	Straight	⅛ in	3 mm	6 in	152 mm
32-3435	Straight	¼ in	6 mm	6 in	152 mm
32-3436	Straight	⅜ in	10 mm	6 in	152 mm
32-3437	Straight	½ in	13 mm	6 in	152 mm
32-3438	Straight	⅝ in	16 mm	6 in	152 mm



32-3438

Osteotomes

Hoke Osteotome

CODE	DESCRIPTION	BLADE WIDTH	LENGTH
32-3430	Curved	1/8 in 3 mm	6 in 152 mm
32-3431	Curved	1/4 in 6 mm	6 in 152 mm
32-3432	Curved	1/2 in 13 mm	6 in 152 mm
32-3433	Curved	3/8 in 10 mm	6 in 152 mm
32-3434	Curved	5/8 in 16 mm	6 in 152 mm



32-3431

Hoke Osteotome

CODE	DESCRIPTION	BLADE WIDTH	LENGTH
28-4903	Straight	1/8 in 3 mm	5 1/2 in 140 mm
28-4904	Straight	3/16 in 5 mm	5 1/2 in 140 mm
28-4906	Straight	1/4 in 6 mm	5 1/2 in 140 mm
28-4908	Straight	5/15 in 8 mm	5 1/2 in 140 mm
28-4910	Straight	3/8 in 10 mm	5 1/2 in 140 mm
28-4912	Straight	1/2 in 13 mm	5 1/2 in 140 mm



28-4912

Hoke Osteotome

CODE	DESCRIPTION	BLADE WIDTH	LENGTH
28-4953	Curved	1/8 in 3 mm	5 1/2 in 140 mm
28-4954	Curved	3/16 in 5 mm	5 1/2 in 140 mm
28-4956	Curved	1/4 in 6 mm	5 1/2 in 140 mm
28-4958	Curved	5/15 in 8 mm	5 1/2 in 140 mm
28-4960	Curved	3/8 in 10 mm	5 1/2 in 140 mm
28-4962	Curved	1/2 in 13 mm	5 1/2 in 140 mm



Tip

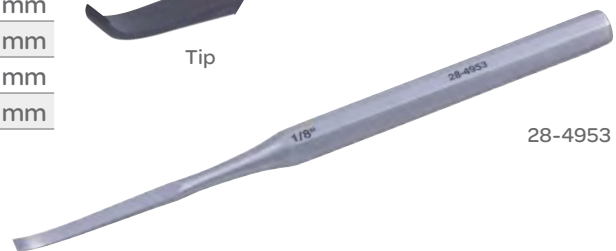

28-4953

Osteotomes

Lambotte Osteotome

CODE	DESCRIPTION	LENGTH
27-5524	Curved with Calibration 4 mm	7¼ in 184 mm
27-5526	Curved with Calibration 6 mm	7¼ in 184 mm



27-5524

Lambotte Osteotome

CODE	DESCRIPTION	LENGTH
27-5502	Straight with Calibration 2 mm	7¼ in 184 mm
27-5504	Straight with Calibration 4 mm	7¼ in 184 mm
27-5505	Straight with Calibration 5 mm	7¼ in 184 mm
27-5506	Straight with Calibration 6 mm	7¼ in 184 mm
27-5508	Straight with Calibration 8 mm	7¼ in 184 mm
27-5510	Straight with Calibration 10 mm	7¼ in 184 mm
27-5512	Straight with Calibration 12 mm	7¼ in 184 mm
27-5516	Straight with Calibration 16 mm	7¼ in 184 mm
27-5519	Straight with Calibration 19 mm	7¼ in 184 mm
27-5522	Straight with Calibration 22 mm	7¼ in 184 mm



27-5512

Osteotomes

Lambotte Osteotome

Without Calibration

CODE	DESCRIPTION	BLADE WIDTH	LENGTH
28-9406	Straight	¼ in 6 mm	9 in 229 mm
28-9412	Straight	½ in 13 mm	9 in 229 mm
28-9420	Straight	¾ in 20 mm	9 in 229 mm
28-9430	Straight	1¼ in 32 mm	9 in 229 mm
28-9440	Straight	1½ in 38 mm	9 in 229 mm



28-9412

Lambotte Osteotome

CODE	DESCRIPTION	BLADE WIDTH	LENGTH
27-5812	Straight	½ in 13 mm	14 in 356 mm



McCulloch Osteotome

CODE	BLADE WIDTH	LENGTH
57-5764	4 mm	8 ½ in
57-5765	6 mm	8 ½ in



57-5764

Osteotomes

Mini-Lambotte Osteotome

Swiss Pattern

CODE	DESCRIPTION	BLADE WIDTH	LENGTH
27-5702	Straight	2 mm	5 1/8 in 130 mm
27-5704	Straight	4 mm	5 1/8 in 130 mm
27-5706	Straight	6 mm	5 1/8 in 130 mm
27-5708	Straight	8 mm	5 1/8 in 130 mm
27-5710	Straight	10 mm	5 1/8 in 130 mm
27-5712	Straight	12 mm	5 1/8 in 130 mm
27-5714	Straight	14 mm	5 1/8 in 130 mm
27-5715	Straight	15 mm	5 1/8 in 130 mm
27-5718	Straight	18 mm	5 1/8 in 130 mm
27-5719	Straight	19 mm	5 1/8 in 130 mm
27-5720	Straight	20 mm	5 1/8 in 130 mm



27-5702

Spinal Fusion Osteotome

CODE	DESCRIPTION	BLADE WIDTH	LENGTH
46-1021	Straight	1/4 in 6 mm	7 1/2 in 191 mm
46-1019	Straight	3/8 in 10 mm	9 1/2 in 241 mm
46-1020	Curved	1/4 in 6 mm	7 1/2 in 191 mm



46-1021

Spinal Fusion Osteotome

CODE	DESCRIPTION	BLADE WIDTH	LENGTH
46-1025	Straight	1/4 in 6 mm	9 1/2 in 241 mm
46-1023	Slightly Curved	1/4 in 6 mm	9 1/2 in 241 mm
46-1024	Full Curve	5/16 in 8 mm	9 1/2 in 241 mm



46-1023

Osteotomes

Osteotome

CODE	DESCRIPTION	BLADE WIDTH		LENGTH	
46-2000	Straight	¼ in	6 mm	11 in	279 mm
46-2001	Straight	⅜ in	10 mm	11 in	279 mm
46-2002	Straight	½ in	13 mm	11 in	279 mm
46-2003	Straight	⅝ in	16 mm	11 in	279 mm
46-2004	Straight	¾ in	19 mm	11 in	279 mm
46-2005	Straight	1 in	25 mm	11 in	279 mm
46-2010	Curved	¼ in	6 mm	11 in	279 mm
46-2011	Curved	⅜ in	10 mm	11 in	279 mm
46-2012	Curved	½ in	13 mm	11 in	279 mm
46-2013	Curved	⅝ in	16 mm	11 in	279 mm
46-2014	Curved	¾ in	19 mm	11 in	279 mm
46-2015	Curved	1 in	25 mm	11 in	279 mm
46-2016	Curved	1¼ in	32 mm	11 in	279 mm



46-2001

Osteotome

CODE	DESCRIPTION	TIP SIZE		LENGTH	
46-3051	Curved	¼ in	6 mm	8½ in	216 mm
46-3052	Curved	⅜ in	10 mm	8½ in	216 mm
46-3053	Curved	½ in	13 mm	8½ in	216 mm
46-3054	Curved	⅝ in	16 mm	8½ in	216 mm
46-3055	Curved	¾ in	19 mm	8½ in	216 mm



46-3052

Sheehan Osteotome

CODE	WIDTH	LENGTH	
27-6202	2 mm	6¼ in	159 mm
27-6204	4 mm	6¼ in	159 mm
27-6206	6 mm	6¼ in	159 mm
27-6208	8 mm	6¼ in	159 mm
27-6210	10 mm	6¼ in	159 mm
27-6215	15 mm	6¼ in	159 mm
27-6218	18 mm	6¼ in	159 mm



27-6202

Osteotomes

Smith-Peterson Osteotome

CODE	DESCRIPTION	TIP SIZE	LENGTH
28-7106	Straight	¼ in 6 mm	8 in 203 mm
28-7112	Straight	½ in 13 mm	8 in 203 mm
28-7115	Straight	⅝ in 16 mm	8 in 203 mm
28-7120	Straight	¾ in 19 mm	8 in 203 mm
28-7125	Straight	1 in 25 mm	8 in 203 mm
28-7130	Straight	1¼ in 32 mm	8 in 203 mm
28-7230	Straight	1⅜ in 30 mm	8 in 203 mm



28-7112

Smith-Peterson Osteotome

CODE	DESCRIPTION	TIP SIZE	LENGTH
28-7156	Curved	¼ in 6 mm	8 in 203 mm
28-7159	Curved	⅜ in 10 mm	8 in 203 mm
28-7162	Curved	½ in 13 mm	8 in 203 mm
28-7165	Curved	⅝ in 15 mm	8 in 203 mm
28-7175	Curved	1 in 25 mm	8 in 203 mm
28-7180	Curved	1¼ in 32 mm	8 in 203 mm
28-7280	Curved	1⅜ in 30 mm	8 in 203 mm



28-7165

Smith-Peterson Osteotome

Blade Thickness 2 mm

CODE	DESCRIPTION	TIP SIZE	LENGTH
46-2500	Straight	¼ in 6 mm	8 in 203 mm
46-2501	Straight	⅜ in 10 mm	8 in 203 mm
46-2502	Straight	½ in 13 mm	8 in 203 mm
46-2503	Straight	⅝ in 15 mm	8 in 203 mm
46-2504	Straight	¾ in 19 mm	8 in 203 mm
46-2505	Straight	1 in 25 mm	8 in 203 mm
46-2506	Straight	1¼ in 32 mm	8 in 203 mm



46-2500

Osteotomes

Smith-Peterson Osteotome

Blade Thickness 2 mm

CODE	DESCRIPTION	TIP SIZE	LENGTH
46-2510	Curved	¼ in 6 mm	8 in 203 mm
46-2511	Curved	⅜ in 10 mm	8 in 203 mm
46-2512	Curved	½ in 13 mm	8 in 203 mm
46-2513	Curved	⅝ in 16 mm	8 in 203 mm
46-2514	Curved	¾ in 19 mm	8 in 203 mm
46-2515	Curved	1 in 25 mm	8 in 203 mm
46-2516	Curved	1¼ in 32 mm	8 in 203 mm



46-2511

Karlin™ Stiletto Osteotome

CODE	DESCRIPTION	TIP SIZE	LENGTH
46-3061	Straight	¼ in 6 mm	8½ in 216 mm
46-3062	Straight	⅜ in 10 mm	8½ in 216 mm
46-3063	Straight	½ in 13 mm	8½ in 216 mm
46-3064	Straight	⅝ in 16 mm	8½ in 216 mm
46-3065	Straight	¾ in 19 mm	8½ in 216 mm



46-3061

Stille Osteotome

CODE	DESCRIPTION	TIP SIZE	LENGTH
28-4404	Straight	4 mm	8 in 203 mm
28-4408	Straight	8 mm	8 in 203 mm
28-4410	Straight	10 mm	8 in 203 mm
28-4412	Straight	12 mm	8 in 203 mm
28-4414	Straight	14 mm	8 in 203 mm
28-4418	Straight	18 mm	8 in 203 mm
28-4422	Straight	22 mm	8 in 203 mm
28-4465	Curved	15 mm	8 in 203 mm
28-4470	Curved	20 mm	8 in 203 mm
28-4475	Curved	25 mm	8 in 203 mm



28-4404

US Army Osteotome

CODE	DESCRIPTION	TIP SIZE	LENGTH
28-2106		6 mm	6¼ in 159 mm
28-2112		12 mm	6¼ in 159 mm

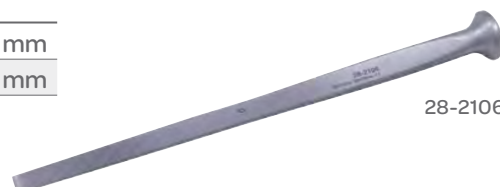

28-2106

Packers (Bone Chip)

Bone Chip Packer

CODE	DESCRIPTION	LENGTH	
27-9412	2.3 x 9.5 mm	10 in	254 mm
27-9411	3.1 x 15.8 mm	10 in	254 mm
27-9413	6.3 x 9.5 mm	10 in	254 mm
27-9415	6.3 mm Round	9 ½ in	241 mm



27-9411

Packers

Woodson Separator-Packer

Double-Ended with Grooved Blade

CODE	BLADE WIDTH		BLADE DEPTH		LENGTH	
65-1135	⅛ in	3 mm	½ in	13 mm	7 in	178 mm



Pins (Distraction)

Caspar Distraction Pin

Sold individually

CODE	DIAMETER
57-5106	12 mm
57-5107	14 mm
57-5100	18 mm



57-5100

Probes (Ball)

McCulloch Ball Probe

CODE	DESCRIPTION	LENGTH	
57-5722	4 mm Angled Tip	9 ½ in	241 mm
57-5723	7 mm Angled Tip	9 ½ in	241 mm

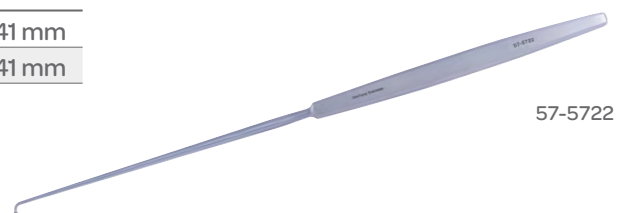

57-5722

Probes (Foraminal)

McCulloch Foraminal Probe

CODE	TIP	LENGTH
57-5760	18 mm	9½ in 241 mm



Probes (Lumbar)

Lumbar Probe

CODE	DESCRIPTION	LENGTH
46-3144	Spinal Probe	9½ in 241 mm

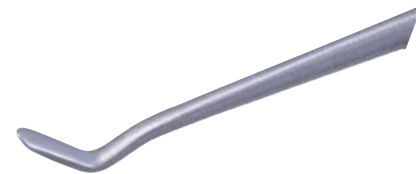

Rasps (Bone)

Miller Bone Rasp

CODE	DESCRIPTION	LENGTH
26-1012	5 mm and 7 mm, Double-Ended	7¼ in 184 mm



Putti Bone Rasp

Double-Ended Flat Blades, 18 mm Width Tapers to 4 mm One End Curved Up, One End Curved Sideways

CODE	DESCRIPTION	LENGTH
26-1501	Straight and Curved	10½ in 265 mm



Putti Bone Rasp

Double-Ended, One 10 mm Round Blade Tapers to 4 mm and One 15 mm Half-Round Blade Tapers to 5 mm

CODE	DESCRIPTION	LENGTH
26-1502	Round and Half Round	12 in 305 mm



Retractors

Caspar Retractor

Black Finish

CODE	DESCRIPTION	LENGTH
57-5651-65	Micro Lumbar	65 mm
57-5651-75	Micro Lumbar	75 mm
57-5651-85	Micro Lumbar	85 mm



57-5651-65

Caspar Retractor

CODE	DESCRIPTION	LENGTH
57-5657F	Counter-Retractor Frame Only	
57-5652	Blade Only	40 mm
57-5653	Blade Only	45 mm
57-5654	Blade Only	50 mm
57-5655	Blade Only	55 mm
57-5656	Blade Only	60 mm
57-5657	Blade Only	65 mm
57-5658	Blade Only	75 mm
57-5658-85	Blade Only	85 mm



57-5657F

Caspar Type Counter Retractor

CODE	DESCRIPTION	LENGTH
57-5651	Blade Only	35 mm



Cloward Style Double Hinge Retractor

CODE
57-5602

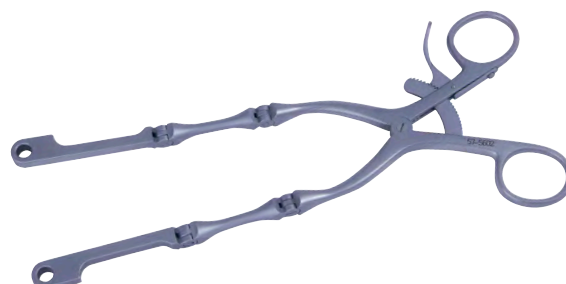

Retractors

Hibbs Retractor

CODE	DESCRIPTION	LENGTH
23-6381	1x3 in 25 x 75 mm	9 in 229 mm



Horizontal Retractor

CODE	DESCRIPTION	LENGTH
24-3500	4 x 2 Sharp Prongs	12 in 305 mm

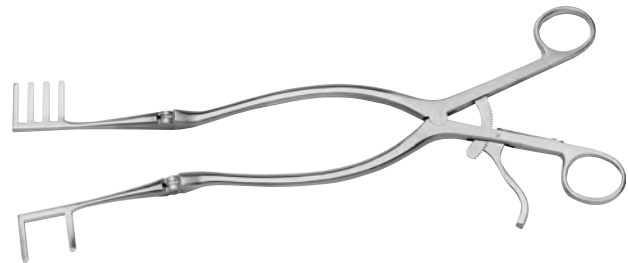

Markham-Meyerding Retractor

Self-Retaining

CODE	DESCRIPTION	BLADE WIDTH	BLADE DEPTH	TOTAL OPENING	LENGTH
50-1205	Left	1 in 25 mm	2 in 51 mm	3 ¾ in 95 mm	7 in
50-1206	Right	1 in 25 mm	2 in 51 mm	3 ¾ in 95 mm	7 in



50-1205

Oberhill Retractor

Hinged Blades

CODE	DESCRIPTION	LENGTH
24-3449	4 Prong	13 in 355 mm



Retractors

Ribbon Retractor

Double-Ended, Malleable

CODE	WIDTH	LENGTH	CODE	WIDTH	LENGTH
22-0006	¼ in 6 mm	8 in 203 mm	22-0253	1¼ in 32 mm	13 in 330 mm
22-0012	½ in 13 mm	8 in 203 mm	22-0254	1½ in 38 mm	13 in 330 mm
22-0017	⅝ in 16 mm	8 in 203 mm	22-0255	2 in 51 mm	13 in 330 mm
22-0025	1 in 25 mm	8 in 203 mm	22-0256	2½ in 64 mm	13 in 330 mm
22-0027	1 in 25 mm	10 in 254 mm	22-0257	3 in 76 mm	13 in 330 mm
22-0035	1¾ in 44 mm	10 in 254 mm	22-0258	4 in 102 mm	13 in 330 mm
22-0251	¾ in 19 mm	13 in 330 mm	22-0259	5 in 127 mm	13 in 330 mm
22-0252	1 in 25 mm	13 in 330 mm			

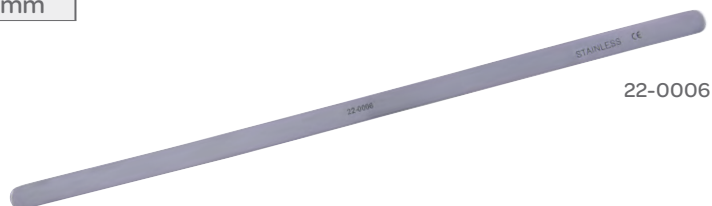

22-0006

Scoville Hook with Bar

CODE	CROSSBAR LENGTH	LENGTH
13-1064	1 in 25 mm	1½ in 38 mm
13-1065	1 in 25 mm	2⅜ in 56 mm
13-1066	1 in 25 mm	2⅝ in 75 mm



13-1064

Senn Retractor

Double-Ended

CODE	DESCRIPTION	LENGTH
20-0508	Sharp	6¼ in 160 mm
20-0509	Blunt	6¼ in 160 mm



20-0508

Retractors

Ultra™ ReVeal Basic View Retractor System

CODE	DESCRIPTION
59-2000	Complete Set



Ultra™ Side Loading Transverse Retractor

CODE	DESCRIPTION	DIMENSION
59-0100	With Double Hinge	120 mm Rack



Ultra™ Side-Loading Longitudinal Retractor

CODE	DESCRIPTION	LENGTH
59-0101	With Double Hinge	



US Army Retractors

Double-Ended

CODE	BLADE WIDTH		BLADE DEPTH		LENGTH
50-4071	1 3/4 in	44 mm	5/16 in	14 mm	8 5/16 in 211 mm
	1 1/4 in	32 mm	5/16 in	14 mm	



Retractor Systems (Cervical)



59-0600



Ultra™ ReVeal ACF Distraction System

Complete System: Tray One of Three

CODE	DESCRIPTION	COLOR	LENGTH		QUANTITY
59-0000	Complete ACF Retractor System				1
59-0600	Ultra™ ReVeal 3 Tray Case				1
59-0030	ACF Blade, Blunt	Silver	1½ in	30 mm	2
59-0031	ACF Blade, Blunt	Blue	1¾ in	35 mm	2
59-0032	ACF Blade, Blunt	Red	1⅝ in	40 mm	2
59-0033	ACF Blade, Blunt	Green	1¾ in	45 mm	2
59-0034	ACF Blade, Blunt	Violet	2 in	50 mm	2
59-0035	ACF Blade, Blunt	Black	2⅛ in	55 mm	2
59-0036	ACF Blade, Blunt	Gold	2⅜ in	60 mm	2
59-0037	ACF Blade, Blunt	Navy	2½ in	65 mm	2
59-0038	ACF Blade, Blunt	Light Green	2¾ in	70 mm	2
59-0039	ACF Blade, Blunt	Orange	3 in	75 mm	2
59-0080	ACF Micro Blade, Blunt	Blue	9/16 x 1⅜ in	14 x 35 mm	2
59-0081	ACF Micro Blade, Blunt	Red	9/16 x 1⅝ in	14 x 40 mm	2
59-0082	ACF Micro Blade, Blunt	Green	9/16 x 1¾ in	14 x 45 mm	2
59-0083	ACF Micro Blade, Blunt	Violet	9/16 x 2⅛ in	14 x 50 mm	2
59-0084	ACF Micro Blade, Blunt	Black	9/16 x 2⅛ in	14 x 55 mm	2
59-0085	ACF Micro Blade, Blunt	Gold	9/16 x 2⅛ in	14 x 50 mm	2
59-0090	ACF Micro Blade, Short Teeth	Blue	9/16 x 1⅜ in	14 x 35 mm	2
59-0091	ACF Micro Blade, Short Teeth	Red	9/16 x 1⅝ in	14 x 40 mm	2
59-0092	ACF Micro Blade, Short Teeth	Green	9/16 x 1¾ in	14 x 45 mm	2
59-0093	ACF Micro Blade, Short Teeth	Violet	9/16 x 2⅛ in	14 x 50 mm	2
59-0094	ACF Micro Blade, Short Teeth	Black	9/16 x 2⅛ in	14 x 55 mm	2
59-0095	ACF Micro Blade, Short Teeth	Gold	9/16 x 2⅜ in	14 x 60 mm	2
59-0106	ACF Color Coded Depth Gauge				1
59-0105	Blade Loading Locking Retractor Handle				2

Retractor Systems (Cervical)



Ultra™ ReVeal ACF Removal Body Tray

Tray Two of Three

CODE	DESCRIPTION	COLOR	LENGTH	QUANTITY
59-0000	Complete ACF Retractor System			1
59-0050	ACF Blade, Short Teeth	Silver	1 1/8 in 30 mm	1
59-0051	ACF Blade, Short Teeth	Blue	1 3/8 in 35 mm	1
59-0052	ACF Blade, Short Teeth	Red	1 5/8 in 40 mm	1
59-0053	ACF Blade, Short Teeth	Green	1 3/4 in 45 mm	1
59-0054	ACF Blade, Short Teeth	Violet	2 in 50 mm	1
59-0055	ACF Blade, Short Teeth	Black	2 1/8 in 55 mm	1
59-0056	ACF Blade, Short Teeth	Gold	2 3/8 in 60 mm	1
59-0057	ACF Blade, Short Teeth	Navy	2 1/2 in 65 mm	1
59-0070	ACF Blade, Long Teeth	Silver	1 1/8 in 30 mm	1
59-0071	ACF Blade, Long Teeth	Blue	1 3/8 in 35 mm	1
59-0072	ACF Blade, Long Teeth	Red	1 5/8 in 40 mm	1
59-0073	ACF Blade, Long Teeth	Green	1 3/4 in 45 mm	1
59-0074	ACF Blade, Long Teeth	Violet	2 in 50 mm	1
59-0075	ACF Blade, Long Teeth	Black	2 1/8 in 55 mm	1
59-0076	ACF Blade, Long Teeth	Gold	2 3/8 in 60 mm	1
59-0077	ACF Blade, Long Teeth	Navy	2 1/2 in 65 mm	1
59-0101	Side-Loading Longitudinal Retractor, with Double Hinge			1
59-0100	Side-Loading Transverse Retractor, with Double Hinge		4 3/4 in 120 mm	1
59-0113	Screw Driver			2
59-0109	Twist Drill			2

Retractor Systems (Cervical)



Ultra™ ReVeal ACF Cervical Retractor Tray

Tray Three of Three

CODE	DESCRIPTION	QUANTITY
59-0000	Complete ACF Retractor System	1
59-0131	Bone Graft Holder	1
59-0117	Distractor Single Level, Left with 3 ¹⁵ / ₁₆ in (100 mm) Rack	1
59-0118	Distractor Single Level, Right with 3 ¹⁵ / ₁₆ in (100 mm) Rack	1
59-0116	Distractor Multiple Level, Left with 4 ³ / ₄ in (120 mm) Rack	1
59-0115	Distractor Multiple Level, Right with 4 ³ / ₄ in (120 mm) Rack	1
59-0111	Drill Guide, Left for 59-0116/59-0117	1
59-0110	Drill Guide, Right for 59-0118/59-0115	1
59-0120	ACF Caliper	1
59-0124	ACF Bone Graft Harvesting Forcep, ³ / ₁₁ in (7 mm)	1
59-0121	ACF Bone Tamp, ¹ / ₈ in (3 mm)	1
59-0122	ACF Bone Tamp, ¹ / ₅ in (5 mm)	1
59-0123	ACF Bone Tamp, ⁵ / ₁₆ in (8 mm)	1

Retractor Systems (Cervical)



Ultra™ ReVeal LoPro Retractor Tray

CODE	DESCRIPTION	LENGTH		QUANTITY
59-3000	Complete LoPro Retractor System			
59-2001	Cervical Retractor Frame, Right			1
59-2002	Cervical Retractor Frame, Left			1
59-2003	Cervical Retractor Frame, Offset			1
59-2006	Cervical Retractor Blade, Pronged	$\frac{7}{8} \times 1$ in	22 x 25 mm	2
59-2007	Cervical Retractor Blade, Pronged	$\frac{7}{8} \times 1\frac{1}{8}$ in	22 x 30 mm	2
59-2008	Cervical Retractor Blade, Pronged	$\frac{7}{8} \times 1\frac{3}{8}$ in	22 x 35 mm	2
59-2009	Cervical Retractor Blade, Pronged	$\frac{7}{8} \times 1\frac{5}{8}$ in	22 x 40 mm	2
59-2010	Cervical Retractor Blade, Pronged	$\frac{7}{8} \times 1\frac{3}{4}$ in	22 x 45 mm	2
59-2011	Cervical Retractor Blade, Pronged	$\frac{7}{8} \times 2\frac{1}{8}$ in	22 x 50 mm	2
59-2012	Cervical Retractor Blade, Pronged	$\frac{7}{8} \times 2\frac{1}{8}$ in	22 x 55 mm	2
59-2013	Cervical Retractor Blade, Pronged	$\frac{7}{8} \times 2\frac{3}{8}$ in	22 x 60 mm	2
59-2014	Cervical Retractor Blade, Pronged	$\frac{7}{8} \times 2\frac{1}{2}$ in	22 x 65 mm	2
59-2015	Cervical Retractor Blade, Pronged	$\frac{7}{8} \times 2\frac{3}{4}$ in	22 x 70 mm	2
59-2016	Cervical Retractor Blade, Pronged	$\frac{7}{8} \times 3$ in	22 x 75 mm	2
59-2017	Cervical Retractor Blade, Blunt	$\frac{7}{8} \times 1$ in	22 x 25 mm	2
59-2018	Cervical Retractor Blade, Blunt	$\frac{7}{8} \times 1\frac{1}{8}$ in	22 x 30 mm	2
59-2019	Cervical Retractor Blade, Blunt	$\frac{7}{8} \times 1\frac{3}{8}$ in	22 x 35 mm	2
59-2020	Cervical Retractor Blade, Blunt	$\frac{7}{8} \times 1\frac{5}{8}$ in	22 x 40 mm	2
59-2021	Cervical Retractor Blade, Blunt	$\frac{7}{8} \times 1\frac{3}{4}$ in	22 x 45 mm	2
59-2023	Cervical Retractor Blade, Blunt	$\frac{7}{8} \times 2\frac{1}{8}$ in	22 x 50 mm	2
59-2024	Cervical Retractor Blade, Blunt	$\frac{7}{8} \times 2\frac{1}{8}$ in	22 x 55 mm	2
59-2025	Cervical Retractor Blade, Blunt	$\frac{7}{8} \times 2\frac{3}{8}$ in	22 x 60 mm	2
59-2026	Cervical Retractor Blade, Bi-Leveled Pronged	$1\frac{1}{16} \times 1\frac{1}{8}$ in	27 x 30 mm	4
59-2027	Cervical Retractor Blade, Bi-Leveled Blunt	$1\frac{1}{16} \times 1\frac{1}{8}$ in	27 x 30 mm	2
59-2028	Cervical Retractor Blade, Bi-Leveled Pronged	$1\frac{1}{16} \times 1\frac{5}{8}$ in	27 x 40 mm	4
59-2029	Cervical Retractor Blade, Bi-Leveled Blunt	$1\frac{1}{16} \times 1\frac{5}{8}$ in	27 x 40 mm	2
59-2035	Cervical Retractor Blade, Bi-Leveled Pronged	$1\frac{1}{16} \times 1\frac{3}{4}$ in	27 x 45 mm	4
59-2036	Cervical Retractor Blade, Bi-Leveled Blunt	$1\frac{1}{16} \times 1\frac{3}{4}$ in	27 x 45 mm	2
59-2037	Micro Discectomy Adaptor for ACF Retractor Set			1
59-2038	Spike Blade	$2\frac{3}{4}$ in	70 mm	1
59-2039	T-Shaped Blade	$2\frac{3}{4}$ in	70 mm	1
59-2004	Inner Spinal Ligament			1
59-2005	Blade Holding Retractor			2
59-2040	Case			1

Retractor Systems (Cervical)



Ultra™ ReVeal Lumbar Instrument System

Tray One of Three

CODE	DESCRIPTION	LENGTH		QUANTITY
59-1000S	Ultra™ ReVeal Lumbar Instrument Tray			1
59-1104	Scoville Lumbar Retractor, Double Hinged	7 $\frac{7}{8}$ in	200 mm	1
59-1100	Lumbar Retractor Body for Multiple Blades			1
59-1103	Side-Loading Lumbar Retractor Blade Holder			4
59-1102	Lumbar Retractor Adjustable Blade Holder			4
59-1001	Lumbar Retractor T-Handle			1
59-1105	Side-Loading Locking Retractor Handle			2
59-1080	Hook, Sharp Toothed Shaft	1 $\frac{5}{8}$ in	40 mm	1
59-1081	Hook, Sharp Toothed Shaft	2 in	50 mm	1
59-1082	Hook, Sharp Toothed Shaft	2 $\frac{3}{8}$ in	60 mm	1
59-1083	Hook, Sharp Toothed Shaft	2 $\frac{3}{4}$ in	70 mm	1
59-1084	Lumbar Spinal T-Bar	1 x 1 $\frac{5}{8}$ in	25 x 40 mm	1
59-1085	Lumbar Spinal T-Bar	1 x 2 in	25 x 50 mm	1
59-1086	Lumbar Spinal T-Bar	1 x 2 $\frac{3}{8}$ in	25 x 60 mm	1
59-1087	Lumbar Spinal T-Bar	1 x 2 $\frac{3}{4}$ in	25 x 70 mm	1



Ultra™ ReVeal Multi-Level Retractor System

Tray Two of Three

CODE	DESCRIPTION	LENGTH		QUANTITY
59-1030	Blade Angled Out 15°, with Teeth, Titanium	$10\frac{1}{11}$ x 1 $\frac{3}{8}$ in	23 x 35 mm	4
59-1031	Blade Angled Out 15°, with Teeth, Titanium	$10\frac{1}{11}$ x 1 $\frac{3}{4}$ in	23 x 45 mm	4
59-1032	Blade Angled Out 15°, with Teeth, Titanium	$10\frac{1}{11}$ x 2 $\frac{1}{8}$ in	23 x 55 mm	4
59-1033	Blade Angled Out 15°, with Teeth, Titanium	$10\frac{1}{11}$ x 2 $\frac{1}{2}$ in	23 x 65 mm	4
59-1034	Blade Angled Out 15°, with Teeth, Titanium	$10\frac{1}{11}$ x 3 in	23 x 75 mm	4
59-1035	Blade Angled Out 15°, with Teeth, Titanium	$10\frac{1}{11}$ x 3 $\frac{3}{8}$ in	23 x 85 mm	4
59-1036	Blade Angled Out 15°, with Teeth, Titanium	$10\frac{1}{11}$ x 3 $\frac{15}{16}$ in	23 x 100 mm	4
59-1037	Blade Angled Out 15°, with Teeth, Titanium	$10\frac{1}{11}$ x 4 $\frac{3}{4}$ in	23 x 120 mm	4

Retractor Systems (Cervical)

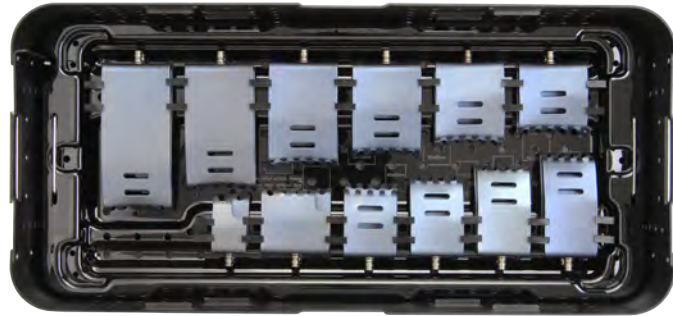

Ultra™ ReVeal Lumbar Instrument System

Tray Three of Three

CODE	DESCRIPTION	LENGTH		QUANTITY
59-1050	Blade Angled Out 15°, with Teeth, Titanium	1¾ x 2 in	45 x 50 mm	2
59-1051	Blade Angled Out 15°, with Teeth, Titanium	1¾ x 2⅜ in	45 x 60 mm	2
59-1052	Blade Angled Out 15°, with Teeth, Titanium	1¾ x 2¾ in	45 x 70 mm	2
59-1053	Blade Angled Out 15°, with Teeth, Titanium	1¾ x 3⅛ in	45 x 80 mm	2
59-1056	Blade Angled Out 15°, with Teeth, Titanium	2⅜ x 2 in	60 x 50 mm	2
59-1057	Blade Angled Out 15°, with Teeth, Titanium	2⅜ x 2⅜ in	60 x 60 mm	2
59-1058	Blade Angled Out 15°, with Teeth, Titanium	2⅜ x 2¾ in	60 x 70 mm	2
59-1059	Blade Angled Out 15°, with Teeth, Titanium	2⅜ x 3⅛ in	60 x 80 mm	2
59-1060	Blade Angled Out 15°, with Teeth, Titanium	2⅜ x 3⅛ in	60 x 100 mm	2
59-1061	Blade Angled Out 15°, with Teeth, Titanium	2⅜ x 4¾ in	60 x 120 mm	2
59-1070	Blade Sacral Cutout with Teeth, Titanium, Right	1¼ x 1⅝ in	30 x 40 mm	1
59-1071	Blade Sacral Cutout with Teeth, Titanium, Left	1¼ x 1⅝ in	30 x 40 mm	1
59-1072	Blade Sacral Cutout with Teeth, Titanium, Right	2⅜ x 1¾ in	60 x 45 mm	1
59-1073	Blade Sacral Cutout with Teeth, Titanium, Left	2⅜ x 1¾ in	60 x 45 mm	1
59-1700	Case			1

Retractor Systems (Cervical)



Anterior Cervical Fusion Kit with Case

CODE	DESCRIPTION
11-1011	Set Includes
80-1004	Anterior Fusion Kit Includes the Following Items:
21-1001	Instrument Case
11-1002	Cross Bar Handle (two each)
56-1005	12 mm Diameter Dowel Cutter
56-1006	14 mm Diameter Dowel Cutter
56-1007	16 mm Diameter Dowel Cutter
56-1008	18 mm Diameter Dowel Cutter
47-1010	12 mm Dowel Cutter Center Pin
47-1011	14 mm Dowel Cutter Center Pin
47-1012	16 mm Dowel Cutter Center Pin
47-1013	18 mm Dowel Cutter Center Pin
11-1019	Dowel Cutter Shaft
80-1001	Dowel Ejector
11-1011	Dowel Handle and Ejector
26-1265	10 mm Drill Tip
26-1266	12 mm Drill Tip
26-1267	14 mm Drill Tip
26-1268	16 mm Drill Tip
12-1005C	Small Cervical Drill Guard
12-1006C	Large Cervical Drill Guard
12-1007	Drill Guard Cap
28-1001	Small Drill Shaft
28-1002	Large Drill Shaft
65-1064	Osteophyte Periosteal Elevator
39-1012	Depth Gauge
14-1043	Small Guard Guide, Double-Ended
14-1044	Large Guard Guide, Double-Ended
61-1004	Vertebra Spreader
80-1012	Spanner Wrench

Retractor Systems (Components)



59-0022

Ultra™ ACF Blade

CODE	DESCRIPTION	COLOR	LENGTH
59-0022	ACF Blade, Blunt		20 mm
59-0030	ACF Blade, Blunt	Silver	1 $\frac{1}{8}$ in 30 mm
59-0031	ACF Blade, Blunt	Blue	1 $\frac{3}{8}$ in 35 mm
59-0032	ACF Blade, Blunt	Red	1 $\frac{5}{8}$ in 40 mm
59-0034	ACF Blade, Blunt	Violet	2 in 50 mm
59-0036	ACF Blade, Blunt	Gold	2 $\frac{3}{8}$ in 60 mm
59-0037	ACF Blade, Blunt	Navy	2 $\frac{1}{2}$ in 65 mm
59-0038	ACF Blade, Blunt	Light Green	2 $\frac{3}{4}$ in 70 mm
59-0039	ACF Blade, Blunt	Orange	3 in 75 mm
59-0041	ACF Blade, Blunt		80 mm
59-0055	ACF Micro Blade, Short Teeth	Black	$\frac{9}{16}$ x 1 $\frac{3}{8}$ in 14 x 55 mm
59-0071	ACF Micro Blade, Long Teeth	Black	35 mm
59-0074	ACF Micro Blade, Long Teeth	Violet	50 mm
59-0075	ACF Micro Blade, Long Teeth	Black	55 mm

Cervical Retractor Blade

Lo Pro Blades in Retractor

CODE	DESCRIPTION	LENGTH
59-2010	Pronged	22 x 45 mm
59-2001	Right	

See our retractor section, in this catalog, for a complete line of cervical retractor blades.



59-2010

Retractor Systems (Components)

Ultra™ ReVeal Lumbar Instrument Blades

CODE	DESCRIPTION	DIMENSIONS		QUANTITY
59-1030	Blade Angled Out 15°	$10\frac{1}{11}$ x $1\frac{3}{8}$ in	23 x 35 mm	4
59-1031	Blade Angled Out 15°	$10\frac{1}{11}$ x $1\frac{3}{4}$ in	23 x 45 mm	4
59-1032	Blade Angled Out 15°	$10\frac{1}{11}$ x $2\frac{1}{8}$ in	23 x 55 mm	4
59-1033	Blade Angled Out 15°	$10\frac{1}{11}$ x $2\frac{1}{2}$ in	23 x 65 mm	4
59-1034	Blade Angled Out 15°	$10\frac{1}{11}$ x 3 in	23 x 75 mm	4
59-1035	Blade Angled Out 15°	$10\frac{1}{11}$ x $3\frac{3}{8}$ in	23 x 85 mm	4
59-1036	Blade Angled Out 15°	$10\frac{1}{11}$ x $3\frac{15}{16}$ in	23 x 100 mm	4
59-1037	Blade Angled Out 15°	$10\frac{1}{11}$ x $4\frac{3}{4}$ in	23 x 120 mm	4

Retractors

Caspar Lateral Blade

With Teeth

CODE	DIMENSIONS (W X L)
57-5668L	55 x 23 mm
57-5669L	60 x 23 mm



57-5668L

Caspar Retractor Blade Ejector

CODE	DIMENSIONS (L X W)	NO. OF TEETH	TIP CURVE
57-5690	60 x 60 mm	6	30 mm



Cervical Retractor

With Lip

CODE	DESCRIPTION	LENGTH	
50-1050	18 mm	3 x $4\frac{1}{2}$ in	76 x 114 mm
50-1052	20 mm	3 x $4\frac{1}{2}$ in	76 x 114 mm
50-1053	23 mm	3 x $4\frac{1}{2}$ in	76 x 114 mm



50-1052

Retractor Systems (Components)



Cloward Blade Retractor With Lip

Add "M" to Code Number for Blade without Lip

57-5498

CODE	DESCRIPTION	LENGTH	
57-5497	13 mm	7½ in	191 mm
57-5498	18 mm	7½ in	191 mm
57-5499	20 mm	7½ in	191 mm
57-5500	23 mm	7½ in	191 mm

Crank Frame Retractor Blade

CODE	DESCRIPTION	LENGTH	
46-3206	Semi Hemi	1¼ x 1¼ in	31 x 31 mm
46-3207	Semi Hemi	2 x 1¼ in	51 x 31 mm
46-3199	Left and Right Pair, Offset	¾ x 1¼ in	19 x 31 mm
46-3200	Left and Right Pair, Offset	¾ x 1¾ in	19 x 44 mm
46-3201	Left and Right Pair, Offset	¾ x 2¼ in	19 x 57 mm
46-3202	Left and Right Pair, Offset	¾ x 3 in	19 x 76 mm
46-3203	Left and Right Pair, Offset	¾ x 3¾ in	19 x 83 mm
46-3204	Left and Right Pair, Offset	¾ x 4 in	19 x 102 mm
46-3205	Left and Right Pair, Offset	2 x 4 in	51 x 102 mm



Crockard™ Curved Retractor Blade

CODE	TIP WIDTH	BLADE LENGTH	LENGTH
50-1655	½ in 12 mm	1½ in 38 mm	5 in 127 mm



Crockard™ Retractor Blade

CODE	DESCRIPTION	BLADE WIDTH	BLADE LENGTH	LENGTH
50-1654	90°	½ in 20 mm	1½ in 38 mm	5 in 127 mm



Retractor Systems (Components)

Retractor Blade

Set of Two

CODE	DESCRIPTION	LENGTH
46-3197	Left/Right	3 x 2½ in 76 x 64 mm



Retractor Blades for Cervical Retractor Body

CODE	DESCRIPTION	LENGTH
50-1381	Sharp	1 in 25 mm
50-1382	Sharp	1½ in 30 mm
50-1383	Sharp	1¾ in 35 mm
50-1384	Sharp	1⅘ in 40 mm
50-1385	Sharp	1⅚ in 45 mm
50-1386	Sharp	2 50 mm
50-1387	Sharp	2⅕ in 55 mm



50-1383

Scoville Retractor Blade

CODE	DESCRIPTION	BLADE WIDTH	BLADE DEPTH
13-1009		2 in 51 mm	2½ in 64 mm
13-1008		1 in 25 mm	2½ in 64 mm
13-1010		1⅛ in 29 mm	2⅝ in 67 mm
13-1011		1 in 25 mm	3½ in 89 mm
13-1012	Four Prong	1½ in 38 mm	1⅝ in 41 mm
13-1013	Four Prong	1¾ in 44 mm	2⅝ in 67 mm



13-1013

Ultra™ Blade

CODE	DESCRIPTION
59-0105	Loading Locking Retractor Handle



Retractor Systems (Bookwalter®)



Bookwalter® Spinal Retractor Kit, 12 inch Post (305 mm)

CODE	DESCRIPTION	DIMENSIONS	
50-4631	Bookwalter® Spinal Retractor Kit includes the following:		
50-4581	Table Post, 1 in (25 mm) Diameter Post		
50-4582	Horizontal Flex Bar		
50-4635	Round Segmented Ring, Small (Pair)	8 ½ in	216 mm
50-4636	Straight Ring Segment (Pair)	4 in	102 mm
50-4637	Straight Ring Segment (Pair)	6 in	152 mm
50-4638	Straight Ring Segment (Pair)	8 in	203 mm
50-4580	Tilt Ratchets (6/each)		
50-4639	Bookwalter® Scoville Hook, Small, Qty 2	3 ¼ in	83 mm
50-4640	Bookwalter® Scoville Hook, Large, Qty 2	2 in	50 mm
50-4641	Bookwalter®-Meyerding Retractor Blade, Small	⅔ x 2 ⅓ in	17 x 60 mm
50-4642	Bookwalter®-Meyerding Retractor Blade, Medium	1 x 3 ⅓ in	25 x 85 mm
50-4643	Bookwalter®-Meyerding Retractor Blade, Large	2 x 3 ¾ in	50 x 95 mm
50-4645	Bookwalter® Rake Retractor-Medium, Rake Retractor, 4 Prong	⅓ x ¾ in	8 ⅔ x 19 mm
50-4646	Bookwalter® Rake Retractor-Large, Rake Retractor, 6 Prong	⅓ x 1 in	8 ⅔ x 25 mm
50-4644	Bookwalter® Rake Retractor-Deep, Rake Retractor, 3 Prong	¾ x ⅔ in	19 x 17 mm
50-4647	Bookwalter® Spinal Retractor, Storage/Sterilizing Case; Depth 4 in (100 mm)	19 ½ x 13 ½ in	500 x 340 mm

Retractor Systems (Bookwalter®)

Bookwalter® Anterior Lumbar Retractor System

CODE	DESCRIPTION	QTY
50-5740	Bookwalter® Anterior Lumbar Spinal Kit Includes the Following:	
50-4688	Bookwalter® Lightweight Table Post, 12 in	1
50-4554	Bookwalter® Table Post Coupling	1
50-4582	Bookwalter® Lightweight Horizontal Flex Bar	1
50-4583	Bookwalter® Segmented Ring, Medium	1
50-4588	Bookwalter® Segmented Ring, Large	1
50-4696	Bookwalter® Self-Retaining RoTilt Ratchet	6
50-5580	Bookwalter® 1x4 Radiolucent Titanium Retractor Blade	2
50-5581	Bookwalter® 1x5 Radiolucent Titanium Retractor Blade	2
50-5587	Bookwalter® 2x6 Radiolucent Titanium Retractor Blade	2
50-5588	Bookwalter® 2x7 Radiolucent Titanium Retractor Blade	2
50-5589	Bookwalter® 2x8 Radiolucent Titanium Retractor Blade	2
67-7504	Bookwalter® 2x11 Opti-Length® Malleable Retractor Blade with Malleable Lip	1

Bookwalter® Vertical Extension Bar

CODE	DIAMETER		LENGTH	
50-4553	1 in	25 mm	12 in	305 mm



Retractors (Cervical)

Caspar Cervical Retractor

CODE	DESCRIPTION
57-5660	Rack and Pinion Ratchet
57-5662	Ring Handle, Self-Retaining



Retractors (Cervical)

Cervical Retractor

Total Opening: 4 ½ in (114 mm)

CODE	DESCRIPTION	LENGTH	
50-1380	Large with Set of 7 Sharp Blades	10 in	245 mm

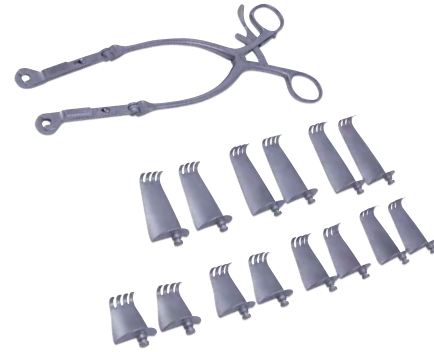

Cervical Retractor Body

CODE	LENGTH
50-1346	10 in 245 mm

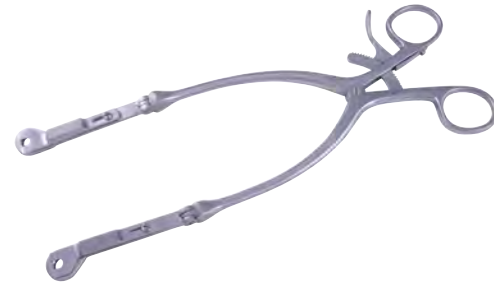

Cervical Retractor Set

CODE	DESCRIPTION	BLADE DEPTH	LENGTH
50-1390	Cervical Retractor Set Small, Self-Retaining with 7 Pairs of Blunt Blades		6 x ¾ in 152 x 95 mm
50-1356	Cervical Retractor Body, Small		
50-1391	Retractor Blade, Blunt	1 in	25 mm
50-1392	Retractor Blade, Blunt	1 ½ in	30 mm
50-1393	Retractor Blade, Blunt	1 ¾ in	35 mm
50-1394	Retractor Blade, Blunt	1 ⅞ in	40 mm
50-1395	Retractor Blade, Blunt	1 ⅞ in	45 mm
50-1396	Retractor Blade, Blunt	2 in	50 mm
50-1397	Retractor Blade, Blunt	2 ½ in	55 mm



50-1391

Cervical Tissue Retractor

CODE	DESCRIPTION	BLADE DEPTH
57-5550	Blunt Prongs	13 mm



Retractors (Cervical)

Cloward Cervical Retractor

CODE	DESCRIPTION
57-5575	With Ratchet



Retractor Systems (Crank Frame Spinal Retractor)



Karlin™ Crank Frame Spinal Retractor Set

CODE	DESCRIPTION	LENGTH
46-3190	Designed for posterior Lumbar and Thoracic spine surgery. Arm design allows the blades to be pre-positioned in the wound prior to attachment. Blades are interchangeable. Multiple blades may be used on each retractor arm. Maximum width opening 5½ in (140 mm) Crank Frame Spinal Retractor Set Includes:	2¼ x 2½ in 57 x 64 mm
46-3191	Crank Frame Retractor Body	
46-3192	Crank Frame Retractor Ratchet	
46-3193	Blade with Sacral Cutout, Left	1¼ x 1½ in 31 x 38 mm
46-3194	Blade with Sacral Cutout, Right	1¼ x 1½ in 31 x 38 mm
46-3195	Blade with Sacral Cutout, Left	2¼ x 1¾ in 57 x 44 mm
46-3196	Blade with Sacral Cutout, Right	3 x 2½ in 57 x 44 mm
46-3197	Blade, Left/Right (2 Blades in Set, 1 with re-order)	1¼ x 1½ in 76 x 64 mm

Retractor Systems (Components)

Crank Frame Retractor Blade

Single Port

CODE	DESCRIPTION	LENGTH	
46-3208	Karlin™ Prong Retractor Blade	1.5 in	38 mm
46-3209	Karlin™ Prong Retractor Blade	2 in	51 mm
46-3210	Karlin™ Prong Retractor Blade	2.5 in	64 mm
46-3211	Karlin™ Prong Retractor Blade	1.5 in	38 mm
46-3212	Karlin™ Prong Retractor Blade	2 in	51 mm
46-3213	Karlin™ Prong Retractor Blade	2.5 in	64 mm



Retractors (Decompression)

Cushing Decompression Retractor

CODE	DESCRIPTION	LENGTH	
57-5205	10 x 18	8 in	200 mm



Retractors (Dural)

90° Dural Suction Retractor

CODE	TIP WIDTH	TIP DEPTH	WORKING DISTANCE	LENGTH
46-3012	$\frac{9}{32}$ in 8 mm	$\frac{1}{4}$ in 6 mm	4 $\frac{3}{4}$ in 120 mm	4 $\frac{3}{4}$ x 4 $\frac{5}{8}$ in 120 x 117 mm



Dural Suction Retractor (Micro)

Black Bayonet

CODE	TIP WIDTH	TIP DEPTH	LENGTH
46-3011	$\frac{1}{4}$ in 6 mm	$\frac{1}{4}$ in 6 mm	8 $\frac{1}{2}$ in 216 mm



Silver Bayonet Dural Suction Retractor

CODE	DESCRIPTION	DEPTH
46-3005	Silver, Bayonet, Macro Tip	$\frac{7}{16}$ in 10 mm



Retractors (Hard Palate)

Crockard™ Hard Palate Retractor

CODE	TIP WIDTH	LENGTH
50-1659	1 in 25 mm	4 ¼ in 108 mm



Retractors (Hemilaminectomy)

Scoville-Haverfiled Hemilaminectomy Retractor

CODE	DESCRIPTION
50-1130	Self-Retaining with Ratchet Action and Hinged Arms, Complete Set



Scoville-Haverfiled Hemilaminectomy Retractor Body

CODE	ARM LENGTH	LENGTH
50-1131	5 ¾ in 146 mm	7 in 178 mm



Scoville Hemilaminectomy Retractor

CODE	DESCRIPTION	SPREAD
50-1125	Self-Retaining	5 in 127 mm



Retractors (Hemilaminectomy)

Valin Hemilaminectomy Retractor

CODE	DESCRIPTION	TOTAL OPENING		LENGTH
50-1120	Self-Retaining with Rack and Pinion Action	4 ½ In	114 mm	



Valin Hemilaminectomy Retractor Body

CODE	DESCRIPTION	LENGTH
50-1121		



Retractors (Laminectomy)

Badgley Laminectomy Retractor

CODE	DESCRIPTION	BLADE WIDTH		BLADE DEPTH		LENGTH
50-1255	Self-Retaining	1 ¾ in	44 mm	2 in	51 mm	6 ¾ in 162 mm



Retractors (Laminectomy)

Beckman-Adson Laminectomy Retractor

Self-Retaining with Hinged Arms

CODE	DESCRIPTION	BLADE WIDTH		BLADE DEPTH		TOTAL OPENING		LENGTH	
50-1160	Four Prong, Blunt	1 in	25 mm	1¼ in	32 mm	5 in	127 mm	12 in	305 mm
50-1161	Four Prong, Sharp	1 in	25 mm	1 in	25 mm	5 in	127 mm	12 in	305 mm
50-1162	Four Prong, X-Long	1 in	25 mm	1¾ in	44 mm	5½ in	140 mm	12 in	305 mm
50-1163	Seven Pronged Blades	1¾ in	44 mm	1⅞ in	48 mm	5½ in	140 mm	12¾ in	324 mm



50-1160

Cone Laminectomy Retractor

Self-Retaining with Hinged Arms

CODE	DESCRIPTION	LENGTH	
50-1167	3 x 4 Sharp Prongs	6⅜ in	162 mm
50-1168	3 x 4 Sharp Prongs	8 in	203 mm



50-1167

Retractors (Laminectomy)

Meyering Laminectomy Retractor

CODE	DESCRIPTION	BLADE WIDTH	BLADE DEPTH	LENGTH
23-6301	#1 Small, $\frac{5}{8}$ x 2 x 9 in			9 $\frac{1}{2}$ in 241 mm
23-6302	#2 Medium, 1 x 3 x 9 $\frac{1}{2}$ in			9 $\frac{1}{2}$ in 241 mm
50-1065	Small	$\frac{5}{8}$ in 16 mm	2 in 51 mm	6 $\frac{1}{2}$ in 165 mm
50-1066	Medium	1 in 25 mm	3 in 76 mm	7 $\frac{7}{8}$ in 180 mm
50-1067	Large	2 in 51 mm	3 $\frac{1}{2}$ in 89 mm	9 in 229 mm
24-4530	25 x 30 mm			6 $\frac{1}{2}$ in 165 mm
50-1192	Self Retaining	1 in 25 mm	1 $\frac{3}{4}$ in 44 mm	
50-1191	Self Retaining	1 in 25 mm	2 in 51 mm	
50-1190	Self Retaining	1 in 25 mm	2 $\frac{1}{4}$ in 57 mm	6 $\frac{1}{2}$ in 165 mm



23-6301

Poppen-Gelpi Laminectomy Retractor

CODE	DESCRIPTION	TOTAL OPENING	LENGTH
50-1212	Self-Retaining	2 $\frac{1}{2}$ in 64 mm	5 $\frac{1}{2}$ in 140 mm



Seletz-Gelpi Laminectomy Retractor

CODE	DESCRIPTION	ARM LENGTH	TOTAL OPENING	LENGTH
50-1211	Self-Retaining with Arms Bent at Right Angles	2 $\frac{9}{16}$ in 65 mm	3 $\frac{3}{4}$ in 95 mm	6 $\frac{1}{4}$ in 159 mm



Retractor Systems (Components)

Taylor Laminectomy Blade

CODE	DESCRIPTION	BLADE WIDTH		BLADE DEPTH	
13-1054	Three Prong	1½ in	38 mm	1¾ in	45 mm
13-1055	Four Prong	2 in	51 mm	1⅞ in	48 mm
13-1056	Four Prong	2¼ in	57 mm	2½ in	64 mm
13-1057	Four Prong	2¼ in	57 mm	3⅞ in	79 mm



13-1054

Retractors (Lumbar)

Lumbar Retractor Body

CODE	DESCRIPTION	TOTAL OPENING		LENGTH	
50-1249	Self-Retaining	5 in	127 mm	9 in	229 mm

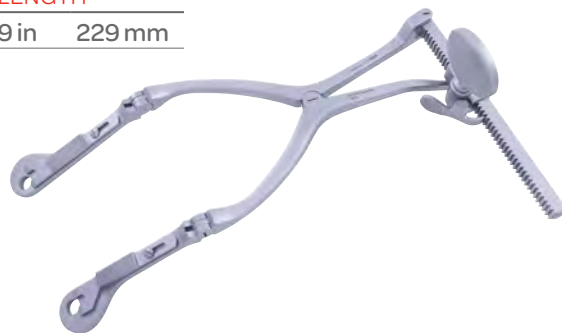

Scoville Ultra™ Reveal Lumbar Retractor Body

CODE	DESCRIPTION	SPREAD
59-1104	Double Hinge	8 in 200 mm



Retractors (McCulloch)



57-5721

McCulloch Hinged Retractor

Black Finish Blades are for Use with Black Finish Frames

CODE	DESCRIPTION
57-5721	Frame Only, Black Finish
57-5721T	Frame Only, Titanium



57-5720

McCulloch Rigid Retractor

Frame Only

CODE	DESCRIPTION	LENGTH
57-5720	Black blades Must be Used with the Black Frame	50 mm
57-5720T	Titanium	60 mm

Retractors (McCulloch)



57-5739

McCulloch Hook Blade

CODE	BLADE WIDTH	HOOK DEPTH	
57-5738	Black Finish	3/4 in	20 mm
57-5739	Black Finish	1 1/8 in	30 mm
57-5740 mm	Black Finish	1 1/2 in	40 mm
57-5741	Black Finish	1 7/8 in	50 mm
57-5742	Black Finish	2 3/8 in	60 mm
57-5743	Black Finish	2 3/4 in	70 mm
57-5751	Black Finish	3 1/8 in	80 mm



57-5739T

McCulloch Hook Blade

CODE	DESCRIPTION	HOOK DEPTH	
57-5739T	Titanium	1 1/8 in	30 mm
57-5740T	Titanium	1 1/2 in	40 mm
57-5741T	Titanium	1 7/8 in	50 mm
57-5742T	Titanium	2 3/8 in	60 mm
57-5743T	Titanium	2 3/4 in	70 mm
57-5750T	Titanium	3 1/8 in	80 mm

Retractors (McCulloch)



McCulloch Multi-Hooked Blade

Sold Individually

57-5746

CODE	DESCRIPTION	HOOK DEPTH	
57-5744	Black Finish	$\frac{3}{4}$ in	20 mm
57-5745	Black Finish	$1\frac{1}{8}$ in	30 mm
57-5746	Black Finish	$1\frac{1}{2}$ in	40 mm
57-5747	Black Finish	$1\frac{7}{8}$ in	50 mm
57-5748	Black Finish	$2\frac{3}{8}$ in	60 mm
57-5749	Black Finish	$2\frac{3}{4}$ in	70 mm
57-5753	Black Finish	$3\frac{1}{8}$ in	80 mm
57-5752	Black Finish	$3\frac{1}{2}$ in	90 mm



57-5745T

McCulloch Multi-Hooked Blade

CODE	DESCRIPTION	HOOK DEPTH	
57-5744T	Titanium	$\frac{3}{4}$ in	20 mm
57-5745T	Titanium	$1\frac{1}{8}$ in	30 mm
57-5746T	Titanium	$1\frac{1}{2}$ in	40 mm
57-5747T	Titanium	$1\frac{7}{8}$ in	50 mm
57-5748T	Titanium	$2\frac{3}{8}$ in	60 mm
57-5749T	Titanium	$2\frac{3}{4}$ in	70 mm



57-5793

McCulloch Thin Muscle Blade

Sold individually

CODE	DESCRIPTION	BLADE W X D	
57-5793	Black Finish	$\frac{1}{16}$ x $1\frac{1}{2}$ in	17 x 40 mm
57-5794	Black Finish	$\frac{1}{16}$ x $1\frac{7}{8}$ in	17 x 50 mm
57-5795	Black Finish	$\frac{1}{16}$ x $1\frac{3}{8}$ in	17 x 60 mm
57-5796	Black Finish	$\frac{1}{16}$ x $2\frac{3}{4}$ in	17 x 70 mm

Retractors (McCulloch)



57-5732

McCulloch Narrow Muscle Retractor Blade

1 Pair

CODE	DESCRIPTION	HOOK DEPTH	
57-5732	Black Finish	$\frac{3}{4}$ in	30 mm
57-5733	Black Finish	$1\frac{1}{8}$ in	40 mm
57-5734	Black Finish	$1\frac{1}{2}$ in	50 mm
57-5735	Black Finish	$1\frac{7}{8}$ in	60 mm
57-5736	Black Finish	$2\frac{3}{8}$ in	70 mm
57-5737	Black Finish	$2\frac{3}{4}$ in	80 mm
57-5772	Black Finish	$3\frac{1}{8}$ in	90 mm
57-5773	Black Finish	$3\frac{1}{2}$ in	100 mm
57-5774	Black Finish	$4\frac{1}{4}$ in	110 mm
57-5775	Black Finish	$4\frac{5}{8}$ in	120 mm



57-5781T

McCulloch Narrow Muscle Retractor Blade

1 Pair

CODE	DESCRIPTION	HOOK DEPTH	
57-5732T	Titanium	$\frac{3}{4}$ in	30 mm
57-5733T	Titanium	$1\frac{1}{8}$ in	40 mm
57-5734T	Titanium	$1\frac{1}{2}$ in	50 mm
57-5735T	Titanium	$1\frac{7}{8}$ in	60 mm
57-5736T	Titanium	$2\frac{3}{8}$ in	70 mm
57-5737T	Titanium	$2\frac{3}{4}$ in	80 mm
57-5781T	Titanium	$3\frac{1}{8}$ in	90 mm

Retractors (McCulloch)



57-5790

McCulloch Single Cervical Blade

CODE	DESCRIPTION
57-5790-40	2 Teeth, 40 mm
57-5790	2 Teeth, 50 mm
57-5791	2 Teeth, 60 mm
57-5792	2 Teeth, 70 mm



57-5726

McCulloch Wide Muscle Retractor Blade

2.7 mm Wide

CODE	DESCRIPTION	BLADE DEPTH	
57-5726	Black Finish	$\frac{3}{4}$ in	30 mm
57-5727	Black Finish	$1\frac{1}{8}$ in	40 mm
57-5728	Black Finish	$1\frac{1}{2}$ in	50 mm
57-5729	Black Finish	$1\frac{7}{8}$ in	60 mm
57-5730	Black Finish	$2\frac{3}{8}$ in	70 mm
57-5731	Black Finish	$2\frac{3}{4}$ in	80 mm
57-5783	Black Finish	$3\frac{1}{8}$ in	90 mm
57-5784	Black Finish	$3\frac{1}{2}$ in	100 mm
57-5785	Black Finish	$4\frac{1}{4}$ in	110 mm
57-5786	Black Finish	$4\frac{5}{8}$ in	120 mm

Retractors (McCulloch)



57-5730T

McCulloch Wide Muscle Retractor Blade

1 Pair

CODE	DESCRIPTION	BLADE DEPTH	
57-5726T	Titanium	$\frac{3}{4}$ in	30 mm
57-5727T	Titanium	$1\frac{1}{8}$ in	40 mm
57-5728T	Titanium	$1\frac{1}{2}$ in	50 mm
57-5729T	Titanium	$1\frac{7}{8}$ in	60 mm
57-5730T	Titanium	$2\frac{3}{8}$ in	70 mm
57-5731T	Titanium	$2\frac{3}{4}$ in	80 mm
57-5783T	Titanium	$3\frac{1}{8}$ in	90 mm

Retractors (Medial)



57-5665

Cervical Retractor Blade

Stainless Steel, Ball Snap Closure, for use with 57-5759, 57-5760, 57-5761 and 57-5762

CODE	DESCRIPTION
57-5665	Medial Blades with Teeth 40 x 23 mm
57-5666	Medial Blades with Teeth 45 x 23 mm
57-5667	Medial Blades with Teeth 50 x 23 mm
57-5668	Medial Blades with Teeth 55 x 23 mm
57-5669	Medial Blades with Teeth 60 x 23 mm
57-5665L	Lateral Blades with Teeth 40 x 23 mm
57-5666L	Lateral Blades with Teeth 45 x 23 mm
57-5667L	Lateral Blades with Teeth 50 x 23 mm
57-5668L	Lateral Blades with Teeth 55 x 23 mm
57-5669L	Lateral Blades with Teeth 60 x 23 mm

Retractors (Micro)



59-0080

Ultra™ ReVeal ACF Blades

CODE	DESCRIPTION	COLOR	LENGTH	QTY
59-0080	ACF Micro Blade, Blunt	Blue	$\frac{9}{16} \times 1 \frac{3}{8}$ in 14 x 35 mm	2
59-0081	ACF Micro Blade, Blunt	Red	$\frac{9}{16} \times 1 \frac{5}{8}$ in 14 x 40 mm	2

Retractors (Micro Discectomy)

Williams Micro Discectomy Retractor

CODE	BLADE WIDTH	BLADE LENGTH	LENGTH
80-1650	10 mm	50 mm	6 in 152 mm
80-1651	20 mm	50 mm	6 in 152 mm
80-1652	10 mm	70 mm	6 in 152 mm
80-1653	20 mm	70 mm	6 in 152 mm



80-1650

Retractors

Williams Microlumbar Discectomy Suction Retractor

CODE	DESCRIPTION	LENGTH
80-1655	16 French	6 in 152 mm



Retractor Systems (Components)

Crockard™ Mid-Facial Osteotomy Retractor Plate

CODE	DESCRIPTION	WIDTH	OPENING	WIDTH	LENGTH
50-1668		1 3/4 in	44 mm	2 in	50 mm
					2 1/2 in 64 mm



Retractors (Nerve Root)

Campbell Nerve Root Retractor

CODE	DESCRIPTION	BLADE WIDTH	LENGTH
50-1326	Malleable Shaft	3/8 in 10 mm	8 1/2 in 216 mm



D'errico Nerve Root Retractor

CODE	DESCRIPTION	BLADE WIDTH	LENGTH
50-1270		1/4 in 6 mm	9 in 229 mm



Holsher Nerve Root Retractor

CODE	DESCRIPTION	BLADE WIDTH	LENGTH
50-1331		5/16 x 9 3/4 in	7 x 248 mm



Love Nerve Root Retractor

CODE	DESCRIPTION	BLADE WIDTH	SHAFT LENGTH	LENGTH
50-1315	Straight	1/4 in 6 mm	4 in 102 mm	7 5/8 in 194 mm
50-1316	90° Angle	1/4 in 6 mm	4 in 102 mm	3 3/4 in 95 mm
50-1317	135° Angle	1/4 in 6 mm	4 in 102 mm	3 1/4 in 83 mm



50-1315

Retractors (Nerve Root)

McCulloch Nerve Root Retractor

CODE	WIDTH	LENGTH
57-5761	6 mm	5 in 127 mm
57-5762	6 mm	5 in 127 mm



57-5762

Scoville Nerve Root Retractor

CODE	DESCRIPTION	BLADE WIDTH	LENGTH
50-1291	90°	$\frac{5}{16}$ in 8 mm	4 $\frac{1}{4}$ x 5 in 108 x 127 mm
50-1293	90°	$\frac{1}{2}$ in 13 mm	4 $\frac{1}{4}$ x 5 in 108 x 127 mm



Smith Nerve Root Suction Retractor

With Obturator and Thumb Control For Suction

CODE	DESCRIPTION	TIP WIDTH	TIP DEPTH	SHAFT LENGTH	LENGTH
50-1275		$\frac{1}{4}$ in 6 mm	$\frac{1}{8}$ in 3 mm	5 $\frac{1}{4}$ in 133 mm	7 in 178 mm



Weary Nerve Root Retractor

CODE	BLADE WIDTH	SHAFT LENGTH	HANDLE LENGTH
50-1310	$\frac{7}{16}$ in 11 mm	5 $\frac{3}{4}$ in 146 mm	5 $\frac{3}{4}$ in 146 mm



Retractors

Crockard™ Pharyngeal Retractor

CODE	DESCRIPTION	LENGTH
50-1660	Small	7 in 178 mm
50-1661	Large	7½ in 191 mm



50-1660

Retractors (Radiolucent)

Caspar Medial Radiolucent Carbon Fiber Blade

Carbon Fiber Radiolucent Blades, Ball Snap Closure, for Use with Cervical Retractors: 57-5659, 57-5660, 57-5661 and 57-5662.



57-5510B

CODE	DESCRIPTION
57-5510	40 x 23 mm
57-5511	45 x 23 mm
57-5512	50 x 23 mm
57-5513	55 x 23 mm
57-5514	60 x 23 mm
57-5515	65 x 23 mm



57-5523

Cervical Retractor Blades, Longitudinal Blades, Blunt

Carbon Fiber Radiolucent Blades, Ball Snap Closure

CODE	DESCRIPTION
57-5522	40 x 23 mm
57-5523	45 x 23 mm
57-5524	50 x 23 mm
57-5525	55 x 23 mm
57-5526	60 x 23 mm
57-5527	65 x 23 mm

Retractors (Sacral)

Blade with Sacral Cutout

CODE	DESCRIPTION	LENGTH	
46-3193	Left	1¼ x 1½ in	31 x 38 mm
46-3195	Left	2¼ x 1¾ in	57 x 44 mm
46-3194	Right	1¼ x 1½ in	31 x 38 mm
46-3196	Right	2¼ x 1¾ in	57 x 44 mm

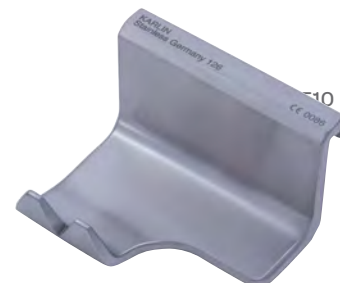

46-3193

Retractors (Self-Retaining)

Adson 4 x 4 Retractor

Total Opening 4 ½ in (114 mm)

CODE	DESCRIPTION	BLADE SIZE	LENGTH
50-1180	Straight Shaft, Sharp Prongs	5⁄8 x 7⁄8 in 16 x 22 mm	7 ½ in 178 mm
50-1182	Straight Shaft, Blunt Prongs	5⁄8 x 7⁄8 in 16 x 22 mm	7 ½ in 178 mm
50-1181	Angular Shaft, Sharp Prongs	5⁄8 x 7⁄8 in 16 x 22 mm	7 ½ in 178 mm

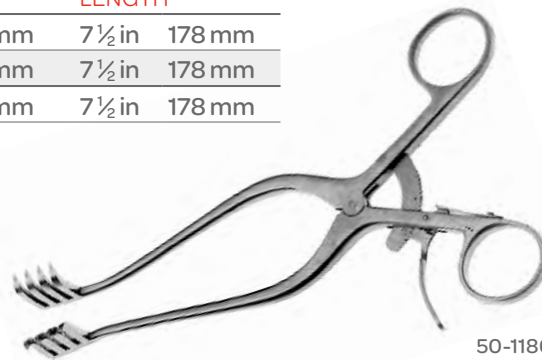

50-1180

Adson Retractor

Shank Angle 65°

CODE	DESCRIPTION	LENGTH
50-1362	3 x 3 Sharp Prongs	9 ½ in 240 mm



Retractors (Self-Retaining)

Weitlaner Retractor

Sharp

CODE	DESCRIPTION	LENGTH	
24-2210	2 x 3	4 ½ in	115 mm
24-2213	3 x 4	5 ½ in	140 mm
24-2216	3 x 4	6 ½ in	165 mm
24-2220	3 x 4	8 in	200 mm
24-2224	3 x 4	9 in	230 mm



24-2210

Weitlaner Retractor

Blunt

CODE	DESCRIPTION	LENGTH	
24-2211	2 x 3	4 ½ in	115 mm
24-2214	3 x 4	5 ½ in	140 mm
24-2217	3 x 4	6 ½ in	165 mm
24-2221	3 x 4	8 in	200 mm



24-2211

Retractors



50-1085

Taylor Spinal Retractor

CODE	DESCRIPTION	BLADE WIDTH		BLADE DEPTH		LENGTH	
50-1085	Small	1 ⅜ in	30 mm	3 in	76 mm	7 ¼ in	185 mm
50-1086	Large	1 ¼ in	32 mm	4 in	102 mm	7 ¼ in	185 mm

Retractors (Sternal)

Himmelstein Sternal Retractor

Self-Retaining with Ratchet Action and Flexible Arms

CODE	DESCRIPTION	BLADE WIDTH	ARM LENGTH	BLADE DEPTH	TOTAL OPENING
50-1133		1 $\frac{3}{8}$ in 35 mm	5 $\frac{1}{4}$ in 133 mm	1 $\frac{1}{8}$ in 29 mm	5 in 127 mm



Retractors (Tongue)

Crockard™ Tongue Retractor Blade

CODE	DESCRIPTION	BLADE LENGTH	LENGTH
50-1653	Small	3 in 76 mm	6 in 152 mm
50-1652	Large	3 $\frac{1}{2}$ in 91 mm	6 in 152 mm



50-1653

Crockard™ Transoral Retractor Body

CODE
50-1651



Rongeurs (Bone)

Adson Cranial Rongeur

Straight

CODE	DESCRIPTION	LENGTH
53-1040	8 mm	8 in 203 mm



Bacon Cranial Rongeur

Angular

CODE	BITE	LENGTH
53-1035	$\frac{3}{16}$ in 5 mm	7 $\frac{3}{4}$ in 197 mm



Beyer Rongeur

CODE	DESCRIPTION	LENGTH
53-1100	Curved, Double Action	7 in 178 mm

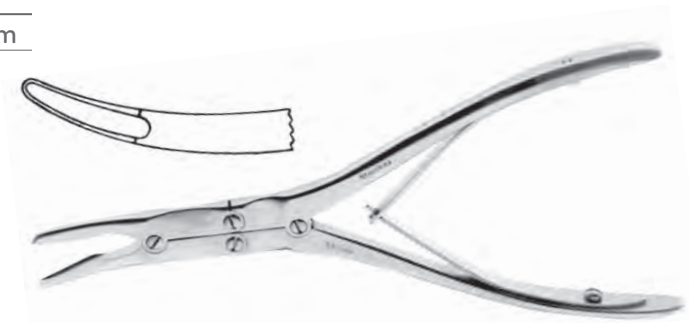

Cottle Jansen Rongeur

Angled

CODE	DESCRIPTION	LENGTH
30-5312	12 x 5 mm Jaws	6 $\frac{3}{4}$ in 170 mm

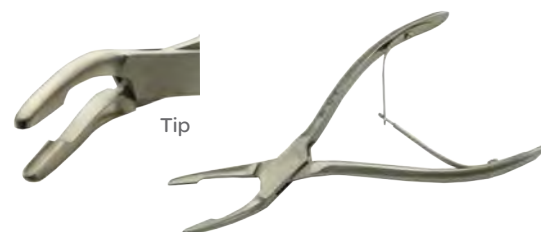

Rongeurs (Bone)

Echlin Duckbill Rongeur

Angled

CODE	DESCRIPTION	LENGTH
31-6102	2 x 10 mm Jaws	9 in 230 mm



Friedman Rongeur

CODE	DESCRIPTION	LENGTH
30-0203	Straight, 2 mm Jaws	6 in 150 mm
30-0514	Curved, 2.5 mm Jaws	5 1/2 in 140 mm
30-0516	Curved, 4 x 11 mm	5 1/2 in 140 mm
30-0204	Curved, 2 mm Jaws	6 in 150 mm



30-0514

Friedman Micro Rongeur

1.5 mm Jaw, Very Delicate

CODE	DESCRIPTION	LENGTH
30-0201	Straight	5 1/2 in 140 mm
30-0202	Curved	5 1/2 in 140 mm



30-0202

Fulton Laminectomy Rongeur

Double Action, Cup Size 15 x 16 mm, Narrow Blade

CODE	DESCRIPTION	LENGTH
53-1060	Straight	7 1/2 in 191 mm
53-1066	Straight	9 1/2 in 241 mm
53-1061	Slightly Curved	7 1/2 in 191 mm
53-1067	Slightly Curved	9 1/2 in 241 mm



53-1060

Rongeurs (Bone)

Kerrison Laminectomy Rongeur

40° Up

CODE	DESCRIPTION	LENGTH
53-1385	3 mm	6 in 152 mm
53-1386	5 mm	6 in 152 mm
53-1387	3 mm	7½ in 191 mm
53-1388	5 mm	7½ in 191 mm



53-1386

Kerrison Laminectomy Rongeur

Up Biting Shaft

CODE	DESCRIPTION	LENGTH
53-1370	3 mm	6 in 152 mm
53-1371	5 mm	6 in 152 mm
53-1372	3 mm	7½ in 191 mm
53-1373	5 mm	7½ in 191 mm



53-1370

Leksell Rongeur

Slight Curve Handle

CODE	DESCRIPTION	LENGTH
31-5105	5 mm	9 in 230 mm
31-5108	8 mm	9 in 230 mm



31-5105

Lempert Rongeur

CODE	DESCRIPTION	LENGTH
30-7619	2.5 mm Wide, Straight Jaws	7½ in 190 mm

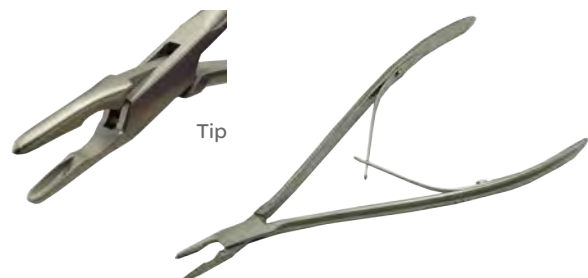

Rongeurs (Bone)

Lempert Rongeur

Bite $\frac{1}{16}$ in (2 mm)

CODE	DESCRIPTION	LENGTH
53-1108	Straight	6 $\frac{1}{8}$ in 156 mm
53-1102	Curved	6 $\frac{1}{8}$ in 156 mm



Lempert Rongeur

Slender Pattern, 2.5 mm Jaws

CODE	DESCRIPTION	LENGTH
30-7620	Straight	6 $\frac{1}{4}$ in 160 mm
30-7622	Curved	6 $\frac{1}{4}$ in 160 mm



Tip
30-7622



30-7620

Lempert Rongeur

Slender Pattern, 2.5 mm Jaws

CODE	DESCRIPTION	LENGTH
30-7623	Straight	7 $\frac{1}{2}$ in 190 mm
30-7624	Curved	7 $\frac{1}{2}$ in 190 mm
30-7625	Curved	7 $\frac{1}{2}$ in 190 mm



Luer Bone Rongeur

Bite $\frac{1}{4}$ in (6 mm)

CODE	DESCRIPTION	LENGTH
30-5217	Straight	7 $\frac{1}{8}$ in 180 mm
53-1011	Curved	7 in 178 mm



30-5217

Rongeurs (Bone)

Opti-Length® LUER Laminectomy

Double Action

CODE	DESCRIPTION	LENGTH
67-7906	Curved, 1 mm	14 in 356 mm
67-7907	Curved, 2 mm	14 in 356 mm
67-7908	Curved, 3 mm	14 in 356 mm
67-7909	Curved, 4 mm	14 in 356 mm
67-7910	Curved, 5 mm	14 in 356 mm
67-7911	Curved, 6 mm	14 in 356 mm
67-7918	Full Curve, 1 mm	14 in 356 mm
67-7919	Full Curve, 2 mm	14 in 356 mm
67-7920	Full Curve, 3 mm	14 in 356 mm
67-7921	Full Curve, 4 mm	14 in 356 mm
67-7922	Full Curve, 5 mm	14 in 356 mm
67-7923	Full Curve, 6 mm	14 in 356 mm



Reiner Rongeur

Curved

CODE	BITE	LENGTH
53-1015	3 x 13 mm	7 in 178 mm
53-1016	4 x 14 mm	7 in 178 mm



53-1015

Ruskin Rongeur

Double Action

CODE	DESCRIPTION	BITE	LENGTH
53-1310	Straight	4 x 33 mm	7¼ in 185 mm
53-1312	Straight	5 x 33 mm	7¼ in 185 mm
53-1311	Curved	4 x 33 mm	7¼ in 185 mm
53-1313	Curved	5 x 33 mm	7¼ in 185 mm



Rongeurs (Bone)

Semb Stille Rongeur

CODE	DESCRIPTION	LENGTH
31-3153	Curved	9 in 230 mm



53-1310

Smith-Peterson Laminectomy Rongeur

Double Action

CODE	DESCRIPTION	LENGTH
53-1080	Straight, 4 x 15 mm	7½ in 191 mm
53-1083	Straight	9½ in 241 mm
53-1081	Slightly Curved, 4 x 15 mm	7½ in 191 mm
53-1084	Slightly Curved	9½ in 241 mm
53-1085	Full Curve	9½ in 241 mm



53-1080

Stille-Luer Rongeur

CODE	DESCRIPTION	JAW	LENGTH
53-1130	Straight	10 mm	8½ in 216 mm
53-1131	Curved	10 mm	8½ in 216 mm
31-3183	Duckbill Angled	7 mm	9 in 230 mm
31-3193	Angled	5 mm	9 in 230 mm
53-1118	Angular, Flat Lower Jaw	5 mm	9½ in 241 mm
53-1133	Angular	5 mm	9½ in 241 mm
67-7239	Angled Jaw	5 mm	11 in 280mm
67-7241	Angled Jaw	5 mm	13 in 330mm
67-7240	Straight Jaw	10 mm	11 in 280mm
67-7242	Straight Jaw	10 mm	13 in 330mm



53-1130

Rongeurs (Bone)

Stille-Luer Bone Rongeur

CODE	DESCRIPTION	LENGTH
31-3027	Straight, 17 mm	10 ½ in 265 mm
31-3123	Curved, 10 mm	9 in 230 mm
31-3121	Curved, 10 mm	10 ½ in 265 mm



31-3123

Zaufal-Jansen Rongeur

Curved, Double Action

CODE	DESCRIPTION	LENGTH
53-1095	4 x 30 mm	6 ¾ in 171 mm



Rongeurs (Bone, Synovectomy)

Kleinert Kutz Synovectomy Rongeur

2 mm Jaws

CODE	DESCRIPTION	LENGTH
30-7613	Slightly Curved	5 ½ in 140 mm
30-7614	Fully Curved	5 ½ in 140 mm



30-7614

Synovectomy Forceps with Rongeur

2 mm Jaw

CODE	DESCRIPTION	LENGTH
30-7617	Ring Handle	5 in 125 mm

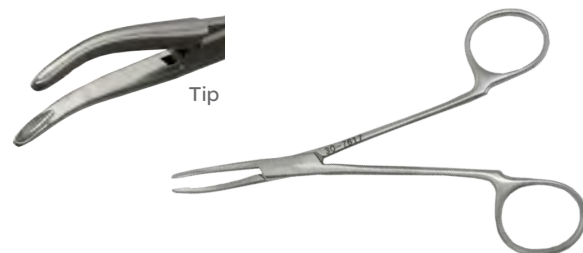

Rongeurs (Intervertebral Disc)

Caspar Rongeur

CODE	DESCRIPTION	LENGTH
57-2920-1	Angled Down, 2 x 12 mm	7¼ in 185 mm
57-2908	Angled Down, 5 x 14 mm	7½ in 190 mm
57-2905	Angled Up, 3 x 12 mm	7½ in 190 mm
57-2906	Angled Up, 4 x 14 mm	7½ in 190 mm
57-2910	Angled Up, 2 x 12 mm	7¼ in 185 mm

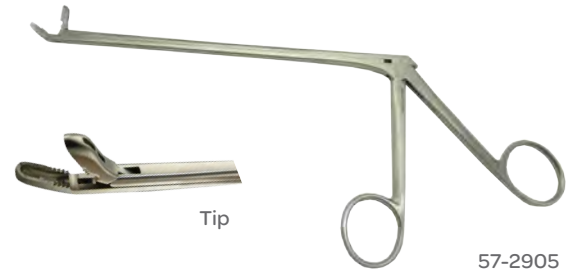

Caspar Rongeur

CODE	DESCRIPTION	LENGTH
57-2946	Down, 3 mm	6 in 150 mm
57-2921	Angled Down, 4 x 14 mm	6¼ in 160 mm
57-2919	Angled Up, 5 x 14 mm	6¼ in 160 mm



Caspar Rongeur

Angled Up

CODE	DESCRIPTION	LENGTH
57-2910-11	2 x 12 mm	11 in 280 mm
57-2905-11	3 x 12 mm	11 in 280 mm

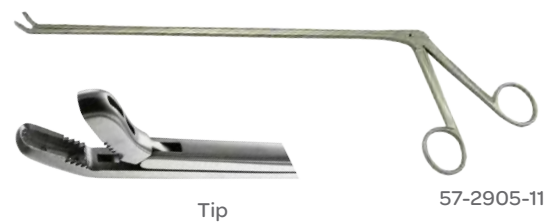

Caspar Rongeur

Ceramic Coated

CODE	DESCRIPTION	LENGTH
57-2901-BD	Straight, 2 x 12 mm	7¼ in 185 mm
57-2903-BD	Straight, 4 x 14 mm	7¼ in 185 mm
57-2922-BD	Straight, 2 x 12 mm	9 in 230 mm
57-2930-BD	Down, 2 x 12 mm	9 in 230 mm



Rongeurs (Intervertebral Disc)

Caspar Rongeur

Straight

CODE	DESCRIPTION	LENGTH
57-2901-11	2 x 12 mm	11 in 280 mm
57-2902-11	3 x 12 mm	11 in 280 mm

Caspar IVD Rongeur

Straight

CODE	DESCRIPTION	LENGTH
57-2912	2 x 12 mm	6 ¼ in 160 mm
57-2913	3 x 12 mm	6 ¼ in 160 mm
57-2915	5 x 12 mm	6 ¼ in 160 mm



Caspar IVD Rongeur

Straight

CODE	DESCRIPTION	LENGTH
57-2901	2 x 12 mm	7 ¼ in 185 mm
57-2902	3 x 12 mm	7 ¼ in 185 mm
57-2903	4 x 12 mm	7 ¼ in 185 mm
57-2904	5 x 12 mm	7 ¼ in 185 mm



Cloward Opti-Length® Rongeur

CODE	DESCRIPTION	LENGTH
67-7324	6 x 10 mm Cup	11 in 279 mm



Cushing Rongeur

1.5 x 10 mm

CODE	DESCRIPTION	LENGTH
57-2001	Straight	7 in 178 mm
57-1998	Straight, 1.5 mm	9 in 230 mm
57-1999	Down, 1.5 mm	7 in 178 mm
57-2000	Up, 1.5 mm	7 in 178 mm
57-1997	Up, 1.5 mm	9 in 230 mm

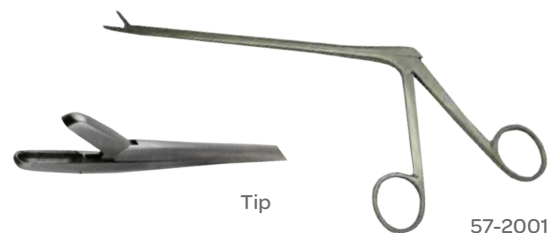

Rongeurs (Intervertebral Disc)

Cushing Intervertebral Disc Rongeur

Straight

CODE	DESCRIPTION	LENGTH	
53-1290	Cup Shaped Jaws, 2x10 mm Cup	5 in	127 mm
53-1195	Cup Shaped Jaws, 2x10 mm Cup	6 in	152 mm
53-1230	Cup Shaped Jaws, 2x10 mm Cup	7 in	178 mm
57-2012	2x10 mm	6 in	155 mm
57-2022	2x10 mm	7 in	175 mm
57-2060	2x10 mm	9 in	230 mm
57-2023	2x10 mm	10 in	250 mm
57-2036	2x10 mm	12 in	305 mm
57-2122	2x10 mm Jaws, with Teeth	7 in	178 mm



53-1290

Cushing Intervertebral Disc Rongeur

Curved Down

CODE	DESCRIPTION	LENGTH	
53-1292	Cup Shaped Jaws, 2x10 mm Cup	5 in	127 mm
53-1197	Cup Shaped Jaws, 2x10 mm Cup	6 in	152 mm
53-1233	Cup Shaped Jaws, 2x10 mm Cup	7 in	178 mm



53-1197

Cushing Intervertebral Disc Rongeur

Curved Up

CODE	DESCRIPTION	LENGTH	
53-1291	Cup Shaped Jaws, 2x10 mm Cup	5 in	127 mm
53-1196	Cup Shaped Jaws, 2x10 mm Cup	6 in	152 mm
53-1232	Cup Shaped Jaws, 2x10 mm Cup	7 in	178 mm



53-1196

Rongeurs (Intervertebral Disc)

Cushing Intervertebral Disc Rongeur

Angled Down

CODE	DESCRIPTION	LENGTH
57-2062	2 x 10 mm	5 in 125 mm
57-2082	2 x 10 mm	7 in 178 mm
57-2065	2 x 10 mm	9 in 230 mm
57-2182	2 x 10 mm Jaws, with Teeth	7 in 178 mm



Cushing Intervertebral Disc Rongeur

Angled Up

CODE	DESCRIPTION	LENGTH
57-2042	2 x 10 mm	6 in 150 mm
57-2052	2 x 10 mm	7 in 178 mm
57-2063	2 x 10 mm	9 in 230 mm
57-2033	2 x 10 mm	11 in 280 mm
57-2152	2 x 10 mm Jaws, with Teeth	7 in 178 mm



Decker Rongeur

1.5 x 5 mm Cups

CODE	DESCRIPTION	LENGTH
57-2098	Straight	5 ½ in 140 mm
57-2099	Angled Down	5 ½ in 140 mm
57-2097	Angled Up	5 ½ in 140 mm

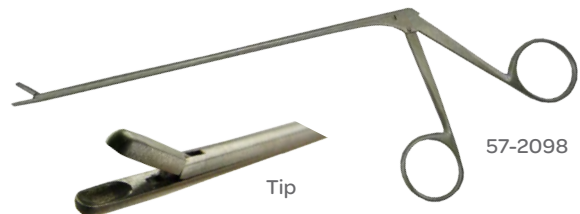

Delicate Intervertebral Disc Rongeur

CODE	DESCRIPTION	LENGTH
53-1250	Straight, Cup 3 x 10 mm	6 in 152 mm
67-7319	Straight, 3 x 10 mm	11 in 280 mm
67-7321	Straight, 4 x 10 mm	11 in 280 mm
53-1252	Curved Down, Cup 3 x 10 mm	6 in 152 mm
53-1251	Curved Up, Cup 3 x 10 mm	6 in 152 mm
67-7320	30 Degree Up Bite, 3 x 10 mm	11 in 280 mm
67-7322	30 Degree Up Bite, 4 x 10 mm	11 in 280 mm



Rongeurs (Intervertebral Disc)

Ferris-Smith Intervertebral Disc Rongeur

Straight

CODE	DESCRIPTION	LENGTH
53-1159	Cup 2 x 10 mm	7 in 178 mm
53-1162	Cup 3 x 10 mm	7 in 178 mm
53-1165	Cup 4 x 10 mm	7 in 178 mm
67-7323	Cup 3 x 10 mm	11 in 280 mm
67-7324	Cup 6 x 10 mm	11 in 280 mm



53-1159

Ferris-Smith Intervertebral Disc Rongeur

Down

CODE	DESCRIPTION	LENGTH
57-1420	2 x 10 mm	7 in 178 mm

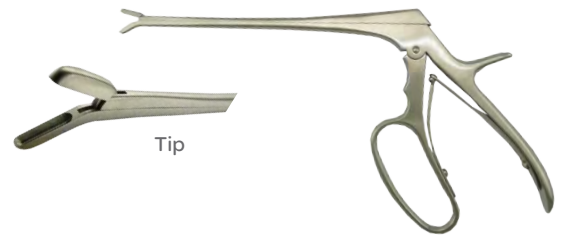

Tip

Ferris-Smith Intervertebral Disc Rongeur

Up

CODE	DESCRIPTION	LENGTH
57-1320	2 x 10 mm	7 in 178 mm
57-1340	4 x 10 mm	7 in 178 mm



Tip

57-1320

Ferris-Smith Intervertebral Disc Rongeur

Curved Down

CODE	DESCRIPTION	LENGTH
53-1161	Cup 2 x 10 mm	7 in 178 mm
53-1164	Cup 3 x 10 mm	7 in 178 mm
53-1167	Cup 4 x 10 mm	7 in 178 mm

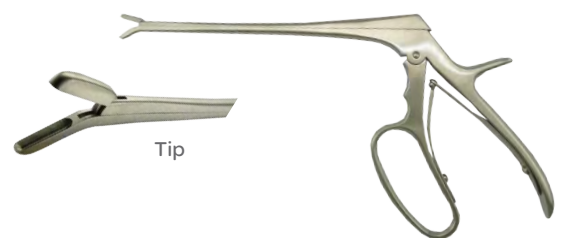

Tip

Ferris-Smith Intervertebral Disc Rongeur

Curved Up

CODE	DESCRIPTION	LENGTH
53-1160	Cup 2 x 10 mm	7 in 178 mm
53-1163	Cup 3 x 10 mm	7 in 178 mm
53-1166	Cup 4 x 10 mm	7 in 178 mm

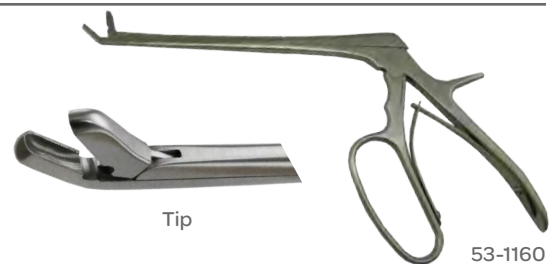

Tip

53-1160

Rongeurs (Intervertebral Disc)

Hoehn Intervertebral Disc Rongeur

Fenestrated

CODE	DESCRIPTION	LENGTH
57-2095	Straight, 4 mm Jaw, 1x2 Teeth	5½ in 140 mm
53-1224	Fenestrated Jaws, Cup 4 x 12 mm	5½ in 140 mm



53-1224

Intervertebral Disc Rongeur

6 x 10 mm Cup

CODE	DESCRIPTION	LENGTH
53-1221	Straight	6 in 152 mm
53-1223	Curved Down	6 in 152 mm
53-1222	Curved Up	6 in 152 mm



53-1221

Intervertebral Disc Rongeur

CODE	CUP SIZE	LENGTH
53-1171	4 x 8 mm	7 in 178 mm
53-1220	6 x 10 mm	7 in 178 mm
53-1225	6 x 12 mm	7 in 178 mm



53-1171

Love-Gruenwald Intervertebral Disc Rongeur

Curved Up

CODE	DESCRIPTION	LENGTH
53-1296	Cup Shaped Jaw, 3x10 mm	5 in 127 mm
53-1201	Cup Shaped Jaw, 3x10 mm	6 in 152 mm
53-1236	Cup Shaped Jaw, 3x10 mm	7 in 178 mm



57-1296

Rongeurs (Intervertebral Disc)

Love-Gruenwald Intervertebral Disc Rongeur

Straight

CODE	DESCRIPTION	LENGTH	
53-1295	Cup Shaped Jaw, 3x10 mm	5 in	127 mm
53-1200	Cup Shaped Jaw, 3x10 mm	6 in	152 mm
53-1235	Cup Shaped Jaw, 3x10 mm	7 in	178 mm
57-2103	3x10 mm	5 in	127 mm
57-2123	3x10 mm	7 in	178 mm
57-2070	3x10 mm	9 in	230 mm
57-2040	3x10 mm	11 in	280 mm
57-2076	3x10 mm	12 in	305 mm
57-2066	3x10 mm, with Teeth	7 in	178 mm



57-2103

Love-Gruenwald Intervertebral Disc Rongeur

Curved Down

CODE	DESCRIPTION	LENGTH	
53-1297	Cup Shaped Jaw, 3x10 mm	5 in	127 mm
53-1202C	Cup Shaped Jaw, 3x10 mm	6 in	152 mm
53-1237	Cup Shaped Jaw, 3x10 mm	7 in	178 mm



57-1297

Love-Gruenwald Intervertebral Disc Rongeur

Angled Up

CODE	DESCRIPTION	LENGTH	
57-2133	3x10 mm	5 in	125 mm
57-2153	3x10 mm	7 in	175 mm
57-2073	3x10 mm	9 in	230 mm
57-2043	3x10 mm	11 in	280 mm



57-2133

Rongeurs (Intervertebral Disc)

Love-Gruenwald Intervertebral Disc Rongeur

Angled Down

CODE	DESCRIPTION	LENGTH	
57-2163	3 x 10 mm	5 in	125 mm
57-2075	3 x 10 mm	9 in	230 mm



Love-Gruenwald Intervertebral Disc Rongeur

Angled Up

CODE	DESCRIPTION	LENGTH	
57-2013	3 x 10 mm	6 in	150 mm



Love-Gruenwald Opti-Length® Rongeur, IVD

3 x 10 Cup

CODE	DESCRIPTION	LENGTH	
67-7319	Straight	11 in	279 mm
67-7320	30° Up	11 in	279 mm



Oldberg Intervertebral Disc Rongeur

CODE	DESCRIPTION	LENGTH	
53-1262	Cup 6 mm	7 in	178 mm



Rongeurs (Intervertebral Disc)

Peapod Intervertebral Disc Rongeur

CODE	DESCRIPTION	LENGTH
57-2092	Angled Up, 3 mm	5½ in 140 mm
57-2094	Angled Up, 4 mm	5½ in 140 mm
53-1255	Curved Up, Cup 2 x 6 mm	5½ in 140 mm



53-1255

Schlesinger Intervertebral Disc Rongeur

Straight, Serrated Cup

CODE	JAWS	LENGTH
53-1190	2 mm	6 in 152 mm
53-1191	3 mm	6 in 152 mm
53-1192	4 mm	6 in 152 mm



53-1190

Schlesinger Intervertebral Disc Rongeur

Angled Up

CODE	DESCRIPTION	LENGTH
57-2435	3 x 10 mm	5 in 125 mm

Selverstone Intervertebral Disc Rongeur

Straight

CODE	DESCRIPTION	LENGTH
53-1325	Cup 2 x 3 mm	6 in 152 mm
53-1326	Cup 2 x 5 mm	6 in 152 mm



53-1325

Rongeurs (Intervertebral Disc)

Spence Intervertebral Disc Rongeur

Straight

CODE	DESCRIPTION	LENGTH
53-1258	Fenestrated Jaw, Cup 3 x 10 mm	6½ in 165 mm



Williams Discectomy Rongeur

CODE	DESCRIPTION	LENGTH
57-2091	2 mm Cup	5½ in 140 mm



Rongeurs (Intervertebral Disc, Spurling)

Spurling IVD Rongeur

Straight

CODE	DESCRIPTION	LENGTH
57-2461	3 x 10 mm, Fenestrated Jaw	5½ in 140 mm



Spurling Intervertebral Disc Rongeur

Straight

CODE	DESCRIPTION	LENGTH
53-1300	Cup 4 x 10 mm	5 in 127 mm



Rongeurs (Intervertebral Disc, Spurling)

Spurling Intervertebral Disc Rongeur

Cup 4 x 10 mm

CODE	DESCRIPTION	LENGTH
53-1210	Straight	6 in 152 mm
53-1240	Straight	6 in 152 mm
53-1212	Curved Down	6 in 152 mm
53-1211	Curved Up	6 in 152 mm



Spurling Intervertebral Disc Rongeur

Cup 4 x 10 mm

CODE	DESCRIPTION	LENGTH
53-1242	Curved Down	7 in 178 mm
53-1241	Curved Up	7 in 178 mm



Spurling Intervertebral Disc Rongeur

4 x 10 mm Jaws, with Teeth

CODE	DESCRIPTION	LENGTH
57-2300	Straight	7 in 175 mm
57-2302	Angled Down	7 in 175 mm



Spurling Rongeur

Angled Down

CODE	DESCRIPTION	LENGTH
57-2274	4 x 10 mm Jaws	6 in 150 mm
57-2275	4 x 10 mm Jaws	9 in 230 mm



Rongeurs (Intervertebral Disc, Spurling)

Spurling Rongeur

Angled Up

CODE	DESCRIPTION	LENGTH
57-2244	4 x 10 mm Jaws	6 in 150 mm
57-2273	4 x 10 mm Jaws	9 in 230 mm
57-2293	4 x 10 mm Jaws	11 in 280 mm



57-2244

Spurling Rongeur

Straight

CODE	JAWS	LENGTH
57-2204	4 x 10 mm	5 in 125 mm
57-2214	4 x 10 mm	6 in 150 mm
57-2224	4 x 10 mm	7 in 175 mm
57-2270	4 x 10 mm	9 in 230 mm
57-2297	4 x 10 mm	12 in 300 mm



Tip

Spurling Opti-Length® Rongeur, IVD

Straight #1

CODE	DESCRIPTION	LENGTH
53-1280	5 x 15 mm	5½ in 140 mm
53-1281	5½ x 15 mm	5½ in 140 mm
53-1282	6 x 15 mm	5½ in 140 mm



53-1280

Spurling Opti-Length® Rongeur, IVD

Cup 4 x 10 mm

CODE	DESCRIPTION	LENGTH
67-7321	Straight	11 in 279 mm
67-7322	Up	11 in 279 mm



67-7322

Rongeurs (Intervertebral Disc, Spurling)

Spurling Opti-Length® Rongeur, IVD

Fenestrated Jaw

CODE	DESCRIPTION	LENGTH	
57-2473	Straight, 5 mm	7 in	178 mm
57-2477	Angled Up, 4 mm	7 in	178 mm

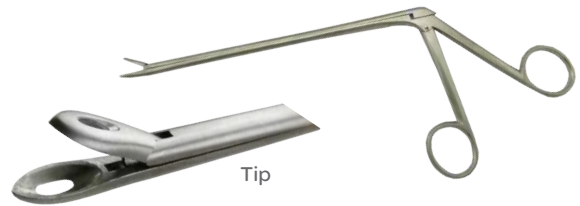

57-2473

Spurling Opti-Length® Rongeur, IVD

Straight

CODE	DESCRIPTION	LENGTH	
57-2493	Fenestrated Jaw	9 in	230 mm

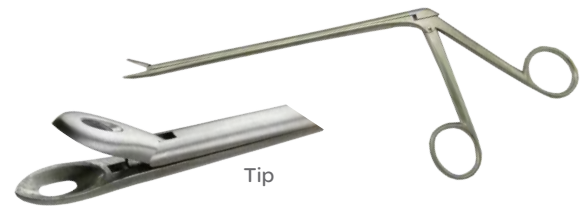

Rongeurs (Kerrison)

Ceramic Coated Micro Kerrison Rongeur

40° Down, Thin Footplate, 9 mm Opening

CODE	DESCRIPTION	LENGTH	
57-0801-BD	1 mm	8 in	200 mm
57-0802-BD	2 mm	8 in	200 mm
57-0803-BD	3 mm	8 in	200 mm
57-0804-BD	4 mm	8 in	200 mm
57-0805-BD	5 mm	8 in	200 mm



Ceramic Coated Micro Kerrison Ejector Rongeur

40° Up, with Ejector, 9 mm Opening

CODE	DESCRIPTION	LENGTH	
57-0392-BD	2 mm	7 in	175 mm
57-0393-BD	3 mm	7 in	175 mm
57-0394-BD	3 mm	7 in	175 mm
57-0395-BD	5 mm	7 in	175 mm



Rongeurs (Kerrison)

Ceramic Coated Micro Kerrison Ejector Rongeur

40° Up, with Ejector, 9 mm Opening

CODE	DESCRIPTION	LENGTH
57-0692-BD	2 mm	8 in 200 mm
57-0693-BD	3 mm	8 in 200 mm
57-0694-BD	4 mm	8 in 200 mm
57-0695-BD	5 mm	8 in 200 mm
57-0696-BD	6 mm	8 in 200 mm

Ceramic Coated Spurling Kerrison Rongeur

40° Up, 15 mm Opening

CODE	DESCRIPTION	LENGTH
57-0582-BD	2 mm	8 in 200 mm
57-0583-BD	3 mm	8 in 200 mm
57-0584-BD	4 mm	8 in 200 mm
57-0585-BD	5 mm	8 in 200 mm

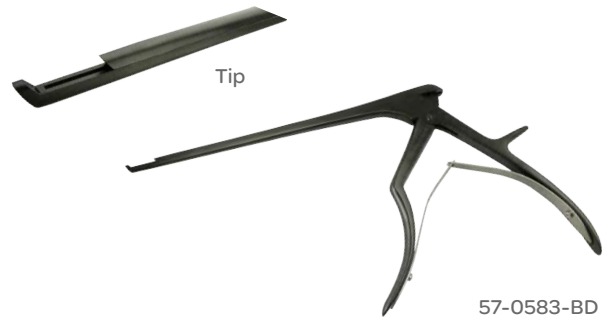

Ceramic Coated Micro Kerrison Rongeur

40° Up, 9 mm Opening

CODE	DESCRIPTION	LENGTH
57-0721-BD	1 mm	7 in 175 mm
57-0722-BD	2 mm	7 in 175 mm
57-0723-BD	3 mm	7 in 175 mm
57-0724-BD	4 mm	7 in 175 mm
57-0725-BD	5 mm	7 in 175 mm
57-0726-BD	6 mm	7 in 175 mm



Rongeurs (Kerrison)

Ceramic Coated Micro Kerrison Rongeur

40° Up, 9 mm Opening

CODE	DESCRIPTION	LENGTH
57-0761-BD	1mm	8 in 200 mm
57-0762-BD	2mm	8 in 200 mm
57-0763-BD	3mm	8 in 200 mm
57-0764-BD	4mm	8 in 200 mm
57-0765-BD	5mm	8 in 200 mm
57-0766-BD	6mm	8 in 200 mm

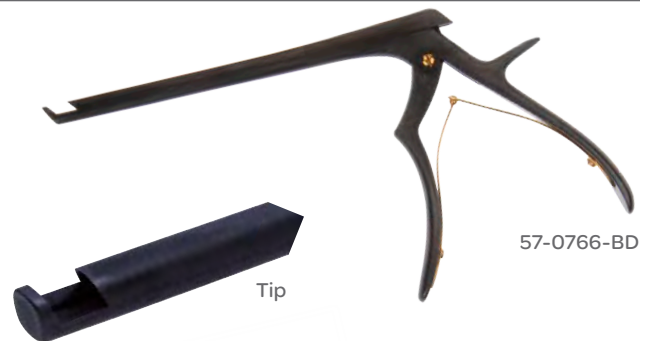

Ceramic Coated Micro Kerrison Rongeur

40° Up, 15 mm Opening, Small Handle

CODE	DESCRIPTION	LENGTH
57-0022-BD	2mm	8 in 200 mm
57-0023-BD	3mm	8 in 200 mm
57-0024-BD	4mm	8 in 200 mm
57-0025-BD	5mm	8 in 200 mm



Ceramic Coated Micro Kerrison Rongeur

40° Up, 9 mm Opening

CODE	DESCRIPTION	LENGTH
57-0891-BD	1mm	9 in 230 mm
57-0892-BD	2mm	9 in 230 mm
57-0893-BD	3mm	9 in 230 mm
57-0894-BD	4mm	9 in 230 mm
57-0895-BD	5mm	9 in 230 mm
57-0896-BD	6mm	9 in 230 mm



Rongeurs (Kerrison)

Ceramic Coated Micro Kerrison Rongeur

90° Up, Thin Footplate, 9 mm Opening

CODE	DESCRIPTION	LENGTH
57-0701-BD	1 mm	7 in 175 mm
57-0702-BD	2 mm	7 in 175 mm
57-0703-BD	3 mm	7 in 175 mm
57-0704-BD	4 mm	7 in 175 mm
57-0705-BD	5 mm	7 in 175 mm

Ceramic Coated Micro Kerrison Rongeur

90° Up, Thin Footplate, 9 mm Opening

CODE	DESCRIPTION	LENGTH
57-0739-BD	1 mm	8 in 200 mm
57-0740-BD	2 mm	8 in 200 mm
57-0743-BD	3 mm	8 in 200 mm
57-0744-BD	4 mm	8 in 200 mm

Ceramic Coated Micro Kerrison Rongeur

90° Down, Thin Footplate, 9 mm Opening

CODE	DESCRIPTION	LENGTH
57-0751-BD	1 mm	8 in 200 mm
57-0750-BD	2 mm	8 in 200 mm
57-0752-BD	3 mm	8 in 200 mm
57-0754-BD	4 mm	8 in 200 mm
57-0755-BD	5 mm	8 in 200 mm

Ceramic Coated Micro Kerrison Convertible Rongeur

40° Up, Thin Footplate

CODE	DESCRIPTION	LENGTH
58-1180-BD	1 mm	7 in 175 mm
58-2180-BD	2 mm	7 in 175 mm
58-3180-BD	3 mm	7 in 175 mm
58-4180-BD	4 mm	7 in 175 mm
58-5180-BD	5 mm	7 in 175 mm



58-1180-BD

Rongeurs (Kerrison)

Ceramic Coated Micro Kerrison Convertible Rongeur

40° Up, Thin Footplate

CODE	DESCRIPTION	LENGTH
58-1230-BD	1mm	9 in 230 mm
58-2230-BD	2mm	9 in 230 mm
58-3230-BD	3mm	9 in 230 mm
58-4230-BD	4mm	9 in 230 mm
58-5230-BD	5mm	9 in 230 mm



58-5230-BD

Ceramic Coated Micro Kerrison Convertible Rongeur

40° Up, Regular Footplate

CODE	DESCRIPTION	LENGTH
59-1230-BD	1mm	9 in 230 mm
59-2230-BD	2mm	9 in 230 mm
59-3230-BD	3mm	9 in 230 mm
59-4230-BD	4mm	9 in 230 mm
59-5230-BD	5mm	9 in 230 mm

Ceramic Coated Micro Kerrison Convertible Rongeur

40° Up, 15 mm Opening

CODE	DESCRIPTION	LENGTH
58-2262-BD	2mm	8 in 200 mm
58-2262-BD	3mm	8 in 200 mm
58-2264-BD	4mm	8 in 200 mm
58-2265-BD	5mm	8 in 200 mm



58-2262-BD

Ferris Smith-Kerrison Rongeur

CODE	DESCRIPTION	LENGTH
57-1020	40° Up, 2mm	7 in 175 mm
57-1011	40° Down, 1mm	7 in 175 mm
57-1470	Straight, 6 x 10 mm	10 in 250 mm
57-1472	Up Biting, 6 x 10 mm	10 in 250 mm

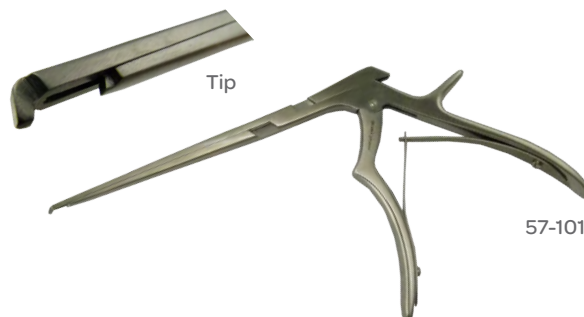

57-1011

Rongeurs (Kerrison)

Kerrison Lumbar Rongeur

40° Up, Hardy™ Style Handle with Ball Spring

CODE	DESCRIPTION	LENGTH
53-1402	3 mm	7 in 178 mm
53-1405	4 mm	7 in 178 mm
53-1408	5 mm	7 in 178 mm
53-1411	6 mm	7 in 178 mm



53-1402

Kerrison Lumbar Rongeur

90° Down, Hardy™ Style Handle with Ball Spring

CODE	DESCRIPTION	LENGTH
53-1404	3 mm	7 in 178 mm
53-1407	4 mm	7 in 178 mm
53-1410	5 mm	7 in 178 mm
53-1413	6 mm	7 in 178 mm



53-1404

Kerrison Lumbar Rongeur

90° Up, Hardy™ Style Handle with Ball Spring

CODE	DESCRIPTION	LENGTH
53-1403	3 mm	7 in 178 mm
53-1406	4 mm	7 in 178 mm
53-1409	5 mm	7 in 178 mm
53-1412	6 mm	7 in 178 mm



Kerrison Lumbar Rongeur

40° Up, Hardy™ Style Handle with Ball Spring

CODE	DESCRIPTION	LENGTH
53-1414	3 mm	8 in 203 mm
53-1417	4 mm	8 in 203 mm
53-1423	6 mm	8 in 203 mm
53-1420	5 mm	8 in 203 mm



53-1414

Rongeurs (Kerrison)

Kerrison Lumbar Rongeur

40° Up

CODE	DESCRIPTION	LENGTH
67-7267	2 mm	10 in 254 mm
67-7270	3 mm	10 in 254 mm
67-7273	4 mm	10 in 254 mm
67-7276	5 mm	10 in 254 mm



67-7267

Kerrison Lumbar Rongeur

40° Up, Hardy™ Style Handle with Ball Spring

CODE	DESCRIPTION	LENGTH
53-1426	3 mm	11 in 279 mm
53-1427	4 mm	11 in 279 mm
53-1428	5 mm	11 in 279 mm
53-1429	6 mm	11 in 279 mm



53-1427

Kerrison Lumbar Rongeur

90° Down, Hardy™ Style Handle with Ball Spring

CODE	DESCRIPTION	LENGTH
53-1416	3 mm	8 in 203 mm
53-1419	4 mm	8 in 203 mm
53-1422	5 mm	8 in 203 mm
53-1425	6 mm	8 in 203 mm



53-1419

Kerrison Lumbar Rongeur

90° Up, Hardy™ Style Handle with Ball Spring

CODE	DESCRIPTION	LENGTH
53-1415	3 mm	8 in 203 mm
53-1418	4 mm	8 in 203 mm
53-1421	5 mm	8 in 203 mm
53-1424	6 mm	8 in 203 mm

Rongeurs (Kerrison)

Micro Rongeur

40° Up, Bayonet

CODE	DESCRIPTION	LENGTH
46-2602	2 mm	2¾ in 70 mm
46-2603	3 mm	2¾ in 70 mm



Micro Kerrison Convertible Rongeur

40° Up, Regular Footplate, with Ejector

CODE	DESCRIPTION	LENGTH
59-3180J	3 mm	7 in 175 mm
59-4180J	4 mm	7 in 175 mm
59-5180J	5 mm	7 in 175 mm

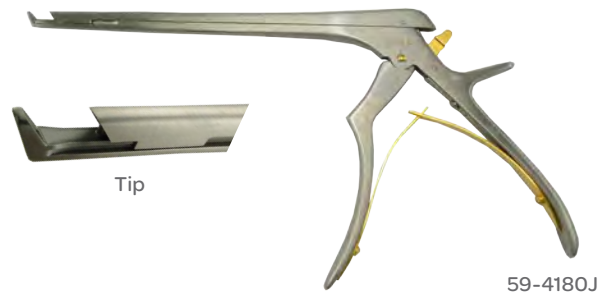

Micro Kerrison Convertible Rongeur

40° Up, Thin Footplate

CODE	DESCRIPTION	LENGTH
58-1200	1 mm	8 in 203 mm
58-2200	2 mm	8 in 203 mm
58-3200	3 mm	8 in 203 mm
58-4200	4 mm	8 in 203 mm
58-5200	5 mm	8 in 203 mm



Micro Kerrison Convertible Rongeur

40° Up, Regular Footplate

CODE	DESCRIPTION	LENGTH
59-1200	1 mm	8 in 203 mm
59-2200	2 mm	8 in 203 mm
59-3200	3 mm	8 in 203 mm
59-4200	4 mm	8 in 203 mm
59-5200	5 mm	8 in 203 mm



Rongeurs (Kerrison)

Micro Kerrison Convertible Ejector Rongeur

40° Up, Thin Footplate, with Ejector

CODE	DESCRIPTION	LENGTH
58-3200J	3 mm	8 in 203 mm
58-4200J	4 mm	8 in 203 mm
58-5200J	5 mm	8 in 203 mm

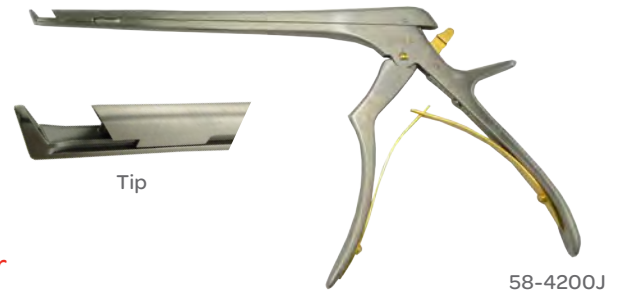

Micro Kerrison Convertible Ejector Rongeur

40° Up, Regular Footplate, with Ejector

CODE	DESCRIPTION	LENGTH
59-3200J	3 mm	8 in 203 mm
59-4200J	4 mm	8 in 203 mm
59-5200J	5 mm	8 in 203 mm



Micro Kerrison Convertible Rongeur

40° Up, 15 mm Opening

CODE	DESCRIPTION	LENGTH
58-2262	2 mm	8 in 200 mm
58-2263	3 mm	8 in 200 mm
58-2264	4 mm	8 in 200 mm
58-2265	5 mm	8 in 200 mm



Micro Kerrison Ejector Rongeur

40° Up, with Ejector, 9 mm Opening

CODE	DESCRIPTION	LENGTH
57-0392	2 mm	7 in 175 mm
57-0393	3 mm	7 in 175 mm
57-0394	4 mm	7 in 175 mm
57-0395	5 mm	7 in 175 mm
57-0396	6 mm	7 in 175 mm



Rongeurs (Kerrison)

Micro Kerrison Ejector Rongeur

40°, 9 mm Opening

CODE	DESCRIPTION	LENGTH
57-0692	2 mm	8 in 200 mm
57-0693	3 mm	8 in 200 mm
57-0694	4 mm	8 in 200 mm
57-0695	5 mm	8 in 200 mm
57-0696	6 mm	8 in 200 mm



57-0692

Micro Kerrison T-Bar Ejector Rongeur

40° Up, Thin Footplate, Small Handle, 9 mm Opening

CODE	DESCRIPTION	LENGTH
57-0852	2.5 mm	8 in 200 mm
57-0853	3 mm	8 in 200 mm
57-0854	4 mm	8 in 200 mm
57-0855	5 mm	8 in 200 mm



57-0853

Micro Rongeur

40° Up, Bayonet

CODE	DESCRIPTION	LENGTH
46-2601	1 mm	2 3/4 in 70 mm



Kerrison Rongeur

70° Up, Curved

CODE	DESCRIPTION	LENGTH
57-1100	2 mm	8 in 200 mm
57-1102	3 mm	8 in 200 mm
57-1104	4 mm	8 in 200 mm
57-1105	5 mm	8 in 200 mm



57-1105

Rongeurs (Kerrison)

Micro Kerrison Rongeur

40° Up, Thin Footplate, 9 mm Opening

CODE	DESCRIPTION	LENGTH
57-0701	1 mm	7 in 175 mm
57-0702	2 mm	7 in 175 mm
57-0703	3 mm	7 in 175 mm
57-0704	4 mm	7 in 175 mm
57-0705	5 mm	7 in 175 mm

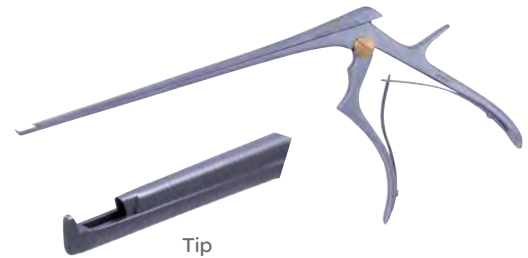

Micro Kerrison Bayonet Rongeur

40° Up, Ceramic

CODE	DESCRIPTION	LENGTH
56-1001-BD	1 mm	6¼ in 160 mm
56-1002-BD	2 mm	6¼ in 160 mm
56-1003-BD	3 mm	6¼ in 160 mm
56-1004-BD	4 mm	6¼ in 160 mm
56-1005-BD	5 mm	6¼ in 160 mm



Micro Kerrison Bayonet Rongeur

90° Up, Ceramic

CODE	DESCRIPTION	LENGTH
56-1201-BD	1 mm	6¼ in 160 mm
56-1202-BD	2 mm	6¼ in 160 mm
56-1203-BD	3 mm	6¼ in 160 mm
56-1204-BD	4 mm	6¼ in 160 mm
56-1205-BD	5 mm	6¼ in 160 mm



Micro Kerrison Rongeur

40° Up, Small Handle, 15 mm Opening

CODE	DESCRIPTION	LENGTH
57-0022	2 mm	8 in 200 mm
57-0023	3 mm	8 in 200 mm
57-0024	4 mm	8 in 200 mm
57-0025	5 mm	8 in 200 mm



Rongeurs (Kerrison)

Micro Kerrison Rongeur

40° Up, Thin Footplate, 9 mm Opening

CODE	DESCRIPTION	LENGTH
57-0761	1 mm	8 in 200 mm
57-0761.5	1.5 mm	8 in 200 mm
57-0762	2 mm	8 in 200 mm
57-0763	3 mm	8 in 200 mm
57-0764	4 mm	8 in 200 mm
57-0765	5 mm	8 in 200 mm
57-0766	6 mm	8 in 200 mm

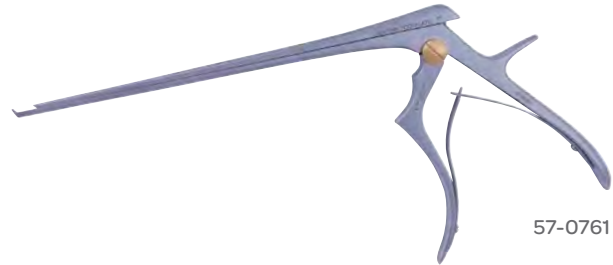

57-0761

Micro Kerrison Rongeur

40° Up, Thin Footplate, 15 mm Opening

CODE	DESCRIPTION	LENGTH
57-0762.15	2 mm	8 in 200 mm
57-0763.15	3 mm	8 in 200 mm
57-0764.15	4 mm	8 in 200 mm
57-0765.15	5 mm	8 in 200 mm



57-0762.15

Micro Kerrison Rongeur

40° Up, Thin Footplate, 9 mm Opening

CODE	DESCRIPTION	LENGTH
57-0891	1 mm	9 in 230 mm
57-0892	2 mm	9 in 230 mm
57-0893	3 mm	9 in 230 mm
57-0894	4 mm	9 in 230 mm
57-0895	5 mm	9 in 230 mm
57-0896	6 mm	9 in 230 mm



57-0891

Micro Kerrison Rongeur

40° Up, Thin Footplate, 9 mm Opening

CODE	DESCRIPTION	LENGTH
57-0101	1 mm	10 in 250 mm
57-0102	2 mm	10 in 250 mm
57-0103	3 mm	10 in 250 mm
57-0104	4 mm	10 in 250 mm
57-0105	5 mm	10 in 250 mm



57-0102

Rongeurs (Kerrison)

Micro Kerrison Rongeur

40° Up, Thin Footplate, 9 mm Opening

CODE	DESCRIPTION	LENGTH
57-0991	1 mm	11 in 280 mm
57-0992	2 mm	11 in 280 mm
57-0993	3 mm	11 in 280 mm
57-0994	4 mm	11 in 280 mm
57-0995	5 mm	11 in 280 mm
57-0996	6 mm	11 in 280 mm

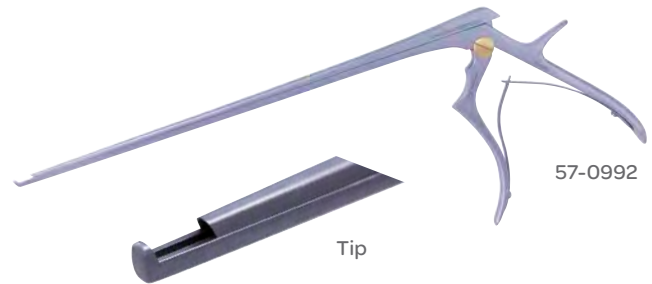

Micro Kerrison Rongeur

40° Up, Thin Footplate, 9 mm Opening

CODE	DESCRIPTION	LENGTH
57-0112	2 mm	12 in 305 mm
57-0113	3 mm	12 in 305 mm
57-0114	4 mm	12 in 305 mm
57-0115	5 mm	12 in 305 mm



Micro Kerrison Rongeur

90° Down

CODE	DESCRIPTION	LENGTH
57-0751	1 mm	8 in 200 mm
57-0750	2 mm	8 in 200 mm
57-0753	3 mm	8 in 200 mm
57-0754	4 mm	8 in 200 mm
57-0755	5 mm	8 in 200 mm
57-0756	6 mm	8 in 200 mm



Micro Kerrison Rongeur

90° Up, Thin Footplate, 9 mm Opening

CODE	DESCRIPTION	LENGTH
57-0901	1 mm	9 in 230 mm
57-0902	2 mm	9 in 230 mm
57-0903	3 mm	9 in 230 mm
57-0904	4 mm	9 in 230 mm
57-0905	5 mm	9 in 230 mm



Rongeurs (Kerrison)

Micro Kerrison Rongeur

90° Up, Thin Footplate, 9 mm Opening

CODE	DESCRIPTION	LENGTH
57-0739	1 mm	8 in 200 mm
57-0740	2 mm	8 in 200 mm
57-0743	3 mm	8 in 200 mm
57-0744	4 mm	8 in 200 mm
57-0745	5 mm	8 in 200 mm
57-0746	6 mm	8 in 200 mm



57-0739

Micro Kerrison Rongeur

90° Up, Thin Footplate, 9 mm Opening

CODE	DESCRIPTION	LENGTH
57-0911	1 mm	10 in 250 mm
57-0912	2 mm	10 in 250 mm
57-0913	3 mm	10 in 250 mm
57-0914	4 mm	10 in 250 mm
57-0915	5 mm	10 in 250 mm



57-0912

Micro Kerrison Rongeur

40° Up, with Ultra Coat

CODE	DESCRIPTION	LENGTH
57-0761UC	1 mm	8 in 200 mm
57-0762UC	2 mm	8 in 200 mm
57-0763UC	3 mm	8 in 200 mm
57-0764UC	4 mm	8 in 200 mm
57-0765UC	5 mm	8 in 200 mm



57-0764UC

Tip

Micro Kerrison Rongeur

40° Up, with Ultra Coat

CODE	DESCRIPTION	LENGTH
57-0891UC	1 mm	9 in 230 mm
57-0892UC	2 mm	9 in 230 mm
57-0893UC	3 mm	9 in 230 mm
57-0894UC	4 mm	9 in 230 mm
57-0895UC	5 mm	9 in 230 mm



57-0894UC

Tip

Rongeurs (Kerrison)

Micro Kerrison Rongeur

40° Up, Thin Footplate, with Ultra Coat, 9 mm Opening

CODE	DESCRIPTION	LENGTH
57-0991UC	1 mm	11 in 280 mm
57-0992UC	2 mm	11 in 280 mm
57-0993UC	3 mm	11 in 280 mm
57-0994UC	4 mm	11 in 280 mm
57-0995UC	5 mm	11 in 280 mm



Micro Kerrison Rongeur

40° Up, Small Handle, 15 mm Opening

CODE	DESCRIPTION	LENGTH
57-0022UC	2 mm	8 in 200 mm
57-0023UC	3 mm	8 in 200 mm
57-0024UC	4 mm	8 in 200 mm
57-0025UC	5 mm	8 in 200 mm



Micro Kerrison Convertible Rongeur

40° Up, Thin Footplate

CODE	DESCRIPTION	LENGTH
58-1180	1 mm	7 in 175 mm
58-2180	2 mm	7 in 175 mm
58-3180	3 mm	7 in 175 mm
58-4180	4 mm	7 in 175 mm
58-5180	5 mm	7 in 175 mm

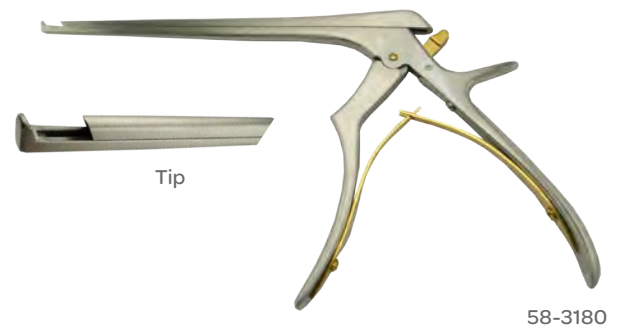

Micro Kerrison Convertible Ejector Rongeur

40° Up, Thin Footplate, with Ejector

CODE	DESCRIPTION	LENGTH
58-3180J	3 mm	7 in 175 mm
58-4180J	4 mm	7 in 175 mm
58-5180J	5 mm	7 in 175 mm



Rongeurs (Kerrison)

Micro Kerrison Convertible Rongeur

40° Up, Regular Footplate

CODE	DESCRIPTION	LENGTH	
59-1180	1 mm	7 in	175 mm
59-2180	2 mm	7 in	175 mm
59-3180	3 mm	7 in	175 mm
59-4180	4 mm	7 in	175 mm
59-5180	5 mm	7 in	175 mm



59-3180

Microsect® Shaver Rongeur

45° Up

CODE	DESCRIPTION	LENGTH	
47-5030	1.5 mm	8 ½ in	216 mm
47-5031	2 mm	8 ½ in	216 mm
47-5032	2.5 mm	8 ½ in	216 mm
47-5033	3 mm	8 ½ in	216 mm
47-5034	4 mm	8 ½ in	216 mm



47-5030

Microsect® Shaver Rongeur

45° Up

CODE	DESCRIPTION	LENGTH	
67-7309	1.5 mm	10 in	254 mm
67-7310	2 mm	10 in	254 mm
67-7311	2.5 mm	10 in	254 mm
67-7312	3 mm	10 in	254 mm
67-7313	4 mm	10 in	254 mm



67-7309

Microsect® Shaver Rongeur

45° Up

CODE	DESCRIPTION	LENGTH	
67-7314	1.5 mm	12 in	305 mm
67-7315	2 mm	12 in	305 mm
67-7316	2.5 mm	12 in	305 mm
67-7317	3 mm	12 in	305 mm
67-7318	4 mm	12 in	305 mm



67-7314

Rongeurs (Kerrison)

Opti-Length® Kerrison Lumbar Rongeur

40°

CODE	DESCRIPTION	LENGTH
67-7282	2 mm	12 in 305 mm
67-7285	3 mm	12 in 305 mm
67-7288	4 mm	12 in 305 mm



67-7282

Opti-Length® Kerrison Lumbar Rongeur

CODE	DESCRIPTION	LENGTH
67-7325	1 mm	15 in 380 mm
67-7326	2 mm	15 in 380 mm
67-7327	3 mm	15 in 380 mm
67-7328	4 mm	15 in 380 mm
67-7329	5 mm	15 in 380 mm
67-7330	1 mm	15 in 380 mm
67-7331	2 mm	15 in 380 mm
67-7332	3 mm	15 in 380 mm
67-7333	4 mm	15 in 380 mm
67-7334	5 mm	15 in 380 mm



67-7325

Opti-Length® Microsect® Shaver Rongeur

45°, Up Bite

CODE	TIP SIZE	LENGTH
67-7309	1.5 mm	10 in 254 mm
67-7310	2 mm	10 in 254 mm
67-7311	2.5 mm	10 in 254 mm
67-7312	3 mm	10 in 254 mm
67-7313	4 mm	10 in 254 mm
67-7314	1.5 mm	12 in 305 mm
67-7315	2 mm	12 in 305 mm
67-7316	2.5 mm	12 in 305 mm
67-7317	3 mm	12 in 305 mm
67-7318	4 mm	12 in 305 mm



67-7313

Rongeurs (Kerrison, Cervical)

Classic® T-F Cervical Rongeur

CODE	DESCRIPTION	LENGTH
53-1537	1mm	7 in 178 mm



Tip

Classic® T-F Cervical Rongeur

40° Up

CODE	DESCRIPTION	LENGTH
53-1539	1mm	7 in 178 mm



Kerrison Cervical Rongeur

40° Up, Thin Footplate

CODE	DESCRIPTION	LENGTH
53-1500C	2 mm	6 in 152 mm
53-1503	3 mm	6 in 152 mm
53-1506	4 mm	6 in 152 mm
53-1509	5 mm	6 in 152 mm

Rongeurs (Kerrison, Cervical)

Kerrison Cervical Rongeur

40° Up, Thin Footplate

CODE	DESCRIPTION	LENGTH
53-1512	2 mm	7 in 178 mm
53-1515	3 mm	7 in 178 mm
53-1518	4 mm	7 in 178 mm
53-1521	5 mm	7 in 178 mm

Kerrison Cervical Rongeur

40° Up, Thin Footplate

CODE	DESCRIPTION	LENGTH
53-1524	2 mm	8 in 203 mm
53-1527	3 mm	8 in 203 mm
53-1530	4 mm	8 in 203 mm
53-1533	5 mm	8 in 203 mm

Kerrison Cervical Rongeur

90° Down, Thin Footplate

CODE	DESCRIPTION	LENGTH
53-1502	2 mm	6 in 152 mm
53-1505	3 mm	6 in 152 mm
53-1508	4 mm	6 in 152 mm
53-1511	5 mm	6 in 152 mm



53-1502

Kerrison Cervical Rongeur

90° Down, Thin Footplate

CODE	DESCRIPTION	LENGTH
53-1514	2 mm	7 in 178 mm
53-1517	3 mm	7 in 178 mm
53-1520	4 mm	7 in 178 mm
53-1523	5 mm	7 in 178 mm



Tip

Rongeurs (Kerrison, Cervical)

Kerrison Cervical Rongeur

90° Down, Thin Footplate

CODE	DESCRIPTION	LENGTH
53-1526	2 mm	8 in 203 mm
53-1529	3 mm	8 in 203 mm
53-1532	4 mm	8 in 203 mm
53-1535	5 mm	8 in 203 mm

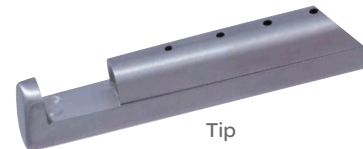

Tip

53-1535

Kerrison Cervical Rongeur

90° Up, Thin Footplate

CODE	DESCRIPTION	LENGTH
53-1501	2 mm	6 in 152 mm
53-1504	3 mm	6 in 152 mm
53-1507	4 mm	6 in 152 mm
53-1510	5 mm	6 in 152 mm

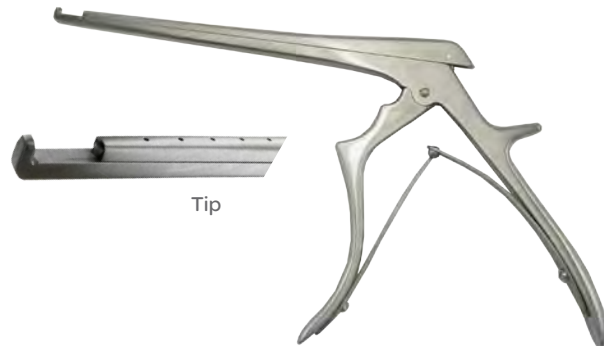

Tip

53-1504

Kerrison Cervical Rongeur

90° Up, Thin Footplate

CODE	DESCRIPTION	LENGTH
53-1513	2 mm	7 in 178 mm
53-1516	3 mm	7 in 178 mm
53-1519	4 mm	7 in 178 mm
53-1522	5 mm	7 in 178 mm

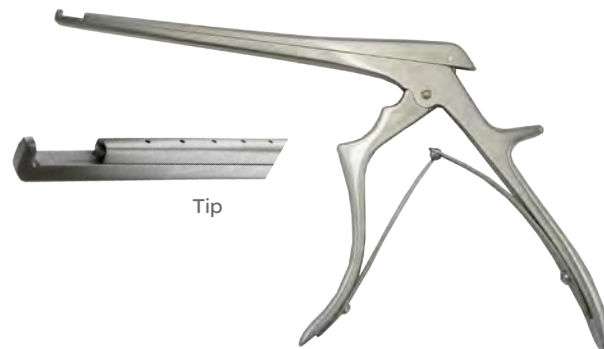

Tip

53-1516

Kerrison Cervical Rongeur

90° Up, Thin Footplate

CODE	DESCRIPTION	LENGTH
53-1525	2 mm	8 in 203 mm
53-1528	3 mm	8 in 203 mm
53-1531	4 mm	8 in 203 mm
53-1534	5 mm	8 in 203 mm

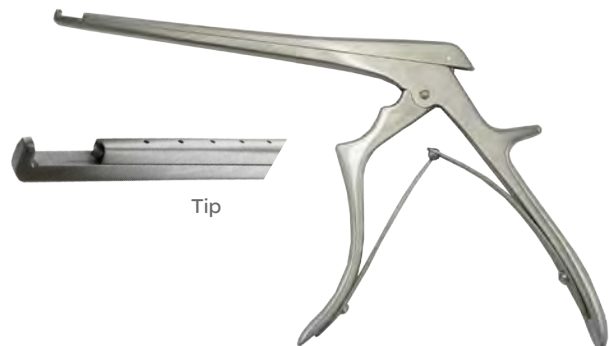

Tip

53-1528

Rongeurs (Kerrison, Cervical)

RapidClean® Cervical Kerrison Rongeur

40° Up, Detachable

CODE	DESCRIPTION	LENGTH
53-1540CD	1 mm	7 in 180 mm
53-1542CD	2 mm	7 in 180 mm
53-1544CD	3 mm	7 in 180 mm
53-1546CD	4 mm	7 in 180 mm

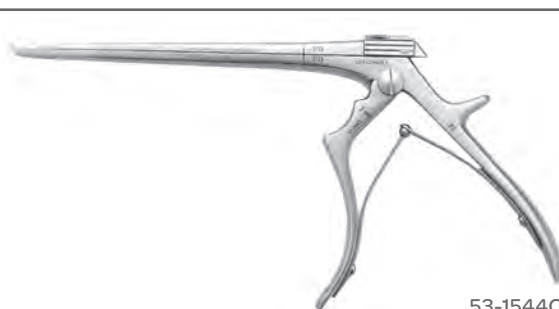

53-1544CD

RapidClean® Cervical Kerrison Rongeur

40° Up, Detachable

CODE	DESCRIPTION	LENGTH
53-1570CD	1 mm	8 in 200 mm
53-1572CD	2 mm	8 in 200 mm
53-1574CD	3 mm	8 in 200 mm
53-1576CD	4 mm	8 in 200 mm



Tip

53-1570CD

RapidClean® Cervical Kerrison Rongeur

40° Up, Detachable

CODE	DESCRIPTION	LENGTH
53-1548CD	1 mm	9 in 230 mm
53-1550CD	2 mm	9 in 230 mm
53-1552CD	3 mm	9 in 230 mm
53-1554CD	4 mm	9 in 230 mm



53-1550CD

Schlesinger Cervical Laminectomy Rongeur

CODE	DESCRIPTION	BITE	LENGTH
53-1382	Down Biting	3 mm	6 in 152 mm
53-1383	Down Biting	5 mm	6 in 152 mm
53-1380	Up Biting	3 mm	6 in 152 mm
53-1381	Up Biting	5 mm	6 in 152 mm

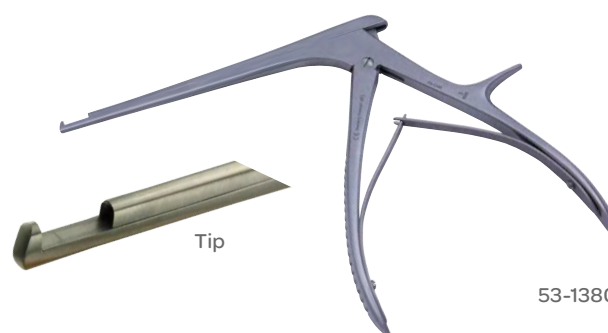

Tip

53-1380

Rongeurs (Kerrison, Laminectomy)

Echlin Laminectomy Rongeur

Angular, Double Action

CODE	DESCRIPTION	LENGTH
53-1045	2 mm	8 ³ / ₄ in 222 mm
53-1046	3 mm	8 ³ / ₄ in 222 mm
53-1047	4 mm	8 ³ / ₄ in 222 mm



53-1045

Ferris-Smith Kerrison Rongeur

CODE	DESCRIPTION	LENGTH
53-1158	Down Biting, 5 mm	6 in 152 mm
53-1157	Up Biting, 5 mm	6 in 152 mm
67-7323		11 in



53-1157

Kerrison Laminectomy Rongeur

Down Biting Shaft

CODE	DESCRIPTION	LENGTH
53-1374	3 mm	6 in 152 mm
53-1375	5 mm	6 in 152 mm
53-1376	3 mm	7 ¹ / ₂ in 191 mm
53-1377	5 mm	7 ¹ / ₂ in 191 mm

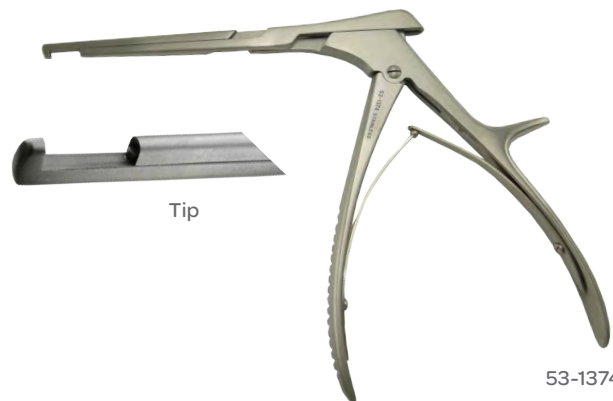

53-1374

Rongeurs (Kerrison, Laminectomy)

Laminectomy Rongeur

40° Up

CODE	DESCRIPTION	LENGTH
51-1085	3 mm	6 ⁷ / ₈ in 174 mm
51-1086	5 mm	6 ⁷ / ₈ in 174 mm
51-1087	3 mm	8 in 203 mm
51-1088	5 mm	8 in 203 mm



51-1085

Leksell Laminectomy Rongeur

Double Action, 8 mm

CODE	DESCRIPTION	LENGTH
53-1127	Regular Curve, Narrow Bite	9 in 229 mm
53-1125	Regular Curve, Wide Jaw	9 in 229 mm
53-1128	Full Curve, Narrow Bite	9 in 229 mm
53-1126	Full Curve, Wide Jaw	9 in 229 mm

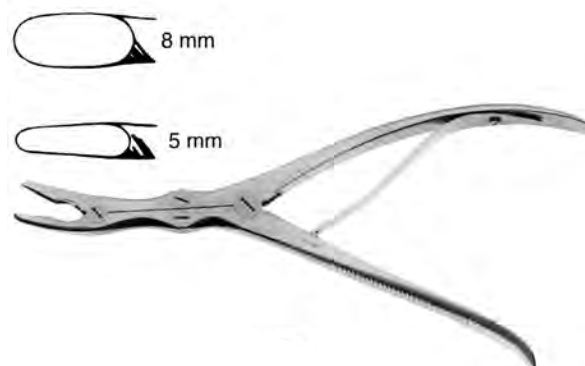

53-1127

Leksell Laminectomy Rongeur

Double Action

CODE	DESCRIPTION	LENGTH
67-7900	Regular Curve, 1 mm	14 in 356mm
67-7901	Regular Curve, 2 mm	14 in 356 mm
67-7902	Regular Curve, 3 mm	14 in 356 mm
67-7903	Regular Curve, 4 mm	14 in 356 mm
67-7904	Regular Curve, 5 mm	14 in 356 mm
67-7905	Regular Curve, 6 mm	14 in 356 mm
67-7912	Full Curve, 1 mm	14 in 356 mm
67-7913	Full Curve, 2 mm	14 in 356 mm
67-7914	Full Curve, 3 mm	14 in 356 mm
67-7915	Full Curve, 4 mm	14 in 356 mm
67-7916	Full Curve, 5 mm	14 in 356 mm
67-7917	Full Curve, 6 mm	14 in 356 mm



67-7917

Rongeurs (Kerrison, Laminectomy)

Raney Laminectomy Rongeurs

CODE	DESCRIPTION	LENGTH
51-1066	7 mm	7½ in 191 mm



Rongeurs (Kerrison, Pituitary)

Pituitary Rongeur

Bayonet, Ceramic

CODE	DESCRIPTION	LENGTH
56-2112-BD	Straight, 2 x 8 mm	6¼ in 160 mm
56-2114-BD	Straight, 2 x 10 mm	6¼ in 160 mm
56-2116-BD	Angled, 2 x 8 mm	6¼ in 160 mm



56-2116-BD

Rongeurs (Kerrison, Rapidclean®)

Ceramic Coated Micro Kerrison Convertible Rongeur

40° Up, Regular Footplate

CODE	DESCRIPTION	LENGTH
59-1180-BD	1 mm	7 in 175 mm
59-2180-BD	2 mm	7 in 175 mm
59-3180-BD	3 mm	7 in 175 mm
59-4180-BD	4 mm	7 in 175 mm
59-5180-BD	5 mm	7 in 175 mm



59-1180-BD

Rongeurs (Kerrison, Rapidclean®)

Ceramic Coated Micro Kerrison Convertible Rongeur

40° Up, Thin Footplate

CODE	DESCRIPTION	LENGTH
58-1200-BD	1 mm	8 in 200 mm
58-2200-BD	2 mm	8 in 200 mm
58-3200-BD	3 mm	8 in 200 mm
58-4200-BD	4 mm	8 in 200 mm
58-5200-BD	5 mm	8 in 200 mm



58-1200-BD

Ceramic Coated Micro Kerrison Convertible Rongeur with Ejector

40° Up, Thin Footplate

CODE	DESCRIPTION	LENGTH
58-3200J-BD	1 mm	8 in 200 mm
58-4200J-BD	2 mm	8 in 200 mm
58-5200J-BD	3 mm	8 in 200 mm

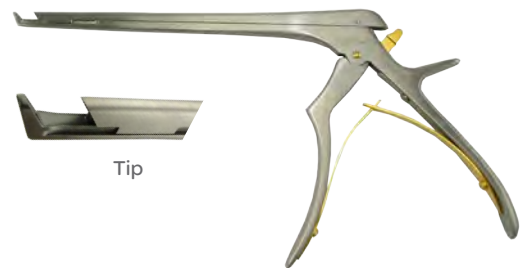

Tip

Ceramic Coated Micro Kerrison Convertible Rongeur

40° Up, Regular Footplate

CODE	DESCRIPTION	LENGTH
59-1200-BD	1 mm	8 in 200 mm
59-2200-BD	2 mm	8 in 200 mm
59-3200-BD	3 mm	8 in 200 mm
59-4200-BD	4 mm	8 in 200 mm
59-5200-BD	5 mm	8 in 200 mm



59-1200-BD

Micro Kerrison Convertible Ejector Rongeur

40° Up, Thin Footplate

CODE	DESCRIPTION	LENGTH
58-1230	1 mm	9 in 230 mm
58-2230	2 mm	9 in 230 mm
58-3230	3 mm	9 in 230 mm
58-4230	4 mm	9 in 230 mm
58-5230	5 mm	9 in 230 mm



Tip

Rongeurs (Kerrison, Rapidclean®)

Micro Kerrison Convertible Ejector Rongeur

40° Up, Regular Footplate

CODE	DESCRIPTION	LENGTH
59-1230	1 mm	9 in 230 mm
59-2230	2 mm	9 in 230 mm
59-3230	3 mm	9 in 230 mm
59-4230	4 mm	9 in 230 mm
59-5230	5 mm	9 in 230 mm



59-3230

Micro Kerrison Convertible Ejector Rongeur

40° Up, Thin Footplate

CODE	DESCRIPTION	LENGTH
58-3230 J	3 mm	9 in 230 mm
58-4230 J	4 mm	9 in 230 mm
58-5230 J	5 mm	9 in 230 mm

Ceramic Coated Micro Kerrison Convertible Rongeur with Ejector

40° Up, Thin Footplate

CODE	DESCRIPTION	LENGTH
58-3230J-BD	3 mm	9 in 230 mm
58-4230J-BD	4 mm	9 in 230 mm
58-5230J-BD	5 mm	9 in 230 mm

Micro Kerrison Convertible Ejector Rongeur

40° Up, Regular Footplate, with Ejector

CODE	DESCRIPTION	LENGTH
59-3230 J	3 mm	9 in 230 mm
59-4230 J	4 mm	9 in 230 mm
59-5230 J	5 mm	9 in 230 mm

Rongeurs (Kerrison, Rapidclean®)

RapidClean® Kerrison Detachable Lumbar Rongeur

40° Up

CODE	DESCRIPTION	LENGTH	
53-1612LD	2 mm	7 in	178 mm
53-1615LED	3 mm	7 in	178 mm
53-1618LED	4 mm	7 in	178 mm



53-1612LD

RapidClean® Kerrison Detachable Lumbar Rongeur

40° Up

CODE	DESCRIPTION	LENGTH	
53-1624LD	2 mm	8 in	203 mm
53-1627LED	3 mm	8 in	203 mm
53-1630LED	4 mm	8 in	203 mm
53-1633LED	5 mm	8 in	203 mm
53-1636LED	6 mm	8 in	203 mm



53-1627LED

RapidClean® Kerrison Detachable Lumbar Rongeur

40° Up

CODE	DESCRIPTION	LENGTH	
53-1642LD	2 mm	9 in	229 mm
53-1645LED	3 mm	9 in	229 mm
53-1648LED	4 mm	9 in	229 mm
53-1651LED	5 mm	9 in	229 mm
53-1654LED	6 mm	9 in	229 mm



53-1645LED

Rongeurs (Kerrison, Rapidclean®)

RapidClean® Opti-Length® Kerrison Detachable Lumbar Rongeur

40° Up Bite with Ejector

CODE	DESCRIPTION	LENGTH	
677297LED	2 mm	10 in	254 mm
677298LED	2 mm	11 in	280 mm
677299LED	3 mm	10 in	254 mm
677300LED	3 mm	11 in	280 mm
677304LED	2 mm	12 in	305 mm
677305LED	3 mm	12 in	305 mm



Rongeurs (Kerrison, Spurling)

Micro Kerrison Rongeur

40° Up, Thin Footplate

CODE	DESCRIPTION	LENGTH	
57-0602	2 mm	6 in	150 mm
57-0603	3 mm	6 in	150 mm
57-0604	4 mm	6 in	150 mm
57-0605	5 mm	6 in	150 mm



Spurling-Kerrison Rongeur

40° Up, with Ultra Coat, 15 mm Opening

CODE	DESCRIPTION	LENGTH	
57-0582UC	2 mm	8 in	200 mm
57-0583UC	3 mm	8 in	200 mm
57-0584UC	4 mm	8 in	200 mm
57-0585UC	5 mm	8 in	200 mm



Rongeurs (Kerrison, Spurling)

Spurling-Kerrison Rongeur

40° Up, 15 mm Opening

CODE	DESCRIPTION	LENGTH
57-0582	2 mm	8 in 200 mm
57-0583	3 mm	8 in 200 mm
57-0584	4 mm	8 in 200 mm
57-0585	5 mm	8 in 200 mm
57-0586	6 mm	8 in 200 mm

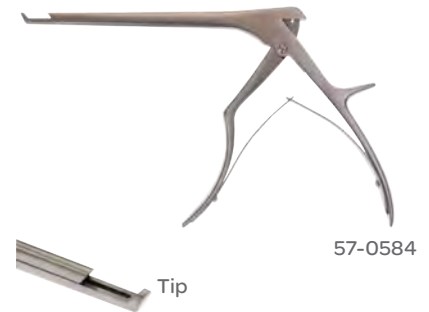

Spurling-Kerrison Rongeur

40° Up, 15 mm Opening

CODE	DESCRIPTION	LENGTH
57-0782	2 mm	9 in 230 mm
57-0783	3 mm	9 in 230 mm
57-0784	4 mm	9 in 230 mm
57-0785	5 mm	9 in 230 mm
57-0786	6 mm	9 in 230 mm



Spurling-Kerrison Rongeur

40° Up, 15 mm Opening

CODE	DESCRIPTION	LENGTH
57-0882	2 mm	10 in 250 mm
57-0883	3 mm	10 in 250 mm
57-0884	4 mm	10 in 250 mm
57-0885	5 mm	10 in 250 mm
57-0886	6 mm	10 in 250 mm



Rongeurs (Kerrison, Spurling)

Spurling-Kerrison Rongeur

90° Down, 15 mm Opening

CODE	DESCRIPTION	LENGTH
57-0572	2 mm	8 in 200 mm
57-0573	3 mm	8 in 200 mm
57-0574	4 mm	8 in 200 mm
57-0575	5 mm	8 in 200 mm



57-0572

Spurling-Kerrison Rongeur

40° Up, 15 mm Opening

CODE	DESCRIPTION	LENGTH
57-0592	2 mm	11 in 280 mm
57-0593	3 mm	11 in 280 mm
57-0594	4 mm	11 in 280 mm
57-0595	5 mm	11 in 280 mm



57-0594

Spurling-Kerrison Rongeur

90° Up, 15 mm Opening

CODE	DESCRIPTION	LENGTH
57-0562	2 mm	8 in 200 mm
57-0563	3 mm	8 in 200 mm
57-0564	4 mm	8 in 200 mm
57-0565	5 mm	8 in 200 mm

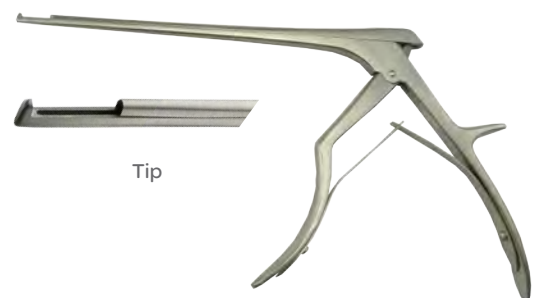

57-0562

Screws (Distraction)

Distraction Screw

5/Per Box, Sterile

CODE	DESCRIPTION	LENGTH
57-5106T	12 mm	
57-5107T	14 mm	
57-5108T	16 mm	



57-5107T

Spreaders (Vertebral)

Cloward Style Vertebra Spreader

CODE	DESCRIPTION	LENGTH
57-5583	65 mm	5 ⁷ / ₈ in
57-5584	75 mm	6 ¹ / ₄ in
57-5585	85 mm	6 ¹ / ₄ in



57-5583

Spreaders (Lamina)

Cloward Style Lamina Spreader

With Ratchet

CODE	DESCRIPTION
57-5581	Teeth on Tips



57-5581

Spreaders (Lamina)

Inge Lamina Spreader

Child

CODE	TOTAL JAW OPENING	LENGTH
57-5505		6 ¼ in 159 mm
61-2516	¼ in 32 mm	6 ¼ in 159 mm



61-2516

Inge Lamina Spreader

CODE	DESCRIPTION	LENGTH
57-5503	Straight Body, Without Teeth	9 ½ in 241 mm
57-5504	With Teeth	9 ½ in 241 mm
57-5507	Without Teeth	9 ½ in 241 mm
57-5509	Without Teeth	9 ½ in 241 mm
57-5510	Without Teeth	9 ½ in 241 mm
61-2515	Adult, Total Jaw Opening 2 ½ in (64 mm)	10 in 250 mm
57-5506	Adult	10 in 250 mm
57-5503C	Curved Body	10 ¾ in 273 mm



57-5506

Lamina Spreader

CODE	DESCRIPTION	LENGTH
61-2525	Total Jaw Opening 2 in (51 mm)	9 ½ in 241 mm



Spreaders (Vertebral)

Vertebra Spreader

CODE	DESCRIPTION	LENGTH
61-1004	#1, with Ratchet, Total Opening $\frac{3}{4}$ in (19 mm)	5 in 127 mm
61-1005	#2, with Ratchet, Total Opening $1\frac{1}{2}$ in (38 mm)	3 in 76 mm



61-1004

Containers

RapidClean® Sterilization Tray

CODE
53-1660



Suction Tubes

Fukushima

Tapered Teardrop, Thumb Control

CODE	DESCRIPTION	LENGTH	
67-7868	4 French	9 in	228 mm
67-7869	5 French	9 in	228 mm
67-7870	6 French	9 in	228 mm
67-7871	7 French	9 in	228 mm
67-7872	8 French	9 in	228 mm
67-7873	9 French	9 in	228 mm



Tear-Drop Suction Tube

Tapered Tube, Malleable Stainless Steel

CODE	DESCRIPTION	LENGTH	
57-4076	6 French	7 in	175 mm
57-4077	7 French	7 in	175 mm
57-4078	8 French	7 in	175 mm
57-4079	9 French	7 in	175 mm
57-4080	10 French	7 in	175 mm
57-4082	12 French	7 in	175 mm
57-4085	5 French	8 in	200 mm

Williams Microlumbar Discectomy Suction Retractor

CODE	DESCRIPTION	LENGTH	
80-1655	16 French	6 in	152 mm

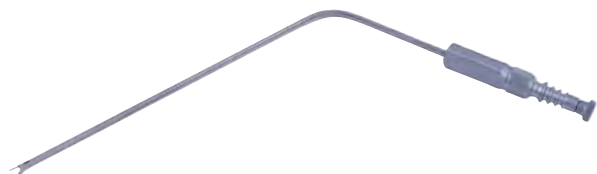

Suction Tubes

Wire Stylets

CODE	DESCRIPTION	LENGTH
46-4000	Used with Dural Suction Retractors for Cleaning and Storage.	

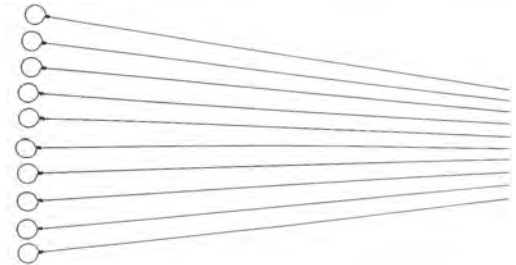

Suction Tubes (Dural)

90° Dural Suction Retractor

Standard Macro, Black

CODE	DESCRIPTION	TIP WIDTH	TIP DEPTH	LENGTH
46-3013		3/8 in 9.5 mm	1/4 in 6 mm	4 3/4 x 4 1/2 in 12 x 114 mm



Dural Suction Retractor (Extended Macro)

90°, Black

CODE	WORKING DISTANCE	LENGTH
46-3015	5 3/4 in 146 mm	3/8 x 1/4 x 4 5/8 in 9.5 x 6 x 117 mm
46-3014	5 3/4 in 146 mm	1/4 x 1/4 x 4 5/8 in 6 x 6 x 117 mm



46-3015

Suction Tubes (Holder)

Crockard™ Suction Tube Holder

Diameter $\frac{3}{16}$ in (7 mm)

CODE	DESCRIPTION	LENGTH
50-1657	Short	1½ in 38 mm
50-1658	Long	2 in 51 mm



50-1657



50-1658

Tamps

Sypert Tamp

CODE	DESCRIPTION	LENGTH
27-9534	4 x 10 mm	11½ in 290 mm
27-9535	5 x 15 mm	11½ in 290 mm
27-9536	6 x 20 mm	11½ in 290 mm



27-9534

Tamps (ACF)

Ultra™ ACF Bone Tamp

CODE	DESCRIPTION	LENGTH
59-0121	3 mm	
59-0122	5 mm	
59-0123	8 mm	



59-0121

Tamps

Bone Tamp

CODE	DESCRIPTION	LENGTH
27-9502	2 mm	6 in 150 mm
27-9503	3 mm	6 in 150 mm
27-9504	4 mm	6 in 150 mm
27-9505	5 mm	6 in 150 mm
27-9506	6 mm	6 in 150 mm
27-9507	7 mm	6 in 150 mm
27-9510	10 mm	6 in 150 mm



27-9502

Caspar Bone Tamp

CODE	DESCRIPTION	LENGTH
27-9601	3 mm	8 in 200 mm
27-9602	5 mm	8 in 200 mm
27-9603	8 mm	8 in 200 mm
27-9516	5 mm	8 in 200 mm
27-9520	12 mm	8 in 200 mm



27-9601

Pliers (Spine)

Pin Pulling Pliers

CODE	DESCRIPTION	LENGTH
32-048	3 mm Tip, Tungsten Carbide Jaws	5 1/2 in 140 mm

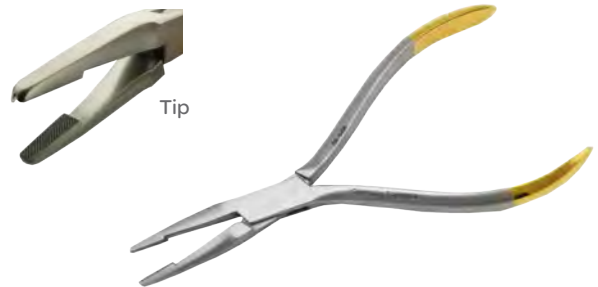

Tip

Wire Extraction Pliers

CODE	DESCRIPTION	LENGTH
32-113	6 mm Jaw, Tungsten Carbide Jaws	7 in 178 mm



Tip

Trephines

Galt Trephines

CODE	DESCRIPTION
57-6313	½ in 12 mm



Michele Trephine

CODE	DESCRIPTION
57-6305	6 ¼ in Shaft Graduated ¼ in - 1 ¼ in (5 mm)



Wire and Pin Cutters

Flush Wire Cable Cutter

CODE	DESCRIPTION	LENGTH
32-129	Tungsten Carbide Jaws	7 in 178 mm



Wire and Pin Cutters

Kirschner Wire Cutter

CODE	DESCRIPTION	LENGTH
56-2507	Chrome Plated	11¼ in 159 mm



Side Cutting Forceps

Double Action

CODE	DESCRIPTION	LENGTH
32-3371	Straight Jaw	9 in 229 mm
32-3372	Angled Jaw	6½ in 165 mm
32-3373	Angled Jaw	9 in 229 mm

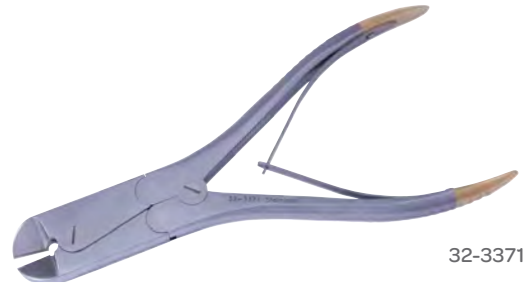

32-3371

Side Cutting Forceps

Max Capacity 1.6 mm

CODE	DESCRIPTION	LENGTH
32-118	Tungsten Carbide Jaws	7 in 178 mm
32-119	Tungsten Carbide Jaws	8 in 200 mm



32-118

Side Cutting Forceps

CODE	DESCRIPTION	LENGTH
32-125	Tungsten Carbide	6 in 150 mm



Wire and Pin Cutters

Wire Cutting Pliers

Tungsten Carbide Jaws

CODE	DESCRIPTION	LENGTH
32-127	Angled, Max Capacity 1.6 mm	7 in 178 mm
32-128	Side Cutting, Max Capacity $\frac{3}{32}$ in	8½ in 215 mm
32-117-H	Max Capacity 2.5 mm	9 in 230 mm



32-127

Wire Cutting Pliers

Jaws Max Capacity $\frac{1}{16}$ in (2 mm)

CODE	DESCRIPTION	LENGTH
32-102	Tungsten Carbide	7½ in 180 mm



Wire Cutting Pliers

CODE	DESCRIPTION	LENGTH
56-2510	Stainless Steel	7 in 178 mm
32-3341	Tungsten Carbide Inserts	7 in 178 mm



56-2510

Wire Cutting Pliers

CODE	LENGTH
32-126	4¾ in 120 mm



Wire and Pin Cutters

Wire Cutting Scissors

CODE	DESCRIPTION	LENGTH
32-100	Tungsten Carbide	6¼ in 160 mm



Wire Twisters

Rubio Wire Twister

Snub Nose

CODE	DESCRIPTION	LENGTH
32-302	Jaws have Tungsten Carbide Inserts	5¼ in 135 mm



Ultra™ Wire Twister

CODE	DESCRIPTION	LENGTH
32-123	Jaws have Tungsten Carbide Inserts	6¾ in 171 mm



Wrenches

Spanner Wrench

CODE
80-1012





Scan the code above
to learn more about
our Urology portfolio.

Urology Portfolio



symmetry surgical™

Urology



Introduction	URO-2
Catheters & Guides	URO-3
Clamps	URO-4
Forceps, Retractors & Urethrotome Set	URO-5
Sounds	URO-6

Questions? Contact us at customerservice@symmetrysurgical.com
or learn more at symmetrysurgical.com



The Surgical Instrument Desk Reference

How to Use Our Catalog

The Symmetry Surgical catalog is designed with you in mind, to be your trusted resource for surgical instrumentation. We took great care in creating an easy-to-use, robust catalog and we think you'll be pleased with the design as you become more familiar with our broad portfolio.

Layout

The catalog is organized by surgical specialty *and* product function.

And we know that it is difficult to pick up an instrument and know what specialty it's listed in. To make your job easier, we've sorted the instruments in our portfolio by surgical function, too, including Energy, Laparoscopic, Retractors and Sterilization Solutions.

U.S. Customer Service

Your Symmetry Surgical Customer Service team wants to make ordering surgical instruments the easiest part of your day. We accept orders via phone, fax, email, our website, Global Healthcare Exchange (GHX) and through the mail.

PHONE

800.251.3000

(Available Monday through Friday, 8:30 AM–6:30 PM EST)

FAX

800.342.3272

EMAIL

customerservice@symmetrysurgical.com

ONLINE

symmetrysurgical.com

MAILING ADDRESS

Symmetry Surgical
Attn: Customer Service
3034 Owen Drive
Antioch, TN 37013

The Surgical Instrument Desk Reference

International Customer Service

PHONE

Symmetry Surgical Switzerland GmbH
+41 (0) 52 557 59 00
(Available Monday through Friday, 7:00-16:00 GMT)

Symmetry Surgical, Inc., USA
615.964.5672
(Available Monday through Friday, 8:30 AM-6:30 PM EST)

FAX

Symmetry Surgical Switzerland GmbH
+41 (0) 52 557 59 99

EMAIL

customerservice@symmetrysurgical.com
internationalorders@symmetrysurgical.com

ONLINE

symmetrysurgical.com

MAILING ADDRESS

Symmetry Surgical Switzerland GmbH
Bühlstrasse 27
CH-8200 Schaffhausen
Switzerland

Symmetry Surgical, Inc.
3034 Owen Drive
Antioch, TN 37013

INTERNATIONAL PAYMENT TERMS/RETURN GOODS POLICY/INSTRUMENT REPAIR & RESTORE PROGRAM/LITERATURE REQUESTS

Please contact your local distributor. Locate a local distributor contact, International Customer Service at +41 (0) 52 557 59 00 or 615.964.5672 (US).

Cardiovascular/Thoracic

Energy

Ear, Nose & Throat

General

Laparoscopic

Neurology

Obesity

OB/GYN

Ophthalmology

Orthopedics & Arthroscopy

Pediatrics

Rectal

Retractors

Spine

Urology

Sterilization Solutions

Alphabetical & Numeric Indexes

Introduction

Customer Service Hours of Operation

Symmetry Surgical's Customer Service team is happy to provide extended hours to support your organization's use of our surgical instruments.

Symmetry Surgical, Inc., USA

800.251.3000

Monday through Friday, from 8:30am to 6:30pm EST
customerservice@symmetrysurgical.com

Symmetry Surgical Switzerland GmbH

+41 (0) 52 557 59 00

Monday through Friday, 7:00 - 16:00 GMT
internationalorders@symmetrysurgical.com



The Making of a Surgical Instrument

Symmetry Surgical has a dedicated facility and team in Tuttlingen, Germany, the global center for high-quality surgical instrument manufacturers. The instruments are manufactured in conformance with proven processes that combine the latest technologies with the time-honored traditions that are the foundation of the craft of instrument manufacturing.

Well-trained and experienced surgical instrument makers produce the instruments by hand. Masters in their profession, instrument makers fine-tune each instrument before it is shipped to our inspection and receiving site, where each receives a thorough review for quality and fine craftsmanship.



FlashPak®

Symmetry Surgical's Flashpak® is the first name in immediate-use sterilization.

- Hospital-proven mobile sterile field
- Closed system
- Fully automatic operation
- Meets all standards for immediate-use sterilization
- Differentiated appearance meets AORN and AAMI standards



Catheters & Guides



51-7116

Female Catheter

CODE	DESCRIPTION	LENGTH	CODE	DESCRIPTION	LENGTH
51-7110	10 French	6 1/8 in 15.5 cm	51-7114	14 French	6 1/8 in 15.5 cm
51-7112	12 French	6 1/8 in 15.5 cm	51-7116	16 French	6 1/8 in 15.5 cm



29-3312

Walther Female Dilator-Catheter

CODE	DESCRIPTION	LENGTH	CODE	DESCRIPTION	LENGTH
29-3312	12 French	5 1/4 in 13.5 cm	29-3326	26 French	5 1/4 in 13.5 cm
29-3314	14 French	5 1/4 in 13.5 cm	29-3328	28 French	5 1/4 in 13.5 cm
29-3316	16 French	5 1/4 in 13.5 cm	29-3330	30 French	5 1/4 in 13.5 cm
29-3318	18 French	5 1/4 in 13.5 cm	29-3332	32 French	5 1/4 in 13.5 cm
29-3320	20 French	5 1/4 in 13.5 cm	29-3334	34 French	5 1/4 in 13.5 cm
29-3322	22 French	5 1/4 in 13.5 cm	29-3336	36 French	5 1/4 in 13.5 cm
29-3324	24 French	5 1/4 in 13.5 cm	29-3338	38 French	5 1/4 in 13.5 cm

Guyon Catheter Guide

CODE	DESCRIPTION
51-7530	9 French, Curved



Van Buren Catheter Guide

CODE	DESCRIPTION
51-7510	8 French, Straight



Clamps

Herrick Kidney Clamp

Double-Angled Jaws, Longitudinal Serrations

CODE	DESCRIPTION	LENGTH
51-5735	Kidney Clamp	9 in 23 cm



McDougal Prostatectomy Clamp

CODE	DESCRIPTION	LENGTH
51-5705	Left-Angled	10 in 25 cm
51-5706	Right-Angled	10 in 25 cm



51-5706

Wertheim-Cullen Kidney Clamp

Right-Angled Jaws, Longitudinal Serrations

CODE	DESCRIPTION	LENGTH
51-5775	Kidney Clamp	8½ in 21.5 cm



Zipser Penile Meatus Clamp

CODE	DESCRIPTION
51-9777	Penile Meatus Clamp

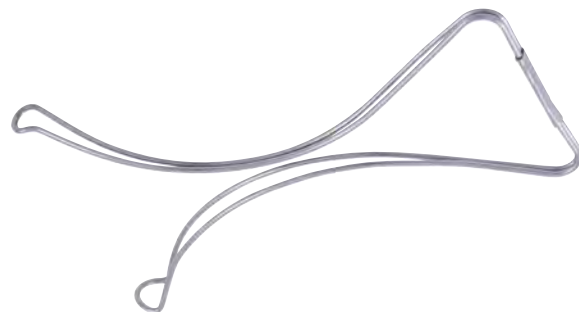

Forceps, Retractors & Urethrotome Sets

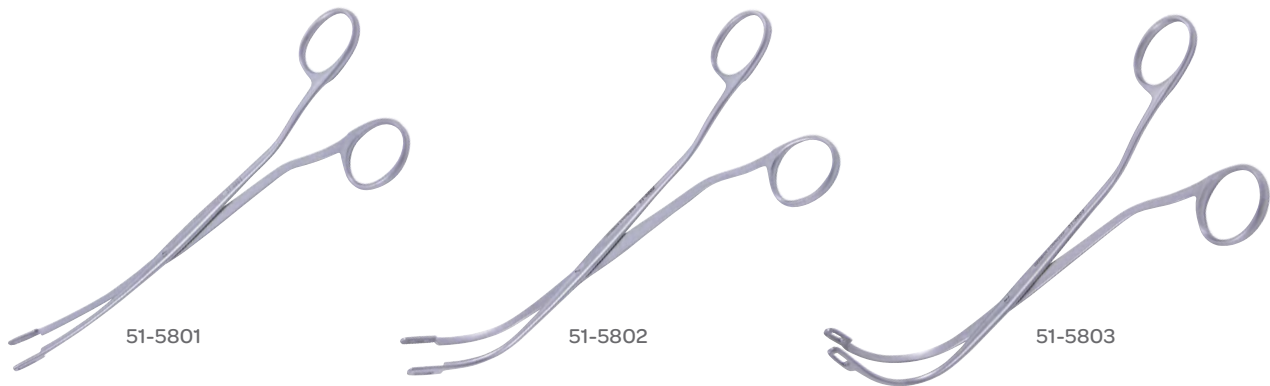

Randall Kidney Stone Forceps

CODE	DESCRIPTION	LENGTH	CODE	DESCRIPTION	LENGTH
51-5801	#1, Quarter Curve	9 in 23 cm	51-5803	#3, Three-Quarter Curve	9 in 23 cm
51-5802	#2, Half Curve	9 in 23 cm	51-5804	#4, Full Curve	9 in 23 cm



Gilvernet Renal Retractor

CODE	DESCRIPTION	LENGTH	CODE	DESCRIPTION	LENGTH
5150-A	9.0 mm	11¼ in 28.5 cm	5150-C	15 mm	11¼ in 28.5 cm
5150-B	11 mm	11¼ in 28.5 cm	5150-D	18 mm	11¼ in 28.5 cm

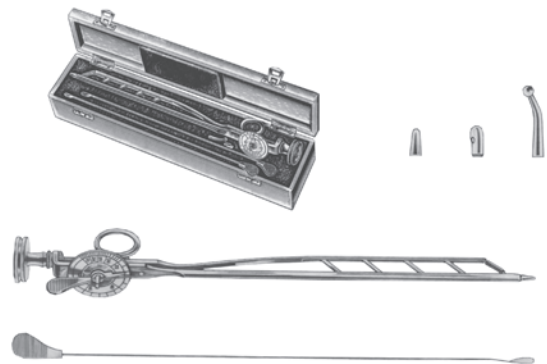

Otis Urethrotome Set, Straight

CODE	DESCRIPTION	CODE	DESCRIPTION
51-7902	Dilator Set	51-7905	Dilator Only
		51-7910	Blade Only

Sounds



51-7008

Lefort Urethral Sound

CODE	DESCRIPTION	LENGTH	CODE	DESCRIPTION	LENGTH
51-7008	8 French	11 in 28 cm	51-7020	20 French	11 in 28 cm
51-7010	10 French	11 in 28 cm	51-7022	22 French	11 in 28 cm
51-7012	12 French	11 in 28 cm	51-7024	24 French	11 in 28 cm
51-7014	14 French	11 in 28 cm	51-7026	26 French	11 in 28 cm
51-7016	16 French	11 in 28 cm	51-7028	28 French	11 in 28 cm
51-7018	18 French	11 in 28 cm	51-7030	30 French	11 in 28 cm



51-6808

McCrea Infant Urethral Sound, Curved

Plain Tip Also Used as Female Sounds

CODE	DESCRIPTION	LENGTH	CODE	DESCRIPTION	LENGTH
51-6808	8 French	7¼ in 18.5 cm	51-6824	24 French	7¼ in 18.5 cm
51-6810	10 French	7¼ in 18.5 cm	51-6826	26 French	7¼ in 18.5 cm
51-6812	12 French	7¼ in 18.5 cm	51-6828	28 French	7¼ in 18.5 cm
51-6814	14 French	7¼ in 18.5 cm	51-6830	30 French	7¼ in 18.5 cm
51-6816	16 French	7¼ in 18.5 cm	51-6832	32 French	7¼ in 18.5 cm
51-6818	18 French	7¼ in 18.5 cm	51-6834	34 French	7¼ in 18.5 cm
51-6820	20 French	7¼ in 18.5 cm	51-6836	36 French	7¼ in 18.5 cm
51-6822	22 French	7¼ in 18.5 cm			



51-6308

Van Buren Urethral Sound, Curved

CODE	DESCRIPTION	LENGTH	CODE	DESCRIPTION	LENGTH
51-6308	8 French	10¾ in 27 cm	51-6324	24 French	10¾ in 27 cm
51-6310	10 French	10¾ in 27 cm	51-6326	26 French	10¾ in 27 cm
51-6312	12 French	10¾ in 27 cm	51-6328	28 French	10¾ in 27 cm
51-6314	14 French	10¾ in 27 cm	51-6330	30 French	10¾ in 27 cm
51-6316	16 French	10¾ in 27 cm	51-6332	32 French	10¾ in 27 cm
51-6318	18 French	10¾ in 27 cm	51-6334	34 French	10¾ in 27 cm
51-6320	20 French	10¾ in 27 cm	51-6336	36 French	10¾ in 27 cm
51-6322	22 French	10¾ in 27 cm			

Sounds



51-6355



Van Buren Urethral Sound Set, Curved

CODE	DESCRIPTION	LENGTH	SET	CODE	DESCRIPTION	LENGTH	SET
51-6355	8–30 French	10 ¾ in 27 cm	12/Set	51-6350	14–24 French	10 ¾ in 27 cm	6/Set



29-1816

Walther Urethral Sound

CODE	DESCRIPTION	LENGTH	CODE	DESCRIPTION	LENGTH
29-1816	16 French	11 ¼ in 28.5 cm	29-1826	26 French	11 ¼ in 28.5 cm
29-1818	18 French	11 ¼ in 28.5 cm	29-1828	28 French	11 ¼ in 28.5 cm
29-1820	20 French	11 ¼ in 28.5 cm	29-1830	30 French	11 ¼ in 28.5 cm
29-1822	22 French	11 ¼ in 28.5 cm	29-1832	32 French	11 ¼ in 28.5 cm
29-1824	24 French	11 ¼ in 28.5 cm	29-1834	34 French	11 ¼ in 28.5 cm



Scan the code above to learn more about our Sterilization Solutions portfolio.

Sterilization Solutions Portfolio



symmetry surgical™

Sterilization Solutions



FlashPak®	SS-2
Quad-Lock® Sterilization Container	SS-4
Ultra™ Container System	SS-10
DentalPak	SS-17
EndoPak	SS-18
MicroPak	SS-19
MultiPak	SS-21
Quick Kit	SS-31
ScopePak	SS-33
StackPak	SS-35
TransPak	SS-36
Specialty Trays	SS-37
Sterilization Accessories	SS-45

Questions? Contact us at customerservice@symmetrysurgical.com
or learn more at symmetrysurgical.com



The Surgical Instrument Desk Reference

How to Use Our Catalog

The Symmetry Surgical catalog is designed with you in mind, to be your trusted resource for surgical instrumentation. We took great care in creating an easy-to-use, robust catalog and we think you'll be pleased with the design as you become more familiar with our broad portfolio.

Layout

The catalog is organized by surgical specialty *and* product function.

And we know that it is difficult to pick up an instrument and know what specialty it's listed in. To make your job easier, we've sorted the instruments in our portfolio by surgical function, too, including Energy, Laparoscopic, Retractors and Sterilization Solutions.

U.S. Customer Service

Your Symmetry Surgical Customer Service team wants to make ordering surgical instruments the easiest part of your day. We accept orders via phone, fax, email, our website, Global Healthcare Exchange (GHX) and through the mail.

PHONE

1.800.251.3000

(Available Monday through Friday, 8:30 AM–6:30 PM EST)

FAX

1.800.342.3272

EMAIL

customerservice@symmetrysurgical.com

ONLINE

symmetrysurgical.com

MAILING ADDRESS

Symmetry Surgical
Attn: Customer Service
3034 Owen Drive
Antioch, TN 37013

The Surgical Instrument Desk Reference

International Customer Service

PHONE

Symmetry Surgical Switzerland GmbH
+41 (0) 52 557 59 00
(Available Monday through Friday, 7:00-16:00 GMT)

Symmetry Surgical, Inc., USA
1.615.964.5672
(Available Monday through Friday, 8:30 AM–6:30 PM EST)

FAX

Symmetry Surgical Switzerland GmbH
+41 (0) 52 557 59 99

EMAIL

customerservice@symmetrysurgical.com
internationalorders@symmetrysurgical.com

ONLINE

symmetrysurgical.com

MAILING ADDRESS

Symmetry Surgical Switzerland GmbH
Bühlstrasse 27
CH-8200 Schaffhausen
Switzerland

Symmetry Surgical, Inc.
3034 Owen Drive
Antioch, TN 37013

INTERNATIONAL PAYMENT TERMS/RETURN GOODS POLICY/INSTRUMENT REPAIR & RESTORE PROGRAM/LITERATURE REQUESTS

Please contact your local distributor. Locate a local distributor contact, International Customer Service at +41 (0) 52 557 59 00 or 1.615.964.5672 (US).

Cardiovascular/Thoracic

Energy

Ear, Nose & Throat

General

Laparoscopic

Neurology

Obesity

OB/GYN

Ophthalmology

Orthopedics & Arthroscopy

Pediatrics

Rectal

Retractors

Spine

Urology

Sterilization Solutions

Alphabetical & Numeric Indexes

FlashPak®



FlashPak®

The FlashPak® is a hospital-proven, closed-container system engineered for safe transport of immediate-use steam sterilized (flashed) instruments in a mobile, sterile field. Advanced plastic polymer construction provides long term durability.

KEY BENEFITS:

- Validated and FDA cleared for use in both gravity and pre-vacuum cycles
- Accepts standard wire basket and a wide variety of trays to accommodate many types of instruments
- Transparent lid for quick identification
- Constructed of high-performance engineering polymers

FlashPak® Units (Includes Base, Lid & Basket)

CODE	SIZE	DIMENSIONS (INTERNAL)		DIMENSIONS (EXTERNAL)	
9020	Small	9 x 9 x 2 in	229 x 229 x 51 mm	11.5 x 11.2 x 7.3 in	292 x 284 x 185 mm
9030	Medium	9 x 18 x 3 in	229 x 457 x 76 mm	11.2 x 20.7 x 8.4 in	284 x 525 x 213 mm
9040	Large	9 x 22 x 3 in	229 x 559 x 76 mm	11 x 24.7 x 9 in	279 x 627 x 229 mm
9050	X-Large	10.5 x 21.25 x 3.5 in	266 x 539 x 89 mm	13 x 24.7 x 9 in	330 x 627 x 229 mm

Base Only

CODE	DESCRIPTION
9020-01	For Part 9020
9030-01	For Part 9030
9040-01	For Part 9040
9050-01	For Part 9050

Lid with Seal

CODE	DESCRIPTION
9020-02	For Part 9020
9030-02	For Part 9030
9040-02	For Part 9040
9050-02	For Part 9050

Please consult the product Instructions for Use, inserts and labels for specific information regarding intended use, contra-indications, warnings and cautions.

FlashPak®

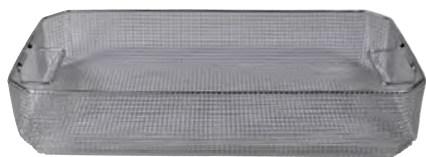

9050

Wire Basket

CODE	DESCRIPTION
9020-08	For Part Number 9020
9030-08	For Part Number 9030
9040-08	For Part Number 9040
9050-08	For Part Number 9050



9030-04

Silicone Pin Mat

CODE	DESCRIPTION
9020-04	For Part Number 9020-08
9030-04	For Part Number 9030-08
9040-04	For Part Number 9040-08
9050-04	For Part Number 9050-08



9030-13

Base Assembly

Includes Base, Pressure Balance Element and Gasket

CODE	DESCRIPTION
9020-13	For Part Number 9020
9030-13	For Part Number 9030
9040-13	For Part Number 9040
9050-13	For Part Number 9050

Note: Does not include valve



9111



9000-14

Accessories & Replacement Parts

CODE	DESCRIPTION
9000-14	Autoclave Gloves (One Pair)
9020-11	Pressure Balance Element, for All Bases
9020-12	Balance Element Gasket, for All Bases
9111	FlashPak® Delivery Cart, for All Sizes



Evolution Valve

CODE	DESCRIPTION
9090	Evolution Valve Change Kit, Includes Two Valves and Hardware Adapter Kit
9090-90	Evolution Valve Kit
9090-92	Eight Mounting Nuts
9090-93	Four Mounting Bolts

Please consult the product Instructions for Use, inserts and labels for specific information regarding intended use, contra-indications, warnings and cautions.

Questions? Contact us at customerservice@symmetrysurgical.com or learn more at symmetrysurgical.com

Quad-Lock® Sterilization Container

How to Choose the Right Quad-Lock® Container

1. Locate the instruments that will go inside the container and determine, based on the number, size and weight of instruments, what size basket is needed to hold these instruments.

NOTE: No instruments should sit above the inner edge of the basket.

2. Determine whether a **Solid Bottom Container Base** or **Filter Bottom Container Base** is appropriate based on the sterilization systems in use at your facility.

NOTE: To determine the height of the container base, add the height of the basket, plus 1 inch (25 mm) for the **Wire Base** (if used), plus 2 inches (50 mm) of clearance.

A wire base must be used with a **Filter Bottom Container Base**.

Filter Bottom Container Base Example:
2 inch (50 mm) Basket + 1 inch (25 mm) Wire Base + 2 inches (50 mm) clearance = 5 inches (127 mm).

Solid Bottom Container Base Example:
2 inch (50 mm) Basket + 2 inches (50 mm) clearance = 4 inches (101 mm).

3. Select a **Wire Base** the same length as the basket when using a Filter Base.
4. Consider a **Protective Mat** the same length as your basket, or upgrade to Accessory Instrument Organizers appropriate for your specific instrument set.
5. Add a **Filter Lid** in the color you prefer for each instrument set. Filter Lids are available in Gray, Yellow, Green, Blue, Red and Black.
6. Consider a **Security Lid** in the color you prefer for each instrument set. Security Lids are available in Gray, Yellow, Green, Blue, Red and Black.

See Product Information For Use for further details.



7. Consider **Ergonomic Hand Grips** in the color you prefer for each instrument set. Ergonomic Hand Grips are available in Gray, Yellow, Green, Blue, Red and Black.

8. Consider **Aluminum Nameplates** in the color you prefer for each instrument set. Aluminum Nameplates are available in Gray, Yellow, Green, Blue, Red and Black. Make note of what should be etched on each Aluminum Nameplate, up to a 45 character limit.

Don't Forget:

- Quad-Lock® Single-Use Filters
- Quad-Lock® Single-Use Paper Label with Indicator
- Quad-Lock® Single-Use Security Seals

Quad-Lock® Sterilization Container



Filter Bottom Container Base

CODE	DESCRIPTION	HEIGHT	
50-8731	Half Length	4 in	101 mm
50-8732	Half Length	5 in	127 mm
50-8733	Half Length	6 in	152 mm
50-8734	Half Length	8 in	203 mm
50-8735	Half Length	10 in	260 mm
50-8736	Three-Quarter Length	4 in	101 mm
50-8737	Three-Quarter Length	5 in	127 mm
50-8738	Three-Quarter Length	6 in	152 mm
50-8726	Full Length	4 in	101 mm
50-8727	Full Length	5 in	127 mm
50-8728	Full Length	6 in	152 mm
50-8729	Full Length	8 in	203 mm
50-8730	Full Length	10 in	260 mm
50-9044	Replacement Filter Retention Disc, qty 1		

Container Base Benefits

- Number of heights available to fit even your largest instrument set
- The oversized ergonomic handles have a 90° stop to protect fingers during transportation
- The container base has specially-designed feet for secure stacking and standard slots for large or small indicator cards or aluminum name plates
- All Filter Container Bases come fully equipped with Filter Retention Discs

Container Base Dimensions

BASE	DIMENSIONS (INTERNAL)	
Half Length	10.5 x 10.5 in	267 x 267 mm
Three-Quarter	17.5 x 10.5 in	444 x 267 mm
Full Length	22 x 11 in	559 x 279 mm

Solid Bottom Container Base

CODE	DESCRIPTION	HEIGHT	
50-8744	Half Length	4 in	101 mm
50-8745	Half Length	5 in	127 mm
50-8746	Half Length	6 in	152 mm
50-8747	Half Length	8 in	203 mm
50-8748	Half Length	10 in	254 mm
50-8749	Three-Quarter Length	4 in	101 mm
50-8750	Three-Quarter Length	5 in	127 mm
50-8751	Three-Quarter Length	6 in	152 mm
50-8739	Full Length	4 in	101 mm
50-8740	Full Length	5 in	127 mm
50-8741	Full Length	6 in	152 mm
50-8742	Full Length	8 in	203 mm
50-8743	Full Length	10 in	254 mm

Please consult the product Instructions for Use, inserts and labels for specific information regarding intended use, contra-indications, warnings and cautions.

Questions? Contact us at customerservice@symmetrysurgical.com or learn more at symmetrysurgical.com

Quad-Lock® Sterilization Container

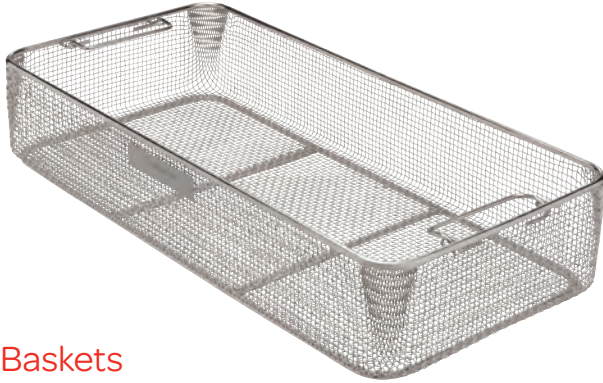

- Sturdy lightweight holders for your instrument sets
- Available in a number of sizes
- Designed with handles that feature a 90° stop for easy access
- Handles can also slide neatly out of the way for easy instrument access

Baskets

CODE	DESCRIPTION	DIMENSIONS		HEIGHT	
50-8504	Half Length	9 7/8 x 9 7/8 in	250 x 250 mm	1 in	25 mm
50-8505	Half Length	9 7/8 x 9 7/8 in	250 x 250 mm	2 in	50 mm
50-8506	Half Length	9 7/8 x 9 7/8 in	250 x 250 mm	3 in	76 mm
50-8507	Half Length	9 7/8 x 9 7/8 in	250 x 250 mm	4 in	101 mm
50-8508	Three-Quarter Length	16 x 9 7/8 in	405 x 250 mm	1 in	25 mm
50-8509	Three-Quarter Length	16 x 9 7/8 in	405 x 250 mm	2 in	50 mm
50-8510	Three-Quarter Length	16 x 9 7/8 in	405 x 250 mm	3 in	76 mm
50-8511	Three-Quarter Length	16 x 9 7/8 in	405 x 250 mm	4 in	101 mm
50-8500	Full Length	21 1/4 x 9 7/8 in	540 x 250 mm	1 in	25 mm
50-8501	Full Length	21 1/4 x 9 7/8 in	540 x 250 mm	2 in	50 mm
50-8502	Full Length	21 1/4 x 9 7/8 in	540 x 250 mm	3 in	76 mm
50-8503	Full Length	21 1/4 x 9 7/8 in	540 x 250 mm	4 in	101 mm



- Designed to prevent instruments, silicone mats and baskets from touching the bottom of the container. Wire base required for proper air displacement and sterilant penetration when using filtered container base
- A Wire Base must be used with every Container Base that has filters on the bottom

Wire Base

CODE	DESCRIPTION	SIZE	
50-8514	Full Length	1 in	25 mm
50-8513	Three-Quarter Length	1 in	25 mm
50-8512	Half Length	1 in	25 mm

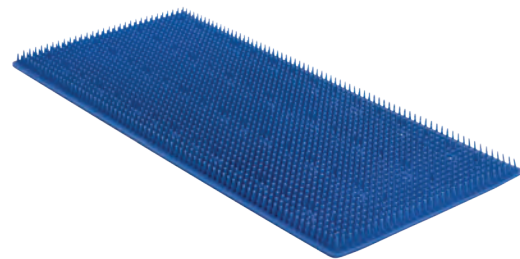

- Helps protect the most delicate instruments
- Pair a Protective Silicone Pin Mat with a Wire Base or Basket and you can place large objects directly in the Container Base without using a Basket
- Only available in blue

Silicone Pin Mats

CODE	DESCRIPTION
50-8550	Half Length
50-8551	Three-Quarter Length
50-8552	Full Length

Please consult the product Instructions for Use, inserts and labels for specific information regarding intended use, contra-indications, warnings and cautions.

Questions? Contact us at customerservice@symmetrysurgical.com or learn more at symmetrysurgical.com

Quad-Lock® Sterilization Container



- Advanced, unique Quad-Lock® design for reliable lid attachment
- Four-latch lids available in six colors feature a specially molded design to avoid warping without adding weight
- Deep-seated grooves for secure stacking

Lid colors available include: Gray, Yellow, Green, Blue, Red and Black



Filter Lids

DESCRIPTION	GRAY	YELLOW	GREEN	BLUE	RED	BLACK
Half Length	50-8950	50-8951	50-8952	50-8953	50-8954	50-8955
Three-Quarter Length	50-8956	50-8957	50-8958	50-8959	50-8960	50-8961
Full Length	50-8944	50-8945	50-8946	50-8947	50-8948	50-8949
Replacement Filter Retention Disc, QTY 1 ea						
CODE	DESCRIPTION					QTY
50-9044	Replacement Filter Retention Disc					1



- Provides an additional layer of protection for the filter
- Self-attaching 'drop on' latches, deep-seated grooves for secure stacking
- Made of anodized aluminum for lightweight durability

Lid colors available include: Gray, Yellow, Green, Blue, Red and Black



Security Lids

DESCRIPTION	GRAY	YELLOW	GREEN	BLUE	RED	BLACK
Half Length	50-8875	50-8876	50-8877	50-8878	50-8879	50-8880
Three-Quarter Length	50-8881	50-8882	50-8883	50-8884	50-8885	50-8886
Full Length	50-8869	50-8870	50-8871	50-8872	50-8873	50-8874

Please consult the product Instructions for Use, inserts and labels for specific information regarding intended use, contra-indications, warnings and cautions.

Questions? Contact us at customerservice@symmetrysurgical.com or learn more at symmetrysurgical.com

Quad-Lock® Sterilization Container



Ergonomic Hand Grip

- Provides protection from excess heat, which can be a safety risk following sterile processing
- Available in six colors (shown below)

Aluminum Nameplates

- Etched to your specific needs, with a limit of 45 characters
- Made of anodized aluminum for lightweight durability

Single-Use Products

- Clearly-labeled round filters, small and large indicator cards all include a sterility indicator

Colors available include: Gray, Yellow, Green, Blue, Red and Black



Ergonomic Silicone Hand Grips

DESCRIPTION	GRAY	YELLOW	GREEN	BLUE	RED	BLACK
Ergonomic Silicone Hand Grips (Pair)	50-9016	50-9015	50-9014	50-9013	50-9012	50-9017

Aluminum Nameplate

DESCRIPTION	GRAY	YELLOW	GREEN	BLUE	RED	BLACK
Aluminum Nameplate (1 Each)	50-9004	50-9003	50-9002	50-9001	50-9000	50-9005

Single-Use Products

CODE	DESCRIPTION	QTY
50-9006	Paper Label with Indicator Small	250
50-9007	Paper Label with Indicator Large	250
50-9008	Security Seal, Blue (Single-Use Only)	100
50-9010	Filter (Single-Use Only)	1000

Please consult the product Instructions for Use, inserts and labels for specific information regarding intended use, contra-indications, warnings and cautions.

Questions? Contact us at customerservice@symmetrysurgical.com or learn more at symmetrysurgical.com

Quad-Lock® Sterilization Container

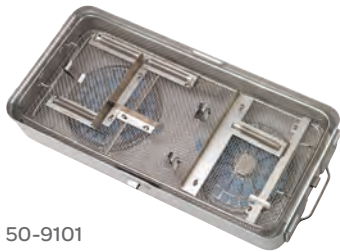

50-9101

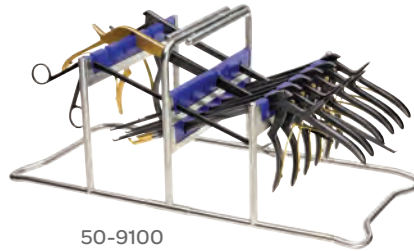

























50-9100



50-9041

Accessories

ITEM	CODE	DESCRIPTION	SIZE	
	50-9018	Holding Pin for Divider, Use with 509026–509029		
	50-9019	Holding Pin for Instruments	1 in	25 mm
	50-9020	Basket Handle Tag		
	50-9021	Spring Clip	¼–½ in	7.0–12 mm
	50-9022	Spring Clip	½–¾ in	12–19 mm
	50-9023	Spring Clip	¾–1 in	19–25 mm
	50-9024	Spring Clip	1–1½ in	25–38 mm
	50-9025	Spring Clip	1½–1¾ in	38–45 mm
	50-9026	Divider, Use with two 50-9018	2 x ¾ in	50 x 19 mm
	50-9027	Divider, Use with two 50-9018	5 x ¾ in	127 x 19 mm
	50-9028	Divider, Use with two 50-9018	9 x ¾ in	228 x 19 mm
	50-9029	Divider, Use with two 50-9018	18 x ¾ in	457 x 19 mm
	50-9030	Polymer Spacer, Use with 50-9031 and 50-9032	1½ x ⅝ in	38 x 16 mm
	50-9031	Sliding Rail for Polymer Spacer, Use with 50-9030		
	50-9032	Sliding Rail for Polymer Spacer, Use with 50-9030	18½ in	470 mm
	50-9033	Limiting Bar, Screws to Basket	9 in	228 mm
	50-9034	Limiting Bar, Screws to Basket	18½ in	470 mm
	50-9035	Double Spiral Holding Device, Screws to Basket	9 in	228 mm
	50-9036	Single Spiral Holding Device, Screws to Basket	5 in	127 mm
	50-9037	Limiting Bar Right Angle, Screws to Basket	4½ in	110 mm
	50-9038	Limiting Bar Right Angle, Screws to Basket	6½ in	170 mm
	50-9039	Limiting Bar Right Angle, Screws to Basket	9 in	228 mm
	50-9040	Limiting Bar Right Angle, Screws to Basket	18½ in	470 mm
(Shown above)	50-9041	Spiral Divider with Limiting Bar	5 x 9 in	127 x 228 mm
	50-9042	Double Spiral Divider, Use with 50-9018	9 in	228 mm
	50-9043	Spiral Divider Single, Use with 50-9018	5 in	127 mm
(Shown above)	50-9101	Universal Rongeur Instrument Holder	Half Size Basket	
(Shown above)	50-9100	Universal Rongeur Instrument Holder	Full Size Basket	

Please consult the product Instructions for Use, inserts and labels for specific information regarding intended use, contra-indications, warnings and cautions.

Questions? Contact us at customerservice@symmetrysurgical.com or learn more at symmetrysurgical.com

Ultra™ Container System



C18135

Ultra™ Container System

The lightweight Ultra™ Container System helps keep heavy instrument sets within AORN and AAMI limits. Designed for durability, it weighs 30% less than comparable sterilization systems.

KEY BENEFITS:

- Extruded rails reinforce the base and lid rims
- 13 inch (330 mm) width provides acceptable packaging for most loaner instrumentation trays
- Five sizes accommodate both general and specialty instruments

Prevac Base & Lid

CODE	DESCRIPTION	DIMENSIONS	
C13854	Quarter Length	13 x 8.5 x 4 in	330 x 216 x 101 mm
C13855	Quarter Length	13 x 8.5 x 5 in	330 x 216 x 127 mm
C13856	Quarter Length	13 x 8.5 x 6 in	330 x 216 x 152 mm
C13134	Half Length	13 x 13 x 4 in	330 x 330 x 101 mm
C13135	Half Length	13 x 13 x 5 in	330 x 330 x 127 mm
C13136	Half Length	13 x 13 x 6 in	330 x 330 x 152 mm
C18134	Three-Quarter Length	18 x 13 x 4 in	457 x 330 x 101 mm
C18135	Three-Quarter Length	18 x 13 x 5 in	457 x 330 x 127 mm
C18136	Three-Quarter Length	18 x 13 x 6 in	457 x 330 x 152 mm
C18138	Three-Quarter Length	18 x 13 x 8 in	457 x 330 x 203 mm
C181310	Three-Quarter Length	18 x 13 x 10 in	457 x 330 x 254 mm
C22854	Endoscopic Length	22 x 8.5 x 4 in	559 x 216 x 101 mm
C22855	Endoscopic Length	22 x 8.5 x 5 in	559 x 216 x 127 mm
C22856	Endoscopic Length	22 x 8.5 x 6 in	559 x 216 x 152 mm
C22858	Endoscopic Length	22 x 8.5 x 8 in	559 x 216 x 203 mm
C24134	Full Length	24 x 12 x 4 in	610 x 305 x 101 mm
C24135	Full Length	24 x 12 x 5 in	610 x 305 x 127 mm
C24136	Full Length	24 x 12 x 6 in	610 x 305 x 152 mm
C24138	Full Length	24 x 12 x 8 in	610 x 305 x 203 mm

Please consult the product Instructions for Use, inserts and labels for specific information regarding intended use, contra-indications, warnings and cautions.

Ultra™ Container System



Gravity Base & Lid

CODE	DESCRIPTION	DIMENSIONS	
C13856-G	Quarter Length	13 x 8.5 x 6 in	330 x 216 x 152 mm
C13136-G	Quarter Length	13 x 13 x 6 in	330 x 330 x 152 mm
C18136-G	Three-Quarter Length	18 x 13 x 6 in	457 x 330 x 152 mm
C181310-G	Three-Quarter Length	18 x 13 x 10 in	457 x 330 x 254 mm
C24136-G	Full Length	24 x 12 x 6 in	610 x 305 x 152 mm
C24138-G	Full Length	24 x 12 x 8 in	610 x 305 x 203 mm



B2175

Prevac/Gravity Aluminum Basket

CODE	DESCRIPTION	DIMENSIONS	
B12751	Quarter Length	12 x 7.5 x 1.4 in	305 x 190 x 36 mm
B12752	Quarter Length	12 x 7.5 x 2 in	305 x 190 x 50 mm
B12753	Quarter Length	12 x 7.5 x 3 in	305 x 190 x 76 mm
B12754	Quarter Length	12 x 7.5 x 4 in	305 x 190 x 101 mm
B12121	Half Length	12 x 12 x 1.4 in	305 x 305 x 36 mm
B12122	Half Length	12 x 12 x 2 in	305 x 305 x 50 mm
B12123	Half Length	12 x 12 x 3 in	305 x 305 x 76 mm
B12124	Half Length	12 x 12 x 4 in	305 x 305 x 101 mm
B17121	Three-Quarter Length	17 x 12 x 1.4 in	432 x 305 x 36 mm
B17122	Three-Quarter Length	17 x 12 x 2 in	432 x 305 x 50 mm
B17123	Three-Quarter Length	17 x 12 x 3 in	432 x 305 x 76 mm
B17124	Three-Quarter Length	17 x 12 x 4 in	432 x 305 x 101 mm
B21751	Endoscopic Length	21 x 7.5 x 1.4 in	533 x 190 x 36 mm
B21752	Endoscopic Length	21 x 7.5 x 2 in	533 x 190 x 50 mm
B21753	Endoscopic Length	21 x 7.5 x 3 in	533 x 190 x 76 mm
B21754	Endoscopic Length	21 x 7.5 x 4 in	533 x 190 x 101 mm
B23121	Full Length	23 x 12 x 1.4 in	584 x 305 x 36 mm
B23122	Full Length	23 x 12 x 2 in	584 x 305 x 50 mm
B23123	Full Length	23 x 12 x 3 in	584 x 305 x 76 mm
B23124	Full Length	23 x 12 x 4 in	584 x 305 x 101 mm

Please consult the product Instructions for Use, inserts and labels for specific information regarding intended use, contra-indications, warnings and cautions.

Questions? Contact us at customerservice@symmetrysurgical.com or learn more at symmetrysurgical.com

Ultra™ Container System



C13854-SP



C22856-S

Sterrad Base & Lid

CODE	DESCRIPTION	DIMENSIONS	
C13854-SP	Quarter Length	13 x 8.5 x 4 in	330 x 215 x 101 mm
C13855-SP	Quarter Length	13 x 8.5 x 5 in	330 x 215 x 127 mm
C13856-SP	Quarter Length	13 x 8.5 x 6 in	330 x 215 x 152 mm
C13134-SP	Half Length	13 x 13 x 4 in	330 x 330 x 101 mm
C13135-SP	Half Length	13 x 13 x 5 in	330 x 330 x 127 mm
C13136-SP	Half Length	13 x 13 x 6 in	330 x 330 x 152 mm
C18134-SP	Three-Quarter Length	18 x 13 x 4 in	457 x 330 x 101 mm
C18135-SP	Three-Quarter Length	18 x 13 x 5 in	457 x 330 x 127 mm
C18136-SP	Three-Quarter Length	18 x 13 x 6 in	457 x 330 x 152 mm
C22854-SP	Endoscopic Length	22 x 8.5 x 4 in	558 x 215 x 101 mm
C22856-SP	Endoscopic Length	22 x 8.5 x 6 in	558 x 215 x 152 mm
C24134-SP	Full Length	24 x 12 x 4 in	609 x 304 x 101 mm
C24138-SP	Full Length	24 x 12 x 8 in	609 x 304 x 203 mm



B23122-SS

Sterrad Basket

CODE	DESCRIPTION	DIMENSIONS	
B12752-SS	Quarter Length	12 x 7.5 x 2 in	304 x 190 x 50 mm
B12753-SS	Quarter Length	12 x 7.5 x 3 in	304 x 190 x 76 mm
B12754-SS	Quarter Length	12 x 7.5 x 4 in	304 x 190 x 101 mm
B12122-SS	Half Length	12 x 12 x 2 in	304 x 304 x 50 mm
B12123-SS	Half Length	12 x 12 x 3 in	304 x 304 x 76 mm
B12124-SS	Half Length	12 x 12 x 4 in	304 x 304 x 101 mm
B17122-SS	Three-Quarter Length	17 x 12 x 2 in	431 x 304 x 50 mm
B17123-SS	Three-Quarter Length	17 x 12 x 3 in	431 x 304 x 76 mm
B17124-SS	Three-Quarter Length	17 x 12 x 4 in	431 x 304 x 101 mm
B21754-SS	Endoscopic Length	21 x 7.5 x 4 in	533 x 190 x 101 mm
B23122-SS	Full Length	23 x 12 x 2 in	584 x 304 x 50 mm
B23123-SS	Full Length	23 x 12 x 3 in	584 x 304 x 76 mm
B23124-SS	Full Length	23 x 12 x 4 in	584 x 304 x 101 mm

Please consult the product Instructions for Use, inserts and labels for specific information regarding intended use, contra-indications, warnings and cautions.

Ultra™ Container System

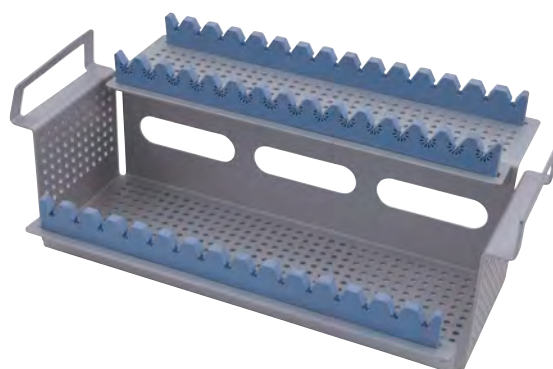

STERILIZATION

Arthroscopy Rack

CODE	DESCRIPTION	HOLDS
ARTH-RACK	For use with B-SHUTT	15 Instruments



Arthroscopy Tray

CODE	DESCRIPTION	DIMENSIONS
B-SHUTT	For use with C18138	17 x 12 x 6 in 432 x 305 x 152 mm



Half Length Drill Tray

CODE	DESCRIPTION	DIMENSIONS
B1212-DRILL	Drill Tray	12 x 12 x 2 in 305 x 305 x 305 mm

Please consult the product Instructions for Use, inserts and labels for specific information regarding intended use, contra-indications, warnings and cautions.

Questions? Contact us at customerservice@symmetrysurgical.com or learn more at symmetrysurgical.com

Ultra™ Container System

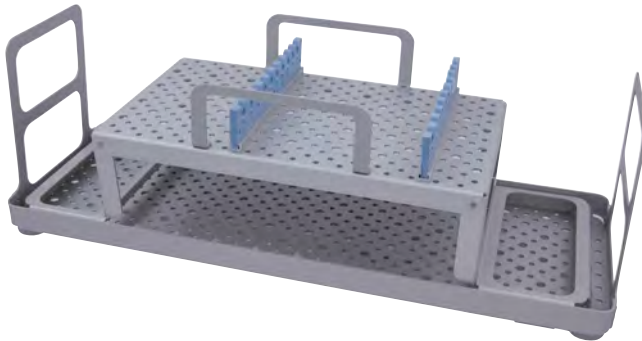

B2175-LAP

Large Laparoscopic Insert

CODE	DESCRIPTION	HOLDS	DIMENSIONS	
B2175-LAP	Small Insert, For use with C22858	10 Instruments	21 x 7½ x 6 in	533 x 190 x 152 mm
B2312-LAP	Large Insert, For use with C24138	15 Instruments	23 x 12 x 6 in	584 x 305 x 152 mm

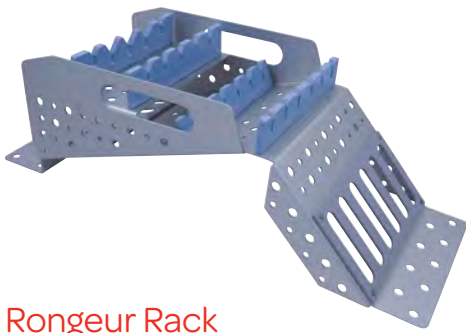

Rongeur Rack

CODE	DESCRIPTION
B2175-RONGEUR	For Endoscopic Container C22856

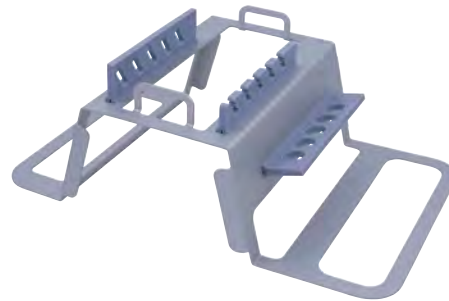

Small Rongeur Rack

CODE	DESCRIPTION
B-1275R	Small Rongeur Rack



FL-5



RP-OVAL



FL-11-100



RP-ROUND

Filters

CODE	DESCRIPTION	CONTAINER	QTY
FL5-100	Single-Use Oval Filter	For Quarter and Endoscopic Length Containers	100/Box
FL-5	Single-Use Oval Filter	For Quarter and Endoscopic Length Containers	1000/Box
RP-OVAL	Oval Retention Plate	For Quarter and Endoscopic Length Containers	
FL11-100	Single-Use Round Filter	For Half, Three-Quarter and Full Length Containers	100/Box
FL-11	Single-Use Round Filter	For Half, Three-Quarter and Full Length Containers	1000/Box
RP-ROUND	Round Retention Plate	For Half, Three-Quarter and Full Length Containers	

Please consult the product Instructions for Use, inserts and labels for specific information regarding intended use, contra-indications, warnings and cautions.

Ultra™ Container System

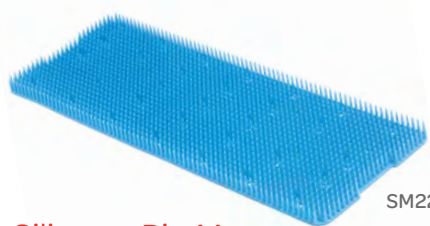

SM225115

Silicone Pin Mat

CODE	DESCRIPTION	CONTAINER
SM11570	Silicone Pin Mat	For Quarter Length Baskets
SM115115	Silicone Pin Mat	For Half Length Baskets
SM165115	Silicone Pin Mat	For Three-Quarter Length Baskets
SM225115	Silicone Pin Mat	For Full Length Baskets



1013-1-006

Gasket

CODE	DESCRIPTION	CONTAINER
1013-1-005	Silicone Foam Replacement Gasket	For Quarter Length Container
1013-1-003	Silicone Foam Replacement Gasket	For Half Length Container
1013-1-004	Silicone Foam Replacement Gasket	For Three-Quarter Length Container
1013-1-006	Silicone Foam Replacement Gasket	For Endoscopic Length Container
1013-1-002	Silicone Foam Replacement Gasket	For Full Length Container



2001

Locks

CODE	DESCRIPTION	CONTAINER	QTY
2001	Ultra™ Container Safe-Lock Key	For Steam and ETO	500/Pk
2001-SP	Ultra™ Container Safe-Lock Key	For Sterrad	500/Pk

Aluminum Name Plate











BLACK	BLUE	GREEN	PURPLE	RED	GOLD
Tag-Black	Tag-Blue	Tag-Green	Tag-Purple	Tag-Red	Tag-Gold

Please consult the product Instructions for Use, inserts and labels for specific information regarding intended use, contra-indications, warnings and cautions.

Questions? Contact us at customerservice@symmetrysurgical.com or learn more at symmetrysurgical.com

Ultra™ Container System

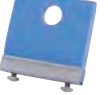
Accessories

ITEM	CODE	DESCRIPTION	SIZE
	DC15	Curved Divider	1.5 x 3.2 in 38 x 81 mm
	DC25	Curved Divider	2.5 x 3.2 in 63 x 81 mm
	DL15	Long Straight Divider	1.5 x 11.2 in 38 x 284 mm
	DL25	Long Straight Divider	2.5 x 11.2 in 63 x 284 mm
	DS15	Short Divider	1.5 x 5.8 in 38 x 147 mm
	DS25	Short Divider	2.5 x 5.8 in 63 x 147 mm
	KB1	Keyhole Bracket	3.0 mm, 1.5 in Silicone
	KB2	Keyhole Bracket	3.0 mm, 1 in Silicone
	KB3	Keyhole Bracket	5.0 mm, 1.5 in Silicone
	KB4	Keyhole Bracket	5.0 mm, 1 in Silicone
	KB5	Keyhole Bracket	7.0 mm, 1.5 in Silicone
	KB6	Keyhole Bracket	7.0 mm, 1 in Silicone
	KB7	Keyhole Bracket	10 mm, 1.5 in Silicone
	KB8	Keyhole Bracket	10 mm, 1 in Silicone
	KB9	Keyhole Bracket	12 mm, 1.5 in Silicone
	KB10	Keyhole Bracket	12 mm, 1 in Silicone
	KB11	Keyhole Bracket	13 mm, 1.5 in Silicone
	KB13	Keyhole Bracket	19 mm, 1.5 in Silicone
	KB15	Keyhole Bracket	22 mm, 1.5 in Silicone
	KB16	Keyhole Bracket	25 mm, 1.5 in Silicone
	P10	Stainless Holding Pin	0.25 x 0.75 in 6 x 19 mm
	P15	Stainless Holding Pin	0.25 x 1.5 in 6 x 38 mm
	P25	Stainless Holding Pin	0.25 x 2.5 in 6 x 63 mm
	P35	Stainless Holding Pin	0.25 x 3.5 in 6 x 89 mm
	SB10	Instrument Bracket	10 in Silicone
	SB5	Instrument Bracket	5 in Silicone
	SB7	Instrument Bracket	7 in Silicone

Please consult the product Instructions for Use, inserts and labels for specific information regarding intended use, contra-indications, warnings and cautions.

DentalPak



DentalPak

The multifunctional Instrument Cassettes accommodate a wide array of delicate instruments.

KEY BENEFITS:

- Unique hinged lid design provides easy use
- Silicone strips can accommodate instruments with diameters ranging from 2.5 to 8.0 mm
- Silicone mats gently secure instruments
- Unique raised silicone (latex free) mats provide efficient ventilation to facilitate drying
- Economical, durable and functional

DentalPak Instrument Cassettes

CODE	DESCRIPTION	DIMENSIONS (INTERNAL)	
7-1200	12 Position Slotted Instrument Cassette	8 x 4.5 x 1.2 in	203 x 114 x 30 mm
7-6000	6 Position Slotted Instrument Cassette	8 x 4.5 x 0.61 in	203 x 114 x 15 mm

DentalPak Instrument Cassettes with Silicone Mat

CODE	DESCRIPTION	DIMENSIONS (INTERNAL)	
7-1250	Deep Instrument Cassette with Silicone Mat	8 x 4.5 x 1.2 in	203 x 114 x 30 mm
7-6050	Shallow Instrument Cassette with Silicone Mat	8 x 4.5 x 0.61 in	203 x 114 x 15 mm

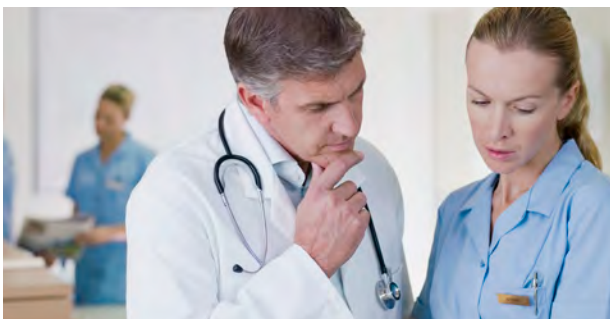

Enduring Clinical Support

Our commitment to customers includes a collaborative approach to finding and developing solutions to help them overcome industry challenges.

Through reliable and relevant clinical support, we assist our customers in identifying and solving problems they face in their clinical practice. We pride ourselves on exceeding their expectations while providing the best solution possible.

Please consult the product Instructions for Use, inserts and labels for specific information regarding intended use, contra-indications, warnings and cautions.

Questions? Contact us at customerservice@symmetrysurgical.com or learn more at symmetrysurgical.com

EndoPak

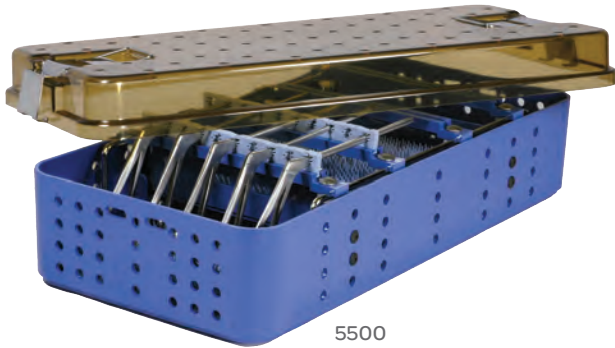

5500

26 Inch Endoscopic Kit*

CODE	DESCRIPTION	QTY
7726	26 in Endoscopic Kit Includes:	
7026	Aluminum Base/Polymer Lid	1/Kit
7513X	Wire Rack	1/Kit
7200X	Bar Holders	2/Kit

*Instruments and silicone parts are not included

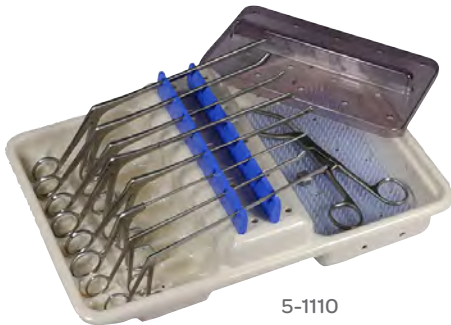

5-1110

EndoPak

EndoPak provides a convenient means of organizing laparoscopy and arthroscopy instruments. Some instruments used in other endoscopic specialties are also compatible.

Choose from modular Endoscopic Kits or specialized laparoscopy and arthroscopy trays designed to hold standard size instruments. The comprehensive product offering includes trays to meet most user needs.

20 Inch Endoscopic Kit*

CODE	DESCRIPTION	QTY
5500	20 in Endoscopic Kit Includes:	
5000-01-475P	Base	1/Kit
5000-50-175P	Lid	1/Kit
5111	Wire Rack	1/Kit
5022	Insert Tray	1/Kit
5200S	Bar Holders	4/Kit
5233	"T" Brackets, and Hardware Insert Tray	4/Kit

*Instruments and silicone parts are not included

EndoPak Arthroscopy Cases

CODE	DESCRIPTION	DIMENSIONS (INTERNAL)	
5-1150	Modular Handheld Instrument Case	18.25 x 7.5 x 2.75 in	464 x 190 x 70 mm
5-1110	Universal Handheld Case and Lid	13.5 x 8.8 x 2.5 in	343 x 224 x 64 mm

EndoPak Laparoscopy Cases

CODE	DESCRIPTION	DIMENSIONS (INTERNAL)	
4-1130	Convertible LapCare Case	18.8 x 8 x 5.1 in	478 x 203 x 130 mm
4-1146	Insert Cassette	8.2 x 2.7 x 0.76 in	209 x 69 x 19 mm
4-1200	Large Modular LapCare Case	25.8 x 9.4 x 6.9 in	657 x 239 x 176 mm
4-1210	Standard Modular LapCare Case	20.9 x 9.8 x 6.9 in	531 x 250 x 176 mm
4-2000	Conventional LapCare Case	20.6 x 9.8 x 3.9 in	523 x 249 x 101 mm
43200	Extra-Long LapCare Case	24.7 x 11.7 x 5.1 in	627 x 297 x 137 mm

Please consult the product Instructions for Use, inserts and labels for specific information regarding intended use, contra-indications, warnings and cautions.

Questions? Contact us at customerservice@symmetrysurgical.com or learn more at symmetrysurgical.com

MicroPak Classic Series

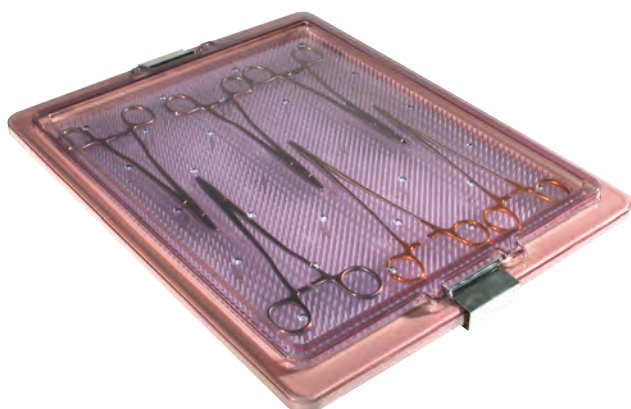

MicroPak Classic Series

The MicroPak Classic Series provides a simple and convenient solution to the organization, sterilization, and transportation of microsurgical instrument sets while providing a high level of protection.

KEY BENEFITS:

- Provides maximum protection as well as ease of fixation for a variety of instruments
- Withstands repeated steam autoclave and ETO sterilization

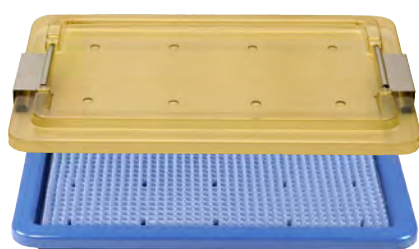

0105 Base, Lid & Mat



0207 Base, Lid, Insert Tray & Mat

MicroPak Classic Series I: Base, Lid & Mat

CODE	DIMENSIONS (INTERNAL)	
0105	9.6 x 5.5 x 0.7 in	244 x 140 x 18 mm
0116	12.8 x 7.3 x 0.7 in	325 x 185 x 18 mm
0119	18 x 10.3 x 0.7 in	457 x 262 x 18 mm
6-1400	11.7 x 14.5 x 0.7 in	298 x 368 x 18 mm
6-1800	10.3 x 18.3 x 2.3 in	262 x 465 x 59 mm
6-8700	8.2 x 17.3 x 0.6 in	210 x 439 x 16 mm

MicroPak Classic Series II: Base, Lid Insert Tray & Mat

CODE	DIMENSIONS (INTERNAL)	
0207	9.6 x 5.5 x 0.7 in	244 x 140 x 18 mm
0212	12.8 x 7.3 x 0.7 in	325 x 185 x 18 mm
0217	18 x 10.3 x 0.7 in	457 x 262 x 18 mm
0220	17.8 x 9.7 x 1½ in	452 x 246 x 38 mm
6-1100	13.4 x 8.4 x 2 in	341 x 214 x 51 mm

Please consult the product Instructions for Use, inserts and labels for specific information regarding intended use, contra-indications, warnings and cautions.

Questions? Contact us at customerservice@symmetrysurgical.com or learn more at symmetrysurgical.com

MicroPak



0103 Base, Lid & Mat

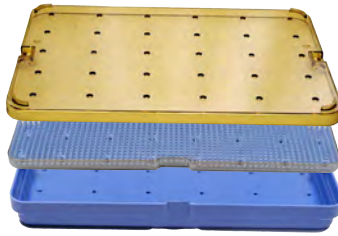

2023 Base, Lid, Insert Tray & Mat

MicroPak Base, Lid & Mat

CODE	DIMENSIONS (INTERNAL)		CODE	DIMENSIONS (INTERNAL)	
0101	1.6x2.6x0.5 in	40x66x13 mm	1025	6x10x1.5 in	152x254x38 mm
0103	2.9x7.8x0.7 in	74x198x18 mm	1-2700	7.12x1.92x0.73 in	181x49x19 mm
0111	2x6x0.8 in	50x152x19 mm	1-3700	7.10x2.86x0.73 in	180x73x19 mm
0211	3x6x0.8 in	76x152x19 mm	1-4800	7.5x4x0.75 in	190x102x19 mm
1011	6x10x0.8 in	152x254x19 mm	2011	10x15x0.8 in	254x381x19 mm
1015	5.5x9.5x2.5 in	140x241x64 mm	2025	10x15x1.5 in	254x381x38 mm

MicroPak Base, Lid, Insert Tray & Mat

CODE	DESCRIPTION	DIMENSIONS (INTERNAL)	
1021	Base, Lid, Insert Tray and 2 Insert Mats	6x10x1.5 in	152x254x38 mm
1023	Base, Lid, Insert Tray and 1 Insert Mat	6x10x1.5 in	152x254x38 mm
2021	Base, Lid, Insert Tray and 2 Mats	10x15x1.5 in	254x381x38 mm
2023	Base, Lid, Insert Tray and 1 Mat	10x15x1.5 in	254x381x38 mm
2024	Base, Lid, ½ Insert Tray and 2 Insert Mats	6x10x1.5 in	152x254x38 mm

MicroPak Base, Lid, Insert Tray & Mat

CODE	DESCRIPTION	DIMENSIONS (INTERNAL)	
1-2710	Diamond Knife Base and Lid with 2 Silicone Strips	7.12x1.92x0.73 in	181x49x19 mm
1-2720	Base and Lid with 2 Silicone Strips for 2 Diamond Knives	7.12x1.92x0.73 in	181x49x19 mm
1-3710	Base and Lid with 2 Silicone Strips for 3 Diamond Knives	7.10x2.86x0.73 in	180x73x19 mm
1-7100	Single-Level Base, Lid and Mat (Shallow)	5.65x7.25x1.2 in	143x184x30 mm
1-7110	Single-Level Base, Lid and Mat (Deep)	10.5x6.25x0.62 in	267x159x16 mm
1-7120	Double-Level Base, Lid and 2 Mat	10.5x6.25x1.3 in	267x139x35 mm

MicroPak Base, Lid & Silicone Bars

CODE	DESCRIPTION	DIMENSIONS (INTERNAL)	
0126	1 Diamond Knife	2x6x0.8 in	50x152x19 mm
0127	2 Diamond Knives	2x6x0.8 in	50x152x19 mm
0128	3 Diamond Knives	3x6x0.8 in	76x152x19 mm

Please consult the product Instructions for Use, inserts and labels for specific information regarding intended use, contra-indications, warnings and cautions.

MultiPak

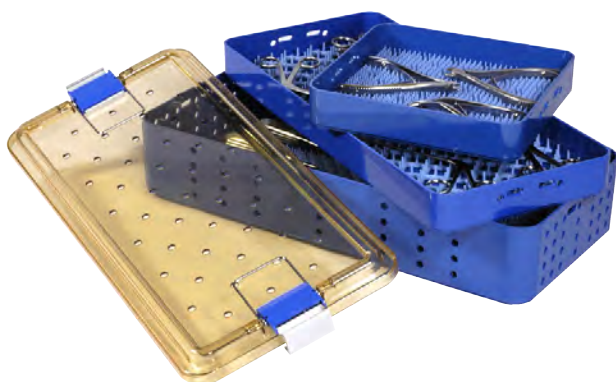

MultiPak

The MultiPak is a highly versatile tray system designed for organizing and protecting your delicate surgical instrumentation. The modular design, coupled with a wide array of components, permits the custom configuration of virtually any instrument set.

KEY BENEFITS:

- Flexibility made possible by a wide array of modular components
- Buy only the pieces you need



5000-50-000P

5000-01-475P

MultiPak Base Units & Lids

CODE	DESCRIPTION	DIMENSIONS (INTERNAL)	
5000-01-275P	Large Base Unit	9.2 x 20 x 2.6 in	234 x 508 x 66 mm
5000-01-375P	Large Base Unit	9.2 x 20 x 3.6 in	234 x 508 x 91 mm
5000-01-475P	Large Base Unit	9.2 x 20 x 4.6 in	234 x 508 x 117 mm
5000-50-000P	Clear Lid for 5000 Base	9.7 x 20.5 x 0.2 in	246 x 520 x 5.0 mm
5000-50-175P	Clear Elevated Lid	9.7 x 20 x 1.4 in	246 x 508 x 36 mm

Please consult the product Instructions for Use, inserts and labels for specific information regarding intended use, contra-indications, warnings and cautions.

Questions? Contact us at customerservice@symmetrysurgical.com or learn more at symmetrysurgical.com

MultiPak



5010-03-180P

MultiPak Insert Trays

CODE	DESCRIPTION	DIMENSIONS (INTERNAL)	
5010-03-180P	Full Insert Tray for 5000 Base	9.2 x 20 x 4.6 in	234 x 508 x 117 mm
5012-03-180P	Long Insert Tray for 5000 Base	9.7 x 20.5 x 0.2 in	246 x 520 x 5.0 mm
5022-03-180P	Insert Tray for 5000 Base	8.7 x 9.5 x 1.7 in	221 x 241 x 43 mm
5023-03-180P	Insert Tray for 5000 Base	9.2 x 20 x 3.6 in	234 x 508 x 91 mm
5024-03-180P	Insert Tray with Shelf Hangers (for 5123-03-375P Tray)	8.5 x 12.5 x 1.78 in	216 x 318 x 45 mm
5122-03-375P	Deep Insert Tray for 5000 Base*	9.7 x 20 x 1.4 in	246 x 508 x 36 mm
5123-03-375P	Deep Insert Tray for 5000 Base*	8.7 x 12.7 x 3.3 in	221 x 353 x 84 mm

*Compatible with MultiPak elevated lids only.



5010-50-000P

MultiPak Clear Lids

CODE	DESCRIPTION	DIMENSIONS (INTERNAL)	
5010-50-000P	Clear Lid for 5010 Insert Tray	9.1 x 19.9 x 0.2 in	231 x 506 x 5.0 mm
5012-50-000P	Clear Lid for 5012 Insert Tray	4.3 x 19.9 x 0.2 in	109 x 506 x 5.0 mm
5022-50-000P	Clear Lid for 5022 Insert Tray	9 x 9.8 x 0.2 in	229 x 249 x 5.0 mm
5023-50-000P	Clear Lid for 5023 Insert Tray	9 x 13 x 0.2 in	229 x 330 x 5.0 mm

Please consult the product Instructions for Use, inserts and labels for specific information regarding intended use, contra-indications, warnings and cautions.

MultiPak



5006-50-000P

5006-03-150P

5006-01-390P

MultiPak Jr. Units

CODE	DESCRIPTION	DIMENSIONS (INTERNAL)	
5006-01-390P	Base Unit	5.5 x 12.8 x 3.9 in	140 x 325 x 98 mm
5006-03-150P	Insert Tray for 5006 Base	5.1 x 11.2 x 1 in	130 x 285 x 25 mm
5006-50-000P	Transparent Lid for 5006 Base	5.8 x 12.9 x 0.2 in	147 x 328 x 5.0 mm



5010-50-175P

MultiPak Elevated Lids

CODE	DESCRIPTION	DIMENSIONS (INTERNAL)	
5010-50-175P	Elevated Lid for 5010 Insert Tray	19.3 x 8.5 x 1.4 in	490 x 216 x 36 mm
5022-50-175P	Elevated Lid for 5022 or 5122 Insert Trays	8.4 x 9.1 x 1.4 in	213 x 231 x 36 mm
5023-50-175P	Elevated Lid for 5023 or 5123 Insert Tray	8.4 x 12.4 x 1.4 in	213 x 315 x 36 mm



5023-50-E

MultiPak Tray with Plastic Snap Latch

CODE	DESCRIPTION	DIMENSIONS (INTERNAL)	
5023-03-E	Insert Tray for 5000 Base	8.7 x 12.8 x 1.3 in	221 x 325 x 33 mm
5023-50-E	Clear Lid for 5023-03-E Insert Tray	8.8 x 13.1 x 0.2 in	224 x 333 x 5.0 mm

Please consult the product Instructions for Use, inserts and labels for specific information regarding intended use, contra-indications, warnings and cautions.

Questions? Contact us at customerservice@symmetrysurgical.com or learn more at symmetrysurgical.com

MultiPak

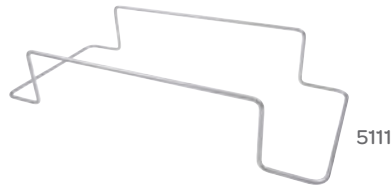

MultiPak Wire Racks

CODE	DESCRIPTION	DIMENSIONS	
5110	Wire Rack Instrument Holder for 5000 Base	8.7x19.7x3.3 in	222x500x83 mm
5111	Wire Rack Instrument Holder for 5000 Base (Requires 5000-50-175P)	8.7x19.7x3.8 in	222x500x95 mm
5108	Wire Rack for 5022 and 5122 Insert Tray	7.9x8.9x3 in	200x227x77 mm
5109	Wire Rack for 5023 and 5123 Insert Tray	7.9x12.9x3.2 in	200x312x82 mm

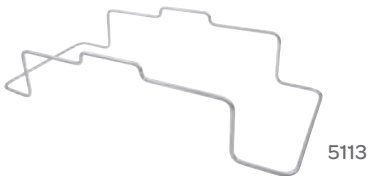

MultiPak Instrument Racks with Handle

CODE	DESCRIPTION	DIMENSIONS	
5112	Wire Rack with Handle, Instrument Holder for 5000 Base (Requires 5000-50-175P)	8.7x19.7x3.9 in	222x500x100 mm
5113	Wire Rack with Handle and Instrument Holder for 5000 Base (Requires 5000-50-175P)	8.7x19.7x4.3 in	222x500x109 mm
7113	Wire Rack with Handle for 7024	8.7x24.4x4.4 in	222x618x112 mm
7513	Wire Rack with Handle for 7026	9.34x24.5x5.5 in	237x622x140 mm



MultiPak Hybrid Trays, Aluminum Base with Clear Polymer Lid

CODE	DESCRIPTION	DIMENSIONS (INTERNAL)	
7024	Long Metal Base, Elevated Transparent Lid	9.1x24.4x6 in	231x619x152 mm
7024-01	Long Metal Base for 7024	9.4x24.7x4.6 in	239x627x117 mm
7024-02	Elevated Transparent Lid for 7024	9.1x24.4x1.4 in	231x619x36 mm
7024-04	Fine Pin Mat for 7024 Base	9.4x23 in	239x584 mm
7026	Long Metal Base, Elevated Transparent Lid	9.4x25.5x6.1 in	239x648x155 mm
7026-01	Long Metal Base for 7026	9.2x25.5x5.9 in	234x648x150 mm
7026-02	Elevated Transparent Lid for 7026	9.2x25.5x1.3 in	234x648x33 mm

Please consult the product Instructions for Use, inserts and labels for specific information regarding intended use, contra-indications, warnings and cautions.

MultiPak

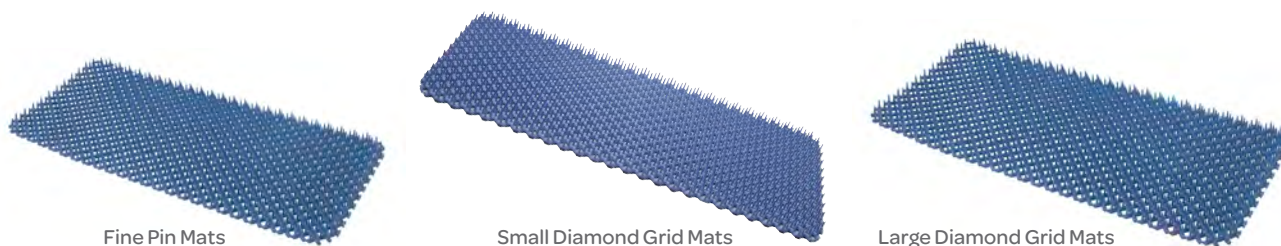

MultiPak Silicone Fine Pin Mats

CODE	DESCRIPTION	DIMENSIONS	
5000-04	Fine Pin Mat for 5000 Base	8.9x19.7 in	226x500 mm
5110-04	Fine Pin Mat for 5000 Base (For use with 5110 Rack)	8.9x18 in	226x457 mm
5006-04	Fine Pin Mat for 5006 Base	5.4x12.5 in	137x318 mm
5010-04	Fine Pin Mat for 5010 Full Insert Tray	8.4x19.2 in	213x488 mm
5012-04	Fine Pin Mat for 5012 Tray Insert	3.7x19.2 in	94 x 489 mm
5022-04	Fine Pin Mat for 5022 Tray Insert	8.4x9.1 in	213x231 mm
5023-04	Fine Pin Mat for 5023 Tray Insert	8.4x12.5 in	213x318 mm
5023-04-E	Fine Pin Mat for 5023-03-E Tray Insert	8.4x12.5 in	213x318 mm

MultiPak Silicone Small Diamond Grid Mats (Shown Above)

CODE	DESCRIPTION	DIMENSIONS	
5000-04SD	Small Diamond Grid Mat for 5000 Base	8.9x19.7 in	226 X 500 mm
5110-04SD	Small Diamond Grid Mat for 5000 Base (For use with 5110 Rack)	8.9x18 in	226 x 457 mm
5010-04SD	Small Diamond Grid Mat for 5010 Full Tray Insert	8.4x19.2 in	213 x 488 mm
5012-04SD	Small Diamond Grid Mat for 5012 Full Tray Insert	3.7x19.2 in	94 x 489 mm
5022-04SD	Small Diamond Grid Mat for 5022 Tray Insert	8.4x9.1 in	213 x 231 mm
5023-04SD	Small Diamond Grid Mat for 5023 Tray Insert	8.4x12.5 in	213 x 318 mm
7026-04SD	Small Diamond Grid Mat for 5026 Base	9.4x25 in	239 x 635 mm

MultiPak Silicone Large Diamond Grid Mats (Shown Above)

CODE	DESCRIPTION	DIMENSIONS	
5000-04D	Large Diamond Grid Mat for 5000 Base	8.9x19.7 in	226x500 mm
5110-04D	Large Diamond Grid Mat for 5000 Base (for use With 5110 Rack)	8.9x19 in	226 x 457 mm
5006-04D	Large Diamond Grid Mat for 5006 Base	5.4x12.5 in	137x318 mm
5010-04D	Large Diamond Grid Mat for 5010 Full Tray Insert	8.4x19.2 in	213x488 mm
5012-04D	Large Diamond Grid Mat for 5012 Full Tray Insert	3.7x19.2 in	94 x 489 mm
5022-04D	Large Diamond Grid Mat for 5022 Tray Insert	8.4x9.1 in	213 x 231 mm
5023-04D	Large Diamond Grid Mat for 5023 Tray Insert	8.4x12.5 in	213x318 mm
5023-04-E-D	Large Diamond Grid Mat for 5023-E Tray Insert and 5109 Wire Rack	8.4x12.5 in	213x318 mm
5108-04D	Large Diamond Grid Mat for 5022 Tray Insert and 5108 Wire Rack	8.3x9 in	211 x 229 mm
5109-04D	Large Diamond Grid Mat for 5023 Tray Insert and 5109 Wire Rack	8.3x12.4 in	211 x 315 mm

Please consult the product Instructions for Use, inserts and labels for specific information regarding intended use, contra-indications, warnings and cautions.

Questions? Contact us at customerservice@symmetrysurgical.com or learn more at symmetrysurgical.com

MultiPak

MultiPak Silicone Accessories

ITEM	CODE	DESCRIPTION	SIZE	
	5300	6-Slot Instrument Bar, 3.0 mm Diameter	7 in	17.8 cm
	5301	6-Slot Instrument Bar, 6.0 mm Diameter	7 in	17.8 cm
	5302	6-Slot Instrument Bar, 6.35 mm Diameter	7 in	17.8 cm
	5312	4-Slot Instrument Bar	2.9 in	7.4 cm
	5332	Double 3-Slot Instrument Bar, 5.0 and 10 mm Diameter	2.9 in	7.4 cm
	5333	5-Slot Instrument Bar, 5.0 mm Diameter	2.9 in	7.4 cm
	5335	5-Slot Instrument Bar, 3.0 mm Diameter	2.9 in	7.4 cm
	5339	Instrument Bar, Camera Holder	2.9 in	7.4 cm
	5340	Double-Ended Scope Holder, Open 12 mm Diameter, Closed 8.0 mm Diameter	2.9 in	7.4 cm
	5341	Double-Ended Scope Holder, Open 12 mm Diameter	2.9 in	7.4 cm
	5343	2-Slot Scope Holder, Open 15 mm Diameter, Closed 12 mm Diameter	2.9 in	7.4 cm
	5352	Scope Holder, Closed End, 12 mm Diameter	1.5 in	3.8 cm
	5353	Scope Holder, Open End, 12 mm Diameter	1.5 in	3.8 cm
	5372	Double 9-Slot Silicone Instrument Bar, 5.0 and 10 mm Diameter	7 in	17.8 cm
	5373	12-Slot Instrument Bar, 5.0 mm Diameter	7 in	17.8 cm
	5375	12-Slot Instrument Bar, 3.0 mm Diameter	7 in	17.8 cm















*Silicone accessories include plastic holding bar and screws; excluding 5310

Please consult the product Instructions for Use, inserts and labels for specific information regarding intended use, contra-indications, warnings and cautions.

Questions? Contact us at customerservice@symmetrysurgical.com or learn more at symmetrysurgical.com

MultiPak

MultiPak Accessories

ITEM	CODE	DESCRIPTION	SIZE	
	4S5231	Stainless Steel L Shelf Bracket (Compatible with MultiPak III Only)		
	5231	L Shelf Bracket		
	5233	T Shelf Bracket		
	5241	Post, Plastic Holding	1.41 in	3.58 cm
	5250	Post, Short, Movable	1.24 in	3.14 cm
	5251	Post, Long, Movable	2 in	5.08 cm
	5310	Bar, Blank, (Priced Per Foot)	12 in	30.5 cm
	5311	Bar, Blank	2.9 in	7.4 cm
	5320	3-Slot Instrument Bar, 5.0 mm Diameter	2.9 in	7.4 cm
	5330	3-Slot Instrument Bar, 3.0-8.0 mm Diameter	2.9 in	7.4 cm
	5331	3-Slot Instrument Bar, 8.0-15 mm Diameter	2.9 in	7.4 cm
	5334	3-Slot Instrument Bar, 10 mm Diameter	2.9 in	7.4 cm
	5370	10-Slot Instrument Bar, 3.0-8.0 mm Diameter	7 in	17.8 cm
	5371	8-Slot Instrument Bar, 8.0-15 mm Diameter	7 in	17.8 cm
	5374	8-Slot Instrument Bar, 10 mm Diameter	7 in	17.8 cm















*Silicone accessories include plastic holding bar and screws; excluding 5310

Please consult the product Instructions for Use, inserts and labels for specific information regarding intended use, contra-indications, warnings and cautions.

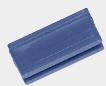
Questions? Contact us at customerservice@symmetrysurgical.com or learn more at symmetrysurgical.com

MultiPak

MultiPak Accessories

ITEM	CODE	DESCRIPTION	SIZE	
	5120	Celcon Nuts and Bolts, Package of 10		
	5121	Metal Screw, Black, for 5231 and 5233 Package of 50	0.25 in	6.4 mm
	5122	Metal Screw, Black, for 5241 Post Package of 50	0.375 in	9.5 mm
	5130	Metal Carrying Handle Kit, for 5000-01, 5010-03 and 5022-03		
	5200	Endoscopic Silicone Bar Holder, for Wire Rack 5100-5113, 7113	7 in	177 mm
	5200N	Endoscopic Silicone Bar Holder, for Wire Rack 5108 or 5109	6.5 in	165 mm
	7200	Endoscopic Silicone Bar Holder, for Wire Rack Only 7513	7 in	177 mm
	5210	Holder, Slotted Plastic, for Silicone Bars	2.9 in	73 mm
	5211	Holder, Slotted Plastic, for Silicone Bar	7 in	177 mm
	5215	Holder, Slotted, for 5235 and 5236 Only	1.5 in	38.1 mm
	5216	Nameplate (Blank)	4.7 x 2.5 in	199 x 64 mm
	5235	Divider, Short, Package of 2, for use with 5000 Base Only, Requires 5236	9.1 x 2.8 in	231 x 71 mm
	5236	Divider, Long, Package of 2, for use with 5000 Base Only, Requires 5236	19.9 x 2.8 in	505 x 71 m
	5237	Divider, Short (For use with 5010 Insert Trays)		
	5238	Divider, Long (For use with 5010 Insert Trays)		

*Silicone accessories include plastic holding bar and screws; excluding 5310

Please consult the product Instructions for Use, inserts and labels for specific information regarding intended use, contra-indications, warnings and cautions.

MultiPak III



Aluminum Base Units & Lids



Aluminum Inserts

MultiPak III Aluminum Base Units & Lids

CODE	DESCRIPTION	DIMENSIONS (INTERNAL)	
4A231404	Aluminum Base and Lid	23 x 14 x 4 in	584 x 356 x 102 mm
4A0W101030	Aluminum Base	9.45 x 10.22 x 3 in	240 x 260 x 76 mm
4A0W101045	Aluminum Base	9.45 x 10.22 x 4.5 in	240 x 260 x 114 mm
4A0W101060	Aluminum Base	9.45 x 10.22 x 6 in	240 x 260 x 152 mm
4A0W102030	Aluminum Base	9.45 x 20.05 x 3 in	240 x 509 x 76 mm
4A0W102045	Aluminum Base	9.45 x 20.05 x 4.5 in	240 x 509 x 114 mm
4A0W102060	Aluminum Base	9.45 x 20.05 x 6 in	240 x 509 x 152 mm
4A0W102630	Aluminum Base	9.45 x 25.52 x 3 in	240 x 648 x 76 cm
4A0W102645	Aluminum Base	9.45 x 25.52 x 4.5 in	240 x 648 x 114 mm
4A0W102660	Aluminum Base	9.45 x 25.52 x 6 in	240 x 648 x 152 mm
4A9W101003	Lid for Aluminum Base	9.695 x 10.65 x 0.386 in	246 x 270 x 10 mm
4A9W102003	Lid for Aluminum Base	9.695 x 20.48 x 0.386 in	246 x 520 x 10 mm
4A9W102603	Lid for Aluminum Base	9.695 x 25.95 x 0.386 in	246 x 659 x 10 mm

MultiPak III Aluminum Inserts & Lids (Shown Above)

CODE	DESCRIPTION	DIMENSIONS (INTERNAL)	
4A1W091017	Sided Insert	8.84 x 9.4 x 1.72 in	224 x 239 x 44 mm
4A1W091317	Sided Insert	8.84 x 12.65 x 1.72 in	224 x 321 x 44 mm
4A1W092017	Sided Insert	8.84 x 19.45 x 1.72 in	224 x 494 x 44 mm
4A8W091003	Lid for Sided Insert	9.08 x 9.83 x 0.354 in	230 x 249 x 9.0 mm
4A8W091303	Lid for Sided Insert	9.08 x 13.08 x 0.354 in	230 x 332 x 9.0 mm
4A8W092003	Lid for Sided Insert	9.08 x 19.88 x 0.354 in	230 x 505 x 9.0 mm

MultiPak III Aluminum Sideless Inserts

CODE	DESCRIPTION	DIMENSIONS (INTERNAL)	
4A2W091011	Sideless Insert	9 x 9.65 x 1.3 in	228 x 245 x 26 mm
4A2W091018	Sideless Insert	9 x 9.65 x 1.715 in	228 x 245 x 44 mm
4A2W091026	Sideless Insert	9 x 9.65 x 2.465 in	228 x 245 x 63 mm
4A2W092011	Sideless Insert	9 x 19.7 x 1.3 in	228 x 500 x 26 mm
4A2W092018	Sideless Insert	9 x 19.7 x 1.715 in	228 x 500 x 44 mm
4A2W092026	Sideless Insert	9 x 19.7 x 2.465 in	228 x 500 x 63 mm
4A2W092511	Sideless Insert	9 x 25.03 x 1.3 in	228 x 635 x 26 mm
4A2W092518	Sideless Insert	9 x 25.03 x 1.715 in	228 x 635 x 44 mm
4A2W092526	Sideless Insert	9 x 25.03 x 2.465 in	228 x 635 x 63 mm

Please consult the product Instructions for Use, inserts and labels for specific information regarding intended use, contra-indications, warnings and cautions.

Questions? Contact us at customerservice@symmetrysurgical.com or learn more at symmetrysurgical.com

MultiPak III



Stainless Steel
Base Units & Lids



Stainless Steel Inserts

MultiPak III Stainless Steel Base Units & Lids

CODE	DESCRIPTION	DIMENSIONS (INTERNAL)	
4SOW101030	Stainless Steel Base	9.45 x 10.22 x 3 in	240 x 260 x 76 mm
4SOW101045	Stainless Steel Base	9.45 x 10.22 x 4.5 in	240 x 260 x 114 mm
4SOW101060	Stainless Steel Base	9.45 x 10.22 x 6 in	240 x 260 x 152 mm
4SOW102030	Stainless Steel Base	9.45 x 20.05 x 3 in	240 x 509 x 76 mm
4SOW102045	Stainless Steel Base	9.45 x 20.05 x 4.5 in	240 x 509 x 114 mm
4SOW102060	Stainless Steel Base	9.45 x 20.05 x 6 in	240 x 509 x 152 mm
4SOW102630	Stainless Steel Base	9.45 x 25.52 x 3 in	240 x 648 x 76 mm
4SOW102645	Stainless Steel Base	9.45 x 25.52 x 4.5 in	240 x 648 x 114 mm
4SOW102660	Stainless Steel Base	9.45 x 25.52 x 6 in	240 x 648 x 152 mm
4S9W101003	Stainless Steel Lid	9.695 x 10.65 x 0.386 in	246 x 270 x 10 mm
4S9W102003	Stainless Steel Lid	9.695 x 20.48 x 0.386 in	246 x 520 x 10 mm
4S9W102603	Stainless Steel Lid	9.695 x 25.95 x 0.386 in	246 x 659 x 10 mm

MultiPak III Stainless Steel Inserts & Lids (Shown Above)

CODE	DESCRIPTION	DIMENSIONS (INTERNAL)	
4S1W091017	Sided Insert	8.84 x 9.4 x 1.72 in	224 x 239 x 44 mm
4S1W091317	Sided Insert	8.84 x 12.65 x 1.72 in	224 x 321 x 44 mm
4S1W092017	Sided Insert	8.84 x 19.45 x 1.72 in	224 x 494 x 44 mm
4S8W091003	Lid for Sided Insert	9.08 x 9.83 x 0.354 in	230 x 249 x 9.0 mm
4S8W091303	Lid for Sided Insert	9.08 x 13.08 x 0.354 in	230 x 332 x 9.0 mm
4S8W092003	Lid for Sided Insert	9.08 x 19.88 x 0.354 in	230 x 505 x 9.0 mm

MultiPak III Stainless Steel Sideless Inserts

CODE	DESCRIPTION	DIMENSIONS (INTERNAL)	
4S2W091011	Sideless Insert	9 x 9.65 x 1.3 in	228 x 245 x 26 mm
4S2W091018	Sideless Insert	9 x 9.65 x 1.715 in	228 x 245 x 44 mm
4S2W091026	Sideless Insert	9 x 9.65 x 2.465 in	228 x 245 x 63 mm
4S2W092011	Sideless Insert	9 x 19.7 x 1.3 in	228 x 500 x 26 mm
4S2W092018	Sideless Insert	9 x 19.7 x 1.715 in	228 x 500 x 44 mm
4S2W092026	Sideless Insert	9 x 19.7 x 2.465 in	228 x 500 x 63 mm
4S2W092511	Sideless Insert	9 x 25.03 x 1.3 in	228 x 635 x 26 mm
4S2W092518	Sideless Insert	9 x 25.03 x 1.715 in	228 x 635 x 44 mm
4S2W092526	Sideless Insert	9 x 25.03 x 2.465 in	228 x 635 x 63 mm

Please consult the product Instructions for Use, inserts and labels for specific information regarding intended use, contra-indications, warnings and cautions.

Quick Kit

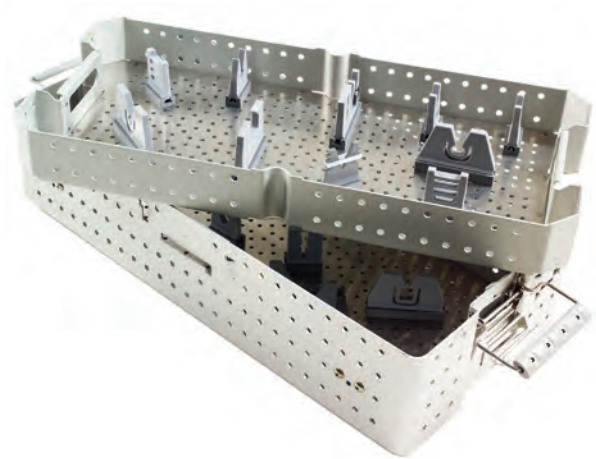

Quick Kit

The Quick Kit provides customized case solutions in a reduced timeframe. Quick Kits are ideally suited for use with large instruments: trauma, spinal or orthopedic.

Over 25 silicone and Radel® R brackets accommodate a wide variety of instruments.

KEY BENEFITS:

- Each bracket packaged with track and screws for easy assembly
- Unique hole pattern allows brackets to be placed at different angles in 45° increments
- Replacement tracks also available

Metal Level Assemblies

CODE	DESCRIPTION	LEVELS	DIMENSIONS (INTERNAL)	
28200	2 in Deep Base and Lid	Single	19.75 x 9.4 x 2 in	502 x 239 x 51 mm
28100	4 in Deep Base, Lid and Insert	Double	19.75 x 9.4 x 4 in	502 x 239 x 102 mm

Polymer Brackets

CODE	DESCRIPTION	DIMENSIONS	
28122	With 2 Adjustable Bands, Ideal for Delicate Instruments	1.5 x 2 in	38 x 51 mm
28123	Sloped Locking Brackets (Pair), Ideal for Large And Heavy Instruments	1.5 x 2 in	38 x 51 mm
28126	Solid Bracket, Ideal as a Barrier or Divider	1.5 x 2 in	38 x 51 mm
2-8127	Solid Bracket, Ideal as a Barrier or Divider	3 x 2 in	76 x 51 mm
28128	Single Track	1.5 in	38 mm
28129	Single Track	3 in	76 mm
28130	Double Track	1.5 in	38 mm
28131	Double Track	3 in	76 mm

Please consult the product Instructions for Use, inserts and labels for specific information regarding intended use, contra-indications, warnings and cautions.

Questions? Contact us at customerservice@symmetrysurgical.com or learn more at symmetrysurgical.com

Quick Kit

Silicone Brackets

	CODE	DESCRIPTION	DIMENSIONS	
	28101	Retainer Bracket, Expandable, Ideal for Oval Geometry 0.5x0.18 in	3 x 2 in	76 x 51 mm
	2-8102	Retainer Bracket, Expandable, Ideal for Oval Geometry 0.5 x 0.38 in	3 x 2 in	76 x 51 mm
	2-8103	Retainer Bracket, Expandable, Ideal for Round Geometry 0.13 in–0.38 Diameter	1.5 x 2 in	38 x 51 mm
	28104	Retainer Bracket, Expandable, Ideal for Round Geometry 0.38– $\frac{3}{4}$ in Diameter	3 x 2 in	76 x 51 mm
	2-8105	Retainer Bracket, Expandable, Ideal for Round Geometry 0.75–1.12 in Diameter	3 x 2 in	76 x 51 mm
	2-8116	Retainer Bracket, Expandable, Ideal for Square Geometry 0.5 in	3 x 2 in	76 x 51 mm
	2-8118	Retainer Bracket, Expandable, Ideal for Triangular Geometry 0.38 in	3 x 2 in	76 x 51 mm
	2-8119	Retainer Bracket with Latch, Ideal for Delicate Instruments	1.5 x 2 in	38 x 51 mm
	2-8109	Retainer Bracket, Ideal for Rectangular Geometry 0.5 x 0.25 in	1.5 x 2 in	38 x 51 mm
	2-8110	Retainer Bracket, Ideal for Rectangular Geometry 1.25 x 0.38 in	3 x 2 in	76 x 51 mm
	2-8115	Retainer Bracket, Ideal for Rectangular Square 0.25 in	1.5 x 2 in	38 x 51 mm
	2-8117	Retainer Bracket, Ideal for Triangular Geometry 0.25 in	1.5 x 2 in	38 x 51 mm
	28124	Solid Bracket 1 $\frac{1}{2}$ in, Ideal as a Barrier or Divider	1.5 x 2 in	38 x 51 mm
	28125	Solid Bracket 3 in, Ideal as a Barrier or Divider	3 x 2 in	76 x 51 mm
	28106	Support Bracket, Expandable, Ideal for Round Geometry, Approx 0.38 in	3 x 2 in	76 x 51 mm
	28134	Support Bracket, Expandable, Ideal for Round Geometry, Approx 0.12 in		
	2-8114	Support Bracket, Three Positions, Ideal for Rectangular Geometry 0.18 x 1.12 in	3 x 2 in	76 x 51 mm
	2-8113	Support Bracket, Ideal for Rectangular Geometry 0.12 x 1 in	1.5 x 2 in	38 x 51 mm
	2-8111	Silicone Support Bracket, Ideal for Rectangular Geometry 0.18 x 1.25 in	1.5 x 2 in	38 x 51 mm
	2-8112	Silicone Support Bracket, Ideal for Rectangular Geometry 0.25 x 1.25 in	3 x 2 in	76 x 51 mm
	28107	Silicone Support Bracket, Ideal for Round Geometry, Approx 0.12 in	1.5 x 2 in	38 x 51 mm
	28108	Silicone Support Bracket, Ideal for Round Geometry, Approx 0.25 in	3 x 2 in	76 x 51 mm
	2-8121	Silicone Trim-to-Fit Bracket, Length and Height Adjustment	3 x 2 in	76 x 51 mm
	28120	Silicone Trim-to-Fit Bracket, Multi-Level Adjustment	1.5 x 2 in	38 x 51 mm

Please consult the product Instructions for Use, inserts and labels for specific information regarding intended use, contra-indications, warnings and cautions.

ScopePak

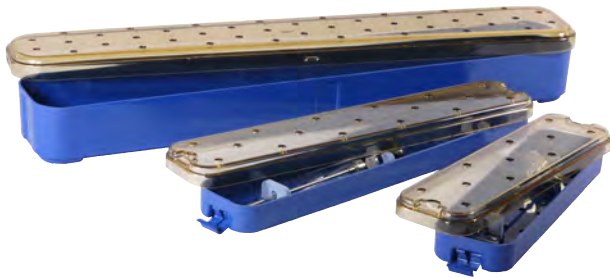

ScopePak Benefits

The ScopePak offers engineered protection for the handling and storage of costly endoscopes. Available in a variety of sizes to fit a broad range of endoscopes, each tray features silicone holding bars to secure the endoscope in place, and a transparent lid for easy identification.

KEY BENEFITS:

- Endoscopes are fixed in place with unique silicone holding bars
- ScopePak is compatible with steam and ETO sterilization
- Transparent lid allows for easy instrument identification

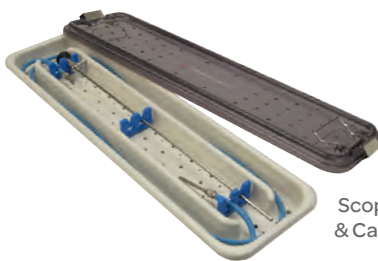

ScopePak Scope
& Cable Case

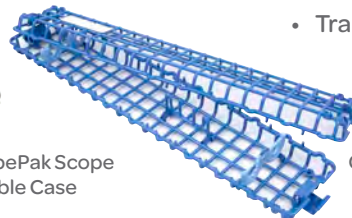

OnePak Case

ScopePak Cases

CODE	DESCRIPTION	DIMENSIONS (INTERNAL)	
3-1210	Universal Scope and Light Cable Case	18.3 x 8.3 x 2 in	465 x 212 x 51 mm
3-5120	Arthroscopy Scope and Cable Case	16.9 x 6.1 x 1.5 in	430 x 155 x 38 mm
3-5130	Extra-Long Scope and Cable Case	25 x 6.1 x 1.5 in	635 x 155 x 38 mm
3-7110	Combination Arthroscope Case	10.5 x 6.2 x 1.5 in	267 x 159 x 34 mm
9417-1	OnePak, 17 in, Configured to Accommodate 1 Scope	3.2 x 1.7 x 1.5 in	82.5 x 43 x 38 mm
9417	OnePak, 17 in, for 2 Scopes	3.2 x 1.7 x 1.5 in	82.5 x 43 x 38 mm

ScopePak Base & Lid with Scope Holder Sets

CODE	DESCRIPTION	INCLUDES	DIMENSIONS (INTERNAL)	
9312	Small Base and Lid	2/Each 5350 1/Each 5351	3 x 11.1 x 1.3 in	76 x 282 x 33 mm
9317	Medium Base and Lid	4/Each 5353 2/Each 5352	3 x 16 x 1.3 in	76 x 406 x 33 mm
9321	Large Base and Lid	2/Each 5350 1/Each 5351	3 x 20 x 1.3 in	76 x 508 x 33 mm
9326	Extra-Large Base and Lid	1/Each 5350 1/Each 5351	4 x 26 x 2.8 in	102 x 660 x 71 mm
9331	Long Base and Lid	4/Each 5353 2/Each 5352	4.7 x 30.3 x 2.8 in	119 x 769 x 71 mm

ScopePak Base & Lid Only

CODE	DESCRIPTION	DIMENSIONS (INTERNAL)	
9312-00	Small Base and Lid	3 x 11.1 x 1.3 in	76 x 282 x 33 mm
9317-00	Medium Base and Lid	3 x 16 x 1.3 in	76 x 406 x 33 mm
9321-00	Large Base and Lid	3 x 20 x 1.3 in	76 x 508 x 33 mm
9326-00	Extra-Large Base and Lid	4 x 26 x 2.8 in	102 x 660 x 71 mm
9331-00	Long Base and Lid	4.7 x 30.3 x 2.8 in	119 x 769 x 71 mm

Please consult the product Instructions for Use, inserts and labels for specific information regarding intended use, contra-indications, warnings and cautions.

Questions? Contact us at customerservice@symmetrysurgical.com or learn more at symmetrysurgical.com

ScopePak

ScopePak Silicone Accessories

ITEM	CODE	DESCRIPTION	SIZE
	5210	Plastic Holder for Silicone Bars	2.9 inches (74 mm)
	5212	Plastic Holder for Silicone Bars	1.5 inches (38 mm)
	5340	Double-Ended Silicone Scope Holder	Open 12 mm Diameter, Closed 8.0 mm Diameter 2.9 inches (74 mm)
	5341	Open Double-Ended Silicone Scope Holder	12 mm Diameter, 2.9 inches (74 mm)
	5343	2-Slot Silicone Scope Holder	Open 15 mm Diameter, Closed 12 mm Diameter 2.9 inches (74 mm)
	5350	Open-Ended Silicone Scope Holder	15 mm Diameter, 1.5 inches (38 mm)
	5351	Closed-Ended Silicone Scope Holder	8.0 mm Diameter, 1.5 inches (38 mm)
	5352	Closed-Ended Silicone Scope Holder	12 mm Diameter, 1.5 inches (38 mm)
	5353	Open-Ended Silicone Scope Holder	12 mm Diameter, 1.5 inches (38 mm)
	5354	Closed-Ended Silicone Scope Holder	6.0 mm Diameter, 1.5 inches (38 mm)
	5355	Closed-Ended Silicone Scope Holder	4.0 mm Diameter, 1.5 inches (38 mm)

*Silicone accessories include plastic holding bar and screws; excluding 5310

StackPak

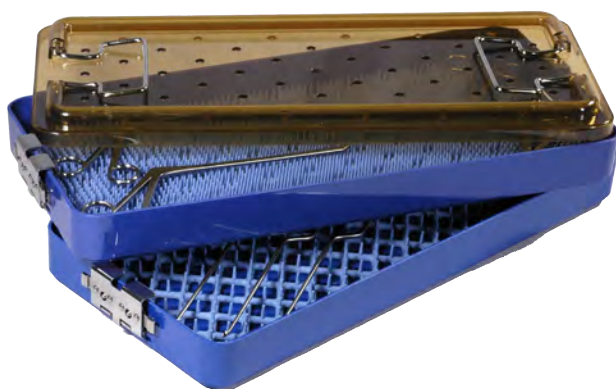

StackPak

StackPak is a revolutionary new way to handle, transport, organize and sterilize delicate surgical instrumentation. The unique latch design creates a simple way to combine complex instrument sets into one neat package.

KEY BENEFITS:

- Fully modular system is compatible with all existing MultiPak accessories
- Add additional trays if the set expands
- Only ONE lid needed to cover the entire system
- New latch design allows you to stack trays while keeping them secure

StackPak Trays

CODE	DESCRIPTION	DIMENSIONS (INTERNAL)	
5722-03-180P	Half Length Tray	9.5 x 8.7 x 1.7 in	241 x 221 x 43 mm
5722-03-375P	Half Deep Tray	9.5 x 8.7 x 3.6 in	241 x 221 x 91 mm
5723-03-180P	Two-Thirds Length Tray	12.7 x 8.7 x 1.7 in	323 x 221 x 43 mm
5723-03-375P	Two-Thirds Deep Tray	12.7 x 8.7 x 3.6 in	323 x 221 x 91 mm
5710-03-180P	Full Length Tray	19.5 x 8.7 x 1.7 in	495 x 221 x 43 mm
5710-03-375P	Deep Full Tray	19.5 x 8.7 x 3.6 in	495 x 221 x 91 mm

StackPak Lids

CODE	DESCRIPTION	DIMENSIONS (INTERNAL)	
5722-50-000P	Half Length Lid	9.8 x 9 x 0.2 in	249 x 228 x 5.0 mm
5723-50-000P	Two-Thirds Length Lid	13 x 9 x 0.2 in	330 x 228 x 5.0 mm
5710-50-000P	Full Length Lid	19.9 x 9 x 0.2 in	505 x 228 x 5.0 mm

Please consult the product Instructions for Use, inserts and labels for specific information regarding intended use, contra-indications, warnings and cautions.

Questions? Contact us at customerservice@symmetrysurgical.com or learn more at symmetrysurgical.com

TransPak



8600



TransPak

The TransPak was engineered to protect personnel from the hazards of contaminated instruments after surgical use. This strong, lightweight plastic soaking system is designed for minimized spillage and splashing, helping to protect hands and eyes from possible infection during transport to cleaning facilities. The TransPak meets AORN and ANSI/AAMI standards for proper transport of contaminated surgical instruments.

The removable insert tray permits the safe transfer of contaminated instruments with no hand contact; the TransPak itself can be transferred directly to a washer/decontaminator.

KEY BENEFITS:

- Minimized spillage and splashing protects personnel
- Engineered to withstand the rigors of repeat use
- Removable insert tray designed to accept MultiPak and many other instrument trays

TransPak Base, Lid & Insert

CODE	DESCRIPTION	DIMENSIONS (INTERNAL)	
8600	Base, Lid and Insert	12.6 x 23.5 x 5.8 in	32 x 59.6 x 14.7 cm
8600-00	Base and Lid	12.6 x 23.5 x 5.8 in	32 x 59.6 x 14.7 cm
8600-01	Base Only	12.6 x 23.5 x 6.14 in	32 x 59.6 x 15.6 cm
8600-02	Lid Only	14.5 x 25.4 x 0.5 in	36.8 x 64.5 x 1.3 cm
8600-03	Insert Only	9.7 x 20.7 x 5.49 in	24.6 x 52.5 x 13.9 cm

Please consult the product Instructions for Use, inserts and labels for specific information regarding intended use, contra-indications, warnings and cautions.

Specialty Trays



Bookwalter® Cases

CODE	DESCRIPTION
50-4508	Bookwalter® Blades and Accessory Case
50-4507	Bookwalter® Table Fixation and Ring Case
50-4604	Bookwalter® I.M.A. Case
50-4647	Bookwalter® Spinal Retractor Case



Castaneda Instrument Case

CODE	DIMENSIONS	
21-8010	11 x 7 x 2 in	279 x 178 x 51 mm



Crockard™ Transoral Instrument Case

CODE	DIMENSIONS	
50-1664	18 x 10.5 x 7.25 in	457 x 266 x 184 mm



Dietrich Instrument Case

CODE	DIMENSIONS	
21-8000	18 x 10.5 x 7.25 in	457 x 266 x 184 mm

Please consult the product Instructions for Use, inserts and labels for specific information regarding intended use, contra-indications, warnings and cautions.

Questions? Contact us at customerservice@symmetrysurgical.com or learn more at symmetrysurgical.com

Specialty Trays



Gouge & Osteotome Case

Holds 7 Smith-Petersen Gouges or Osteotomes

CODE	DIMENSIONS	
21-2500	9 x 6.875 x 2.25 in	229 x 175 x 57 mm



Greenberg® Universal Retractor Case

Note: Instruments not included

CODE	DIMENSIONS	
50-1514	10 x 2.375 x 17 in	254 x 60 x 432 mm



Hardy™ Instrument Case*

For 16 Bayonet Dissectors

CODE	DIMENSIONS	
80-1355	11 x 7 x 2.25 in	279 x 178 x 57 mm

*Does Not Hold Bipolar Forceps



Hudson Cranial Drill Instrument Case

CODE	DESCRIPTION
68-1002	Case Holds Hand Drill, Extension and 4 Burrs



Instrument Case

For Anterior Cervical Fusion Instruments

CODE	DIMENSIONS	
21-1001	9 x 2.625 x 9 in	229 x 67 x 229 mm

Please consult the product Instructions for Use, inserts and labels for specific information regarding intended use, contra-indications, warnings and cautions.

Questions? Contact us at customerservice@symmetrysurgical.com or learn more at symmetrysurgical.com

Specialty Trays



Karlin™ Magnum Chisel Rack

CODE	DESCRIPTION
46-3107	Rack Holds 6 Magnum-Style Chisels

Note: Instruments not included.



46-3222

Karlin™ Magnum Instrument Racks

CODE	DESCRIPTION
46-3222	Rack for 12 XL Magnum Instruments
46-3407	Rack for 12 PG Magnum Instruments

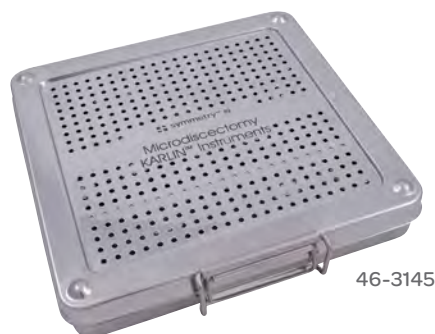

46-3145

Karlin™ Microdiscectomy Instrument Case

CODE	DESCRIPTION
46-3145	Case for 12 Lumbar Instruments
46-3175	Case for 12 Cervical Instruments



46-3037

Karlin™ Spanner & Gauge Instrument Case

CODE	DESCRIPTION
46-3037	Case for 5 Lumbar Spanners
46-3047	Case for 5 Cervical Spanners

Note: Instruments not included.

Please consult the product Instructions for Use, inserts and labels for specific information regarding intended use, contra-indications, warnings and cautions.

Questions? Contact us at customerservice@symmetrysurgical.com or learn more at symmetrysurgical.com

Specialty Trays



46-3066

Karlin™ Stiletto Osteotome Instrument Case

CODE	DESCRIPTION
46-3060	Case Holds 5 Curved Osteotomes
46-3066	Case Holds 5 Straight Osteotomes

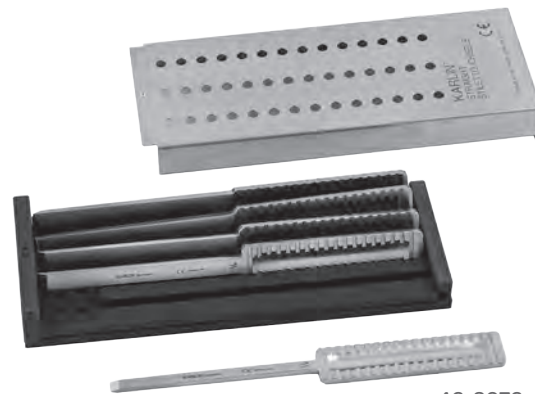

46-3076

Karlin™ Stiletto Instrument Case

CODE	DESCRIPTION
46-3086	Case for 5 Curved Chisels
46-3076	Case for 5 Straight Chisels



80-1599

Laparoscopic Instrument Tray

CODE	DESCRIPTION
68-1599	Instrument Tray
68-1598	Pin Mat for Laparoscopic Instrument Tray

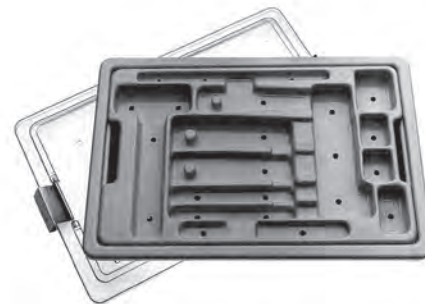

Microcare® I.M.A. Instrument Case

2 Levels for Storage

CODE	DESCRIPTION
80-1865	Includes Base, Tray Top and Lid

Please consult the product Instructions for Use, inserts and labels for specific information regarding intended use, contra-indications, warnings and cautions.

Questions? Contact us at customerservice@symmetrysurgical.com or learn more at symmetrysurgical.com

Specialty Trays

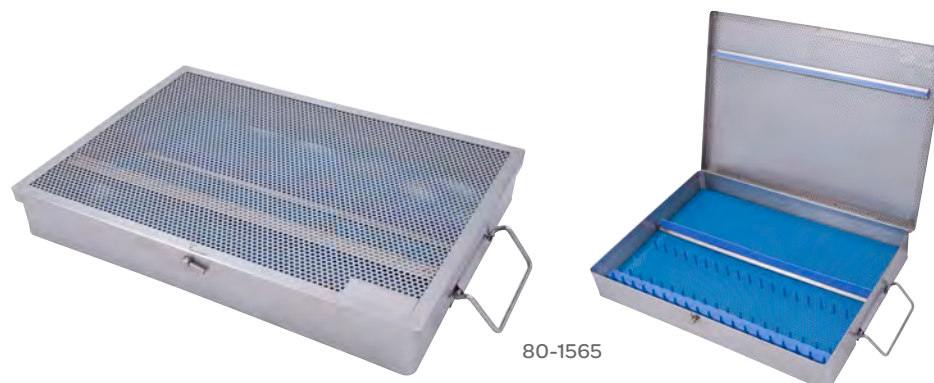

80-1565

Microcare® Cases

CODE	DESCRIPTION	DIMENSIONS	
80-1563	Microcare® Instrument Case, Small	10.5 in	267 mm
80-1562	Microcare® Instrument Case, Large	15 in	38 cm
80-1564	Microcare® Bayonet Case, Removable Lid, Small	10.5 in	267 mm
80-1565	Microcare® Bayonet Case, Removable Lid, Large	15 in	38 cm
80-1567	Microcare® Combo Instrument Case	15 in	38 cm



80-1580

Microcare® Large Modular Instrument Case

Holds 4 Color-Coded Trays, Each w/ 20 Individual Compartments, and has Room for up to 8 Neurosurgical Clip Appliers

CODE	DESCRIPTION	DIMENSIONS	
80-1580	Large Set Includes:		
80-1594	One Base Tray and Lid	21 x 13 x 1 in	533 x 330 x 25 mm
80-1581	Blue Tray	9.5 x 5.5 x 0.5 in	241 x 140 x 13 mm
80-1582	White Tray	9.5 x 5.5 x 0.5 in	241 x 140 x 13 mm
80-1583	Gray Tray	9.5 x 5.5 x 0.5 in	241 x 140 x 13 mm
80-1584	Black Tray	9.5 x 5.5 x 0.5 in	241 x 140 x 13 mm

Please consult the product Instructions for Use, inserts and labels for specific information regarding intended use, contra-indications, warnings and cautions.

Questions? Contact us at customerservice@symmetrysurgical.com or learn more at symmetrysurgical.com

Specialty Trays

Microcare® Small Modular Instrument Case

Holds 2 Color-Coded Trays, Each w/ 20 Individual Compartments, and has Room for up to 4 Neurosurgical Clip Appliers

CODE	DESCRIPTION	DIMENSIONS	
80-1595	Small Set Includes: One Base Tray and Lid, Holds 2 Trays, Each with 20 Compartments	9.5 x 5.5 x 0.5 in	241 x 140 x 13 mm

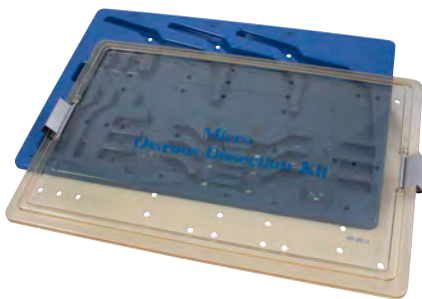

Microcare® Osseous Dissection Instrument Case

CODE	DESCRIPTION
46-2613	Tray and Lid



Microcare® Universal Bayonet Instrument Case

CODE	DIMENSIONS	
80-1914	21 x 13 x 1.5 in	533 x 330 x 38 mm



Microcare® Universal Straight Instrument Case

Case and Lid for 10 Instruments

CODE	DIMENSIONS	
80-1568	12 x 10.5 x 1.75 in	305 x 267 x 44 mm

Microsect® Curette Tray

CODE	DESCRIPTION
47-5023	Tray and Lid for 12 Instruments

Please consult the product Instructions for Use, inserts and labels for specific information regarding intended use, contra-indications, warnings and cautions.

Questions? Contact us at customerservice@symmetrysurgical.com or learn more at symmetrysurgical.com

Specialty Trays



Microvasc Microcare® Instrument Case

CODE	DESCRIPTION
80-1818	Case and Lid



Noon Instrument Case

CODE	DIMENSIONS	
21-8015	12 x 9.75 x 2 in	305 x 248 x 51 mm



Plif II

CODE	DESCRIPTION
21-1006	Instrument Case

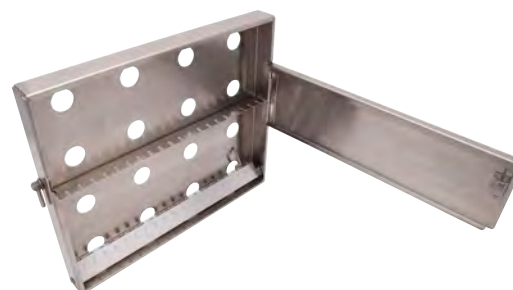

Rhoton® Sterilizing-Carrying Case

CODE	DESCRIPTION
80-1661	Sterilizing-Carrying Case



21-1003

Spinal Curette Storage & Sterilizing Case

Holds 9 Sizes of Curettes

CODE	DIMENSIONS	
21-1003	7 1/4 x 11 3/4 in	184 x 299 mm
21-1022	7 1/4 x 9 3/4 in	184 x 248 mm



Stainless Steel Dilator Case

CODE	SIZE	
21-8005	9 in	229 mm

Please consult the product Instructions for Use, inserts and labels for specific information regarding intended use, contra-indications, warnings and cautions.

Questions? Contact us at customerservice@symmetrysurgical.com or learn more at symmetrysurgical.com

Specialty Trays

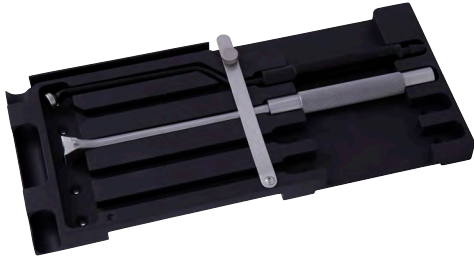

Sterilizing Case

For Spondylophyte Impaction Set

CODE	SIZE
46-3003	For Spondylophyte Impaction Set

Note: Instruments not included.



Sterilizing & Carrying Case

Holds 8 Gouges or Osteotomes

CODE	DIMENSIONS
21-1020	8 7/8 x 1 1/4 in 225 x 32 mm



21-3000

Sterilizing Tray

CODE	DESCRIPTION	SIZE
21-3000	Small, Depth 3 in	11 1/4 in 286 mm
21-3001	Medium, Depth 3 in	11 in 279 mm
21-3002	Large, Depth 3 in	21 3/4 in 552 mm



Sundt AVM Micro Clip Tray

Contains Soft Rubber Bars to Hold Individual Clips

CODE	DIMENSIONS
80-1840	11 x 7 x 1.75 in 280 x 180 x 45 mm



Sundt Slim-Line Graft Clip Tray

Contains Soft Rubber Bars to Hold Individual Clips

CODE	DIMENSIONS
80-1844	11 x 7 x 1.75 in 280 x 180 x 45 mm



Symmetry Instrument Case

Holds 8 Assorted 11 in (279 mm) Gouges or Osteotomes

CODE	DIMENSIONS
21-1020	11.25 x 8.875 x 2.25 in 298 x 225 x 64 mm

Please consult the product Instructions for Use, inserts and labels for specific information regarding intended use, contra-indications, warnings and cautions.

Questions? Contact us at customerservice@symmetrysurgical.com or learn more at symmetrysurgical.com

Sterilization Accessories



BUNTZ Forceps Holder

CODE	DESCRIPTION	LENGTH
28-4008	12 per Package	3.875 in 9.8 mm



Count Sheet Holder

CODE	DESCRIPTION	QTY
CSH-10	Self Adhesive Count Sheet Holder	10/Pk
CSH-50	Self Adhesive Count Sheet Holder	50/Pk
CSH-100	Self Adhesive Count Sheet Holder	100/Pk



ST-6



ST-8



ST-10

Instrument Stringers

Durable Stainless Steel Construction with a Secure Pin-Lock Design that Opens to 180°

CODE	DESCRIPTION	WIDTH	CODE	DESCRIPTION	WIDTH
ST-6	6 in Stringer	2.5 in 6.3 cm	ST-14	14 in Stringer	2.5 in 6.3 cm
ST-8	8 in Stringer	2.5 in 6.3 cm	ST-16	16 in Stringer	2.5 in 6.3 cm
ST-10	10 in Stringer	2.5 in 6.3 cm	ST-18	18 in Stringer	3 in 7.6 cm
ST-12	12 in Stringer	2.5 in 6.3 cm	ST-20	20 in Stringer	3 in 7.6 cm



79-0004

MESH Burr Holder

CODE
79-0003
79-0004



PPR

Peel Pouch Rack

CODE	DESCRIPTION	QTY
PPR	Peel Pouch Rack (Includes 2 Narrow and 2 Wide Brackets)	
PPR-N	Peel Pouch Brackets, Narrow	2/Pk
PPR-W	Peel Pouch Brackets, Wide	2/Pk

Please consult the product Instructions for Use, inserts and labels for specific information regarding intended use, contra-indications, warnings and cautions.

Questions? Contact us at customerservice@symmetrysurgical.com or learn more at symmetrysurgical.com

Sterilization Accessories

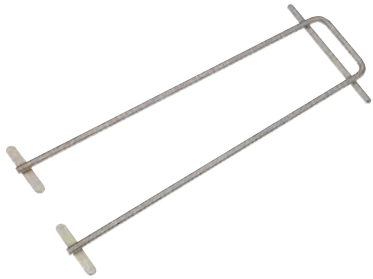

Rhode Island Hospital Instrument Holder

CODE	DESCRIPTION	LENGTH
21-4003	Instrument Holder	12 in 305 mm



30

Silicone Coarse Pin Mat

CODE	DESCRIPTION	DIMENSIONS
30	Non-Perforated	10 x 18 in 254 x 457 mm
30P	Perforated	10 x 18 in 254 x 457 mm

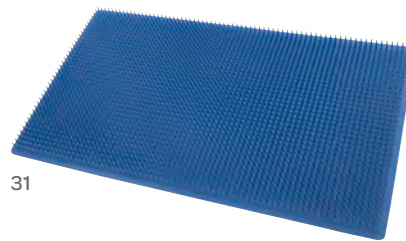

31

Silicone Fine Pin Mat

CODE	DESCRIPTION	DIMENSIONS
31	Non-Perforated	10 x 18 in 254 x 457 mm
31P	Perforated	10 x 18 in 254 x 457 mm



SURG-I-BAND Instrument Marking Tape

0.25 x 244 in (6 x 620 mm) Roll

BLACK	BLUE	BROWN	GREEN	ORANGE	RED	WHITE	YELLOW
43-4020	43-4021	43-4022	43-4023	43-4024	43-4025	43-4026	43-4027

Please consult the product Instructions for Use, inserts and labels for specific information regarding intended use, contra-indications, warnings and cautions.

Questions? Contact us at customerservice@symmetrysurgical.com or learn more at symmetrysurgical.com

Sterilization Accessories



Symmetry Instrument Lubricant

CODE	DESCRIPTION
26-5026	Lubricant, Sold as 1 Each



Symmetry Preserve® Lubricant

CODE	DESCRIPTION
43-1033	Concentrate, Anti-Microbial Lubricant, Supplied 4 Gallons per Case

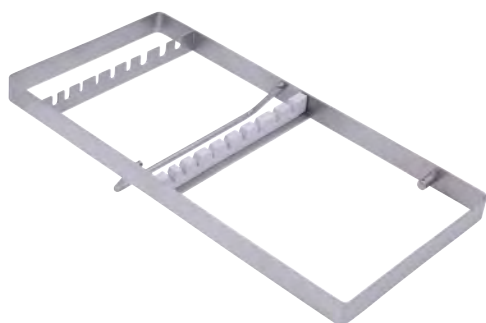

Vertebral Body Biopsy Rack

CODE	DESCRIPTION
24-2510	Biopsy Case



28-4010

Weisenbach Forceps Holder

CODE	DESCRIPTION	DIMENSIONS	
28-4010	Forceps Holder	6 in	152 mm
28-4011	Forceps Holder	12 in	305 mm

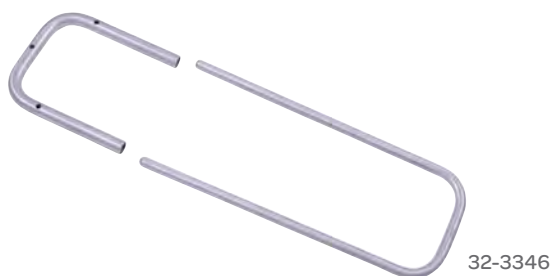

32-3346

Weinstein Rack

Sterilization for Ring Handle Forceps

CODE	DIMENSIONS	
32-3345	12 x 3 in	305 x 76 mm
32-3346	5.875 x 3.125 in	150 x 80 mm
32-3347	7.875 x 3.125 in	200 x 80 mm
32-3348	9.875 x 3.125 in	250 x 80 mm



Wire Instrument Rack

CODE	SIZE	
21-4002	4 ¼ in	108 mm

Please consult the product Instructions for Use, inserts and labels for specific information regarding intended use, contra-indications, warnings and cautions.

Questions? Contact us at customerservice@symmetrysurgical.com or learn more at symmetrysurgical.com

A

ACCESS

Curettes ENT-13
Nasal Forceps..... ENT-56
Punches..... ENT-99-100

ACORNS..... OBGYN-29-30

ADAIR

Breast Clamp..... CVT-18, GEN-5
Tenaculum Forceps OBGYN-53
Uterine Tenaculum Clamp OBGYN-2

ADAIR-ALLIS

Tissue Forceps..... GEN-77

ADENOTOMES

Tonsil & Laryngeal..... ENT-2

ADSON

Artery Forceps..... CVT-72, GEN-27
Bipolar Forceps ... ENG-8, ENG-21, ENT-39, GEN-34
Cranial Rongeur..... NEU-105, SPN-136
Dissecting Hook..... NEU-44, OBE-35, SPN-67
Dressing Forceps CVT-77-79, GEN-43, GEN-114,
NEU-31
Drill Guide & Dura Protector NEU-19
Dura & Nerve Hook..... ENT-65
Dura Hook..... GEN-126, NEU-44
Dural Needle Holder GEN-152, NEU-59
Elevator NEU-22
Forceps..... ENG-60, GEN-77, PED-9, PED-46
Ganglion Scissors GEN-283, NEU-114
Hemostatic Forceps..... CVT-84, CVT-99, CVT-115,
GEN-52-53
Hypophyseal Forceps GEN-31, NEU-33
Monopolar Forceps..... ENG-29
Periosteal Elevator GEN-22, O/A-21, SPN-48
Retractors..... GEN-213, GEN-239, NEU-83, RET-37,
SPN-133
Suction Tube..... GEN-314, NEU-131
Tissue Forceps..... CVT-99, CVT-104, CVT-108,
GEN-77-78, GEN-101, GEN-114

ADSON-BROWN

Tissue Forceps. CVT-100, GEN-77, GEN-79, PED-46

ADSON CUSHING

Bayonet Forceps..... GEN-33

ADSON-GRAEFE (BEASLEY)

Tissue Forceps..... GEN-79

ADSON KELLY

Ganglion Scissors ENT-127, GEN-283

ADVENTITIA

Micro Scissors GEN-288

AEBLI

Corneal Scissors OPH-50

AGRICOLA

Lacrimal Sac Retractor RET-76

AIR HOSES..... CVT-63, NEU-6

ALDERDYCE

Elevator ENT-27

ALEXANDER

Chisel..... O/A-3, SPN-4
Gouge O/A-43, SPN-63

ALEXANDER-FARABEUF

Raspatory CVT-137, PED-22

ALFONSO

Newborn Eye Speculum..... OPH-69

ALLEN

Intestinal Clamp GEN-4
Intestinal Forceps..... GEN-62

ALLEN-KOCHER

Artery & Intestinal Forceps..... GEN-31

ALLIS

Atraumatic Grasping Forceps..... LAP-68, LAP-83
Grasper..... ENG-40
Grasping Forceps LAP-34, LAP-53, LAP-62, LAP-74
Tissue Forceps..... CVT-100, GEN-79-80, OBE-30,
PED-16, PED-47
Tissue Grasping Forceps LAP-45

ALLIS-ADAIR

Tissue Forceps..... CVT-100, GEN-80

ALLIS-COAKLEY

Tonsil Forceps ENT-62

ALLIS WILLAUER

Forceps..... GEN-92

ALLISON

Lung Retractor CVT-166, GEN-214, RET-74

ALLPORT

Mastoid Hook & Searcher ENT-20

ALM

Retractors... CVT-172, ENT-113, GEN-240, GEN-245,
PED-26, PED-28, RET-64
Self-Retaining Retractor NEU-83

AMERICAN

Bear Claw Retractor RET-98
Umbilical Scissors..... GEN-302, OBGYN-43

ANDERSON-ADSON

Scalp Retractor..... GEN-240, NEU-81, RET-105

ANDERSON-NEIVERT

Osteotome ENT-86

ANDREWS BABCOCK

Forceps..... LAP-18

ANDREWS-PYNCHON

Suction Tube... CVT-223, GEN-315, OBE-79, OBE-81

ANIS

Lens Holding Forceps..... OPH-11
Needle Holder OPH-41

ANKENEY

Sternal Retractor CVT-174-175, PED-30, RET-144

- ANTHONY**
Suction Tube..... GEN-315
- APFELBAUM**
Tear Drop Dissector..... NEU-14
- APPLICATORS**
Cotton.....GEN-2
- APPROXIMATORS**
Rib.....CVT-2, PED-2
- ARCH BARS**.....ENT-3
- ASCH**
Septum Straightening Forceps..... ENT-60
- ASPIRATORS**
Needle OBE-2
- ATKINSON**
Retrobulbar Needle.....OPH-3
- AUFRANC**
Cobra RetractorO/A-78, RET-89
- AUFRICHT**
Nasal RaspENT-101
Retractors..... ENT-106, RET-39, RET-89
- AUFRICHT-GLABELLA**
Rasp ENT-103
- AUSTIN**
Chisel.....ENT-5
ElevatorsENT-21, ENT-28
Excavator.....ENT-43
Foot Plate HookENT-43
Needle.....ENT-84
PickENT-91
Strut Calipers ENT-4
- AUVARD**
Weighted Vaginal Speculum..... OBGYN-46
- B**
-
- B.E. GLASS**
Abdominal Retractor GEN-183, RET-43
- BABCOCK**
Forceps..... GEN-62, GEN-81-82, OBE-30, OBE-34
Grasper..... ENG-40
Grasping ForcepsLAP-36, LAP-45, LAP-62,
LAP-68, LAP-75-76, LAP-83
Grasping Forceps with DeBakey Teeth..... LAP-53
Laparoscopic Forceps.....LAP-9-11, LAP-21, LAP-36
- BACKHAUS**
Towel Clamp GEN-12
- BACON**
Cranial Rongeur NEU-105, SPN-136
- BADGLEY**
Laminectomy RetractorRET-122, SPN-119
- BAILEY**
Aortic Rongeur..... CVT-187
Rib Approximator CVT-2, PED-2
- BAILEY-GIBBON**
Rib ApproximatorCVT-2
- BAILEY GIGLI**
Saw Guides..... NEU-110
- BAINBRIDGE**
Artery & Intestinal Forceps GEN-31
- BAIRD**
Chalazion Forceps..... OPH-11
- BAKES**
Common Duct Dilator Set GEN-19
- BALFOUR BLADES**
Bookwalter® CVT-141, GEN-186
Retractor Blades.....GEN-177, GEN-179-181,
OBE-52-53
Supra-Pubic Retractor Blade..... OBE-45
- BALFOUR RETRACTORS**
Abdominal..... GEN-177, OBE-43, OBE-51, PED-29,
RET-2-7
Complete GEN-178, RET-6
Fenestrated CVT-171, GEN-178, GEN-181-183,
RET-6-7
Fourth ArmGEN-181, OBE-44
PediatricCVT-173, GEN-182
- BALLENGER**
Chisel..... ENT-6
Swivel Knife ENT-78
- BALLENTINE**
Hysterectomy Forceps.....GEN-82, OBGYN-15
- BANE**
Bone Rongeur O/A-94
- BARNES-CRILE**
Classic® Forceps CVT-114, GEN-83
- BARNHILL**
Adenoid CuretteENT-9
- BARON**
Obturator..... GEN-316
Suction Tube..... GEN-315
- BARR**
Anal Retractor.....REC-5
Anal Speculum..... RET-99
Fistula Probe.....REC-3
- BARRAQUER**
Cilia Forceps OPH-11
Cyclodialysis Spatula OPH-67
Eye Speculum OPH-69, PED-43
Iris ScissorsOPH-50
Iris Spatula.....OPH-67
Needle Holders.....OPH-41, OPH-43
- BARRETT**
Tenaculum Forceps.....OBGYN-54
- BARSKY**
Skin Hook ENT-69, GEN-127

- BARTLEY**
Classic® Anastomosis Clamp CVT-6, PED-2
- BARTON**
Obstetrical Forceps OBGYN-20
- BAUMGARTNER**
Needle Holders CVT-127, GEN-152, PED-19-20
- BEALL**
Circumflex Scissors CVT-190
- BECHERT**
Lens Nucleus Rotator OPH-27, OPH-37
- BECHERT-HOFFER**
Nucleus Rotator OPH-49
- BECHERT-MCPHERSON**
Tying Forceps OPH-11
- BECK-COOLEY**
Vascular Clamp CVT-47
- BECKER**
Aorta Clamp CVT-9, CVT-13
Septum Scissors ENT-132
- BECKMAN**
Retractor GEN-240, OBE-66
- BECKMAN-ADSON**
Laminectomy Retractor GEN-241, OBE-65,
RET-122, SPN-120
- BECKMAN-EATON**
Laminectomy Retractor GEN-241
- BEEBEE**
Wire Scissors GEN-308
- BEESON**
Plaster Spreader O/A-2
- BELLUCCI**
Alligator Forceps ENT-44
Alligator Scissors ENT-123
Ear Suction Tube ENT-145
Miniature Scissors ENT-129
Retractor RET-64
- BELLUCCI-WULLSTEIN**
Retractor ENT-111, RET-64
- BENNETT**
Bone Retractor O/A-78, RET-89
- BENSON**
Pyloric Stenosis Spreader Retractor GEN-237
- BERENS**
Mastectomy Retractor RET-74
- BERGMANN**
Bandage Scissors GEN-255
- BERGMANN-FORESTER**
Sponge Forceps GEN-71
- BERKE**
Ptosis Forceps OPH-12
- BERKE-JAEGER**
Lid Plate OPH-45
- BERLIND-AUVARD**
Vaginal Weighted Speculum OBGYN-46
- BETHUNE**
Rib Shears CVT-216
- BEYER**
Rongeurs ENT-118, ENT-120, NEU-85, O/A-95,
SPN-136
- BIERER**
Ovum Forceps OBGYN-22
- BILLEAU**
Ear Loop ENT-79
- BINKHORST**
Irrigating Cannula OPH-3
Lens Forceps OPH-12
- BIOPSY NEEDLES**
Vertebral SPN-2
- BISHOP**
Bone Forceps O/A-35
Chisel O/A-4, SPN-4
Gouge O/A-43, SPN-64
- BISHOP HARMON**
Forceps GEN-83-84, OPH-12, PED-45
Irrigating Cannula OPH-3
- BLACK**
90° Dural Suction Retractor GEN-242
- BLADES**
See also BALFOUR BLADES; BOOKWALTER®
BLADES; RETRACTOR BLADES
Ophthalmologic OPH-2
Temporary Clip NEU-2
- BLAIR**
Cleft Palate Elevator ENT-20
- BLAIR (ROLLET)**
Retractor ENT-106, RET-43
- BLAKE**
Gall Stone Forceps GEN-50
- BLAKESLEY**
Nasal Forceps ENT-56
- BLAYDES**
Lens Holding Forceps OPH-12
- BLOCK POTTS**
Intestinal Clamp GEN-4
- BLOUNT**
Hip Retractor O/A-78, RET-92
Knee Retractor O/A-89
- BLUMENTHAL**
Rongeur ENT-120, O/A-95
- BOELHER**
Wire & Pin Traction Bow O/A-111

BOETTCHER

Tonsil Scissors.....ENT-135

BOIES

Nasal Fracture Elevator..... ENT-24

BOLEY

Retractor..... CVT-178, GEN-216, RET-44

BONACCOLTO

Forceps.....OPH-13

BONE WAXERS

Cervical.....SPN-2

BONN

Iris Hook.....OPH-27

Suture Forceps..... GEN-73

BONNEY

Tissue Forceps..... CVT-101, GEN-84

BOOKWALTER®**BOOKWALTER® ACCESSORIES**

Laparoscopic Support Set.....LAP-23, RET-73

Obese Patient Accessory Kit..... CVT-148, GEN-195,
OBE-61, RET-19

Rectal Accessory Kit.....REC-4, RET-100

BOOKWALTER® BARS

Gooseneck Horizontal..... GEN-184

Horizontal..... OBE-53, OBGYN-37

I.M.A. Crossbar.....CVT-160, RET-34

I.M.A. "T" Bar.....CVT-149, CVT-161

Ironman.....CVT-140, GEN-185, RET-8

Lightweight Extension .CVT-140, GEN-186, OBE-53,
RET-9Lightweight Horizontal CVT-140, GEN-185,
GEN-186, OBE-44, OBE-53, RET-8-9Lightweight Horizontal FlexCVT-140, GEN-185,
OBE-44, RET-8

Vertical Extension SPN-113

BOOKWALTER® BLADES

Balfour Blade..... CVT-141, GEN-186, OBE-53, RET-9

Gelpi Blade CVT-143, GEN-186, RET-9

Harrington Retractor Blade.....

CVT-141, CVT-157, GEN-187, OBE-47, OBE-54,

RET-10, RET-28, RET-29, RET-143

I.M.A. Retractor Blade..... CVT-161, RET-34

Kelly Blade CVT-141, CVT-157, CVT-181,

GEN-187, GEN-226, OBE-48-49, OBE-54, RET-10,

RET-29, RET-51

Malleable Retractor Blades..... CVT-142, GEN-189,

OBE-54, RET-12

Opti-Length® Retractor Blade..... CVT-142, GEN-188,

OBE-54, RET-10

Radiolucent Titanium Blade..... CVT-143, OBE-55,

RET-13

Rake RetractorRET-11, GEN-187

Retractor Blades..... CVT-142, GEN-189, GEN-190,

OBE-55, RET-12

Richardson Blade.....CVT-141, GEN-188, RET-11

Scoville Hook GEN-188, RET-11

BOOKWALTER® CASES

I.M.A. Retractor Case..... CVT-161, RET-35, SS-37

Retractor Blades and Accessories Case..... CVT-162,
SS-37

Spinal Retractor Case SS-37

Table Fix & Ring CaseCVT-163, GEN-212, SS-37

BOOKWALTER® INSTRUMENT HOLDERTelescopic Laparoscopic Holder..GEN-210, OBE-37,
RET-73**BOOKWALTER® KITS**Obese Patient Kits..... GEN-193-194, RET-17-18,
RET-20

Retractor Kit II CVT-144, GEN-191, RET-14

Retractor Kit IIIRET-15

Richardson Blade Kit CVT-149, CVT-149,GEN-195,
RET-20

Small Incision KitCVT-145, GEN-192, RET-16

Spinal Retractor KitSPN-112-13

BOOKWALTER® POST COUPLING

Bookwalter® Coupler.....OBGYN-37

Lightweight Post Coupling.....CVT-143, GEN-190,
OBE-60, RET-13**BOOKWALTER® RATCHETS**

Flat Ratchet.....OBE-56, RET-22

I.M.A. Ratchet CVT-161, RET-35

Ratchet Extender CVT-151, GEN-198, OBE-56,
RET-24

Ratchet Key OBGYN-38

Ratchet Mechanism CVT-150, GEN-196

Rotilt Ratchet..... CVT-150, GEN-197, RET-22

Self-Retaining Low Profile Locking Rotilt CVT-151,
GEN-197, OBE-56, RET-23Self-Retaining Tilt RatchetCVT-150, GEN-197,
OBGYN-38, OBE-57, RET-23

Tilt RatchetCVT-150, OBGYN-37, RET-22

Tilt Ratchet Mechanism.....GEN-196, OBE-57

Twister Ratchet CVT-151, GEN-198, OBE-57, RET-23

BOOKWALTER® RINGS

Elliptical Ring... CVT-152, GEN-199, OBE-58, RET-24

Oval Ring..... CVT-153, GEN-200, OBE-58, RET-25

Relvic Rings.....OBGYN-38

Round Ring..... CVT-153, GEN-200, OBE-58, RET-25

Round Suture Ring..... GEN-201

Segmented Elliptical Ring RET-24

Segmented Retractor Ring..... CVT-154, GEN-201,
OBE-58, RET-25-26

Segmented Round Ring CVT-153, GEN-200, RET-25

Straight Ring Segments . CVT-154, GEN-201, RET-26

Suture Ring.....CVT-153, GEN-201, RET-25

Universal Ring Segmented Ring Screw..... CVT-154,
RET-26**BOOKWALTER® SYSTEMS**Adaptable Ring System CVT-152, GEN-199, OBE-63,
RET-24Adaptable Ring System Bridge CVT-152, GEN-199,
OBE-63, RET-24

Anterior Lumbar Retractor SystemRET-137, SPN-113

I.M.A. Retractor System ..CVT-149, CVT-161, RET-35

Obese Patient Retractor System..CVT-146, CVT-147,
OBE-60, OBE-62Universal Flex Arm System..... GEN-211, OBE-37,
RET-73

- Universal Flex Arm..... LAP-23
- BOOKWALTER® TABLE POSTS**
 Lightweight Table Post CVT-155, GEN-203, OBE-64,
 RET-28
 Post Holder GEN-202, RET-27
 Table Posts CVT-155, GEN-202-203, OBE-64,
 OBGYN-39, RET-27
 Violi Gooseneck..... CVT-155, RET-8
 Violi Post Holder CVT-155
- BOOKWALTER®-MAGRINA**
 Deaver Blade OBGYN-36, RET-151
 Lateral Blade..... OBGYN-36, RET-151
 Posterior Blade..... OBGYN-36, RET-151
 Retractor Blade OBGYN-36, RET-13
 Retractor System..... OBGYN-35-39
 Vaginal Retractor System OBGYN-35, RET-152
- BOOKWALTER®-MEYERDING**
 Retractor Blade GEN-188, RET-11
- BORES**
 Markers OPH-39
- BORGE**
 Cystic Duct Clamp..... GEN-4
- BOSTON LYING-IN**
 Cervical Grasping Forceps..... GEN-84, OBGYN-14
- BOTVIN**
 Iris Forceps OPH-13
- BOUCHERON**
 Speculum..... ENT-143
- BOWMAN**
 Probes GEN-176, OPH-45, PED-21
- BOYS-ALLIS**
 Tissue Forceps..... GEN-85
- BOZEMAN**
 Dressing Forceps CVT-28
 Uterine Dressing Forceps GEN-44, GEN-117,
 OBGYN-23
- BRACKEN**
 Anterior Chamber Cannula..... OPH-4
 Iris Forceps OPH-13
- BRACKMAN**
 Suction Tube..... GEN-316
- BRAND**
 Suction Tube..... GEN-316
- BRAUN**
 Episiotomy Scissors GEN-282, OBGYN-42
 Tenaculum Forceps OBGYN-54
- BREISKY**
 Vaginal Retractor OBGYN-40, RET-153
- BRIDGE**
 Deep Surgical Forceps..... CVT-77, OBE-24
 Forceps CVT-115, GEN-85
- BRIGHAM**
 Brain Tumor Forceps..... GEN-86, NEU-30
- Tissue Forceps..... CVT-101, GEN-86
- BRINKERHOFF**
 Rectal Speculum..... REC-7, RET-99
- BRISTOW-BANKART**
 Humeral Retractor O/A-79, RET-94
- BROPHY**
 Scissors ENT-136
- BROWN**
 Dissecting Scissors ENT-124
 Needle Holders..... GEN-153
 Tissue Forceps..... CVT-101, GEN-86, OBE-31
- BROWNE**
 Deltoid Retractor O/A-78
- BRUENING**
 Nasal Snare ENT-138
 Septum Forceps..... ENT-60
- BRUNS**
 Curette..... NEU-6-7, O/A-14-15, SPN-29-33
- BRUSHES**
 Laryngoscope Cleaning..... ENT-3
- BUCK**
 Ear Curette..... ENT-11
- BUCY**
 Cordotomy Knife..... NEU-54
- BUIE**
 Fistula Probe..... REC-3
 Pile Clamp GEN-11, GEN-68
- BUMM**
 Uterine Curette..... OBGYN-6
- BUNGE**
 Evisceration Spoon OPH-72
- BUNNELL**
 Hand Drill..... NEU-20
- BUNT**
 Forceps Holder GEN-310, SS-45
 Instrument Holder..... CVT-220

- BURFORD**
 Rib Retractor CVT-168, PED-26
- BURFORD-FINOCHIETTO**
 Rib Retractor RET-103
 Rib Spreader CVT-219
- BURR HOLDER**
See also DRILLS
 Wire Mesh CVT-62
- BUSCH**
 Umbilical Scissors..... GEN-302, OBGYN-44

C

CABLES

Bipolar LAP-31

CALIPERS

ACF SPN-2
 Middle Ear ENT-4
 Neuro NEU-2
 Ophthalmologic OPH-2
 Patella O/A-2

CALLISON

Tissue-Tying Forceps GEN-114

CAMPBELL

Nerve Root Retractor GEN-217, RET-133, SPN-130

CANFIELD

Tonsil Knife ENT-78

CANNULAS

Brain NEU-2
 Heparin I.M.A. GEN-3
 I.M.A. CVT-3
 Irrigating/Aspirating LAP-26
 Ophthalmologic OPH-3-7
 Sinus & Nasal ENT-4-5
 Suction/Irrigating GEN-3
 with Trocar ENT-5
 Uterine OBGYN-29-30

CAPLAN

Septum Scissors ENT-132

CARMALT

Artery Forceps CVT-73, GEN-27

CARROLL

Periosteal Elevator GEN-22, NEU-22, O/A-22,
 PED-8, SPN-48
 Skin Hook NEU-51, PED-18
 Tendon-Pulling Forceps GEN-75, NEU-38

CASES See BOOKWALTER® CASES; INSTRUMENT CASES

CASPAR

Bone Tamp O/A-109, SPN-191
 Cervical Retractor SPN-113
 Cervical Vertebral Body Distractor SPN-42
 Curette NEU-8, SPN-33
 Distraction Pin SPN-42, SPN-95
 Distractor SPN-43
 Exploration & Coagulation Hook NEU-46
 IVD Rongeur NEU-91
 Lateral Blade SPN-109
 Lumbar Speculum RET-124
 Medial Radiolucent Carbon Fiber Blade SPN-132
 Micro Dissector NEU-13
 Nerve Root Retractor RET-133
 Retractor SPN-97
 Retractor Blade Ejector SPN-109
 Rongeur NEU-92, SPN-143-144
 Screw Driver SPN-47
 Twist Drill Bit SPN-46

CAST TOOLS

Breaker O/A-2
 Plaster O/A-2

CASTANEDA

Anastomosis Clamp CVT-6
 Clamps CVT-50, PED-2, PED-3, PED-4
 Forceps PED-16, PED-49
 Infant Sternal Retractor CVT-165, PED-24-25
 Instrument Kit/Case CVT-33, CVT-56, RET-144,
 SS-37
 Multi-Purpose Clamp CVT-94
 Partial Occlusion Clamp CVT-38
 Suture Tag Forceps CVT-97, GEN-74
 Vascular Forceps CVT-112, GEN-86

CASTANEDA-MIXTER

Thoracic Clamp CVT-4, GEN-11, PED-5

CASTROVIEJO

Caliper OPH-2
 Classic Plus® Needle Holders CVT-127
 Forceps OPH-14
 Heavy Needle Holder (Jacobson Style) GEN-139
 Lacrimal Dilator OPH-10
 Micro Scissors GEN-289
 Microsurgical Needle Holder GEN-143
 Needle Holders CVT-123, GEN-153-154,
 OPH-41-42, PED-19
 Scissors OPH-50-52, PED-33
 Spatulas OPH-67
 Speculum OPH-69
 Suture Forceps GEN-73, GEN-74

CASTROVIEJO-RYDER

Needle Holders GEN-154

CATALANO

Intubation Set OPH-34

CATHETERS

URO-3

CEMENT IMPACTION

Tibial O/A-2-3

CHAMBERLAIN-FRIES

Hook GEN-126

CHANDLER

Elevator O/A-19, SPN-48

CHARNLEY

Retractor Blades GEN-242
 Retractors GEN-243, RET-92-93

CHELSEA-EATON

Anal Speculum REC-7

CHERRY

Osteotome SPN-86
 Secto® Dissectors GEN-21
 Supraceliac Clamp CVT-44

CHILDREN'S HOSPITAL

Classic® Dressing Forceps CVT-79, GEN-44, PED-9
 Retractors CVT-178, GEN-217, PED-24, RET-44

CHISELS

Acetabular O/A-3
 Bone O/A-3-7, SPN-3

- Cervical.....SPN-3
 General Purpose..... OBE-2, SPN-4-7
 Lamina.....SPN-3
 Middle Ear, Sinus & Nasal..... ENT-5-6
 Spinal Fusion.....SPN-3
 Stiletto..... OBE-2, SPN-6
- CHURCH**
 Artery Scissors.....CVT-188
 Vascular Scissors.....CVT-208
- CINELLI**
 Double Guarded Osteotome.....ENT-88
 Lower Lateral Scissors..... ENT-128
- CITELLI**
 Rongeur..... ENT-121
- CLAMP BOX**..... CVT-63
- CLAMPS**
See also FORCEPS
 Acutely Angled..... CVT-4
 Acutely Curved.....CVT-4-5
 Anastomosis..... CVT-5-8, CVT-32, CVT-36, OBE-3,
 PED-2
 Angiotribe.....GEN-3
 Aorta.....CVT-3, CVT-8-13, OBE-3
 Aortic Aneurysm..... CVT-4, OBE-3
 Approximator.....CVT-14-16
 Artery.....CVT-17
 Auricle..... CVT-17, CVT-53
 A-V Fistula..... CVT-17, PED-2
 Biopsy.....GEN-5
 Bone Holding.....O/A-7
 Breast..... CVT-18, GEN-5
 Bronchus..... CVT-18, GEN-41, OBE-4
 Bulldog..... CVT-19-23
 Carotid.....CVT-24, CVT-36
 Cartilage.....O/A-8
 Caval Occlusion..... CVT-24
 Cesarean Section..... OBGYN-2-3
 Chest Tube Puller/Passer.....CVT-25
 Circumcision.....OBGYN-3-4
 Coarctation..... CVT-25-27, OBE-4
 Cross-Action Bulldog.....CVT-27
 Cystic Duct..... GEN-4
 Delicate.....CVT-28
 Ductus.....CVT-29
 Femoral Popliteal.....CVT-29, CVT-32
 Gastrointestinal..... GEN-6
 General Purpose..... CVT-15, CVT-50-54
 Hemagrip..... CVT-29-30
 Hemostatic CVT-30-31, GEN-6-7, GEN-54, OBE-4,
 PED-3
 Hinge.....CVT-31
 Hypogastric.....CVT-31
 Hysterectomy.....GEN-7-8
 Iliac.....CVT-32, OBE-5
 Instrument Kit.....CVT-33
 Internal Fixation.....O/A-8
 Intestinal.....CVT-33, GEN-4, GEN-9, OBE-5
 Kidney.....GEN-9-10, URO-4
 Ligature Carrying..... CVT-34, OBE-6
 Liver..... CVT-34, GEN-10, OBE-6
 Meniscus.....O/A-9
 Micro-Coronary Bulldog.....CVT-35
 Miniature.....CVT-51
 Multi-Purpose.....CVT-50-54, PED-3
 Neonatal.....CVT-36, PED-4
 Obstetric..... OBGYN-2-4
 Occluding..... CVT-37-38
 Ophthalmologic..... OPH-8
 Patent Ductus.....CVT-38-39
 Pediatric.....CVT-39, PED-4-5
 Pelvic.....OBE-6, OBGYN-4
 Penile Meatus.....URO-4
 Peripheral Vascular.....CVT-40-41, CVT-52
 Pile.....GEN-11
 Profunda.....CVT-41
 Prostatectomy.....URO-4
 Pylorus.....GEN-11
 Renal.....CVT-42
 Right Angle.....PED-5
 Ring Handle Bulldog.....CVT-43
 Serrefine.....OPH-8
 Sinus & Nasal, Middle Ear.....ENT-7
 Spleno-Reno.....CVT-43
 Spoon-Shaped.....CVT-43
 Stay Suture.....CVT-44, PED-5
 Suction Tube.....GEN-4
 Supraceliac.....CVT-44
 Tangential.....CVT-28
 Tangential Occlusion.....CVT-44-45
 Thoracic CVT-35, CVT-45-46, CVT-99, GEN-11-12,
 OBE-7, PED-5
 Tibial Artery.....CVT-46
 Tissue.....GEN-5
 Towel.....GEN-12-14
 Tubing.....CVT-47, GEN-14-16
 Uterine.....OBGYN-2
 Vascular CVT-8, CVT-35, CVT-38-39, CVT-47-49,
 OBE-8, PED-6
 Vasectomy.....GEN-16
 Vena Cava.....CVT-49-50
 Vessel.....GEN-17
 Wire.....GEN-17
 Wire Holding.....PED-6 CVT-43
- CLARK**
 Clamp.....OBGYN-4
- CLAYMAN**
 Iris Hook.....OPH-28
- CLAYMAN-JAFFE**
 Lens Manipulating Hook.....OPH-28
- CLEVELAND CLINIC**
 Pediatric Clamp.....PED-4
 Renal Clamp.....CVT-42
- CLINTON PEDERSON**
 Vaginal Speculum.....OBGYN-47
- CLIPS**
 Aneurysm.....NEU-2-3
- CLOWARD**
 Blade.....PED-22
 Cervical Retractor.....SPN-115
 Double Hinge Retractor.....SPN-97
 Graft Impactor.....O/A-49

- Lamina Retractor RET-122
 Lamina Spreader SPN-185
 Opti-Length® Rongeur OBE-67, SPN-144
 Osteophyte Periosteal Elevator..... NEU-23
 Periosteal Elevator O/A-20, SPN-48
 Retractor Blade with Lip..... SPN-110
 Rongeur NEU-93
 Vertebra Spreader SPN-185
- COAKLEY**
 Antrum Curette ENT-17
- COBB**
 Curette..... O/A-15, OBE-9, OBE-10, SPN-33-35
 Elevator O/A-22, OBE-20-21, SPN-49-50
 Magnum Elevator SPN-52, SPN-54
 Osteotome..... O/A-62, SPN-86
 Spinal Gouge..... SPN-64-65
- COHAN**
 Needle Holder OPH-43
- COHEN**
 Acorn Cannula OBGYN-29
 Uterine Manipulator..... OBGYN-29
- COLIBRI**
 Forceps..... OPH-15
- COLIN LUCAE**
 Bone Mallet..... O/A-57
- COLLER**
 Forceps..... CVT-115, GEN-87,
- COLLER-CRILE**
 Artery Forceps..... CVT-73, GEN-29
- COLLIER**
 Modified Clamp CVT-35
 Modified Thoracic Clamp GEN-11, OBE-7
- COLLIN**
 Tongue Forceps..... GEN-116
 Retractor..... O/A-79
- COLLINS**
 Radiopaque Sternal Blades..... RET-145
 Retractor..... GEN-218, RET-44
 Sternal Retractor CVT-175
- COLVER**
 Tonsil Seizing Forceps..... ENT-63
- CONE**
 Laminectomy Retractor SPN-120
 Ring Curette NEU-10, SPN-17-18
 Scalp Retractor..... NEU-82
 Skull Punch NEU-63
 Ventricular Needle NEU-61
- CONNECTORS**
 Luer-Lock..... GEN-17
- CONNOR**
 Wand OPH-28
- CONTAINERS**
 Accessories O/A-13, SPN-7
 Arthroscope O/A-9
 Arthroscope & Cable..... O/A-9
- Bookwalter® CVT-55
 Delivery..... O/A-10
 Drill O/A-10
 Gouge & Osteotome..... O/A-10
 Instrument CVT-55-63
 Micro Instruments NEU-3-6
 Modular..... O/A-11
 MultiPak O/A-11
 Rongeur Rack..... O/A-11
 Silicone Support Bracket..... SPN-8
 Sterilization LAP-94-95, NEU-5
 Sterilization Case..... O/A-12, OBE-8-9, SPN-8-12
 Tray..... O/A-12-13
 Tray, Middle Ear..... ENT-8
- CONVERSE**
 Alar Retractor ENT-114
 Blade Retractor ENT-115
 Button End Knife..... ENT-72
 Dorsal Scissors ENT-125
 Double Edge Scissors..... ENT-126
 Nasal Retractor..... ENT-111
 Osteotome ENT-86
 Retractors..... RET-39, RET-44
 Single Guarded Osteotome..... ENT-88
 Skin Hook ENT-69, GEN-130, NEU-51
- CONVERSE-WILMER**
 Nasal Scissors ENT-130
- COOK**
 Eye Speculum..... OPH-70
- COOLEY**
 Acutely Curved Clamp..... CVT-4, CVT-5
 Anastomosis Clamps CVT-7, CVT-36
 Aorta Clamp..... CVT-9
 Atraumatic Clamp CVT-37
 Atrial Retractor CVT-139
 Bulldog Clamp..... CVT-19
 Cardiovascular Scissors..... CVT-189
 Caval Occlusion Clamps CVT-24
 Caval Occlusion Forceps CVT-77
 Clamps..... OBE-3, OBE-5, PED-3, PED-6
 Coarctation Clamps CVT-25
 Coronary Dilator CVT-68
 Cross-Action Bulldog Clamp..... CVT-27
 Iliac Clamps CVT-32
 Infant Sternal Retractor CVT-165
 Multi-Purpose Clamps..... CVT-51
 "My Scissor" Ceramic Coated Scissors GEN-303
 Needle Holders..... GEN-154
 Neonatal Clamps CVT-36
 Occlusion Clamp..... CVT-37
 Opti-Length® Left Ventricular Sump..... OBE-81
 Partial Occlusion Clamp..... CVT-38
 Patent Ductus Clamp CVT-38, CVT-39
 Pediatric Clamp CVT-39
 Peripheral Vascular Clamp CVT-40-41
 Renal Artery Clamp..... CVT-42
 Retractors..... PED-26, RET-33, RET-103, RET-145
 Rib Retractor CVT-168
 Right Angle Sump Suction Tube CVT-225
 Sternal Retractor CVT-175
 Tangential Occlusion Clamp..... CVT-45

- Vascular Clamps CVT-48
 Vascular Forceps GEN-119
 Vascular Tissue Forceps CVT-112, GEN-87
- COOLEY-DERRA**
 Anastomosis Clamp CVT-7-8
- CORDS**
 Air Hoses CVT-63, NEU-6
 Monopolar LAP-93
- CORWIN**
 Knife Handle GEN-131
- CORYLLOS**
 Rib Shears CVT-216, OBE-77-78
- COSGROVE**
 Dressing Forceps GEN-44
- COTTLE**
 Alar Retractor ENT-115
 Cartilage Crusher ENT-8
 Chisel ENT-6
 Columella Clamp ENT-7
 Dorsal Scissors ENT-125, ENT-126
 Double Hook ENT-64
 Elevator O/A-22, SPN-50
 Guarded Osteotome ENT-88
 Mallet ENT-79
 Micro-Serrated Scissors GEN-258
 Nasal Knife ENT-77
 Nasal Retractor ENT-112
 Nasal Speculum ENT-138
 Osteotome ENT-86
 Rasp ENT-103
 Retractor ENT-106, RET-39, RET-45
 Septum Elevator ENT-26
 Septum Speculum ENT-140
 Single Hook ENT-68
 Skin Elevator ENT-26
 Tenaculum Hook ENT-70, RET-45
- COTTLE-JANSEN**
 Rongeur NEU-109, O/A-96, SPN-136
- COTTLE-JOSEPH**
 Double Hook ENT-64
- COTTLE-KAZANJIAN**
 Cutting Forceps ENT-45
- COTTLE-MCKENTY**
 Elevator SPN-50
 Periosteal Elevator O/A-22
- COTTLE-NEIVERT**
 Retractor ENT-107, RET-45
- CRAFOORD**
 Coarctation Clamp CVT-25, OBE-4
 Coarctation Forceps CVT-76
 Lobectomy Scissors CVT-200
- CRAFOORD COLLER**
 Artery Forceps CVT-73, GEN-27
- CRAIG**
 Vertebral Biopsy Case SPN-9
 Vertebral Body Biopsy SPN-2
- Vertebral Body Biopsy Kit SPN-80
- CRAWFORD**
 Aorta Retractor RET-32
 Lacrimal Intubation Set OPH-34
- CRAWFORD (BENGER)**
 Retrieving Hook OPH-28
- CRAWFORD-COOLEY**
 Tunneler CVT-226
- CREGO**
 Elevator O/A-20, SPN-50
- CRILE**
 Artery Forceps CVT-74, GEN-29
 Baby Artery Forceps GEN-27
 Clamp CVT-51
 Classic® Mosquito Forceps CVT-86
 Forceps PED-1, PED-13
 Gasserian Ganglion Knife NEU-54
 Hemostatic Forceps CVT-85-86, GEN-53
 MagnaFree® Forceps CVT-118, GEN-115
 Retractors CVT-179, ENT-107, GEN-218, PED-24, RET-45
- CRILE-WOOD**
 Needle Holders CVT-128, GEN-155, OBE-38, OBE-40, PED-20
- CROCKARD**
 Bayonet Micro-Dissector SPN-39
 Hard Palate Retractor SPN-118
 Ligament Grasping Forceps SPN-61
 Mid-Facial Osteotomy Retractor Plate SPN-130
 Odontoid Peg Grasping Forceps SPN-62
 Pharyngeal Retractor SPN-132
 Retractor Blades SPN-110
 Retractors RET-108-112
 Suction Tube Holder SPN-190
 Tongue Retractor Blade SPN-135
 Transoral Instrument Case SS-37
 Transoral Instrument Set SPN-79
 Transoral Retractor Body SPN-135
- CRONIN**
 Cleft Palate Elevator ENT-21
- CROWE-DAVIS**
 Mouth Gag ENT-81
 Mouth Gag Blades ENT-81
- CRUSHERS**
 Cartilage ENT-8
- CULLER**
 Iris Spatula OPH-68
- CUPS**
 Iodine CVT-63
 Medicine CVT-64
- CURETTES**
 Adenoid ENT-9-10
 Antrum ENT-17-18
 Arthroscopic O/A-13
 Biopsy OBGYN-5
 Bone ENT-10, O/A-14-16, SPN-12-13

Cervical.....SPN-13-18
 Dermal.....GEN-18
 Double-Ended.....ENT-11
 Ear.....ENT-11-12
 with Elevator.....ENT-12
 Endometrial.....OBGYN-5-6
 Ethmoid.....ENT-14
 Frontal Sinus.....ENT-13
 General Purpose.....GEN-18, NEU-6-11, NEU-134,
 OBE-9-19
 Lumbar.....SPN-20-23
 Micro.....ENT-14, NEU-9, SPN-23
 Microdiscectomy.....SPN-22-23
 Middle Ear.....ENT-14-16
 Ophthalmologic.....OPH-8
 Pituitary.....NEU-9-10
 Placenta.....OBGYN-6
 Ring.....NEU-10
 Sinus & Nasal.....ENT-17-18
 Spinal.....OBE-11, OBE-16, OBE-19
 Spinal Fusion.....SPN-25-29
 Uterine.....OBGYN-6-9

CUSHING

Bayonet Bipolar Forceps.....ENG-14, GEN-37
 Bayonet Dressing Forceps.....CVT-80, GEN-44
 Bayonet Forceps.....GEN-31
 Bayonet Tissue Forceps.....CVT-101
 Bipolar Forceps.....ENG-9, ENG-22, ENT-36
 Brain Spatula.....NEU-123
 Brain Spatula-Spoon.....NEU-123
 Burr.....NEU-17
 Decompression Retractor.....GEN-218, SPN-116
 Dressing Forceps.....CVT-80, GEN-45, NEU-31,
 SPN-60
 Dural Hook.....NEU-45, PED-17
 Elevator.....CVT-70, O/A-23, OBE-20
 Forceps.....CVT-115
 Gasserian Ganglion Hook.....NEU-46, OBE-35, SPN-68
 Intervertebral Disc Rongeur.....NEU-94, PED-31,
 SPN-145-146
 Monopolar Forceps.....ENG-29
 Nerve Hook.....ENT-68, GEN-127, NEU-46
 Perforator Drill.....NEU-20
 Periosteal Elevator.....GEN-22, GEN-23, O/A-23,
 NEU-23, SPN-51
 Pituitary Spoon.....NEU-126
 Retractor.....CVT-179, GEN-218, NEU-76, OBE-45,
 OBE-67, RET-46, RET-117, RET-159
 Rongeur.....NEU-109, O/A-96, SPN-144
 Rongeur Delicate.....NEU-94
 Staphylorrhaphy Elevator.....GEN-23, NEU-26
 Tissue Forceps.....CVT-102, GEN-88, NEU-38
 Vein Retractor.....ENT-117, GEN-219, GEN-251,
 NEU-84

CUSHING-BROWN

Bayonet Tissue Forceps.....GEN-88

CUTTERS

Arthroscopic.....O/A-16
 Bone.....SPN-38
 Umbilical Cord.....OBGYN-9
 Wire and Pin.....CVT-227

CUTTING BLOCKS.....ENT-18

D**DAICOFF**

Vascular & Needle Pulling Forceps.....GEN-120

DALE

Femoral Popliteal Clamp.....CVT-29, CVT-32
 First Rib Rongeur.....CVT-188, OBE-70

DANDY

Classic® Scalp Forceps.....NEU-37
 Nerve Hook.....NEU-47, OBE-35, SPN-68
 Scalp Forceps.....GEN-88
 Trigeminal Scissors.....GEN-258, NEU-120

DARDICK

Artery Clamp.....CVT-17

DARLING

Popliteal Retractor.....CVT-167, RET-63

DARRACH

Retractor.....O/A-80, RET-46

DAVIDSON

Scapular Retractor.....CVT-171, GEN-219, PED-27,
 RET-107

DAVIDSON-ALEXANDER

Rib Raspatory.....CVT-137

DAVIS

Brain Spatula.....GEN-309, NEU-124, RET-76
 Nerve Separator/Spatula.....NEU-125
 Retractor.....GEN-219

DAWSON-YUHL-LEKSELL

Rongeur.....O/A-96

DAY

Ear Hook.....ENT-65

DE VILBISS

Rongeur.....NEU-109, O/A-96

DEAN

Cotton Applicator.....GEN-2
 Tonsil Scissors.....ENT-135

DEAVER

Baby Retractor.....GEN-216, GEN-220
 Obese Retractor.....CVT-180
 Operating Scissors.....CVT-203, GEN-291, PED-37
 Pediatric Retractor.....CVT-180
 Retractor Blade.....OBGYN-36
 Retractors.....CVT-179, GEN-220-221, OBE-46,
 PED-24, RET-43, RET-46-48

DEBAKEY

Abdominal Aorta Clamp.....CVT-3
 Acutely Curved Clamp.....CVT-5
 Aneurysm Clamp.....CVT-8, CVT-10
 Bulldog Clamps.....CVT-19, CVT-20, CVT-27, CVT-43
 Clamps.....CVT-52, OBE-3, OBE-8, PED-3, PED-5
 Classic® Patent Ductus & Peripheral Vascular Clamp
 CVT-39

- Classic® Peripheral Vascular Clamp CVT-40
 Coarctation Clamps CVT-26, CVT-27
 Endarterectomy Scissors CVT-198
 Forceps ENG-60
 Grasper ENG-41
 Grasping Forceps LAP-37-39, LAP-46-47,
 LAP-49-50, LAP-54-56, LAP-58-59, LAP-63,
 LAP-65, LAP-68-72, LAP-78-81, LAP-84-87
 Micro Forceps CVT-91
 Needle Holders GEN-145, GEN-156, OBE-38
 Needle Pulling Tissue Forceps CVT-103, GEN-89
 Opti-Length® Forceps CVT-94, GEN-121
 Pediatric Patent Ductus Clamp CVT-39
 Scissors CVT-204, CVT-208
 Suction Tube GEN-316
 Tangential Clamp CVT-28
 Tangential Occlusion Clamp CVT-44, CVT-45
 Thoracic Dissecting Forceps CVT-46
 Thoracic Tissue Forceps CVT-103, GEN-122
 Thoracoscopy Grasping Forceps CVT-84
 Tissue Forceps CVT-103, GEN-89, GEN-122,
 LAP-9, LAP-17, OBE-31
 Titanium Vascular Tissue Forceps GEN-114
 Vascular Clamps CVT-48, CVT-52
 Vascular Dilator CVT-65, CVT-68
 Vascular Forceps CVT-102, CVT-114, GEN-122,
 OBE-34
 Vascular Tissue Forceps CVT-113, GEN-120-121
- DEBAKEY-BAHNSON**
 Aorta Clamp CVT-9, CVT-10
- DEBAKEY CASTANEDA**
 Clamp CVT-52
- DEBAKEY-COLLIER**
 Tissue Forceps CVT-102, GEN-89, OBE-31
- DEBAKEY-COOLEY**
 Clamp CVT-53
- DEBAKEY-DERRA**
 Anastomosis Clamp CVT-8
- DEBAKEY-DIETHRICH**
 Vascular Forceps CVT-112, GEN-121, OBE-34,
 PED-16
- DEBAKEY-GERALD**
 Tissue Forceps CVT-107
- DEBAKEY-LIDDICOAT**
 Vascular Forceps CVT-11, GEN-122
- DEBAKEY-METZENBAUM**
 Scissors CVT-193, GEN-303, OBE-71
- DEBAKEY-POTTS**
 Scissors GEN-303
- DEBAKEY-POTTS-SMITH**
 Vascular Scissors CVT-208
- DEBAKEY-SEMB**
 Ligature Carrying Forceps CVT-34, OBE-28
- DECKER**
 Micro Rongeur NEU-108
 Microsurgical Forceps NEU-36
- Microsurgical Scissors CVT-202, NEU-117, PED-36
 Rongeur NEU-94, SPN-146
- DEL**
 Intervertebral Disc Rongeur NEU-95
- DELABORDE**
 Tracheal Dilator PED-6
- DELASHAW**
 Bayonet Bipolar Forceps ENG-5
- DELEE**
 Obstetrical Forceps OBGYN-21
 Universal Retractor OBE-66, OBGYN-40, RET-49
- DEMARTEL**
 Scissors CVT-209, GEN-259
- DEMOS**
 Tibial Artery Clamp CVT-46
- DENHARDT**
 Mouth Gag ENT-83
- DENNIS**
 Intestinal Clamp GEN-9, OBE-5
 Micro Forceps CVT-91
- DENTALPAK** SS-17
- DEPRESSORS**
 Ophthalmologic OPH-9
 Tongue GEN-19
- DERF**
 Classic Plus® Needle CVT-128
 Needle Holder GEN-157
- DERF (WEBSTER)**
 Needle Holder GEN-157
- DERLACKI**
 Mobilizer ENT-80
 Ossicle Holding Clamp ENT-7
- D'ERRICO**
 Bayonet Forceps CVT-104, GEN-32, GEN-89,
 NEU-29
 Bayonet Tissue Forceps NEU-38
 Hypophyseal Forceps GEN-90
 Lamina Chisel SPN-3
 Nerve Root Retractor .. GEN-221, GEN-237, RET-133,
 SPN-130
 Perforator Drill & Enlarging Burr NEU-20
 Pituitary Forceps NEU-36
- DESJARDINS**
 Gall Stone Forceps GEN-50
 Gall Stone Scoop GEN-309
- DESMARRES**
 Chalazion Forceps OPH-15
 Lid Retractor OPH-46, RET-86
- DIETHRICH**
 Aorta Clamp CVT-10
 Bulldog Clamps CVT-20-21
 Coronary Artery Scissors CVT-190, GEN-254
 Instrument Case CVT-56
 Magic Cut Ceramic Vascular Scissors CVT-210-211

- Needle Holders..... CVT-128, GEN-156, GEN-157,
GEN-179
- "Razor Edge" Scissors..... CVT-214, CVT-215
- Scissors..... CVT-209-210, GEN-304
- Valve Scissors..... CVT-207, OBE-72
- Vascular Ceramic Coated Scissors..... GEN-304
- DIETHRICH-POTTS**
- Scissors..... CVT-204, CVT-209
- DIETRICH**
- Instrument Case..... SS-37
- DILATORS**
- Case..... CVT-56
- Common Bile Duct..... GEN-19
- Myocardial..... CVT-64
- Ophthalmologic..... OPH-10
- Tracheal..... ENT-18-19, GEN-20, PED-6-7
- Uterine..... OBGYN-9-12
- Vascular..... CVT-64-68, GEN-20, PED-7
- DINGMAN**
- Elevator..... ENT-27
- Mouth Gag..... ENT-82
- Otoabrader Rasp..... ENT-102
- Periosteal Elevator..... ENT-24
- DISSECTORS**
- Ball..... NEU-11
- Bullet Nose..... ENG-35
- Cherry..... NEU-11
- Curved..... LAP-17
- Disc..... NEU-11
- Dolphin Nose..... ENG-34
- Facial..... ENT-19
- Flat..... LAP-16
- General Purpose... CVT-68-70, GEN-21, NEU-12-13,
NEU-15-17, O/A-16, O/A-19, OBE-19-20, OBE-36,
SPN-38-42
- Laparoscopic..... LAP-6-7, LAP-13, LAP-16-17,
LAP-19-20, LAP-32
- Micro..... NEU-13, NEU-15-16, NEU-136
- Needle Nose..... ENG-36
- Neurovascular..... NEU-14
- Peanut..... NEU-14
- with Retractor..... ENT-112
- Right Angle..... ENG-38-39
- Secto®..... NEU-11-12, NEU-14-15
- Soft Curve..... ENG-39
- Teardrop..... NEU-14
- Tonsil..... RET-148
- Transsphenoidal..... NEU-15
- Triangle..... NEU-15
- Vertebral..... SPN-39
- DISTRACTORS**
- Cervical..... SPN-42
- Pin..... SPN-42
- DIX**
- Needle & Gouge..... OPH-40
- DOANE**
- Knee Retractor..... O/A-90, RET-96
- DODD**
- Knot Pusher..... LAP-24
- DODICK**
- Nucleus Splitter..... OPH-15
- DORSEY**
- Dural Separator..... GEN-23, NEU-121
- Fenestrated Grasper..... LAP-8
- Grasping Forceps..... LAP-63, LAP-70
- DOWEL INSTRUMENTS**
- Crossbar Handle..... SPN-44
- Dowel Cutter..... SPN-43
- Dowel Cutter Shaft..... SPN-44
- Dowel Ejector..... SPN-44
- Dowel Pin..... SPN-45
- DOYEN**
- Abdominal Scissors..... CVT-193, GEN-252
- Intestinal Forceps..... GEN-62, GEN-63
- Rib Raspatory..... CVT-137, PED-22
- Scissors..... OBE-72
- Vascular Intestinal Clamp..... CVT-33, GEN-9
- DREWS**
- Cillia Forceps..... OPH-15
- DRILLS** **NEU-19**
- ACR..... SPN-45
- Burr Holder (Wire Mesh)..... CVT-62
- Burr Set..... NEU-17
- Burrs..... NEU-17, NEU-19, NEU-20
- Cerebellar..... NEU-18
- Cervical..... SPN-45
- Cervical Tip..... NEU-18
- Cranial..... NEU-18
- Crossbar Handle..... NEU-18
- Guard Cap..... NEU-19, SPN-45
- Guide & Dura Protector..... NEU-19
- Hand-Operated..... NEU-20
- Perforator..... NEU-20-21
- Shaft..... NEU-21, SPN-45
- Twist..... SPN-44-45
- DRIVERS**
- Anterior Cervical..... SPN-47
- Calcar..... O/A-17
- Flexible..... O/A-17
- Hand-Operated..... O/A-17
- Hex..... O/A-17-18
- Lumbar..... SPN-47
- Screw Driver..... SPN-47
- Universal Handle..... O/A-18
- DRYSDALE**
- Nucleus Manipulator..... OPH-37
- DUFFIELD**
- Vascular Scissors..... CVT-210
- DUNCAN**
- Biopsy..... OBGYN-5
- DUNNING**
- Elevator & Curette..... ENT-12
- DURAL SEPARATORS**
- See also ELEVATORS
- DUVAL**
- Grasping Forceps..... LAP-48, LAP-70

Lung Forceps..... CVT-91, GEN-89, LAP-39, OBE-28
Tissue Forceps.....CVT-104, GEN-91, OBE-28

DUVAL-COLLINS

Tissue Grasping ForcepsGEN-91

E**EASTMAN**

Vaginal RetractorOBGYN-40, RET-154

ECHLIN

Duckbill RongeurSPN-137
Laminectomy Rongeur NEU-106, SPN-176
Rongeurs.....O/A-97, O/A-104

EDNA

Classic® Towel Clamp GEN-12

ELECTRODES

See also ENERGY

LaparoscopicENG-51
MonopolarENG-31-34, LAP-92
Monopolar BladeENG-50
Monopolar LoopENG-52
Monopolar NeedleENG-53-57

ELECTROSURGICAL CORDSENG-58-59

ELECTROSURGICAL PENCILSENG-62-63

ELEVATORS

Angled NEU-21
Ball EndENT-21
Canal.....ENT-20
with Chisel.....ENT-22
Cleft Palate.....ENT-20-21
with Curette.....ENT-12
DuckbillENT-23, NEU-21
General Purpose.. CVT-70, GEN-21-26, NEU-21-22,
NEU-26-27, O/A-19, OBE-20-22, SPN-48-58
Mastoid Hook & SearcherENT-20
Metatarsal..... O/A-19-20
Middle EarENT-20-24
NasalENT-24
Nerve RootSPN-55
Osteophyte.....O/A-21
Periosteal CVT-70, ENT-24-25, GEN-22-26, PED-8,
NEU-22-25, O/A-16, O/A-19, O/A-21-28, SPN-48,
SPN-51-53, SPN-55-57
SeptalENT-25-26
Skin.....ENT-24-26
Spinal.....SPN-49-50
Staphyloorrhaphy..... GEN-23, GEN-26, NEU-26
ZygomaENT-27-29

ELLIOT

Obstetrical Forceps.....OBGYN-21

ELLIS

Foreign Body Spud OPH-73

ELSCHNIG

Fixation Forceps.....OPH-16

EMMETT

Tenaculum Hook..... OBGYN-28, OBGYN-53
Uterine SoundOBGYN-45

ENDOPAK

SS-18

ENDOSCOPES

ArthroscopicO/A-29

ENERGY

See also ELECTRODES

Anesthesia Circuit Shield..... ENG-64, ENT-31
Bayonet Monopolar Forceps.....ENG-26-28, ENT-34
Bipolar Cords.....ENG-58, ENT-30
Electrosurgical CordsENG-58-59
Electrosurgical PencilsENG-62-63
Energy AccessoriesENT-30-33
Holster Electrosurgical Accessory .ENG-64, ENT-32
Monopolar Adapters, ElectrodeENG-61, ENT-33
Monopolar Cords . ENG-58-59, ENT-30-31, LAP-93
Monopolar ElectrodesENG-31-34, LAP-92
Reusable Bipolar Forceps... ENG-12-25, ENT-34-38
Single-Use Bipolar Forceps .. ENG-3-11, ENT-39-42

ENUCLEATORS

Bayonet NEU-28
General PurposeNEU-135
Micro NEU-28
TranssphenoidalNEU-27-28

EPPENDORFER

Cervical Biopsy ForcepsOBGYN-14

EPSTEIN

Curette.....NEU-8, SPN-35

ERHARDT

Forceps..... OPH-16, PED-14, PED-45

ERICH

Arch Bar.....ENT-3

ESMARCH

Bandage Scissors.....GEN-255

EUPHRATE-PASQUE

Needle Holder GEN-158

EVANS

Tissue Forceps.....GEN-91

EWALD-HUDSON

Dressing ForcepsCVT-80, GEN-46
Forceps..... PED-10, PED-47
Tissue Forceps.....CVT-104, GEN-92

EXCAVATORS

Middle EarENT-43
with Probe..... GEN-175-176

EXODONTIA

Oral Double-Ended Curette..... ENT-11
ElevatorENT-27

EXTRACTORS

Acetabular ComponentO/A-29
Acetabular ProsthesisO/A-29
ComedoneGEN-26
Femoral Prosthesis O/A-29-30
Fetal Head.....OBGYN-13

IUD OBGYN-13
 Prosthesis O/A-30-31

F

FAHLBUSCH

Pituitary Curette NEU-9
 Pituitary Scoop NEU-121

FANSLER

Operating Speculum REC-7

FARABEUF

Pediatric Retractor GEN-222, RET-43

FARR

Spring Retractor GEN-249, O/A-92, RET-65

FARRELL

Cotton Applicator GEN-2

FARRIOR

Speculum ENT-141-143

FAULKNER

Antrum Curette ENT-18

FAVALORO

Coronary Scissors CVT-190

FAVALORO-MORSE

Sternal Retractor CVT-176, RET-145

FAVALORO-SEMB

Ligature Carrier CVT-34

FEILCHENFELD

Splinter Forceps GEN-68

FERGUSON

Clamp GEN-3
 Rectal Retractor RET-100

FERGUSON-FRAZIER

Suction Tube GEN-317

FERGUSON

Abdominal Scissors CVT-194, GEN-252
 Gall Stone Scoop GEN-309

FERRIERA

Retractor RET-40

FERRIS-SMITH

Intervertebral Disc Rongeur ... NEU-95-96, SPN-147
 Rongeur OBE-70
 Sponge Forceps ENT-62
 Tissue Forceps CVT-104, GEN-92, NEU-39

FERRIS-SMITH KERRISON

Rongeur NEU-95, SPN-159, SPN-176

FERRIS-SMITH SPURLING

Intervertebral Disc Rongeur NEU-96

FILES

Bone O/A-31-32, SPN-58

FINE-THORNTON

Swivel Ring OPH-48

FINOCHIETTO

Rib Retractors CVT-168, CVT-169, RET-104
 Rib Spreader CVT-219

FISHER

Tonsil Knife ENT-79

FLASHPAK®

Refurbish Kit O/A-50

FLETCHER (JAVERTS)

Sponge Forceps GEN-71

FLIERINGA

Fixation Ring OPH-48

FLYNN

Scleral Depressor OPH-9

FOERSTER

Sponge Forceps GEN-71, GEN-72

FOERSTER (BALLENGER)

Sponge Forceps GEN-72

FOMON

Dorsal Scissors ENT-126
 Guarded Osteotome ENT-89
 Hook Retractor ENT-110, RET-49
 Lower Lateral Scissors ENT-128
 Micro-Serrated Scissors GEN-260
 Nasal Rasp ENT-101
 Nasal Scissors ENT-130
 Rasp ENT-103

FOOT PLATE HOOKS

Middle Ear ENT-43

FORCEPS

See also CLAMPS; GRASPERS; RONGEURS; TISSUE
 FORCEPS

ACF SPN-58
 Alligator CVT-71, ENT-44, ENT-49, ENT-54-55,
 GEN-34, LAP-6, LAP-62, NEU-28, NEU-35, PED-8
 Allis LAP-4-5
 Antrum Punch ENT-61
 Artery CVT-71-75, GEN-26-30
 Artery & Intestinal GEN-31
 Arthroscopic O/A-33
 Atraumatic ... LAP-35-36, LAP-44, LAP-53, LAP-61,
 LAP-68
 Bariatric CVT-76, CVT-96, CVT-110-111, GEN-71,
 GEN-82-83, OBGYN-28
 Bayonet
 CVT-78, CVT-80-82, CVT-101, CVT-104, CVT-108,
 ENG-3-7, ENG-12-21, ENG-27-28, ENG-60, ENT-
 34, ENT-48, GEN-31-34, GEN-36-40, GEN-43-44,
 GEN-46-48, GEN-89, GEN-94, NEU-29, NEU-33,
 NEU-35, NEU-38, NEU-40
 Biopsy ENG-49, ENT-44-45, LAP-8, LAP-16,
 LAP-45, LAP-48, LAP-76, OBGYN-13-14
 Bipolar ENG-3-11, ENG-12-25, GEN-34-41, LAP-90
 Biting ENT-45
 Bone Cutting. NEU-29-30, O/A-33-35, OBE-23-24,
 SPN-59-60

- Bone Holding O/A-35-37
 Bone Reduction O/A-37-38
 Bone Reposition O/A-39
 Bone Rongeur SPN-60
 Bottle Nose. See Dolphin Nose
 Bowel Grasping LAP-57, LAP-64, LAP-69, LAP-71
 Brain Tumor GEN-86, NEU-30
 Bronchus Clamp GEN-41
 Bullet Nose ENG-47
 Capsule OPH-17
 Capsule Tag OPH-20
 Capsulorhexis OPH-21, OPH-24-25, OPH-26
 Cartilage & Meniscus GEN-86
 Catheter GEN-41
 Caval Occlusion CVT-77
 Cervical GEN-84, OBGYN-14
 Chalazion OPH-11, OPH-15-16, OPH-18, OPH-20
 Cholangiogram LAP-46
 Cilia OPH-11, OPH-15
 Clamp Applying CVT-15
 Claw LAP-8, LAP-15, LAP-20, LAP-46, LAP-55,
 LAP-63, LAP-77, LAP-84
 Clip Applier CVT-54
 Clip Applying NEU-41
 Coaptation ENG-8, ENG-22, GEN-35
 Coarctation CVT-76
 Cobra LAP-11, LAP-43, LAP-51, LAP-60, LAP-63,
 LAP-81, LAP-88
 Conjunctival Fixation OPH-24
 Corneal OPH-21, OPH-25-26
 Corneo-Scleral OPH-17
 Coronary CVT-77
 Crimper ENT-46, ENT-54-55
 Cup ... ENT-51-52, ENT-54, ENT-59, LAP-10, LAP-15,
 LAP-47, NEU-31, NEU-35
 Cup Tooth ENG-43, ENG-48, LAP-55, LAP-78,
 LAP-84
 Cutting ENT-45-46
 Cystic Duct GEN-42
 with DeBakey Teeth LAP-34, LAP-36, LAP-53
 Deep OBGYN-15
 Deep Surgical CVT-77-78
 Delicate PED-9
 Dissecting CVT-78, ENG-44-48,
 GEN-42, LAP-6-7, LAP-10, LAP-14-15, LAP-37-39,
 LAP-46-47, LAP-49-50, LAP-54-56, LAP-58-59,
 LAP-65, LAP-68-72, LAP-78-81, LAP-84-87
 Dissecting and Ligature GEN-42
 Dissecting Artery CVT-78, GEN-43
 Dolphin Nose ENG-43, ENG-44-45,
 ENG-47, LAP-7, LAP-10, LAP-14, LAP-46, LAP-54,
 LAP-68, LAP-77, LAP-83
 Double-Spoon ENT-46-47
 Dressing CVT-78-82, ENT-47-48, GEN-114-115,
 GEN-43-49, NEU-31-32, NEU-40, NEU-135,
 OBE-23-26, PED-9-10, PED-45, SPN-60-61
 Dual Purpose PED-8
 Duckbill ENG-45, ENG-48, LAP-39, LAP-47,
 LAP-70, LAP-78, LAP-85
 Dura NEU-33
 Ear ENT-47-49, GEN-32, PED-10
 Endo LAP-9
 Exposed Top ENG-60
 Eye Dressing GEN-46, PED-11
 Fenestrated ENG-45, ENG-48 LAP-6, LAP-10,
 LAP-17, LAP-35, LAP-78-79, LAP-85
 Fixation ... OPH-14, OPH-16-17, OPH-20-21, PED-45
 Foot-Activated ENG-28, ENG-30
 Foreign Body OPH-23
 Frontal Sinus ENT-50
 Fundus Trimax LAP-48, LAP-79
 Gall Stone GEN-50
 Gallbladder CVT-83, GEN-50, GEN-97
 Gastrointestinal GEN-51
 General Purpose CVT-93, CVT-94, CVT-114-120,
 NEU-41-43, OBE-23
 Giraffe ENT-47, ENT-61
 Goiter GEN-51
 Grasping CVT-84, CVT-91,
 ENG-45, ENG-48, ENT-52-53, GEN-84, GEN-91,
 LAP-6, LAP-9-10, LAP-13, LAP-15, LAP-34-37,
 LAP-40-45, LAP-47-48, LAP-50-53, LAP-55-57,
 LAP-59-71, LAP-73-76, LAP-79, LAP-81-85,
 LAP-87-90
 Grasping & Extracting LAP-41
 Hemostatic CVT-84-89, CVT-93, CVT-99, CVT-115,
 CVT-119, GEN-52-60, GEN-102, GEN-123, NEU-37,
 PED-11-13, PED-15
 Hypophyseal GEN-31, NEU-33
 Hysterectomy GEN-7-8, GEN-61, GEN-82,
 OBE-28, OBGYN-15-20
 I.M.A. CVT-90
 Intestinal CVT-90, GEN-56, GEN-62, GEN-108,
 OBE-24, OBE 28
 Iris GEN-63, OPH-13, OPH-17-18, PED-45
 Irrigating ENG-7, ENG-14, ENG-17-18, ENG-20,
 ENG-21
 Jewelers ENG-10, ENG-23-25,
 ENG-29, GEN-35-36, GEN-63, GEN-97, NEU-42,
 OPH-19, PED-47
 Kidney Stone GEN-64, URO-5
 Laparoscopic ENG-35-49, LAP-4-18, LAP-20,
 LAP-34-89, LAP-75-90, OBGYN-28
 Laryngeal ENT-50-52
 Lens OPH-11-12, OPH-20
 Lens Holding OPH-11, OPH-20
 Lid OPH-16
 Ligament SPN-61
 Ligamentum Flavum O/A-39, SPN-61
 Ligature GEN-64
 Ligature Carrying CVT-90, OBE-28
 Lung CVT-91, LAP-39
 Lung and Tissue OBE-28
 Lung Grasping GEN-64
 MagnaFree® PED-13
 Malleolar O/A-39
 Maxillary ENT-51
 Meniscus O/A-40
 Micro .. CVT-91-93, CVT-109, CVT-118, ENG-48-50,
 ENT-52, GEN-28, GEN-64-67, GEN-73, GEN-100,
 LAP-10, LAP-15, NEU-33-36, OBGYN-20, PED-14,
 PED-45
 Micro Artery GEN-65
 Micro Bayonet GEN-65
 Micro Cup PED-14
 Micro Fenestrated LAP-49, LAP-59
 Microlumbar SPN-61
 Middle Ear ENT-53-55

- Miniature ENT-53, ENT-54
 Monopolar ENG-26-30, ENG-35-39
 Mosquito CVT-86, CVT-93, GEN-28, GEN-56,
 GEN-66-68, PED-12, PED-15
 Mosquito Artery GEN-68
 Muscle OPH-19
 Muscle Biopsy GEN-5
 Nasal ENT-56-58, ENT-61-62
 Nasal Dressing ENT-56, ENT-58
 Nasal Polyp ENT-59
 Nasal Punch ENT-59
 Needle GEN-102, GEN-108
 with Needle Holder CVT-127, GEN-42
 Needle Nose LAP-59, LAP-65
 Needle Pulling CVT-103, GEN-120
 Neurovascular NEU-36
 Obstetrical OBGYN-20-22
 Odontoid Peg SPN-62
 Ophthalmologic OPH-11-27
 Oval Cup ENT-59
 Ovum OBGYN-22
 Pediatric PED-8-16, PED-45-49
 Pelvic O/A-40
 Phalangeal O/A-40
 Pile Clamp GEN-68
 Pituitary NEU-35, NEU-36
 Placenta GEN-55, OBGYN-22
 Placenta and Ovum OBGYN-23
 Plaque Removing CVT-94-95
 Polyp ENT-47
 Post Nasal ENT-59
 Ptosis OPH-12
 Rectal Biopsy REC-2
 "Resano-Type" CVT-119
 Retention Grasping LAP-34, LAP-42, LAP-87
 Retraction Grasping ... LAP-59-60, LAP-66, LAP-73,
 LAP-88
 Retrograde Grasping LAP-13, LAP-50
 Reusable Bipolar ENT-34-38
 Right Angle CVT-95
 Ring Tip CVT-96, CVT-107
 Scalp GEN-105, NEU-36-37, PED-15
 Scoop LAP-16
 Screw Removal O/A-41
 Seismoidectomy O/A-41

 Seizing GEN-107
 Septum ENT-60-61
 Side Cutting SPN-193
 Single-Use ENG-3-11, ENG-26
 Single-Use Bipolar ENT-39-42
 Sinus ENT-61-62
 Skin Hook GEN-68
 Sleeve Spreading OPH-25
 Slide Lock LAP-60
 Snake Tooth. See Cobra
 Splinter GEN-68-70
 Sponge CVT-96-97, CVT-118, ENT-62, GEN-70-72,
 GEN-116, OBE-29
 Spoon LAP-18, LAP-20, LAP-61, LAP-89, NEU-37
 Spring Clip CVT-54
 Stapedectomy ENT-55
 Stay Suture Clamp CVT-97

 Stomach Resection Clamps GEN-73
 Stone Retrieval LAP-43, LAP-51, LAP-60-61,
 LAP-66, LAP-82, LAP-88-89
 Suture GEN-73-74, OPH-13-14, OPH-19, OPH-23
 Suture Stay GEN-74-75
 Suture Tag CVT-97, PED-16
 Suture Tying OPH-24
 Synovectomy O/A-41
 Synovectomy, with Rongeur SPN-142
 Tenaculum OBGYN-53-54
 Tenaculum Grasping LAP-52, LAP-74, LAP-89
 Tendon GEN-75, NEU-38, O/A-42
 Thoracic ... CVT-98-99, GEN-76, GEN-109, OBE-29
 Thoracic Dissecting CVT-46
 Thoracoscopy CVT-78, CVT-84
 Thumb CVT-110-111, GEN-83
 Tissue CVT-99-111, GEN-77-114,
 LAP-9, LAP-17, NEU-38-40, OBE-23, OBE-30-34,
 OPH-12, PED-16, PED-45, PED-47-49
 Tissue-Tying GEN-114
 Titanium ENG-18-19, ENG-25, GEN-114-116,
 OPH-14-15, OPH-24-26
 Tongue GEN-116
 Tonsil ENG-7, ENT-41, ENT-62-63, GEN-116
 Tooth Cup LAP-52, LAP-69
 Tracheal Tenaculum GEN-117
 Transsphenoidal NEU-40
 Tube Holding CVT-112
 Tube Occluding GEN-15
 Tumor GEN-106, NEU-40
 Tunneling CVT-226
 Turbinate ENT-63
 Tying GEN-117, NEU-41, OPH-11, OPH-15,
 OPH-18-20, OPH-22-25
 Uterine GEN-117-118, OBGYN-23-25
 Utility NEU-41, OPH-13, OPH-18, OPH-21-22,
 OPH-26
 Vascular CVT-112-114, GEN-120, OBE-34, PED-16
 Vascular Tissue GEN-114
 Vasectomy GEN-123
 Vessel CVT-114
 Vulsellum OBGYN-26-27
 Watchmaker NEU-41

FOSS
 Gall Bladder Retractor GEN-214, RET-41

FOX
 Dermal Curette GEN-18
 Eye Shield OPH-67
 Sphere Introducer OPH-34
 Tissue and Gum Scissors ENT-135, GEN-302

FRANCIS
 Chalazion Forceps OPH-16
 Spud OPH-73

FRAZIER
 Dural Hook NEU-45, PED-17
 Dural Scissors GEN-281, NEU-114
 Dural Separator GEN-23, NEU-121
 Skin Hook GEN-127
 Suction Tube GEN-317-319, NEU-132, PED-44

FREEMAN
 Retractors RET-49, RET-75

FREEMAN-GORNEY

Razor Scissors..... GEN-280

FREER

Chisel..... ENT-6
 Double Hook..... ENT-64, GEN-124
 Elevator ENT-24, GEN-24, O/A-24
 Periosteal Elevator..... CVT-70
 Septum Knife..... ENT-78

FRIEDMAN

Bone Rongeur..... ENT-118, NEU-85, O/A-97
 Micro Rongeur..... NEU-108, O/A-97
 Rongeur SPN-137

FUKUDA

Shoulder Retractor O/A-80, RET-97

FUKUSHIMA

Tapered Teardrop Suction Tube..... GEN-320-321,
 NEU-130
 Suction Tubes SPN-188

FULTON

Laminectomy Rongeur . NEU-106, OBE-68, SPN-137
 Rongeur O/A-98

G**GALAND**

Lens Manipulating Hook..... OPH-29

GALT

Trepine..... NEU-137, SPN-192

GARDNER-WELLS

Traction Tongs NEU-122

GARRETT

Dilator..... CVT-64-65
 Multi Purpose Peripheral Vascular Retractor
 CVT-167
 Vascular Dilator CVT-66-67, GEN-20, PED-7
 Vascular Dissector OBE-20
 Vascular Retractor RET-157

GARRIGUE

Vaginal Speculum OBGYN-47

GASS

Retinal Detachment Hook..... OPH-29

GASTRIC BAND PASSER LAP-24

GAUGES

ACR..... SPN-62
 Cervical Spanner SPN-62
 Depth..... SPN-62-63
 Ophthalmologic OPH-27
 Spinal..... SPN-63

GAYLOR

Uterine Biopsy Forceps OBGYN-23

GELPI

Bookwalter® Blades CVT-143, GEN-186, RET-9
 Perineal Retractor GEN-244, OBGYN-39, RET-62,

RET-63
 Retractor CVT-143, GEN-186, GEN-244, OBE-47

GEMINI

Classic® Clamp..... PED-3
 Classic® Delicate Clamp..... CVT-28, GEN-6, GEN-92
 Dissecting Forceps..... LAP-39
 Forceps..... CVT-30, OBE-26, OBE-32
 Hemostatic Clamp .CVT-31, GEN-7, GEN-54, OBE-4
 Right Angle Forceps CVT-95
 Tissue Forceps..... CVT-105, GEN-93

GEMINI MIXTER

Forceps..... CVT-93, GEN-93

GERALD

Bayonet Forceps..... CVT-81, ENG-14, GEN-38,
 GEN-46, GEN-94
 Bipolar Forceps ..ENG-9, ENG-14, ENG-22, ENT-36,
 GEN-35, GEN-38
 Dressing Forceps GEN-47, NEU-32
 Ring Tip Titanium Forceps..... CVT-96
 Single-Use Bipolar Forceps ENT-42
 Tissue Forceps CVT-105-107, GEN-93, GEN-94-95,
 NEU-39, OBE-32

GERALD-DEBAKEY

Ring Tip Forceps CVT-107
 Tissue Forceps..... CVT-107

GERZOG

Mallet O/A-57

GIERTZ

Rib Shears CVT-217

GIGLI

Saw Handle..... NEU-110-111
 Twisted Wire Saw NEU-112

GIGLI (OLIVECRONA)

Wire Saw..... NEU-112

GILLES

Skin Hook GEN-128, GEN-130, NEU-52

GILLIES

Forceps..... CVT-116, GEN-47
 Needle Holder & Scissor Holder..... GEN-138
 Tissue Forceps..... GEN-95
 Zygoma Elevator ENT-27

GILLS

Iris Forceps..... OPH-17

GILLS-VANNAS

Capsulotomy Scissors OPH-53

GILLS-WELSH

Lens Loop OPH-36
 Cannulas OPH-4
 Capsule Forceps OPH-17

GIL-VERNET

Renal Retractor..... GEN-238, URO-5

GIMBEL

Irrigating Cannula..... OPH-4

GIRARD

Forceps..... OPH-17

B.E. GLASS

Abdominal Retractor GEN-183, RET-43

GLASSMAN

Forceps LAP-5, LAP-19
 Gastrointestinal Clamp OBE-5
 Gastrointestinal Forceps GEN-51
 Grasping Forceps LAP-40
 Non-Crushing Gastrointestinal Clamp GEN-6
 Stomach Resection Forceps GEN-72

GLENNER

Hysterectomy Forceps OBGYN-15

GLOVER

Bulldog Clamps CVT-19, CVT-21
 Clamp CVT-53
 Classic® Auricle Appendage Clamp CVT-17
 Classic® Spoon-Shaped Clamp CVT-43
 Coarctation Clamps CVT-26, CVT-27, OBE-4
 Ductus Clamp CVT-29

GLUCK

Rib Shears CVT-216

GOELET

Retractor CVT-180, GEN-223, RET-50

GOLDMAN

Nasal Scissors ENT-130
 Septum Elevator ENT-26
 Septum Scissors ENT-132

GOLDMAN-KAZANJIAN

Rongeur ENT-121

GOLDSTEIN

Neck Retractor RET-119

GONIOMETERS

Finger GEN-123

GOOD

Antrum Rasp ENT-102

GOODHILL

Alligator Forceps ENT-44

GOODYEAR

Uvula Retractor ENT-117, RET-150

GORDON

Vulsellum Forceps OBGYN-26

GORNEY

Ceramic Coated Scissors GEN-260
 Rake Spring Neck Retractor RET-50
 Septum Suction Tube ENT-147
 Turbinate Scissors ENT-136

GORNEY ADSON

Forceps GEN-95

GOUGES**OPH-40, SPN-63-66**

Acetabular O/A-42
 Arthroscopic O/A-42
 Bone O/A-42, OBE-34
 Swan Neck SPN-66

GRADLE

Stitch Scissors GEN-294

GRAEFE

Forceps OPH-17-18

GRAETHER

Collar Button OPH-46
 Retractor RET-85

GRAFTING

Suction Tube GEN-321

GRAHAM

Hook NEU-52

GRANT

Abdominal Aortic Aneurysm Clamp CVT-4

GRASPERS*See also* FORCEPS

Alligator ENG-37
 Arthroscopic O/A-46
 Atraumatic ENG-38, LAP-11-12
 Bowel ENG-42, LAP-17
 Circular Anvil LAP-24
 Claw ENG-34
 Cobra Tooth ENG-40
 Cup Tooth ENG-36
 Dolphin Nose ENG-35
 Fenestrated LAP-8, LAP-12, LAP-17
 Fundus Tri-Max ENG-37
 General Purpose ENG-40
 Laparoscopic ... LAP-2-3, LAP-5, LAP-8, LAP-11-14,
 LAP-17-19
 Micro Fenestrated ENG-36
 RapidClean® LAP-2-3
 Retraction ENG-38
 Spike Tooth LAP-81
 Traumatic LAP-2-3, LAP-5, LAP-14
 Wave ENG-37

GRAVES

Vaginal Speculums ENG-64, OBGYN-47-50

GREEN

Retractor GEN-223
 Suction Tube Holder CVT-224
 Thyroid Retractor ENT-116, RET-147
 Uterine Curette OBGYN-7

GREENBERG®

Floating Secondary Bar NEU-71
 Hand Rest NEU-71
 Instrument Holders NEU-72
 Long Arm NEU-73
 Maxi-Vise Adaptor NEU-73
 Pattie Tray NEU-73-74
 Primary Bar NEU-74
 Retractor Blade NEU-74
 Retractors RET-79-84
 Secondary Bar NEU-75
 Short Coupler NEU-75
 Short Retractor Arm NEU-75
 Sterilizing Case NEU-76
 Universal Retractor & Handrest Kit NEU-70-71
 Universal Retractor Case SS-38

GREENE

Thyroid Retractor GEN-223

GREGORY

Bulldog Clamps..... CVT-19, CVT-21, CVT-22
 Miniature Vascular Clamp CVT-35
 Profunda Clamp CVT-41
 Stay Suture Clamp..... CVT-44, CVT-97, PED-5
 Suture Stay Forceps GEN-75

GROSS

Ear Spoon & Hook ENT-12

GRUBER

Speculum..... ENT-143-144

GRUENWALD

Bayonet Forceps..... GEN-32, GEN-47
 Nasal Punch Forceps..... ENT-59

GUIDES

CatheterURO-3

GUILFORD-WRIGHT

Drum Elevator ENT-22
 Elevator Knife ENT-74
 Loop Spreader ENT-145
 Micro Curette ENT-14
 Suction Tube..... GEN-321

GUTHRIE

Eye Fixation Hook GEN-130, PED-17
 Fixation Hook Del GEN-130
 Skin Hook GEN-128

GUYON

Catheter Guide.....URO-3

GUYON-MAYO

Vessel Clamp GEN-17

GUYON-PARK

Speculum..... OPH-70, RET-86

H**HAGEMANN-DIETRICH**

Vascular Scissors..... CVT-210

HAIGHT

Pediatric Rib Spreader..... CVT-218

HAIGHT-FINOCHIETTO

Rib Retractor CVT-169, RET-104
 Rib Spreader CVT-219

HAJEK

Bone Mallet..... O/A-58

HAJEK BALLENGER

Elevator ENT-28

HAJEK-KOFLER

Punch..... ENT-99

HALLE

Nasal Speculum..... ENT-139, RET-40

HALLE HOUGH

Curette..... ENT-15

HALLMAN

Tunneling Forceps CVT-226

HALSEY

Needle Holder CVT-129, GEN-158-159

HALSTED

Forceps PED-11, PED-15
 Hemostatic Forceps..... CVT-87, GEN-54
 Mosquito Forceps..... CVT-86-87, GEN-66-68

HAMMERS

See also MALLETS GEN-124

HANDLES

See also KNIFE HANDLES

Impaction O/A-46
 Quick-Coupling..... O/A-46
 RapidClean® LAP-75
 Ratcheting O/A-47
 for Reposable Scissors LAP-25
 Saw NEU-110-111

HANK

Uterine Dilator OBGYN-9-10

HARDY™

Bay Curette SPN-35-36
 Bayonet Bipolar Forceps ENG-15, GEN-38
 Bayonet Curette..... OBE-13
 Curette..... NEU-10, NEU-134
 Dressing Forceps CVT-81, GEN-47, NEU-40,
 NEU-135
 Enucleator NEU-27-28, NEU-135
 Instrument Case SS-38
 Knife Handle..... NEU-53, NEU-136, SPN-84
 Lip Retractor NEU-83, NEU-136, RET-87
 Micro Dissector..... NEU-15, NEU-136
 Nasal Bivalve Specula NEU-125, NEU-137
 Pituitary Spoon..... NEU-126, NEU-137
 Stella Punch NEU-63
 Suction Tube..... GEN-322, NEU-131
 Transsphenoidal Bayonet Enucleator NEU-28
 Transsphenoidal Instruments..... NEU-134-137
 Transsphenoidal Mirror NEU-57

HARDY™-DUDDY

Vaginal Speculum OBGYN-50

HARKEN

Auricle Clamp..... CVT-53

HARMS

Utility Forceps..... OPH-18

HARMS-TUBINGEN

Tying Forceps OPH-18

HARRINGTON

Artery Forceps..... CVT-74, GEN-28
 Forceps..... CVT-117
 Retractor Blade (Bookwalter®)..... CVT-141, CVT-157,
 GEN-187, OBE-47, OBE-54, RET-10, RET-28-29,
 RET-143
 Splanchnic Retractor CVT-174, GEN-224, OBE-66
 Thoracic Clamp CVT-99, OBE-7
 Thoracic Clamp Forceps..... GEN-76

- Universal Ring Retractor Blade GEN-204-205
- HARRINGTON-MIXTER**
Clamp OBE-6
Forceps GEN-95
Thoracic Clamp CVT-45
- HARRINGTON-PEMBERTON**
Retractor GEN-223
- HARRIS-SINSKEY**
Lens Manipulating Hook OPH-38
- HARTMANN**
Alligator Forceps ENT-44
Baby Mosquito Artery Forceps GEN-68
Ear Forceps ENT-47-48, PED-10
Micro Mosquito Artery Forceps GEN-28
Nasal Dressing Forceps ENT-58
Speculum ENT-144
- HARTMANN-HALLE**
Nasal Speculum ENT-139
- HARTMANN-HERZFELD**
Forceps ENT-47-48
- HASSON**
"S" Retractor LAP-25, OBE-37, RET-72
- HAYES**
Hand Retractor GEN-224, O/A-89, RET-91
- HEALON**
Injection Cannula OPH-5
- HEANEY**
Classic Plus® Needle Holders CVT-129, GEN-160
Hysterectomy Forceps GEN-61, OBGYN-16-17
Hysterectomy Retractor OBGYN-39, RET-71
Needle Holder CVT-130, GEN-160, OBE-38
Tissue Forceps GEN-96
Uterine Curette OBGYN-7
- HEANEY-KANTER**
Hysterectomy Forceps GEN-61
- HEANEY-REZAK**
Hysterectomy Forceps GEN-61, OBGYN-17
- HEANEY-SIMON**
Vaginal Retractor OBE-67, OBGYN-40, RET-72,
RET-154
- HEATH**
Chalazion Curette OPH-8
Mallet O/A-58, NEU-56, SPN-85
- HEGAR**
Uterine Dilator OBGYN-10-11
- HEISS**
Artery Forceps CVT-71, CVT-74, GEN-28
Retractor ENT-107, GEN-224, O/A-80, RET-65
Right Angle Forceps CVT-95
- HEITMILLER**
Mini Thoracotomy Retractor CVT-166, RET-146
- HENDREN**
Clamp CVT-53
- HENLEY**
Retractor Set CVT-180
- HENLY**
Carotid Retractors CVT-164, CVT-172, RET-36
Classic® Modified Vascular Clamp CVT-35
Retractor Blade RET-62
- HENNIG**
Plaster Spreader O/A-2
- HENROTIN**
Vaginal Speculum OBGYN-50
Vulsellum Forceps OBGYN-26
- HEPARIN**
I.M.A. Cannula CVT-3
Needles CVT-135, GEN-172
- HERRICK**
Kidney Clamp GEN-9, URO-4
- HEUWISER**
Antrum Forceps ENT-62
- HEY GROVES**
Bone Holding Forceps O/A-36
- HIBBS**
Chisel O/A-5, SPN-4
Gouge O/A-44, SPN-65
Mallet O/A-58, SPN-85
Osteotome O/A-64, SPN-87
Retractor GEN-224, RET-50, SPN-98
- HILDYARD**
Post Nasal Forceps ENT-59
- HILL-FERGUSON**
Rectal Retractor REC-6, RET-100
- HIMMELSTEIN**
Sternal Retractor CVT-176, RET-145, SPN-135
- HINKLE-JAMES**
Rectal Speculum REC-8
- HINTERMAN**
Retractor O/A-88, RET-65
- HIRSCHMAN**
Iris Hook OPH-29
Lens Spatula OPH-68
- HIRSCHMANN**
Rectal Speculum REC-8
- HOEN**
Alligator Forceps .. CVT-71, GEN-34, NEU-28, PED-8
Bayonet Dressing Forceps CVT-81, GEN-48
Bayonet Forceps GEN-34, NEU-29
Bayonet Tissue Forceps CVT-108, GEN-96
Dressing Forceps NEU-32
Dural Separator GEN-24, NEU-121
Hemostatic Scalp Forceps NEU-37
Intervertebral Disc Rongeur NEU-96, PED-31,
SPN-148
Nerve Hook OBE-35, NEU-47, SPN-68
Periosteal Elevator GEN-24, NEU-23, O/A-24,
SPN-51

- Scalp Hemostat..... CVT-87
 Scalp Hemostatic Forces..... GEN-96
 Tissue Forceps..... NEU-39
- HOHMANN**
 Mini Retractor..... O/A-91
 Retractors... GEN-225, O/A-80-81, RET-90, RET-96
- HOKE**
 Osteotome..... NEU-61, O/A-64-65, SPN-87-88
- HOLDERS**
 Bone Graft..... SPN-66
- HOLSHER**
 Nerve Root Retractor ... GEN-237, RET-134, SPN-130
 Retractor..... OBE-48
- HOLSTERS** ENG-64, ENT-32
- HOOK**
 Biopsy Forceps..... LAP-48
 Reposable Scissors..... LAP-25
 Scissors LAP-41, LAP-49, LAP-57, LAP-64 LAP-71,
 LAP-86
- HOOKS**
 Adson SPN-67
 Ball NEU-43
 Bariatric..... LAP-22
 Bone..... O/A-47-48, OBE-34, SPN-67
 Cement Removal O/A-48
 Cervical..... OBGYN-27
 Cervical Nerve NEU-43
 Crypt..... REC-2
 Dissecting..... NEU-44, SPN-67
 Double..... ENT-64, OPH-29, OPH-31
 Double Fixation..... ENT-65, OPH-29
 Double Hook GEN-124-125
 Dural ENT-65, GEN-126, NEU-44-45, PED-17,
 SPN-67
 Ear ENT-12, ENT-65
 Exploration & Coagulation NEU-46
 Eye PED-17-18
 Ganglion SPN-68
 General Purpose NEU-52-53, O/A-47, SPN-67
 In-Situ Bypass CVT-121
 Iris ENT-66
 IUD OBGYN-27
 Lens Manipulating..... OPH-28-29, OPH-31-32,
 OPH-37-38
 Middle Ear ENT-66-68
 Muscle OPH-30
 Nasal GEN-125
 Nerve. ENT-65, ENT-68, GEN-126-127, NEU-46-51,
 OBE-35-36, SPN-68-69
 Obstetrics/Gynecology OBGYN-27-8
 Ophthalmologic OPH-27-33, PED-17-18
 Push/Pull OPH-33
 Retractor..... ENT-68
 Retrieving..... OPH-28
 Single ENT-68
 Skin.... ENT-69, GEN-125, GEN-127-129, NEU-51-52,
 PED-18
 Spring NEU-52
 Stapes Hook..... ENT-67
- Strabismus OPH-33
 Tenaculum..... ENT-70, OBGYN-28, RET-45
 Tenotomy..... OPH-33
 Thimble..... ENT-70
 Titanium..... OPH-33
 Tracheal..... ENT-68, ENT-70-71, GEN-126, OBE-35,
 RET-149
 Tracheal Retractor GEN-129-131
 Twist Fixation..... OPH-33
 Varicose Vein..... CVT-121
 "Y" OPH-32
- HORGAN**
 Abdominal Retractor RET-6
 Retractor Blade GEN-180
- HORGAN CENTER**
 Retractor Blade OBE-52
- HORSLEY**
 Bone Cutting Forceps NEU-29, O/A-33, OBE-23,
 SPN-59
 Dural Separator NEU-122
- HOUGH**
 Curette..... ENT-14
 Drum Scraper..... ENT-75
 Foot Plate Pick..... ENT-90
 "Hoe" Elevator..... ENT-23
 "Hoe" Pick ENT-90
 Pick ENT-92
 Stapedectomy Forceps ENT-55
 Stapedectomy Pick..... ENT-91
 "Whirly Bird" Knife ENT-76
- HOUGH-DERLACKI**
 Mobilizer ENT-80
- HOUSE**
 Alligator Crimper Forceps ENT-54
 Bayonet Elevator & Chisel ENT-22
 Cut-Off Adapter..... ENT-7, ENT-146
 Gelfoam Press..... ENT-93
 "Gimmick" Elevator..... ENT-23
 Hand Retractor ENT-110, RET-91
 "Hoe" Excavator ENT-43
 Hook..... ENT-68
 Incudostapedial Joint Knife..... ENT-75
 Lancet Knife..... ENT-75
 Middle Ear Mirror..... ENT-80
 Miniature Forceps..... ENT-53-55
 Myringotomy Knife ENT-76
 Needle..... ENT-84
 Obtuse Pick..... ENT-90
 Oval Cup Forceps ENT-54
 Oval Window Pick..... ENT-90
 Sickle Knife ENT-77
 Strut Calipers ENT-4
 Strut Forceps..... ENT-55
 Strut Pick ENT-91
 Tympanoplasty Knife ENT-76
 Window Pick..... ENT-91
 Wire Strut Guide..... ENT-148
- HOUSE-BARBARA**
 Pick ENT-89

HOUSE-CRABTREE

Dissector Pick "Jimmy"ENT-89

HOUSE-DIETERS

Malleus NipperENT-85

HOUSE-ROSEN

NeedleENT-84

HOUSE-SHEEHY

Knife CuretteENT-15

HOUSE STAPES

CuretteENT-15-16

HOUSE WULLSTEIN

Ebonized Miniature ForcepsENT-53-55

Miniature Ear Cup ForcepsENT-54

HOWARD

Aorta Aneurysm ClampCVT-4, CVT-11

HUANG

Vein HolderCVT-178

HUDSON

Cerebellar ExtensionNEU-18

Cranial DrillNEU-18

Cranial Drill CaseSS-38

Cranial Drill SetNEU-17

ForcepsGEN-96

T-HandleO/A-17

HULKA

Uterine TenaculumOBGYN-55

HULKA-KENWICK

Uterine ForcepsOBGYN-23

HUMBY

Swivel Skin HookENT-69, GEN-129

HUNT

Chalazion ForcepsOPH-18

HUNTER

Bowel Grasping ForcepsLAP-57, LAP-64, LAP-71

Uterine CuretteOBGYN-7

HURD

Tonsil Dissector & Pillar Retractor ..ENT-112, RET-148

HURWITZ

Thoracic TrocarCVT-225

I**IMPACTORS**

Bone GraftO/A-49, SPN-70

Central CanalSPN-70

General PurposeSPN-69, SPN-76

Lateral GutterSPN-71

Lumbar and CervicalSPN-71

ProsthesisO/A-50

INGE

Lamina SpreaderSPN-186

INSERTERS

Middle EarENT-71

INSTRUMENT CASES

CastanedaCVT-33, CVT-56, RET-144, SS-37

CrockardRET-108-109

DilatorsCVT-56

General PurposeCVT-56-33, NEU-135

NoonSS-43

Rhoton®SS-43

SterilizingLAP-94-95, NEU-76, RET-82, SPN-12, SS-43

SymmetrySS-44

INSTRUMENT COVERS

Forceps ProtectorsENT-71

INSTRUMENT HOLDERS (STRINGERS)

CVT-60-62, CVT-220-222, GEN-310-313, SS-45

INSTRUMENT LUBRICANTSS-47**INSTRUMENT RACKS**SS-46-47**INSTRUMENTS**

Anterior Cervical Fusion, CaseCVT-57

INTUBATION SETS

OphthalmologicOPH-34

IOWA UNIVERSITY

Membrane Puncturing ForcepsGEN-97

Periosteal ElevatorGEN-24, NEU-24, O/A-24, SPN-52

IRIS

Bipolar ForcepsENG-9

Ceramic Coated ScissorsGEN-260

Tissue ForcepsGEN-97, PED-16, PED-47

ISRAEL

RetractorGEN-225, O/A-81, RET-50

J**JABALEY**

Micro-Serrated Razor Edge ScissorsGEN-287

JACKSON

Lacrimal Intubation SetOPH-34

Laryngeal ForcepsENT-50-53

Nasal Bone ScissorsENT-130

Rectal Biopsy ForcepsREC-2

RetractorsRET-149, RET-155

Tracheal Hook Tenaculum ForcepsGEN-117

Tracheal RetractorENT-110

Tracheal TenaculumENT-107

Vaginal RetractorOBGYN-41

"Velvet Eye" Aspirating TubeENT-146

JACOBS

Uterine Vulsellum ForcepsGEN-117, OBGYN-26

JACOBSON

Bayonet ForcepsGEN-32

Bulldog ClampCVT-22

- Endarterectomy Spatula..... CVT-218
 Heavy Needle Holder GEN-139
 Micro Forceps..... CVT-93, GEN-65
 Micro Mosquito Forceps..... GEN-67
 Micro Needle Holders... CVT-124-126, GEN-140-142,
 GEN-146-147
 Micro Probe..... NEU-62
 Micro Scissors..... CVT-201, GEN-288
 Micro-Coronary Bulldog Clamp CVT-35
 Needle Holders..... CVT-123, GEN-161
 Scissors CVT-194, NEU-119
 Suture Pusher..... NEU-64
 Titanium Needle Holders GEN-146-147
- JACOBSON-ADSON**
 Micro Forceps..... GEN-65
- JAFFE**
 Lens Spatula OPH-68
 Lid Retractor OPH-47, RET-87
 Stitch Scissors..... OPH-56
 Tying Forceps GEN-117, OPH-19
- JAFFE-CASTROVIEJO**
 Suture Forceps GEN-74, OPH-19
- JAFFE-MALTZMAN**
 Lens Manipulating Hook..... OPH-37
- JAKO**
 Laryngeal Probe ENT-94
 Micro Laryngeal Cup Forceps ENT-52
 Micro Laryngeal Knife..... ENT-73
 Micro Laryngeal Scissors ENT-128
 Suction Tube ENT-147
- JAKO-KLEINSASSER**
 Micro Laryngeal Forceps..... ENT-52
 Micro Laryngeal Scissors ENT-128
- JAMESON**
 Caliper..... OPH-2
 Muscle Forceps..... OPH-19
 Muscle Hook..... OPH-30
 Tenotomy Scissors..... ENT-131
- JAMESON METZENBAUM**
 Tenotomy Scissors..... ENT-134, GEN-261, PED-40
- JAMESON REYNOLDS**
 Scissors ENT-136, ENT-137, GEN-261
- JANETTA**
 Angled Elevator NEU-21
 Angled Knife..... NEU-54
 Dissector..... NEU-15
 Double Forked Probe NEU-62
 Duckbill Elevator NEU-21
 Hook..... NEU-52
 Neck Dissector..... NEU-13
 Posterior Fossa Retractor NEU-77, RET-77
 Probe NEU-63
- JANSEN**
 Bayonet Dressing Forceps CVT-82, GEN-48
 Bone Curette SPN-13
 Bone Rongeur..... ENT-119
 Dressing Forceps NEU-32
 Mastoid Retractor..... GEN-244
 Rongeur ENT-121
 Scalp Retractor..... ENT-112, GEN-239, GEN-245,
 NEU-82, RET-107
- JANSEN-MIDDLETON**
 Septum Forceps..... ENT-60
- JARCHO**
 Self-Retaining Uterine Cannula..... OBGYN-29
- JAVID**
 Carotid Artery Clamp..... CVT-24
- JENNINGS**
 Mouth Gag..... ENT-82
- JENSON**
 Capsule Polisher OPH-5
- JOHNS HOPKINS**
 Bulldog Clamp..... CVT-22
 Gallbladder Forceps..... GEN-97
- JOHNSON**
 Spatula..... OPH-68
- JONES**
 Adenoid Curette ENT-9
 I.M.A. Classic Plus® Needle Holder GEN-161
 I.M.A. Forceps..... CVT-90
 Thoracic Clamp CVT-46, GEN-12, OBE-7
 Towel Clamp GEN-13
- JORDAN**
 Canal Elevator ENT-20
 Canal Knife..... ENT-72
- JORGENSON**
 Dissecting Scissors CVT-194, GEN-262
- JOSEPH**
 Bayonet Saw ENT-123
 Button End Knife..... ENT-72
 Nasal Double-Prong Hook..... GEN-125
 Nasal Knife..... ENT-77
 Periosteal Raspatory GEN-177
 Rasp ENT-104
 Razor Edge Scissors..... GEN-262, GEN-280
 Rhinoplasty Scissors ENT-132
 Scissors ENT-131, ENT-137
 Scissors with Micro Serrations..... ENT-133
 Serrated Scissors..... GEN-262
 Single Prong Nasal Hook..... GEN-131
 Skin Hook ENT-69, GEN-125, GEN-128
 Periosteal Elevator O/A-24, SPN-52
- JUDD-ALLIS**
 Tissue Forceps..... GEN-98
- JUDY FRIEDMAN**
 Face Lift Scissors ENT-127
- JUERS**
 Crimper Forceps..... ENT-46
- JUERS-LEMPERT**
 Rongeur ENT-121
- JULIAN**
 Classic Plus® Needle Holders..... CVT-130, GEN-162

K

- Needle Holder GEN-162
Thoracic Artery Forceps..... CVT-98, GEN-76
- KAHN**
Uterine Trigger Cannula OBGYN-30
- KANTROWITZ**
Forceps..... CVT-117, GEN-76
- KARLIN™**
Cervical Curette..... NEU-8, SPN-17
Cervical Curette Set SPN-81
Cervical Spanner SPN-62
Crank Frame Spinal Retractor Set..... SPN-115
Curved Stiletto to Chisel Set with Case O/A-54-55
Curved Stiletto to Osteotome Set with Case SPN-78
Instrument Cases SS-39-40
Lumbar Microdiscectomy Instruments..... OBE-12
Lumbar Nerve Hook..... OBE-36
Magnum Cobb Elevator Set SPN-82
Magnum Cup Curette..... SPN-18-19
Magnum Cup Curette Kit..... SPN-74
Magnum Ring Curette..... SPN-24
Mallet O/A-59, SPN-85
Micro Knife Handle SPN-84
Micro Nerve Hook NEU-47
PG Magnum Case OBE-8
PG Magnum Cobb Elevator OBE-21-22
PG Magnum Cup Curette OBE-14-15
PG Magnum Ring Curettes..... OBE-17, OBE-18
Spinal Retractors RET-125-126
Stiletto Osteotome SPN-94
XL Bone Cutter SPN-38
XL Magnum Case..... OBE-9
XL Magnum Cobb Elevator..... OBE-21-22, SPN-52
XL Magnum Cup Curette..... OBE-16, OBE-17
XL Magnum Ring Curettes OBE-18
- KARTCHNER**
Carotid Clamp..... CVT-24
- KASDAN**
Hand Retractor GEN-225, RET-91
- KATZIN**
Corneal Transplant Scissors OPH-56
- KAY**
Aorta Anastomosis Clamp..... CVT-11
- KAYE**
Ceramic Coated Scissors GEN-257
Dissecting Scissors ENT-124
Knife Handle..... GEN-132
Scissors ENT-131, GEN-256
- KELLAN**
Hydrodissection Cannula..... OPH-5
- KELLY**
Artery Forceps..... GEN-29
Classic® Hemostatic Forceps CVT-87, GEN-54,
PED-11
Placenta Forceps GEN-55, OBGYN-22
- Retractor..... O/A-82
Retractor Blade CVT-141, CVT-157, CVT-181,
GEN-187, GEN-226, OBE-48-49, OBE-54, RET-10,
RET-29, RET-51
Universal Ring Retractor Blade..... GEN-205
- KELLY-GRAY**
Endocervical and Endometrial Biopsy Curette
OBGYN-5
- KELMAN**
Cyclodialysis Cannula OPH-5
- KELMAN-MCPHERSON**
Tying Forceps OPH-20
- KERN**
Bone Holder Forceps O/A-36
- KERRISON**
Ceramic Coated Rongeurs SPN-156-159,
SPN-178-180
Cervical Rongeurs SPN-172-175
Convertible Rongeurs ... SPN-162-163, SPN-169-170,
SPN-178-180
Laminectomy Rongeur SPN-138, SPN-176
Lumbar Rongeurs SPN-160-161, SPN-181-182
Micro Rongeur NEU-88-90, NEU-97-101,
SPN-155-159, SPN-162-170, SPN-178-180
MicroClean Cervical Rongeurs NEU-102
Opti-Length® Rongeur SPN-171
Rongeur ENT-119, NEU-96, OBE-69, OBE-71,
PED-32, SPN-155-184
- KERRISON-COSTEN**
Rongeur ENT-119
- KEVORKIAN-TISCHLER**
Biopsy Punch..... OBGYN-33
- KEVORKIAN-YOUNGE**
Uterine Biopsy Forceps..... OBGYN-23
Endocervical Biopsy Curette..... OBGYN-5
- KEY**
Periosteal Elevator O/A-25, NEU-24, SPN-52-53
- KEYES**
Dermal Punch..... GEN-176
- KIELLAND**
Obstetrical Forceps..... OBGYN-21
- KIELLAND-LUIKART**
Obstetrical Forceps..... OBGYN-21
- KILLIAN**
Antrum Cannula..... ENT-4
Septum Speculum..... ENT-140, RET-108
- KILNER**
Skin Hook ENT-69, GEN-128
- KING**
Adenoid Punch ENT-95
- KIRBY**
Intra-Capsular Lens Loop OPH-36

KIRK

Mallet.....O/A-59

KIRSCHNERBow.....O/A-111
Wire Cutter..... GEN-329, SPN-193**KITS**Anterior Fusion..... SPN-72
Calcar Driver..... O/A-50
Cervical Curette.....SPN-81
Curved Stiletto Osteotome Set with Case..... SPN-78
FlashPak® Refurbish..... O/A-50
Flexible Osteotome.....O/A-51
Hip Retractor.....O/A-52
Hip Revision.....O/A-51
Karlin™ Curved Stiletto Osteotome.....O/A-52
Karlin™ XI Magnum Cup Curette..... SPN-74
Knee Retractor System.....O/A-53
Lumbar Microdiscectomy Set..... SPN-75
Lumbar Spondylophyte Impaction Set..... SPN-76
Magnum Cobb Elevator Set.....SPN-82
Magnum Ring Curette..... SPN-77
Micro Impactor Set..... SPN-76
Microsect® Curette Set.....SPN-83
Microvascular STA-MCA..... NEU-127
MultiPak Metal Carrying Handles.....O/A-53
PLIF II Instrument Kit..... SPN-73
Screw Removal.....O/A-54
Stiletto Chisel.....O/A-53-55
Tibial Impaction.....O/A-55
Transoral Instrument Set..... SPN-79
Trepine.....O/A-56
Universal Shoulder Arthroplasty.....O/A-56
Vertebral Body Biopsy..... SPN-80**KITTNER**

Secto® Dissectors..... GEN-21, NEU-12

KLEINERT-KUTZElevator & Dissector.....O/A-25, SPN-53
Rasp.....ENT-104
Skin Hook..... GEN-129
Synovectomy Rongeur..... ENT-120, O/A-105-106,
SPN-142**KLEINSASSER**Cutting Forceps.....ENT-46
Laryngeal Suction Tube.....ENT-147
Micro-Laryngeal Scissors..... ENT-129**KNAPP**Dissecting Scissors..... GEN-263
Eye Speculum..... OPH-71
Iris Scissors.....ENT-127, GEN-287
Retractor..... ENT-108, GEN-227, RET-52
Scissors..... GEN-287, OPH-57, PED-36**KNIFE GUIDES**

Neivert Knife Guide & Retractor..... RET-54

KNIFE HANDLESGeneral Purpose..... CVT-121, ENT-64, GEN-131-134,
NEU-136, OBE-36, SPN-84
Javelin Micro.....GEN-132
Micro..... NEU-53
Transsphenoidal..... NEU-53**KNIGHT**

Nasal Scissors..... ENT-130

KNIVESAngled..... NEU-54
Arachnoid..... NEU-54
Arthroscopic.....O/A-57
Button End.....ENT-72
Canal..... ENT-72, ENT-74
Cartilage..... ENT-73, ENT-74
Cordotomy..... NEU-54
Corneal..... OPH-35
Ear.....ENT-73
Ganglion..... NEU-54
Golf Stick.....GEN-131
Micro-Laryngeal.....ENT-73
Microvascular Arachnoid.....NEU-55
Middle Ear..... ENT-74-77
Myringotomy..... ENT-75-77
Nasal..... ENT-77-78
Septum.....ENT-78
Sinus.....ENT-78
Sternum.....CVT-122
Tonsil..... ENT-78-79
Tumor.....NEU-55**KNOT PUSHERS**Bariatric.....LAP-22
Laparoscopic.....LAP-24, LAP-28-29**KOCHER**Baby Forceps..... GEN-55
Delicate Classic® Forceps..... CVT-116, GEN-54
Forceps..... PED-9, PED-12
Grasping Forceps.....LAP-13
Hemostatic Forceps..... CVT-88 GEN-55
Intestinal Forceps..... GEN-56, OBE-28**KOGAN**

Endocervical Speculum.....OBGYN-45

KOLBELRetractor.....O/A-82, RET-66
Soft Tissue Retractor.....O/A-94**KOS**

Pick..... ENT-93

KRAFFCapsule Polishing Curette.....OPH-8
Forceps.....OPH-20**KRATZ**Capsule Scraper.....OPH-6
Lens Manipulator Cannula.....OPH-6**KRATZ-BARRAQUER**

Speculum.....OPH-70-71

KREMER

Fixation Forceps.....OPH-20

KRISTELLER

Vaginal Speculum.....OBGYN-51

KUGLEN

Titanium Push/Pull Hook.....OPH-33

L

LABORDE

Tracheal DilatorENT-18, GEN-20

LAFORCE

AdenotomeENT-2

LAHEY

Delicate Scissors CVT-193
 Forceps CVT-117
 Goiter Tenaculum GEN-51
 Goiter Traction Forceps GEN-51
 Hemostatic Forceps GEN-98, PED-12
 Retractor GEN-227, O/A-83, RET-147
 Scissors GEN-263
 Thyroid Retractor ENT-116

LAHEY CLINIC

Dural Hook NEU-45, PED-17

LALONDE

Skin Hook Forceps GEN-68

LAMBERT

Chalazion Forceps OPH-20

LAMBERT-KAY

Aorta Clamp CVT-11

LAMBOTTE

Mini Osteotome SPN-91
 Osteotome O/S-65-66, SPN-89-90

LANCASTER

Eye Speculum OPH-70

LANDOLT

Knife Handle ENT-64

LANE

Elevator SPN-53
 Periosteal Elevator O/A-25

LANGENBECK

Periosteal Elevator GEN-25, NEU-24, O/A-26,
 SPN-53
 Retractor GEN-227, O/A-83, RET-52

LAPAROSCOPIC

Accessories & Miscellaneous LAP-22-31
 Bookwalter® OBE-37
 Dissectors LAP-6-7, LAP-13, LAP-16-17, LAP-19-20
 Electrodes ENG-33
 Forceps ENG-35-49, LAP-4-18, LAP-20,
 LAP-34-89
 General LAP-2-3, LAP-5, LAP-8, LAP-11-14,
 LAP-17-19
 Lap Handle, Insulated ENG-44
 Monopolar Electrodes ENG-51
 Scissors ENG-42, ENG-44, ENG-49
 Sterilization Systems LAP-94-95
 Tenaculums LAP-21

LARRY

Rectal Probe REC-4

LARYNGOSCOPE HOLDERS ENT-79

LAUFE

Uterine Polyp Forceps OBGYN-24

LAWRENCE

Forceps CVT-117, GEN-98

LAWRIE

Modified Circumflex Scissors CVT-202

LEBSCHER

Sternum Knife CVT-122

LEES

Bronchus Clamp CVT-18, OBE-4

LEFORT

Urethral Sound URO-6

LEHNER-UTRATA

Capsulorhexis Forceps OPH-21

LEISKE-SMITH

Lens Pusher OPH-30

LEKSELL

Laminectomy Rongeur NEU-106, SPN-177
 Rongeur ENT-122, NEU-106, O/A-98, OBE-72-73,
 SPN-138

LELAND-JONES

Peripheral Vascular Clamps CVT-40, CVT-41

LEMMON

Intima Dissector CVT-68

LEMPERT

Bone Curette ENT-10
 Elevator ENT-28
 Rongeur ENT-122, NEU-85, NEU-107, O/A-99,
 SPN-138-139

LENS CRACKERS OPH-35

LENS PUSHERS OPH-30

LERICHE

Artery Forceps GEN-29

LESTER

Fixation Forceps OPH-21
 Hook OPH-30
 Lens Pusher OPH-30

LESTER-BURCH

Speculum OPH-71

LEWICKY

Lens Manipulating Hook OPH-31

LEWIN

Bone Forceps O/A-36

LEWY

Laryngoscope Holder ENT-79

LEXER

Chisel O/A-5, SPN-5
 Gouge O/A-44

- LEYLA**
Brain Retractors NEU-78-79, RET-84
- LIDDICOAT**
Aortic Valve Retractor CVT-138, RET-33
- LIEBERMAN**
Speculums OPH-71, RET-88
- LIGATORS**
Hemorrhoidal REC-3
- LIGATURE INSTRUMENTS**
Carrier NEU-56
Passer NEU-56
- LILLIE**
Ear Hook ENT-65
- LINCOLN**
Scissors CVT-194, GEN-263
- LISTER**
Bandage Scissors CVT-189, GEN-254
- LISTON**
Bone Cutting Forceps NEU-30, O/A-34, PED-32,
SPN-59
Bone Cutting Rongeur CVT-187
- LISTON-KEY**
Bone Cutting Forceps O/A-34
- LITTAUER**
Stitch Scissors CVT-205, GEN-295, PED-39
- LITTLER**
Suture Carrying Scissors ENT-133
- LITWAK**
Mitral Valve Scissors CVT-202, GEN-304, OBE-77
- LLETZ**
Electrodes ENG-52
- LOCKE**
Elevator O/A-26
Phalangeal Forceps O/A-40
- LOCKWOOD-ALLIS**
Tissue Forceps CVT-108, GEN-99
- LOOP APPLICATOR** LAP-28
- LOOPS**
Ear ENT-79
Endarterectomy CVT-122
Ophthalmologic OPH-36
- LORE**
Suction Tube Holding Forceps CVT-112
Suction Holding Clamp GEN-4
- LORNA (EDNA)**
Towel Clamp GEN-13
- LOTHRUP**
Uvula Retractor ENT-117
- LOUTE**
Wire Tightener O/A-111
- LOVE**
Nerve Root Retractor GEN-228, SPN-130
Retractors RET-134, RET-150
Uvula Retractor ENT-117
- LOVE-ADSON**
Periosteal Elevator GEN-25, NEU-24, O/A-26
- LOVE-GRUENWALD**
Intervertebral Disc Rongeur NEU-97, OBE-68,
SPN-148-150
- LOVELACE**
Lung Grasping Forceps CVT-91, GEN-64
- LOWMAN**
Bone Holding Clamp O/A-7
- LOWSLEY**
Tractor OBGYN-30
- LUCAE**
Bayonet Dressing Forceps ENT-48, GEN-48
Ear Forceps GEN-32, PED-10
Nerve Hook GEN-127, NEU-48
- LUCAS**
Curette ENT-11
- LUER**
Bone Rongeur NEU-86, O/A-99-100, SPN-139
Laminectomy Rongeur SPN-140
Lock Capo LAP-26
- LUETJE**
Alligator Scissors ENT-124
- LUKENS**
Thymus Retractor ENT-116
-
- M**
- M.D. ANDERSON**
Clamp OBGYN-2
- MACKOOL**
Lens Capsule Retractor RET-86
- MAGILL**
Catheter Forceps GEN-41
- MAGNAFREE®**
Crile Forceps CVT-118
Dissector NEU-12, SPN-42
Dressing Forceps CVT-82
Elevator & Spatula GEN-21, NEU-22
Forceps GEN-114-116, PED-13
MRI Mayo Scissors CVT-200, GEN-263
MRI Mayo-Hegar Needle Holders .CVT-130, GEN-147
Penfield Dissector CVT-69
Sponge Forceps CVT-118
Tissue Forceps CVT-108, GEN-112
- MAGNUM**
Chisel Sets SPN-5
Cobb Elevator Set SPN-54
Ring Curette Case SPN-10

- Ring Curette Kit..... SPN-77
Storage/Sterilizing Case..... SPN-12
- MAHORNER**
Thyroid Retractor..... ENT-116, GEN-250, RET-148
- MALIK**
Cystic Duct Forceps..... GEN-42
- MALIS®**
Bayonet Bipolar Forceps..... ENG-17, GEN-38
Bayonet Needle Holder..... NEU-57-58
Bayonet Scissors..... NEU-113
Brain Retractor Kit..... NEU-80
Cerebellar Retractor..... NEU-80
Connector..... NEU-81
Cup Forceps..... NEU-31
Curette..... NEU-11
Dissector..... NEU-15
Double Connector..... RET-85
Elevator..... GEN-21, NEU-26
Forceps..... GEN-33, NEU-42-43
Hinge Clamp..... CVT-31, NEU-81
Ligature Passer..... NEU-56
Needle Holder..... GEN-148, NEU-60
Nerve Hook..... NEU-48-49, OBE-36
Neurosurgical Scissors..... GEN-290, NEU-117
Retractors..... RET-37, RET-78
Scissors..... GEN-290, NEU-119
Vessel Supporter..... NEU-84, RET-159
- MALIS®-FRAZIER**
Suction Tube GEN-322, NEU-129, NEU-132, PED-44
- MALIS®-JENSEN**
Bayonet Bipolar Forceps..... GEN-39
- MALLETS**..... NEU-56, O/A-57-62, SPN-85
Cervical..... SPN-84
Orthopedic..... O/A-61
Percussion..... NEU-56
Sinus & Nasal..... ENT-79
- MALONEY**
No Hole IOL Manipulator..... OPH-37
- MALTZ**
Cartilage Knife..... ENT-73
Rasp..... ENT-104-105
- MALTZ-JOSEPH**
Saw..... ENT-123
- MALTZMAN-FENZL**
Lens Manipulating Hook..... OPH-31
- MANIPULATORS**
Arthroscopic..... O/A-62
Ophthalmologic..... OPH-37-38
Uterine..... OBGYN-29-30
- MANSON**
Double Hook..... OPH-31
- MARKERS**
Ophthalmologic..... OPH-39
Surgical..... CVT-122, GEN-135, NEU-57
- MARKHAM-MEYERDING**
Hemilaminectomy Retractor..... GEN-245, RET-121
Retractor..... O/A-83, SPN-98
- MARTIN**
Cartilage Clamp..... O/A-8
Cartilage Scissors..... O/A-106
Laryngectomy Tube..... ENT-148
Tissue Forceps..... CVT-108, GEN-99
- MARTINI**
Bone Curette..... SPN-13
- MARYLAND**
Dissecting Forceps..... ENG-43, ENG-46, ENG-48,
LAP-49, LAP-58, LAP-65, LAP-71-72, LAP-79-80,
LAP-86
Dissector..... ENG-39, ENG-46, LAP-13
Forceps with Cross Serrations..... LAP-18
- MASHER**
Thoracoscopy Grasping Forceps..... CVT-84
- MASKET**
Capsulorhexis Forceps..... OPH-21
- MASSON**
Needle Holder..... GEN-162, OBE-38
- MASTERS**
Intestinal Clamp..... GEN-9, OBE-5
- MASTERSON**
Hysterectomy Forceps..... GEN-7, OBGYN-18
Pelvic Clamp..... GEN-8, OBE-6, OBGYN-4
- MASTERS-SCHWARTZ**
Liver Clamp..... CVT-34, GEN-10, OBE-6
- MATHIEU**
Needle Holder..... GEN-162
Retractor..... CVT-181, GEN-228, RET-52
- MATSON**
Rib Raspatory..... CVT-137
- MATTHEWS**
Drill Point..... NEU-19
- MATTOX**
Aorta Clamp..... CVT-11
- MATTOX-POTTS**
Scissors..... CVT-211, PED-41
- MAUMENEE**
Corneal Forceps..... OPH-21
Vitreous Aspirating Needle..... OPH-40
- MAUMENEE-PARK**
Speculum..... OPH-72, RET-88
- MAXWELL**
Flap Retractor..... RET-75
- MAYO**
Abdominal Retractor..... GEN-228, RET-53
Ceramic Coated Scissors..... GEN-267
Classic® Dissecting Scissors..... GEN-266
Classic® Scissors..... CVT-192, GEN-258
Common Duct Scoop..... GEN-308

- Dissecting Scissors CVT-195, GEN-264-266
Instrument Stringer GEN-312
MagnaFree® MRI Scissors.....CVT-200, GEN-263
Micro-Serration Razor Edge Scissors GEN-268
Razor Edge Serrated Scissors..... GEN-268
Scissors CVT-195, OBE-74, PED-33-34, PED-37
Serrated Scissors.....GEN-267
Ultra™ Swivel BladeCVT-159, GEN-207
Vein Stripper CVT-222
- MAYO BUNT**
Instrument Holder..... CVT-61
- MAYO CARROLL**
Scissors GEN-264
- MAYO-GUYON**
Kidney ClampGEN-10
- MAYO-HARRINGTON**
Dissecting ScissorsCVT-195, GEN-269, OBE-76
Scissors GEN-269
Serrated Scissors..... GEN-266
- MAYO-HEGAR**
Classic Plus® Needle Holders CVT-131
MagnaFree® MRI Needle Holders..CVT-130, GEN-147
Needle Holders.....CVT-131, GEN-163-164, OBE-39,
PED-20
Titanium Needle Holder..... GEN-148
- MAYO-NOBLE**
Dissecting Scissors GEN-270
ScissorsCVT-196
- MAYO-ROBSON**
Gastrointestinal Forceps..... GEN-51
- MAYO-RUSSIAN**
Tissue Forceps..... CVT-109, GEN-99
- MAYO-STILLE**
Ceramic Coated Scissors GEN-270
Dissecting Scissors GEN-269
Micro-Serration Razor Edge Scissors GEN-270
Serrated Scissors..... GEN-270
- MCBURNEY**
Thyroid Retractor GEN-228, GEN-250, RET-148
- MCCABE**
Canal Knife.....ENT-74
Facial Nerve Dissector.....ENT-19
Flap Knife DissectorENT-19
- MCCREA**
Infant Urethral SoundPED-42, URO-6
- MCCULLOCH**
Ball Probe SPN-95
Elevator ENT-28
Foraminal Probe.....SPN-96
Hinged Retractor SPN-123
Hook Blade SPN-124-125
Narrow Muscle Retractor Blade SPN-126
Nerve Root Elevator..... SPN-55
Nerve Root Retractor SPN-131
Osteotome SPN-90
Retractors (Spine)..... RET-127-132
- Rigid RetractorSPN-123
Single Cervical BladeSPN-127
Thin Muscle Blade.....SPN-125
Wide Muscle Retractor Blade.....SPN-127-128
- MCCULLOCH-COBB**
Elevator SPN-55
- MCCULLOUGH**
Utility Forceps..... OPH-21
- MCDOUGAL**
Prostatectomy ClampURO-4
- MCELROY**
Angulated Retractor.....O/A-83, RET-91
- MCGEE**
Oval Window Rasp..... ENT-101
Perforating Needle..... ENT-83
Pick..... ENT-92
Wire Crimper Forceps..... ENT-55
- MCGIVNEY**
Hemorrhoidal Ligator Set.....REC-3
- MCGLAMARY**
Metatarsal Elevator.....O/A-20
- MCINDOE**
Bone Cutting ForcepsO/A-34
- MCINTYRE**
Anterior Chamber Cannula..... OPH-7
- MCINTYRE-BINKHORST**
Irrigating Cannula..... OPH-7
- MCIVOR**
Mouth Gag & Tongue BladeENT-81
- MCKENTY**
Periosteal ElevatorENT-25, O/A-26, SPN-55
Sphenoid Punch ENT-100
- MCKENZIE**
Enlarging Burr.....NEU-19
Perforator Drill NEU-20
- MCKERNAN**
Tri-Grasping Fenestrated ForcepLAP-6
- MCKESSON**
Mouth Prop..... ENT-83
- MCLEAN**
Obstetrical Forceps.....OBGYN-21
- MCLEAN-TUCKER**
Obstetrical Forceps.....OBGYN-22
- MCPHERSON**
Bipolar Forceps ENG-11, ENG-24
Needle Holder OPH-43
Tying Forceps OPH-22
- MCPERSON IRIS**
Bipolar Forceps GEN-36, GEN-39
- MCPERSON-VANNAS**
Iris Scissors OPH-58

- MEAD**
Mallet O/A-60
- MEAH**
Grasper LAP-19
- MEASURING TAPE** GEN-252
- MEEKER**
Deep Surgery Forceps CVT-78, GEN-100, OBGYN-15
Forceps CVT-118, GEN-99, OBE-25-26
- MEIGS**
Uterine Curette OBGYN-7
- MELTZER**
Adenoid Punch ENT-96
- MENDEZ**
Degree Gauge OPH-27
- MESH**
Burr Holder SS-45
- METAPAK**
Tray, Middle Ear ENT-8
- METHODIST**
Vascular Suction Tube .. CVT-224, GEN-322, OBE-81
- METZENBAUM**
Ceramic Coated Scissors GEN-271, GEN-276
Classic Plus® Dissecting Scissors CVT-196, GEN-272-273
Classic® Scissors CVT-192
Delicate Scissors CVT-193
Dissecting Scissors CVT-197, GEN-258, GEN-273-274
Endo Scissors LAP-72
Micro-Serrated Scissors GEN-272, GEN-276, GEN-277
Razor Edge Tenotomy Scissors GEN-296
Reposable Scissors LAP-26
Scissors ENG-42, GEN-271, GEN-274, LAP-42 LAP-65, OBE-75-76, PED-34
Scissors
Serrated Scissors GEN-272, GEN-275
Thoracoscopy Dissecting Scissors CVT-197
- MEYERDING**
Finger Retractor GEN-213, GEN-215, O/A-84
Finger Hook-Retractor GEN-125
Hip & Shoulder Skid O/A-107, RET-94
Laminectomy Retractor GEN-229, GEN-246, OBE-65, SPN-121
Retractor GEN-229, RET-29, RET-42, RET-123
Universal Ring Retractor Blade GEN-205
- MEYERHOEFFER**
Curette OPH-8
- MGH**
Uterine Vulsellum Forceps OBGYN-26
- MICHELE**
Trepines NEU-137, SPN-192
- MICROCARE®**
Bayonet Case CVT-57
Flex Mat CVT-58
Instrument Cases CVT-58-59, SS-40-43
- MICROPAK** SS-19-20
Classic Series II Containers CVT-59
- MICROSECT®**
Curette SPN-37
Curette Set SPN-93
Curette Tray SPN-10, SS-42
Shaver Rongeurs SPN-170, SPN-171
Shavers NEU-107
- MICROVASC®**
Instrument Case SS-43
- MIDDLETON**
Adenoid Curette ENT-9
- MILLARD**
Thimble Hook ENT-70
- MILLER**
Bone Files O/A-32
Bone Rasp NEU-64, SPN-96
Rake Retractor RET-53
- MILLET**
Neurological Test Instrument NEU-134
- MILLIGAN**
Dissector CVT-69, NEU-12, SPN-40
- MIRRORS**
Laryngeal ENT-80
Middle Ear ENT-80
Transsphenoidal NEU-57
- MISKIMON**
Cerebellar Retractor ... GEN-213, GEN-245, NEU-64, RET-37, RET-39
- MITCHELL**
Aorta Clamp CVT-12
- MIXTER**
Classic® Hemostatic Forceps GEN-102, PED-12
Dissecting Forceps LAP-50, LAP-58, LAP-72, LAP-81, LAP-86-87
Dissector LAP-7, LAP-20
Forceps CVT-119, GEN-102
Gallbladder Forceps CVT-83, GEN-102
Operating Scissors CVT-203, GEN-278
Pediatric Hemostatic Forceps CVT-88
Right Angle Clamp GEN-7
Right Angle Dissector ENG-39, ENG-46, ENG-47
Thoracic Clamp CVT-46, GEN-12, OBE-7
- MIXTER-CRAFOORD**
Dissecting Forceps GEN-42
- MIYA**
Hook OBGYN-28
- MOBILIZERS**
Middle Ear ENT-80
- MOGEN**
Circumcision Clamp OBGYN-4

MOLT

Periosteal ElevatorENT-25, GEN-25, NEU-25
SPN-55, O/A-19

MORRIS

Aorta Clamp CVT-12

MORSE

Sternal Retractor CVT-176, PED-30, RET-146

MOUTH GAGS**RET-75**

Tonsil & LaryngealENT-81-83

MOYNIHAN

Gallbladder Duct ForcepsGEN-50

MULTIPAK**SS-21-28**

Bone Impactor O/A-49

Endoscopic KitO/A-11

Metal Carrying Handle KitO/A-53

Silicone Bar Holder LAP-32

MULTIPAK IIISS-29-30

MURLESS

ExtractorOBGYN-13

MURPY

Ball Hook NEU-43

Gall Bladder Retractor GEN-214

RetractorsENT-108, GEN-229, O/A-83, RET-41,
RET-53

MURPHY-LANE

Bone RetractorRET-90

Bone Skid Retractor O/A-107

MURRAY

Grasper LAP-18

MYOMA SCREW LAP-27

N

NAIL NIPPERS GEN-135-137

NAIL SPLITTERS GEN-138

NATHANSON

Flex Arm LAP-23

Retractor Hooks LAP-27

NEEDLE HOLDERS

BariatricGEN-155

Bayonet GEN-152, NEU-57-58

Cardiovascular Tourniquets GEN-145

Double Action GEN-138

Dual Purpose PED-8

DuralGEN-152, NEU-59

Extra FinePED-18

with ForcepsCVT-127

French Eye GEN-158

General Purpose ...CVT-123, CVT-127-134, GEN-143,

GEN-152-171, NEU-60, OBE-38-40, OBGYN-30-31

I.M.A.PED-18

IntracardiacGEN-160, OBE-40

LaparoscopicLAP-28-31, LAP-52

MicroCVT-123-126,

GEN-139-144, GEN-146-147, GEN-149, GEN-157,

NEU-59-60, OPH-43-44, PED-19

Microsurgical PED-19

Microvascular CVT-131, GEN-143-144

NeurovascularNEU-59

OphthalmologicOPH-41-44

Pediatric PED-19-20

with ScissorsGEN-138

SternalGEN-151

Thoracoscopy CVT-134

Titanium GEN-145-150, NEU-58, OPH-43-44

Total Occlusion CVT-134, GEN-171, PED-19

Tungsten CarbideLAP-52

Wire Twister GEN-150-151

NEEDLES

General Purpose GEN-172

Heparin CVT-135, GEN-172

Laparoscopic LAP-30-31

Middle Ear ENT-83-84

Ophthalmologic OPH-3, OPH-40

Puncture Needle with Aspiration LAP-30

Septum ENT-85

Straight Point NEU-61

Tonsil ENT-85

Ventricular NEU-61

Vertebral Biopsy SPN-2

NEIVERT

Knife Guide & Retractor RET-54

Needle HolderGEN-165

Osteotome ENT-87

NELSON

Classic Plus® Scissors... CVT-207, GEN-278, OBE-75

Scissors CVT-197, GEN-279

Tissue ForcepsGEN-102

NELSON METZENBAUM

Dissecting ScissorsGEN-278

Micro-Serrated Razor Edge ScissorsGEN-279

ScissorsGEN-279, OBE-76-77

NELSON (PATTERSON)

TrocarCVT-225

NEW

Suture Scissors CVT-206, GEN-295

NEW ORLEANS

Needle HolderGEN-165

NEW ORLEANS EYE & EAR

Lens Loop OPH-36

NEWS

Tracheal HookENT-70, RET-149

Tracheal Hook Retractor GEN-250

NICOLA

Micro Pituitary Curette NEU-9

NIGHTINGALE

Capsule Polishing CuretteOPH-8

NIPPERS

Malleus ENT-85

Middle Ear ENT-85

NISSEN

Artery Forceps..... CVT-72, GEN-28

NOONA-V Fistula Case CVT-59
A-V Fistula Clamp CVT-17, PED-2
A-V Fistula Tunneler CVT-226
Instrument Case SS-43**NORDAN**

Titanium Tying Forceps..... OPH-24

NOVAK

Endometrioum Biopsy Suction Curette OBGYN-5

NOYESEar Forceps ENT-48
Nasal Dressing Forceps ENT-56**NUCLEUS ROTATORS** OPH-27**NUGENT**

Utility Forceps GEN-103, OPH-22, PED-49

O**OBERHILL**

Retractor O/A-84, RET-66, SPN-98

OBTURATORS CVT-135, GEN-316**OBGEWESER**Periosteal Elevator ENT-25
Push Pull Rasp ENT-102
Retractor RET-54
Zygomatic Arch Awl ENT-3**OCHSNER**Aorta Clamp..... CVT-12, OBE-3
Trocar GEN-328
Vascular Retractor CVT-177, RET-157
Wire Twister CVT-227**O'CONNOR**

Scleral Depressor-Marker OPH-9

O'CONNOR-O'SULLIVAN

Abdominal Retractor GEN-183-184, RET-7

O'GAWA

Tying Forceps OPH-22

OLDBERGDissector O/A-19, SPN-40
Intervertebral Disc Rongeur SPN-150
Retractor RET-53
Rongeur NEU-101**OLIVECRONA**Double-Ended Dissector..... NEU-12
Rongeur NEU-109, O/A-100**OLIVECRONA-GIGLI**

Wire Saw NEU-112

OLLIERRetractor CVT-181, GEN-229, O/A-84, OBE-49,
RET-54**OLSEN®**Electrode Extenders ENG-51
Electrosurgical Cords ENG-58-59
Energy Accessories ENG-64-65
Exposed Top Forceps ENG-60
Monopolar Adaptors ENG-61
Monopolar Blade Electrodes ENG-50
Monopolar Electrodes ENG-31-33
Monopolar Loop Electrodes..... ENG-52
Monopolar Needle Electrodes..... ENG-53-57
Monopolar Pencils ENG-62-63
Reusable Bayonet Monopolar Forceps ... ENG-27-28
Reusable Monopolar Forceps ENG-29-30
Single-Use Bipolar Forceps ENG-3-11
Single-Use Monopolar Forceps..... ENG-26
Suction Coagulators ENG-57**OLSEN®/ULTRA™**

Reusable Bipolar Forceps..... ENG-12-25

OLSEN-HEGARClassic Plus® Needle Holder & Scissors..... CVT-131,
PED-8
Needle Holder GEN-165-166**OSHER**Nucleus Manipulator OPH-38
"Y" Hook OPH-32**OSHER-NEUMANN**

Corneal Marker OPH-39

OSTEOTOMES..... ENT-86-88, ENT-88-89, O/A-51,
O/A-62-70, OBE-41, SPN-86-94Spinal..... NEU-61, SPN-86, SPN-91
Siletto SPN-94**O'SULLIVAN-O'CONNOR**Abdominal Retractor OBGYN-33, OBGYN-34
Blade Retractor OBGYN-34
Vaginal Retractor OBGYN-51
Wing Nuts..... OBGYN-34**OTIS**

Urethrotome Set..... URO-5

OVERHOLT

Dissecting & Ligature Forceps GEN-42

P**PACIFICO**Sternal Retractor CVT-177, RET-146
Suction Tube..... CVT-223 GEN-322**PACKERS**

Bone Chip SPN-95

PAPARELLADrum Elevator ENT-22
Duckbill Elevator ENT-23
Incudostapedial Joint Knife..... ENT-75
Instrument Rack..... ENT-8
Pick ENT-92
Ring Curette ENT-16
Sickle Knife ENT-77

- PAR**
 Needle Holder..... GEN-166
 Razor Edge Scissors..... GEN-257
 Scissors..... GEN-257
- PARKER**
 Retractors..... CVT-182, GEN-230, O/A-84, RET-54
- PARKER MOTT**
 Retractor..... GEN-230, RET-54
- PARKES**
 Rasp..... ENT-105
- PARSONNET**
 Aorta Clamp..... CVT-12
 Epicardial Retractor..... PED-23, RET-34
- PAUFIQUE**
 Forceps..... OPH-22
- PAYR**
 Pylorus Clamp..... GEN-11
- PEAN**
 Classic® Delicate Hemostatic Forceps..... CVT-119,
 GEN-56
- PEANUT**
 Secto® Dissectors..... GEN-21
- PEAPOD**
 Intervertebral Disc Rongeur..... NEU-101, PED-31,
 SPN-151
- PEDERSON**
 Vaginal Speculum..... OBGYN-51-52
- PEERS**
 Non-Perforating Towel Clip..... GEN-13
- PEET**
 Nasal Rasp..... ENT-101
 Splinter Forceps..... GEN-70
- PENFIELD**
 Dissectors..... CVT-69, NEU-16, OBE-19, SPN-40-42
 MagnaFree® Dissector..... NEU-12
 Watchmaker Forceps..... GEN-103, NEU-41
- PENNINGTON**
 Clamp..... CVT-54, GEN-5
 Elevator..... ENT-29
 Forceps..... GEN-103
 Grasping Forceps..... LAP-50
 Rectal Speculum..... REC-8
 Thoracoscopy Grasping Forceps..... CVT-84
- PERKINS**
 Retractor..... ENT-108, RET-66
- PHANEUF**
 Artery Forceps..... CVT-74, GEN-29
 Uterine Artery Forceps..... GEN-118, OBGYN-24
- PICKS** **O/S-70**
 Middle Ear..... ENT-89-93
- PIERCE**
 Elevator..... ENT-29
 Eye Speculum..... OPH-72
- PIN WHEELS**..... GEN-173
- PINS**
 Distraction..... SPN-95
- PISACANO**
 Nucleus Rotator..... OPH-49
- PLAQUE REMOVER**..... CVT-94-95
- PLATES**
 Ophthalmologic..... OPH-45
- PLIERS** **CVT-136, GEN-173-174**
 Pin Pulling..... SPN-191
 Spine..... SPN-191
 Vice Grips..... CVT-135, OBE-42
 Wire Extraction..... SPN-191
- PLIF II**
 Instrument Case..... SS-43
- POLOCK**
 Finger Goniometer..... GEN-123
- POOLE**
 Suction Tube..... CVT-223, GEN-323, OBE-79
- POPPEN**
 Saw Guides..... NEU-110
- POPPEN-GELPI**
 Laminectomy Retractor..... GEN-246, PED-25,
 RET-124, SPN-121
- POSILOCK**
 Instrument Stringer..... GEN-312
- POTTS**
 Razor Edge Scissors..... GEN-296
 Tenotomy Scissors..... ENT-134, GEN-301, GEN-306
- POTTS-SMITH**
 Bipolar Forceps..... ENG-24, ENT-38
 Ceramic Coated Scissors..... CVT-211, GEN-306
 Dissecting Scissors..... CVT-197
 Dressing Forceps..... CVT-82, GEN-49
 Forceps..... ENG-60, OBE-25, OBE-32
 Monopolar Forceps..... ENG-30
 Razor Edge Scissors..... CVT-214, GEN-306
 Scissors..... CVT-211-214, GEN-305
 Tissue Forceps..... CVT-109-110, GEN-104
- PRATT**
 Probes..... REC-3, REC-4
 Rectal Speculum..... REC-9
 Uterine Dilator..... OBGYN-12
- PRESBYTERIAN HOSPITAL**
 Elevator..... NEU-26
 Staphylorrhaphy Elevator..... GEN-26, NEU-26
 Tubing Clamp..... GEN-14
- PRESSES**..... ENT-93
- PREVAC**
 Base & Lid..... LAP-94

PRIBRAM

Suction Tube with Thumb Control GEN-323,
NEU-133, PED-44

PRINCE

Tonsil Scissors ENT-135

PROBES

Arthroscopic O/S-71
Ball NEU-62, SPN-95
Double-Ended GEN-175-176
Double Forked NEU-62
Fistula REC-3
Foranimal SPN-96
General Purpose GEN-175-176, NEU-63
Lacrimal OPH-45, OPH-46, PED-21
Laryngeal ENT-94
Lumbar SPN-96
Measuring OBGYN-31
Micro NEU-62
Ophthalmologic OPH-45-46
OS OBGYN-31
Palpation LAP-30, OBE-42
Periodontal ENT-94
Rectal REC-4
Sinus ENT-94-95
Spinal OBE-42

PROCLEAN

Tip Cleaning Pad ENT-33

PROVIDENCE HOSPITAL

Hemostatic Forceps CVT-88, GEN-57, PED-13
Mosquito Forceps GEN-67

PUNCHES

Adenoid ENT-95-96
Antrum ENT-97-98
Arthroscopic O/S-71-75
Biopsy LAP-54, OBGYN-32
Dermal GEN-176
Micropunch O/A-75
Pediatric Antrum PED-21
Putti Bone Rasp O/A-76
Sinus ENT-95
Sinus & Nasal ENT-97-100, ENT-102-105
Skull NEU-63
Sphenoid ENT-100
Stella NEU-63
Sternal CVT-136
Uterine OBGYN-32-33

PUSHERS

Suture NEU-64

PUTTI

Bone Rasp SPN-96

Q

QUAD-LOCK® SS-4-9

QUICK KIT SS-31-32

QUICKERT

Lacrimal Intubation Probe OPH-45

R**RAGNELL**

Retractor ENT-109, GEN-231, RET-55
Scissors ENT-131

RAGNELL KILNER

Micro-Serrated Razor Edge Scissors GEN-280

RAGNESS

Dissecting Scissors ENT-137

RAIMONDI

Scalp Forceps GEN-105, NEU-37, PED-15

RALKS (VIRTUS)

Splinter Forceps GEN-69

RANDALL

Endometrium Biopsy Suction Curette OBGYN-6
Kidney Stone Forceps GEN-64, URO-5

RANDOLPH

Cyclodialysis Cannula OPH-7

RANEY

Laminectomy Rongeur SPN-178
Perforator Drill NEU-21

RANEY-CRUTCHFIELD

Skull Tongs NEU-123

RANKIN

Hemostatic Forceps CVT-88, GEN-57

RAPIDCLEAN®

Cervical Rongeurs SPN-175
Glide Lock Devices LAP-2-3
Handles LAP-75, LAP-84
Laparoscopic Forceps LAP-75-90
Lumbar Rongeurs SPN-181-182
Outer Shaft LAP-75
Outer Sheath LAP-87
Rongeurs NEU-102
Sterilization Tray SPN-187

RASPATORIES/RASPS CVT-137, GEN-177

Bone NEU-64, SPN-96
Bone & Skin ENT-100
Middle Ear ENT-101
Nail O/A-77
Nasal ENT-101-105
Rib PED-22

RAY

Pituitary Curette NEU-10

REAMERS

Intramedullary O/A-77

RECAMIER

Placenta Curette OBGYN-6

RECTAL SNARE ENG-34

REDUCER SLEEVES LAP-27

REINER

Bone Rongeur..... NEU-86, O/A-100-101
Rongeur NEU-86, SPN-140

REIHNOFF-FINOCHIETTO

Rib Spreader CVT-219

RESANO

Titanium Vascular Tissue Forceps..... GEN-105

RETRACTOR BLADES

See also BALFOUR BLADES; BOOKWALTER® BLADES;
BOOKWALTER®-MEYERDING; BOOKWALTER®-
MAGRINA; UNIVERSAL RING BLADES.....

CVT-139, ENT-115, OBE-52, OBGYN-34, PED-22,
PED-28, RET-60, SPN-109-111

ACF SPN-129

Cervical..... RET-113-116, SPN-108, SPN-127-128,
SPN-132

Charnley RET-93

Crank Frame SPN-110

Crank Frame Blade..... SPN-116

Crockard NEU-67

Greenberg® NEU-74, RET-82

Henly Retractor Blade..... RET-62

Hook Blade SPN-124-125

with Lip..... SPN-110

Narrow Muscle SPN-126

Radiolucent..... SPN-132

Tongue NEU-68, RET-111

Ultra™ SPN-108-109

Universal Ring..... CVT-156-159, GEN-206, RET-28

Wide Muscle SPN-127-128

RETRACTOR CASES

See also BOOKWALTER® CASES..... CVT-55

Crockard NEU-68

RETRACTOR SYSTEMS

See also BOOKWALTER® SYSTEMS

Cervical..... SPN-101-107

Components SPN-108-111, SPN-116, SPN-130

Crank Frame Spinal Retractor SPN-115

Ultra™ ReVeal Basic View SPN-100

RETRACTORS

See also BALFOUR BLADES; BALFOUR RETRACTORS;
BOOKWALTER® BLADES; BOOKWALTER®
RETRACTORS; WEITLANER

Abdominal.. CVT-156-160, GEN-177-184, GEN-228,
OBE-51, OBE-66, OBGYN-33, PED-29, RET-2-31,
RET-43-61

Abdominal (Vision)..... GEN-203

Alar ENT-114, ENT-115

Anal REC-5

Anterior Cervical Fusion Kkits..... RET-138

Aorta..... CVT-138

Aortic Valve..... CVT-138

Appendectomy CVT-138, GEN-232, RET-32

Atrial Valve..... CVT-139

Bariatric..... GEN-221

Capsule..... RET-89

Cardiac..... RET-32-35

Carotid..... CVT-164, CVT-172, RET-36

Cerebellar GEN-213, GEN-245, NEU-64, RET-37,
RET-39

Cervical..... PED-28, RET-112, RET-116-117, SPN-109,
SPN-113-115

Cheek..... ENT-106, RET-37

Cheek & Tongue..... ENT-118

Cobra..... OBE-45 RET-89, RET-90

Crockard NEU-65-69

Decompression GEN-218, NEU-69, SPN-116

Deltoid..... RET-38

Dural PED-23, RET-117-118, SPN-117

Dural Suction..... GEN-222, GEN-242

Endaural..... ENT-110, GEN-247, RET-38

ENT RET-39-40

Epicardial (I.M.A.)..... CVT-164, GEN-213, PED-23

Fan LAP-22, LAP-24, RET-72

Fiber Optic..... RET-40-41, RET-62

Finger..... GEN-215

Flap RET-75

Flexible Neck..... ENT-115, GEN-215, RET-49

Four Prong CVT-165

Frame OBGYN-34

Gall Bladder GEN-214, RET-41

General Purpose..... OBE-43-46, RET-42-67,
SPN-97-100, SPN-129

Glenoid O/A-88

Greenberg® NEU-70-76

Hand GEN-230, O/A-89

Hand-Held..... ENT-106-108, GEN-215-236,
NEU-77, PED-24, RET-43-61, RET-76, RET-85-86,
RET-119-120

Hard Palate..... NEU-66, SPN-118

Hemilaminectomy . GEN-245, RET-121, SPN-118-119

Hip..... O/A-51, O/A-89, RET-94

Hook..... ENT-110, LAP-27

Horizontal RET-65

Humeral Head Retractor RET-95

Hysterectomy OBGYN-39, RET-71-72

Iris OPH-47

Knee O/A-52, O/A-89-91

Lacrimal Sac GEN-234, OPH-47
Lamina/Laminectomy
GEN-229, GEN-241, GEN-243, GEN-246-247,
OBE-65, PED-25, RET-121-124, SPN-119-121

Laparoscopic GEN-209-212, RET-72-73

Laryngeal ENT-112

Leyla..... NEU-78-79

Lid OPH-46-47

Lighted RET-62

Lip NEU-136

Lumbar SPN-122

Lung..... CVT-166, GEN-214, RET-74

Mastectomy..... RET-74

Mastoid GEN-244

McCulloch..... SPN-123-128

Medial SPN-128

Micro SPN-129

Micro Discectomy..... RET-71, RET-126, SPN-129

Microsurgical NEU-84

Microvascular..... CVT-172, GEN-245, PED-26

Middle Ear ENT-110-111

Mid-Facial Osteotome NEU-66

Mini O/A-91

Mini Thoracotomy CVT-166

Multi-Purpose Peripheral Vascular..... CVT-167

Nasal. *See also* Sinus & Nasal..... ENT-111-112

- Nerve Root GEN-217, GEN-221-222, GEN-228, GEN-237, PED-25, RET-132-135, SPN-130-131
- Neuro RET-75-77, RET-79-85
- Obstetric OBE-66
- Ophthalmologic OPH-46-47, RET-85-88
- Orbital ENT-112, OPH-47
- Orthopaedic RET-89-97
- Osteotomy RET-110
- PCL O/A-91
- Pediatric PED-22-30, RET-21, RET-43, RET-69
- Pelvic O/A-85, RET-55, RET-60
- Perineal GEN-244, OBGYN-39, RET-62
- Pharyngeal NEU-67, RET-110-111, SPN-132
- Pillar ENT-112
- Plastic Surgery RET-97-98
- Popliteal CVT-167, RET-63
- Posterior Fossa RET-77
- Prostatic REC-5, RET-98
- Pyloric Stenosis GEN-237
- Radiolucent SPN-132
- Rake RET-49-50, RET-53, RET-55
- Ratchets RET-22-24
- Rectal OBE-65, REC-5-6, RET-99-101
- Redundant Wall RET-101
- Renal GEN-238, RET-102
- Renal Sinus GEN-238
- Rib CVT-168-169, PED-26-27, RET-103-106
- Ribbon CVT-170, GEN-231, OBE-50, RET-55-56, SPN-99
- Rings RET-24-26
- "S" LAP-25, OBE-37, RET-72
- Sacral SPN-133
- Scalp ENT-112, GEN-238--240, GEN-243-245, NEU-81-82, PED-27, RET-105-107
- Scapula CVT-171, GEN-219, PED-27-28, RET-107
- Self-Retaining CVT-171-173, ENT-113-114, GEN-239-248, NEU-83, O/A-92-93, PED-28-29, RET-36, RET-62-67, RET-78, RET-88, SPN-133-134
- Septum RET-108
- Side Loading RET-74
- Sinus & Nasal ENT-115
- Skin PED-26
- Soft Tissue O/A-94
- Spinal RET-108-143, SPN-134
- Splanchnic CVT-174, GEN-224
- Spring ENT-113, GEN-249, O/A-92, PED-30, RET-65, RET-67
- Sternal CVT-165, CVT-174-177, PED-24-25, PED-30, RET-144-146, SPN-135
- Thoracotomy RET-146
- Thymus ENT-116
- Thyroid ENT-116, GEN-223, GEN-228, GEN-250, OBE-66, RET-147-148
- Tissue CVT-177, GEN-246, RET-67
- Tongue SPN-135
- Tonsil ENT-112, RET-148
- Tracheal ENT-107, ENT-109-110, GEN-129-131, GEN-250, RET-149
- Transoral NEU-69, RET-108-112
- Transoral Instrument Set NEU-65-69
- Transsphenoidal NEU-83
- Universal OBGYN-40
- Universal Ring GEN-204-205
- Uvula ENT-117, RET-150
- Vaginal OBE-67, OBGYN-40-41, OBGYN-51, RET-151-156
- Vagotomy GEN-250
- Vascular CVT-177, RET-157-158
- Vascular Spring CVT-178
- Vein ENT-117, GEN-219, GEN-251, NEU-84, OBE-67, RET-159
- Vein Holder CVT-178-183
- Vessel Supporter NEU-84
- Vision CVT-156, CVT-184-186, GEN-207-209, RET-31
- Wing Nuts OBGYN-34, RET-6
- REUL**
- Aorta Clamp CVT-13
- Coronary Forceps CVT-77
- Coronary Artery Scissors CVT-191
- REVERDIN**
- Needle GEN-172
- REYNOLDS**
- Dissecting Scissors GEN-280, OPH-59
- Scissors GEN-296
- Vascular Clamps CVT-49
- RHODE ISLAND HOSPITAL**
- Instrument Holder CVT-221, GEN-312, SS-46
- RHOTON®**
- Ball Dissector NEU-11
- Bayonet Bipolar Forceps ENG-17, ENG-19, GEN-39-40
- Bipolar Forceps GEN-36
- Dressing Forceps CVT-82, GEN-49, NEU-32
- Dural Forceps GEN-105, NEU-33
- Elevator NEU-27
- Forceps GEN-105, NEU-43
- General Purpose Elevator GEN-22, NEU-22
- Hook NEU-53
- Micro Bayonet Scissors NEU-116
- Micro Cup Forceps NEU-35, PED-14
- Micro Dissector Set NEU-16
- Needle Holder GEN-149-150, NEU-58
- Nerve Hook NEU-49, OBE-36, SPN-69
- Neuro Suction Tube NEU-129
- Scissors NEU-119-120
- Spatula Dissector NEU-17
- Sterilizing-Carrying Case SS-43
- Straight Point Needle NEU-61
- Suction Tube GEN-324
- Tumor Forceps GEN-106, NEU-40
- RHOTON®-MERZ**
- Suction Tube NEU-133
- RIB SPREADERS**
- Sternal PED-30
- Neonatal CVT-186
- RICHARDSON**
- Appendectomy Retractor GEN-232
- Retractor Blade (Bookwalter®) CVT-141, GEN-188, RET-11
- Retractor Blade Kit (Bookwalter®) CVT-149, GEN-195
- Retractors CVT-138, CVT-182, GEN-232-233,

- O/A-85, OBE-50, RET-20, RET-32, RET-56-57
- RICHARDSON-EASTMAN**
Retractor..... CVT-182, GEN-233, O/A-86, RET-57
- RIGBY**
Appendectomy Retractor..... RET-32
- RING CUTTERS**..... GEN-251
- RINGS**
Laparotomy GEN-251
OphthalmologicOPH-48
- RISTOW**
Osteotome..... ENT-87
- RIZZUTI**
Expressor & Iris Retractor OPH-47
- ROBERTS**
Biopsy Forceps ENT-45
Episiotomy ScissorsGEN-282, OBGYN-42
- ROCHESTER-CARMALT**
Forceps..... CVT-119
Hemostatic Forceps.....GEN-57, GEN-58, OBE-27
- ROCHESTER-MIXTER**
Artery Forceps..... CVT-75, GEN-29
- ROCHESTER-OCHSNER**
Bariatric Forceps CVT-76
Forceps.....CVT-120, GEN-58, GEN-60, OBE-27
Hemostatic Forceps.....CVT-88, GEN-58-60
- ROCHESTER-PEAN**
Baby Artery Forceps..... GEN-29
Forceps.....CVT-120, GEN-59, OBE-27, PED-13
Hemostatic Forceps..... CVT-88
Thoracic Forceps.....CVT-98
- ROEDER**
Loop Applicator..... LAP-28
Towel Clamp GEN-14
- ROGERS**
Classic Plus® Needle Holders.....CVT-132, GEN-166
Elevator ENT-29
Hysterectomy Forceps..... GEN-8, OBGYN-18
- ROLLET**
Lacrimal Sac Retractor ... GEN-234, OPH-47, RET-76
- RONGEURS**
See also FORCEPS
Aortic..... CVT-187
Arthroscopic O/A-94
Bayonet NEU-97
Bayonet Micro-Dissector SPN-165
Bone..... ENT-118-119, NEU-85-87, NEU-105-107,
NEU-109, O/A-94-104, SPN-136-142
Bone Cutting..... PED-32
Bone Cutting Forceps CVT-187
Bone, Synovectomy..... SPN-142
Cement Removal O/A-105
Cervical.....NEU-88-103, SPN-172-175
ConvertibleSPN-162-163
- Cranial SPN-136
Dissectomy..... NEU-104, SPN-152
Duck Bill Bone..... CVT-188
Duckbill SPN-137
Ejector.... SPN-155-156, SPN-163-164, SPN-179-180
First Rib..... CVT-188
General Purpose..... OBE-67-73
Intervertebral Disc..... NEU-91,
NEU-94-97, NEU-101-102, OBE-68--70,
PED-31-32, SPN-143-155
Kerrison ENT-119, SPN-155-184
Laminectomy ..NEU-106-107, OBE-68, PED-31-32,
SPN-137-138, SPN-141, SPN-176-178
Lumbar OBE-69, SPN-160-161
Micro.....NEU-88-90, NEU-97-101, NEU-108,
SPN-137, SPN-155-159, SPN-162-170, SPN-182
Mini O/A-105
Pituitary.....NEU-91, SPN-178
Rib OBE-70
Spurling.....SPN-152-155
Synovectomy ENT-120-122, O/A-105
- RONIS**
Adenoid Punch ENT-96
- ROSEN**
Cartilage Knife.....ENT-74
Knife Curette ENT-16
Pick ENT-92
Suction Tubes ENT-146, GEN-324
- ROTATORS**
Ophthalmologic OPH-49
- ROUX**
Retractor..... GEN-234, O/A-86, RET-57
- ROWE**
Maxillary Disimpaction Forceps..... ENT-51
- RUBIN**
Osteotome..... ENT-87
- RUBIO**
Classic Plus® Needle Holders.....CVT-132, GEN-166
Classic® Wire Holder Clamp CVT-43, GEN-17, PED-6
Wire Twister GEN-150, O/A-112, SPN-195
- RUEDEMANN**
Lacrimal Dilator OPH-10
- RULERS**..... GEN-252, OBGYN-42
- RUMEL**
Cardiovascular Tourniquets.....CVT-225
Dissecting Artery Forceps..... CVT-78, GEN-43
Obturator.....CVT-135, PED-49
- RUSKIN**
Bone Cutting ForcepsNEU-30, O/A-35, SPN-59
Bone Rongeurs..... CVT-187, ENT-119, O/A-101-102
Mini Rongeur O/A-105
RongeurNEU-87, SPN-140
- RUSKIN-ROWLAND**
Bone Forceps O/A-35
- RUSSEL-DAVIS**
Tongue Blade..... ENT-82

RUSSIAN

Tissue Forceps.....CVT-110, GEN-83, GEN-106,
OBE-32-33, PED-48

RYDER

Classic Plus® Needle Holder CVT-132-133, GEN-168,
OBE-39, PED-20
Intracardiac Needle Holder GEN-160
Needle Holders.....CVT-132, GEN-167
Titanium Needle Holder..... GEN-150

S**SACHS**

Suction Tubes GEN-325, NEU-133, OBE-80

SAGE

Tonsil Snare..... ENT-138

SALZ

Titanium Lens Cracker..... OPH-35

SANDERS

Vasectomy Forceps.....GEN-123

SANGER

Placenta and Ovum Forceps OBGYN-23

SARNS

Suction Tube..... GEN-326

SAROT

Artery Forceps..... CVT-72, CVT-75, GEN-26
Bronchus Clamp CVT-18, GEN-41
Classic Plus® Needle Holders CVT-133
Needle Holders..... GEN-169

SATINSKY

Opti-Length® Forceps.....CVT-94
Scissors CVT-215
Vena Cava Clamps..... CVT-49-50

SAUER

Speculum..... OPH-72
Suture Forceps GEN-74, OPH-23

SAUERBRUCH

Retractor GEN-234, O/A-86, RET-58
Rib Shears CVT-217, OBE-78

SAUERBRUCH-STILLE

Bone Rongeur O/A-102

SAUNDERS

Instrument Holder.....CVT-62

SAUNDERS-PAPARELLA

Needle.....ENT-84
Stapes Hook.....ENT-67

SAWS

Guides NEU-110
Handles.....NEU-110-111
NasalENT-123
Sternum..... CVT-188
Wire.....NEU-112-113

SAWTELL

Forceps..... GEN-106

SAWYER

Rectal RetractorOBE-65, REC-6, RET-101

SAYE/REDDICK

Knot Pusher..... LAP-28
Needle Holder..... LAP-28

SAYRE

Periosteal Elevator O/A-28, SPN-57

SCHAFF

Foreign Body Forceps OPH-23

SCHAUMBERG

Comedone Extractor GEN-26

SCHIEER

Crimper Forceps.....ENT-46

SCHIEIE

Anterior Chamber Cannula..... OPH-7
Aspirating Cataract Needle OPH-40

SCHEPENS

Orbital Retractor..... OPH-47, RET-87
Scleral Depressor OPH-9

SCHLESINGER

Cervical Laminectomy Rongeur PED-31
Intervertebral Disc Rongeur NEU-102, SPN-151

SCHNIDT

Forceps..... CVT-120, GEN-106, GEN-116, OBE-23
Hemostatic Forceps..... GEN-59, OBE-27

SCHOCKET

Scleral Depressor OPH-9

SCHOENBORN

Retractor..... GEN-234, RET-58

SCHROEDER

Uterine Tenaculum Forceps..... GEN-118, OBGYN-24
Vulsellum Forceps GEN-118, OBGYN-24, OBGYN-27

SCHUBERT

Uterine Biopsy Forceps OBGYN-24

SCHUKNECHT

Anterior Foot Plate Hook.....ENT-66
Posterior Foot Plate HookENT-66
Retractor.....ENT-111, RET-67
Roller Knife ENT-76
Sickle Knife ENT-77
Stapes Hook.....ENT-67
Stapes Needle.....ENT-84
Suction Tube..... GEN-326
Wire Cutting Scissors..... GEN-308

SCISSORS

Abdominal..... CVT-193-194, GEN-252
Alligator.....ENT-123-124, NEU-118
Angled GEN-253, OPH-66
Arteriotomy CVT-208
Artery CVT-188, GEN-253-254
Arthroscopic O/A-106
Bandage CVT-189, GEN-254-255

- Bandage & Plastic GEN-255
 Bayonet NEU-113
 Calcified Tissue CVT-189
 Capsulotomy OPH-53, OPH-65
 Cardiovascular CVT-189
 Cartilage O/A-106
 Ceramic Coated GEN-257,
 GEN-260-261, GEN-267, GEN-270-272, GEN-276,
 GEN-285, GEN-298, GEN-303-304, GEN-306,
 OPH-57-58
 Circumflex CVT-190
 Conjunctival OPH-65
 Corneal OPH-50-52, OPH-56, OPH-64, PED-33
 Coronary CVT-190
 Coronary Artery CVT-190-191
 Crown & Collar GEN-256
 Delicate CVT-192-193, CVT-203, GEN-256-257,
 GEN-259, PED-33
 Dissecting CVT-192-197,
 ENT-124, ENT-137, GEN-258-281, OBE-75-77,
 OPH-53, OPH-57, OPH-59, PED-33-34
 Dorsal ENT-125-126
 Dual Purpose PED-8
 Dural GEN-281, NEU-114, PED-34
 Endarterectomy CVT-198
 Endo LAP-72
 Enucleation GEN-281, OPH-53
 Episiotomy GEN-282, OBGYN-42-43
 Eye GEN-282
 Face Lift ENT-127
 Fine CVT-199, PED-35
 Fine Vascular CVT-199
 Ganglion ENT-127, GEN-283, NEU-114
 General Purpose .. CVT-198, ENT-137, NEU-119-120,
 OBE-71-77
 Gynecology GEN-283
 I.M.A CVT-199
 Iris GEN-284-287, OPH-50, OPH-54-59,
 OPH-62-63, PED-35-36
 Keratoplasty OPH-52
 Laparoscopic ENG-42, ENG-44,
 LAP-41-43, LAP-48, LAP-57, LAP-61, LAP-64-65,
 LAP-71-72, LAP-82
 Leaflet CVT-200
 Lobectomy CVT-200
 Lower Lateral ENT-128
 MagnaFree® CVT-200
 Micro CVT-200-201, CVT-204, GEN-287-289, NEU-115,
 NEU-117, OBGYN-43, OPH-52, OPH-58, PED-36
 Micro Bayonet NEU-116, NEU-118
 Micro-Laryngeal ENT-128-129
 Micro Pituitary NEU-117
 Micro-Serrated GEN-258
 Micro Vascular CVT-201, CVT-214, GEN-305,
 GEN-307
 Microsurgical CVT-202-203, PED-36
 Miniature ENT-129
 Mitral Valve CVT-202, GEN-304
 Modified Circumflex CVT-202
 Moleskin GEN-289
 Nasal ENT-130-131
 with Needle Holder CVT-131
 Neuro GEN-290-291
 Neurosurgical NEU-117-118, NEU-120
 Obstetrics/Gynecology OBGYN-44
 Operating. CVT-203-204, GEN-278, GEN-291-294,
 PED-37-38
 Ophthalmologic OPH-50-66
 Peripheral Vascular CVT-213
 Pituitary PED-38
 Razor Edge CVT-204, ENT-131, ENT-134,
 GEN-257, GEN-261-262, GEN-268, GEN-270,
 GEN-272, GEN-276, GEN-279-280, GEN-286-287,
 GEN-294, GEN-296-297, GEN-300, GEN-306,
 OPH-58-59, OPH-62-63
 Removal ENT-132
 Reposable LAP 25-27
 Rhinoplasty ENT-132
 Septum ENT-132
 Serrated ENT-133-134, GEN-260, GEN-262, GEN-266-268,
 GEN-270, GEN-272, GEN-275-277, GEN-279-280,
 GEN-286-287, GEN-298, GEN-300, GEN-306,
 OPH-59, OPH-63
 Shortbent CVT-205
 Sinus ENT-133, PED-38
 Stitch CVT-205-206, GEN-294-295, OPH-56,
 OPH-61-62, OPH-66, PED-39
 Strabismus GEN-299, OPH-57, OPH-62, PED-40
 Suture CVT-206, CVT-215-216, GEN-307-308
 Suture Carrying ENT-133
 Suture Wire GEN-296
 Tenotomy ENT-134,
 GEN-261, GEN-296-301, GEN-306, OPH-58-60,
 OPH-63, OPH-66, PED-40-41
 Thoracic CVT-206
 Tissue GEN-301
 Tissue & Gum ENT-135, GEN-302
 Titanium PED-36
 Tonsil ENT-135
 Trigeminal GEN-258
 Turbinate ENT-136
 Umbilical GEN-302, OBGYN-43-44
 Uterine GEN-302, OBGYN-44
 Utility GEN-303, OPH-65, OPH-66
 Valve CVT-207, OBE-72, OBE-77
 Vascular CVT-207-215, GEN-303-307, PED-41
 Wire Cutting CVT-215-216, GEN-307-308
 Wire Suture PED-42
- SCOOPS**
 Common Duct GEN-308
 Gall Stone GEN-309
 Pituitary NEU-121
- SCOPEPAK**
 Accessories SS-34
 Cases LAP-32, SS-33
 Base & Lid LAP-33, SS-33
- SCOVILLE**
 Brain Spatula GEN-310, NEU-125
 Curette OBE-10, SPN-37
 Hemilaminectomy Retractor SPN-118
 Hook NEU-50, NEU-53, SPN-67
 Hook (Bookwalter®) GEN-188
 Hook with Bar SPN-99
 Nerve Hook NEU-50

- Nerve Root Retractor GEN-237, SPN-131
 Retractor Blade SPN-111
 Retractors.....PED-25, RET-11, RET-30, RET-134
 Spinal Disc Curette..... OBE-11
 Ultra™ Reveal Lumbar Retractor Body SPN-122
- SCOVILLE-GREENWOOD**
 Bayonet Bipolar Forceps ENG-18, ENT-38, GEN-40
- SCOVILLE-HAVERFIELD**
 Hemilaminectomy Retractor Body SPN-118
- SCREWS**
 Distraction..... SPN-185
- SECTO®**
 Dissectors.....NEU-11, NEU-12
 Laparoscopic Dissectors..... LAP-32
 Peanut Dissector NEU-14
 Tonsil Sponges..... ENT-86, GEN-310, NEU-126
 Triangle Dissector..... NEU-15
- SEDILLOT**
 Periosteal Elevator O/A-28, SPN-57
- SEEBURGER**
 Retractor.....GEN-235, RET-67
- SELLER**
 Turbinate Scissors..... ENT-136
- SELDIN**
 Periosteal Elevator ENT-25
- SELETZ-GELPI**
 Laminectomy Retractor GEN-247, RET-124,
 SPN-121
- SELMAN**
 Peripheral Blood Vessel Clamp CVT-40
 Tissue Forceps..... GEN-107
- SELMAN-COOLEY**
 Peripheral Vascular Clamp CVT-41
- SELVERSTONE**
 Intervertebral Disc Rongeur NEU-102, PED-31,
 SPN-151
- SEMB**
 Ligature Carrying Forceps CVT-90, GEN-64,
 OBE-28
 Lung Retractor CVT-166
 Raspatory CVT-137
- SEMBSTILLE**
 Rongeur O/A-102, SPN-141
- SEMKEN**
 Bipolar Forceps ...ENG-11, ENG-25, ENT-38, ENT-42
 Dressing Forceps CVT-82, GEN-49, NEU-32
 Tissue Forceps..... GEN-107, NEU-39, PED-48
- SEMMES**
 Spinal Fusion Curette..... SPN-25
- SENN**
 Retractor CVT-183, ENT-109, GEN-235, O/A-86,
 RET-58, SPN-99
- SENNING**
 Bulldog Clamp..... CVT-22
- SEPARATORS**
 Dural NEU-121-122
 Packer..... NEU-122
- SEWALL**
 Orbital Retractor..... ENT-112, RET-88
- SHAMBAUGH-DERLACKI**
 Needle..... ENT-83
- SHAPLEIGH**
 Ear Curette..... ENT-12
- SHARP**
 Elevator NEU-25
 Periosteal Elevator SPN-57
- SHEA**
 Ear Speculum Holder ENT-138
 Foot Plate Hook ENT-67
 Oblique Hook..... ENT-66
 Pick ENT-89
 Prosthesis Placement Instrument..... ENT-71
- SHEA-BELLUCCI**
 Scissors ENT-129
- SHEARS**
 Rib..... CVT-216-217, OBE-77-78
- SHEEHAN**
 Osteotome..... O/S-68, SPN-92
- SHEEHY**
 Fascia Press..... ENT-93
 Ossicle Holding Clamp..... ENT-7
- SHEETS**
 Iris Hook..... OPH-33
- SHEETS-MCPHERSON**
 Tying Forceps OPH-23
- SHEPHERD-WESTCOTT**
 Tenotomy Scissors..... OPH-60
- SHIELDS**
 Anesthesia Circuit ENG-64, ENT-31
 Eye ENG-65, ENT-32, OPH-67
 Personnel..... ENG-65, ENT-32
- SHUTT**
 Tray..... O/A-12
- SHUTTLES**
 Arthroscopic O/A-107
- SILVER**
 Osteotome ENT-88
- SIMCOE**
 Cortex Extractor OPH-10
 Lens Loop OPH-36
- SIMPSON**
 Obstetrical Forceps..... OBGYN-22
 Uterine Sound..... OBGYN-45

SIMS

Operating Scissors..... GEN-294
 Rectal Speculum..... REC-9
 Uterine Curette..... OBGYN-8
 Uterine Scissors..... GEN-302
 Uterine Sound..... OBGYN-45
 Vaginal Retractor..... OBGYN-41, RET-156
 Vaginal Speculum..... OBGYN-52

SINGLEY

Intestinal Forceps..... CVT-90, GEN-108

SINGLEY TUTTLE

Intestinal Forceps..... OBE-26

SINSKEY

Iris Lens Manipulating Hook..... OPH-32
 Tying Forceps..... OPH-23

SINSKEY II

Lens Manipulating Hook..... OPH-32

SISSON

Nerve Hook..... NEU-50

SKENE

Tenaculum Forceps..... OBGYN-54

SKIDS

Bone..... O/A-107
 Hip & Shoulder..... O/A-107
 Lever..... O/A-108

SKILLERN

Sinus Probe..... ENT-95

SKILLMAN PACKER

Mosquito Forceps..... GEN-67

SKINNER

Needle Forceps..... GEN-108

SKULL TONGS..... NEU-122-123**SLUDER JANSEN/SCHINK**

Mouth Gag..... ENT-82, RET-75

SMILLIE

Knee Retractor..... O/A-90-91, RET-96

SMITH

Nerve Root Retractor..... RET-135
 Nerve Root Suction Retractor..... SPN-131

SMITH-BUIE

Rectal Retractor..... REC-6, RET-101

SMITH-PETERSON

Bone Gouge..... O/A-45, SPN-65-66
 Laminectomy Rongeur..... NEU-107, SPN-141
 Mallet..... SPN-85
 Osteotome..... O/S-69, SPN-93-94
 Rongeur..... O/A-103

SMITHWICK

Neck Hook-Dissector..... CVT-70, GEN-125, NEU-13,
 OBE-36

SNARES

Nasal..... ENT-138
 Tonsil..... ENT-138

Wire..... ENT-138

SNITMAN

Endaural Retractor..... GEN-247, RET-38

SOFIELD

Retractors..... O/A-87, RET-59, RET-120

SOMERS

Uterine Forceps..... OBGYN-25

SOUNDS

Urethral..... PED-42, URO-6-7
 Uterine..... OBGYN-45

SPATULAS**GEN-309-310**

Brain..... GEN-309-310, NEU-123-125
 Elevator..... OBE-78
 Endarterectomy..... CVT-218
 Nerve..... NEU-125
 Ophthalmologic..... OPH-67-68

SPECIALTY TRAYS..... SS-37-44**SPECULUMS**

Endocervical..... OBGYN-45
 Eye..... PED-43
 Lumbar..... RET-124
 Middle Ear..... ENT-138
 Nasal..... ENT-138-139, RET-40
 Nasal Bivalve..... NEU-137
 Newborn..... OPH-69
 Operating..... REC-7
 Ophthalmologic..... OPH-69-72, RET-86, RET-88
 Rectal..... REC-7-9
 Septum..... ENT-140-143, RET-108
 Temporal Wire..... OPH-72
 Transsphenoidal..... NEU-125
 Vaginal..... ENG-64, OBGYN-46-52

SPENCE

Intervertebral Disc Rongeur..... SPN-152

SPENCER

Needle Holder..... GEN-169
 Stitch Scissors..... CVT-205, GEN-295, PED-39

SPETZLER

Neurovascular Dissector..... NEU-14
 Neurovascular Forceps..... GEN-108, NEU-36
 Neurovascular Needle Holder..... NEU-59
 Neurovascular Scissors..... GEN-291, NEU-118

SPLITTERS

Cement..... O/A-108

SPONGES..... ENT-86

Tonsil..... GEN-310, NEU-126

SPOONS..... OBGYN-53

with Brain Spatula..... NEU-123
 Ear..... ENT-12
 Ophthalmologic..... OPH-72
 Pituitary..... NEU-126, NEU-137
 Transsphenoidal..... NEU-126

SPRAGUE

Ear Curette..... ENT-12

- SPRATT**
Bone Curette SPN-14
- SPREADERS**
Lamina OBE-79, SPN-185-186
Middle Ear ENT-145
Pediatric Rib CVT-218
Rib CVT-219-220
Vertebral SPN-185, SPN-187
- SPUDS**
Foreign Body OPH-73
Ophthalmologic OPH-73
- SPURLING**
Intervertebral Disc Rongeur NEU-102, OBE-69,
PED-32, SPN-152-155
- SPURLING KERRISON**
Rongeur NEU-91, NEU-103-104, NEU-107,
SPN-182-184
- ST. CLAIR**
Adenoid Forceps ENT-63
- ST. MARKS**
Retractors RET-59-60
- STACKPAK** SS-35
- STAGBEE**
Bone Reduction Forceps O/A-38
- STECHER**
Arachnoid Knife NEU-54
- STEINER-AUVARD**
Vaginal Speculum OBGYN-46
- STERILIZATION**
Accessories SS-9, SS-16, SS-26, SS-28, SS-34
Containers LAP-94-95, RET-82
Racks CVT-222
Trays CVT-60, SPN-187
- STERNAL**
Classic Plus® Needle Holders & Wire Twister CVT-133
- STERN-CASTROVIEJO**
Forceps GEN-108, OPH-23
- STERN-GILLS**
Scissors OPH-60
- STERRAD**
Base & Lid LAP-94
- STEVENS**
Scissors OPH-58-61, OPH-63-64, PED-41
Tenotomy Hook OPH-33
Tenotomy Scissors ENT-134, GEN-297-298,
GEN-300-301
- STEVENSON**
Lacrimal Sac Retractor OPH-47, RET-76
- STEWART**
Crypt Hook REC-2
- STILLE**
Chisel O/A-6, SPN-7
Duckbill Bone Rongeur CVT-188
Gouge O/A-45, SPN-66
Osteotome SPN-94
- STILLE GIERTZ**
Rib Shears CVT-217, OBE-78
- STILLE-LISTON**
Bone Cutting Forceps NEU-30
Bone Forceps O/A-35, OBE-24, SPN-60
- STILLE-LUER**
Bone Rongeur O/A-103, SPN-60
Rongeur CVT-187, OBE-68, OBE-71, NEU-87,
SPN-141-142
- STONEY**
Spleno-Reno Shunt Clamp CVT-43
- STOOKEY**
Cranial Rongeur NEU-105
- STRATTE**
Classic Plus® Needle Holder CVT-134
Needle Holders GEN-170
- STRINGERS (INSTRUMENT HOLDERS)**
CVT-60-62, CVT-220-222, GEN-310-313, SS-45
- STRIPPERS**
Disposable Vein Stripper CVT-222
Endarterectomy CVT-222
Vein Holder CVT-222
- STRONG**
Aorta Clamp CVT-13
- STRUEMPFL**
Ear Forceps ENT-49
- STRULLY**
Neurological Scissors GEN-291, NEU-118
- STRULLY GIGLI**
Saw Handles NEU-111
- STRYUCKEN**
Turbinate Forceps ENT-63
- STUBBS**
Adenoid Curette ENT-10
- SUBRAMANIAN**
Mini Aorta Clamp CVT-13
- SUCTION COAGULATORS** ENG-57
- SUCTION TUBES**
Aspirating ENT-146-157
Dural SPN-189
Ear ENT-145-146
General Purpose CVT-223-224, GEN-314-328,
NEU-129-133, OBE-79-81
Holders CVT-224, NEU-68, SPN-190
Liposuction GEN-314
Midde Ear ENT-145-146
Pediatric PED-43-44
Sump CVT-223, CVT-225
Tear-Drop GEN-320-321, GEN-326-327
Tube OBE-81

- Vascular.....CVT-224-225, GEN-327, OBE-81
- SUNDT**
Clip Trays.....SS-44
- SURG-I-BAND**
Instrument Marking Tape.....SS-46
- SURGI-SHEAR**
2-piece Scissors.....LAP-82
- SWANSTROM**
Grasping Forceps.....LAP-73
- SWEDEN**
Needle Holder.....GEN-170
- SWEET**
Pituitary Scissors.....NEU-118, PED-38
Sternal Punch.....CVT-136
- SYMMETRY**
Instrument Case.....SS-44
Instrument Lubricant.....SS-47
Micro Instrument Kit.....NEU-128
- SYPERT**
Tamp.....O/A-109, SPN-190
- SYRINGES**
Ear.....ENT-148
- T**
-
- TABB**
Elevator.....ENT-24
Flap Knife.....ENT-74
Myringoplasty Knife.....ENT-75
- TAKAHASHI**
Nasal Forceps.....ENT-56
- TAMPS** **SPN-190**
ACF.....SPN-190
Bone.....O/A-109, SPN-191
- TAPP**
Pick Knife.....ENT-76
- TAPS**.....O/A-110
- TAYLOR**
Dural Scissors.....GEN-291, NEU-114, PED-34
Laminectomy Blade.....SPN-122
Percussion Hammer.....GEN-124, NEU-56
Spinal Retractor.....RET-120, SPN-134
- TEALE**
Uterine Vulsellum Forceps.....GEN-118, OBGYN-25
- TEBBETTS**
Forceps.....GEN-75
Retractor.....RET-41
Septal Elevator.....ENT-26
Speculum.....ENT-140
- TEBBETTS-BROWN**
Forceps.....GEN-109
- TENACULUMS** **OBGYN-53-55**
Hook.....OBGYN-53
Inserts.....LAP-2
Laparoscopic.....LAP-16, LAP-21
Tracheal.....ENT-107
- TENNANT**
Nucleus Manipulator.....OPH-38
Tying Forceps.....OHP-25
- TENZEL**
Bipolar Forceps.....GEN-37
- TESSIER**
Osteotome.....ENT-88
- TEST INSTRUMENTS**
Neurological.....NEU-134
- THOMAS**
Uterine Curette.....OBGYN-9
- THOMPSON**
Carotid Clamp.....CVT-24
Valve Scissors.....CVT-207
- THOMS-ALLIS**
Tissue Forceps.....CVT-110, GEN-109
- THOMS-GAYLOR**
Uterine Biopsy Forceps.....OBGYN-25
- THOREK**
Thoracic Scissors.....CVT-206
- THORNTON**
Fixation Ring.....OPH-48
Optical Zone Marker.....OPH-39
- THORPE**
Conjunctival Fixation Forceps.....OPH-24
- TICKNER**
Forceps.....CVT-111, PED-48
Tissue Forceps.....GEN-109
- TIECK**
Infant Nasal Speculum.....ENT-139
- TISCHLER**
Biopsy Punch.....OBGYN-32
Cervical Biopsy Forceps.....OBGYN-14
Uterine Biopsy Forceps.....OBGYN-25
- TISSUE & CUTICLE NIPPERS**.....GEN-137
- TISSUE FORCEPS**
Dressing.....PED-45
Fixation.....PED-45
General Purpose.....CVT-99-111, GEN-77-114, LAP-9,
LAP-17, NEU-38-40, OBE-23, OBE-30-34, OPH-12,
PED-16, PED-45, PED-47-49
Iris.....PED-45
Micro.....PED-45
Pediatric.....PED-45-49
Utility.....PED-49
Vascular.....PED-49
- TIVNEN**
Tonsil Forceps.....ENT-63

- TOBEY**
Ear Forceps.....ENT-49
- TOFFEL**
Punch.....ENT-100
- TONGUE DEPRESSORS**
with Cheek Retractor..... ENT-118
University of Minnesota Retractor & Tongue
Depressor.....RET-61
- TONOMETERS**.....OPH-73
- TOOKE**
Corneal Knife.....OPH-35
- TOURNIQUETS**
Cardiovascular.....CVT-225
Obturator.....PED-49
- TOWNLEY**
Caliper.....OPH-2
- TOYNBEE**
Speculum.....ENT-144-145
- TRACHEAL TUBES**
Laryngectomy.....ENT-148
- TRANSPAK**.....SS-36
- TRANSPHENOIDAL INSTRUMENTS**.....NEU-134
- TREPHINES**.....NEU-137, SPN-192
- TROCARS**
Antrum.....ENT-148
with Cannula.....ENT-5
General Purpose.....CVT-225, GEN-328
Laparoscopic.....LAP-29
Sinus & Nasal.....ENT-148
- TROUSSEAU**
Tracheal Dilator.....ENT-19, GEN-20, PED-7
- TROUTMAN**
Alpha-Chymotrypsin Cannula.....OPH-7
Needle Holder.....OPH-44
- TROUTMAN-BARRAQUER**
Corneal Utility Forceps.....OPH-25
Needle Holder.....OPH-44
- TROUTMAN-CASTROVIEJO**
Corneoscleral Scissors.....OPH-64
- TROUTMAN-KATZIN**
Corneal Scissors.....OPH-64
- TUFFIER**
Rib Reg.....RET-105
Rib Retractor.....CVT-169
Rib Spreader.....CVT-220
- TUNING FORKS**
Sinus & Nasal.....ENT-148
- TUNNELERS**.....CVT-226
- TURNER-DOYEN**
Retractor.....CVT-139, GEN-235, RET-60
- TUTTLE (SINGLEY)**
Tissue Forceps.....GEN-112, OBE-33
- TYDING**
Tonsil Snare.....ENT-138
- TYLER-GIGLI**
Wire Saw.....NEU-113
- TYRELL**
Iris Hook.....ENT-66, GEN-131, PED-18
- U**
- U.B.**
Pediatric Retractor System.....PED-26
- U.S. PATTERN**
Tube Occluding Forceps.....GEN-15
- UEBE**
Cotton Applicator.....GEN-2
- ULTRA™**
ACF Blade.....SPN-108
ACF Bone Graft Harvesting Forceps.....SPN-58
ACF Bone Tamp.....SPN-190
ACF Color Coded Depth Gauge.....SPN-62
ACT Side Loading Twist Drill.....SPN-45
Blade Loading Locking Retractor Handle.....CVT-156
Bone Graft Holder.....SPN-66
Container System.....LAP-95, SS-10-16
Endarterectomy Scissors.....CVT-198
Ergonomic Needle Holder.....LAP-29
Greenberg® Style Cranial Pattie Tray.....RET-84
Kleppinger Type Bipolar Forceps.....LAP-90-91
Knot Pusher.....LAP-29
Laparoscopic Electrodes.....ENG-51
Light Bulldog Clamp.....CVT-23
Mayo Swivel Blade.....CVT-159
Micro Needle Holders.....GEN-144
Micro Nerve Hook.....NEU-50
Micro Ring Tip Forceps.....CVT-92, CVT-96
Monopolar Laparoscopic Forceps.....ENG-35-49
Needle Holder.....LAP-30, OPH-44
Oval Cup Forceps.....ENT-59
Palpation Probe.....LAP-30
Puncture Needle with Aspiration.....LAP-30
Retractor Blade.....SPN-111
Retractors.....GEN-207
ReVeal ACF Blades.....SPN-129
ReVeal ACF Cervical Retractor Tray.....SPN-103
ReVeal ACF Distraction System.....SPN-101
ReVeal ACF Removal Body Tray.....SPN-102
ReVeal Basic View Retractor System.....SPN-100
ReVeal LoPro Retractor Tray.....SPN-104
ReVeal Lumbar Instrument Blades.....SPN-109
ReVeal Lumbar Instrument System.....SPN-105,
SPN-106
ReVeal Lumbar Retractor Body.....SPN-122
ReVeal Multi-Level Retractor System.....SPN-105
Side Loading Longitudinal Retractor.....SPN-100

Side Loading RetractorCVT-160, RET-74
 Side Loading Transverse RetractorSPN-100
 Sternal Needle Holder GEN-151
 Swivel Blade CVT-156
 Swivel Retractor Blade..... GEN-203
 Titanium Bulldog Artery Clamp..... CVT-23
 Titanium Bulldog Vein Clamp..... CVT-23
 Titanium Tying Forceps..... OPH-26
 Tungsten Carbide Needle Holder LAP-31
 Wire Twister SPN-195
 Wire Twister & Sternal Needle Holder..... O/A-112

ULTRA LIGHT

Needle Holder GEN-156

ULTRA™ REVEAL

Anterior Cervical Fusion Retractor Kits RET-138-143

UNIVERSAL

Bandage Scissors.....GEN-255
 Hand Held Case & LidO/A-13
 Hex DriverO/A-18

UNIVERSAL RING

Pediatric System RET-21

UNIVERSAL RING BLADES

Big Boy..... GEN-204, RET-28
 Deaver RET-28
 Harrington GEN-204-205, RET-28
 Harrington Pediatric RET-29
 Kelly GEN-205, RET-29
 Meyerding GEN-205, RET-29
 Retractor Blades..... GEN-204-205, RET-28-30
 Scoville..... RET-30
 Yu-Holtgrew..... GEN-206, RET-30

UNIVERSITY OF KANSAS

Corneal Forceps..... OPH-26

UNIVERSITY OF MINNESOTA

Retractor & Tongue Depressor..... ENT-118, RET-61

URETHROTOME SETURO-5

URETTS-ZAVALIA

Depressor Pick..... OPH-9

US ARMY

OsteotomeSPN-94
 Chisel O/A-7, SPN-7
 Osteotomes.....O/S-70
 Retractor CVT-183, GEN-236, O/A-87, RET-61,
 SPN-100

UTRATA

Forceps..... OPH-24, OPH-25, OPH-26

V**VALIN**

Hemilaminectomy Retractor SetSPN-119, RET-121

VALVULOTOMES CVT-227

VAN ALYEA

Antrum Trochar ENT-148

Sinus Cannula..... ENT-5

VAN BUREN

Catheter Guide.....URO-3
 Urethral SoundsURO-6, URO-7

VANDERBILT UNIVERSITY

Clamp CVT-54, GEN-7
 Vessel Forceps..... CVT-114

VANNAS

Capsulotomy Scissors..... OPH-65
 Dissecting ScissorsGEN-281

VARCO

Gallbladder Forceps..... GEN-112

VERBUGGE

Bone Holding Forceps..... O/A-36-37

VERRES

Needle LAP-31

VERUCCA

Curette..... GEN-18

VIENNA

Nasal Speculum..... ENT-139, RET-40

VIRTUS

Splinter Forceps GEN-69

VOGEL

Adenoid Curette ENT-10

VOLKMANN

Bone HookO/A-48
 Curette..... SPN-38
 Finger RetractorGEN-215
 Retractors..... CVT-183, ENT-109, GEN-236,
 O/A-87-88, OBE-51, RET-42, RET-61, RET-68-70

VON GRAEFE

Strabismus Hook OPH-33
 Fixation Forceps..... GEN-112, PED-45

VORSE

Tubing Clamp..... GEN-16

W**WAGNER**

MalletO/A-62
 Scissors GEN-257

WALDMANN

Episiotomy ScissorsOBGYN-43

WALSHAM

Septum Straightening Forceps.....ENT-60

WALTER

Splinter Forceps GEN-69

WALTHER

Female Dilator-CatheterURO-3
 Urethral SoundURO-7

WALTON

Cartilage Clamp..... O/A-8

WANGENSTEEN

Classic Plus® Needle Holder CVT-134, GEN-171,
OBE-39
Tissue Forceps.....GEN-113

WARTENBERG

Pin WheelGEN-173

WATSON WILLIAMS

Nasal Polyp Forceps ENT-59

WATZKE

Sleeve Spreading Forceps..... OPH-25

WAUGH

Tissue Forceps.....GEN-113

WAVE

Atraumatic Grasping Forceps..... LAP-44, LAP-61,
LAP-74, LAP-82, LAP-90
Grasping Forceps LAP-67

WEARY

Nerve Hook..... NEU-51
Nerve Root Retractor PED-25, RET-135, SPN-131

WEBSTER

Infusion Needle GEN-172
Needle Holder GEN-171

WEIL-BLAKESLEY

Nasal Forceps..... ENT-57-58, PED-15

WEINBERG

Vagotomy Retractor GEN-250, RET-156

WEINGARTNER

Ear Forceps ENT-49

WEINSTEIN

Instrument Stringers CVT-61, GEN-313
Rack..... SS-47

WEISENBACH

Instrument Stringer CVT-220-221, GEN-312,
GEN-313

WEISMAN-GRAVES

Vaginal Speculum OBGYN-52

WEITLANER

Pediatric Retractor ENT-113
Retractors..... CVT-173, ENT-114, GEN-247-248,
O/A-93, OBE-51, PED-29, RET-69-70, SPN-134

WEITLANER-BECKMAN

Retractor GEN-248, O/A-93, RET-69

WEITLANER-WULLSTEIN

Retractor RET-70

WERTHEIM-CULLEN

Kidney Clamp GEN-10, URO-4

WESCOTT

Stitch Scissors..... CVT-205, GEN-295
Tenotomy Scissors..... GEN-300

WESTCOTT

Scissors OPH-65, OPH-66, PED-39, PED-41

WHEELER

Cyclodialysis Spatula OPH-68
Plaque Forceps CVT-95

WHITE

Tonsil Forceps..... ENT-63, GEN-116

WIEDER

Tongue Depressors..... GEN-19

WIENER

Antrum Rasp..... ENT-102

WIKSTROEM

Artery Forceps..... CVT-75, GEN-29

WILDE

Dressing Forceps ENT-47
Intervertebral Disc Rongeur PED-32
Intervertebral Disc Rongeur Micropak NEU-104

WILDER

Lacrimal Dilator OPH-10
Lens Loop OPH-36

WILLAUER-ALLIS

Forceps..... CVT-111
Tissue Forceps..... CVT-111, GEN-113, OBE-33

WILLIAMS

Discectomy Rongeur NEU-104, SPN-152
Lacrimal Probe..... OPH-46
Micro Discectomy Retractor RET-71, SPN-129
Microlumbar Discectomy Suction Retractor
SPN-129, SPN-188
Microlumbar Forceps..... SPN-61
Retractor..... NEU-84
Splinter Forceps GEN-70
Tissue Forceps..... GEN-113

WILLIGER

Bone Curette SPN-14

WILLS HOSPITAL

Utility Forceps..... OPH-26

WILMER

Angled Scissors GEN-253, OPH-66

WILTSE-GELPI

Retractor..... GEN-248, O/A-93, RET-71

WINTER

Placenta Forceps OBGYN-22

WIRE & TRACTION

Classic Plus® Suture Scissors CVT-206
Pliers O/A-110
Pliers/Cutter O/A-110
Tightener..... O/A-111
Traction Bow..... O/A-111
Twisters GEN-329, GEN-150-151, O/A-112
Twisters with Needle Holder..... CVT-133
Wire & Pin Cutters CVT-227, GEN-328-329, O/A-113,
SPN-192-195

WIRE GUIDES

Middle Ear ENT-148

WIRE TWISTERS..... SPN-195

WITTNER

Uterine Biopsy Punch.....OBGYN-33

WOLFE-BOEHLER

Cast Breaker O/A-2

WOODSON

Dural Separator & Packer GEN-22, NEU-122
Elevator NEU-27, OBE-22, SPN-58
Elevator Spatula NEU-27, OBE-78, SPN-58
MagnaFree® Elevator & Spatula.....GEN-21, NEU-22
Separator PackerNEU-122, SPN-95

WORLAND

PCL Retractor.....O/A-91, RET-95

WRENCHES

Spanner SPN-195

WRIGHT

Fascia Needle..... OPH-40

WULLSTEIN-WEITLANER

Retractor ENT-114

WYLIE

Hypogastric ClampCVT-31
"J" Clamp.....CVT-31
Renal Retractor..... GEN-238

Y**YANKAUER**

Suction Tube..... CVT-224, GEN-327, OBE-80

YASARGIL

Bayonet Bipolar Forceps ENG-20, GEN-40-41
Bayonet Forceps..... GEN-33, NEU-29
Bayonet Needle Holder NEU-58
Bayonet ScissorsNEU-113
Bayonet Tumor Grasping ForcepsNEU-40
Ligature Carrier..... NEU-56
Micro Bayonet Forceps..... GEN-65, NEU-35
Micro Bayonet ScissorsNEU-116
Micro CuretteNEU-9
Micro Suction Tube GEN-328, NEU-129
Microvascular Knife..... NEU-55
Spoon Forceps.....NEU-37
Spring Hook..... NEU-52

YEOMAN

Rectal Biopsy ForcepsREC-2

YOUNG

Prostatic Retractor REC-5, RET-98

YU-HOLTGREW

Retractor BladeCVT-158, GEN-206, RET-30

Z**ZALKIND**

Lung RetractorCVT-166

ZANGER

Abdominal Aorta ClampCVT-3

ZAUFAL-JANSEN

Rongeur ENT-122, NEU-87, O/A-104, SPN-142

ZEP

Atraumatic Hysterectomy Forceps.....OBGYN-18-20
Scissors GEN-283, OBE-76, OBGYN-44

ZIPSER

Penile Meatus ClampURO-4

30	SS-46	222.50.63	GEN-298, OPH-58	1021	SS-20
30P	SS-46	223.50.67	GEN-267	1023	SS-20
31	SS-46	223.51.64	GEN-267	1025	SS-20
31P	SS-46	223.51.67	GEN-267	2001	SS-15
202.20.10	GEN-286, OPH-63	223.51.73	GEN-267	2011	SS-20
202.21.10	GEN-286, OPH-63	223.56.67	GEN-270	2021	SS-20
202.41.12	GEN-280	223.57.67	GEN-270	2023	SS-20
202.50.12	GEN-300, OPH-63	224.32.64	GEN-271	2024	SS-20
202.50.13	GEN-300, OPH-63	224.32.68	GEN-271	2025	SS-20
203.06.14	GEN-294	224.33.61	GEN-271	5022	O/A-11, SS-18
203.50.14	GEN-268	224.33.64	GEN-271	5108	SS-24
203.50.17	GEN-268	224.33.68	GEN-271	5109	SS-24
203.51.17	GEN-268	224.33.70	GEN-271	5110	SS-24
203.51.23	GEN-268	224.33.73	GEN-271	5111	O/A-11, SS-18, SS-24
204.32.30	GEN-279	224.35.64	GEN-276	5112	SS-24
204.33.11	GEN-277	224.35.68	GEN-276	5113	SS-24
204.35.18	GEN-277	224.35.73	GEN-276	5120	SS-28
204.35.23	GEN-277	224.56.77	GEN-306	5121	SS-28
204.50.15	ENT-133	224.67.12	GEN-261	5122	SS-28
204.51.15	ENT-133, GEN-262	224.67.16	GEN-261	5130	O/A-53, SS-28
204.67.13	GEN-300, OPH-64	224.67.63	GEN-298, OPH-58	5150-A	GEN-238, RET-102, URO-5
212.20.11	GEN-286, OPH-62	224.67.66	GEN-261	5150-B	GEN-238, RET-102, URO-5
212.21.11	OPH-62	224.67.68	GEN-261	5150-C	GEN-238, RET-102, URO-5
212.50.12	GEN-297, OPH-63	224.73.69	GEN-260	5150-D	GEN-238, RET-102, URO-5
212.50.13	GEN-297, OPH-63	224.77.69	GEN-257	5200	LAP-32, O/A-11, SS-28
213.50.17	GEN-268	225.15.32	CVT-210, GEN-304	5200N	LAP-32, SS-28
213.51.17	GEN-268	225.15.34	CVT-210, GEN-304	5200S	SS-18
213.51.23	GEN-268	225.15.36	CVT-210, GEN-304	5210	SS-28, SS-34
213.56.15	GEN-270	225.15.39	CVT-210, GEN-304	5211	SS-28
213.56.17	GEN-270	225.15.40	CVT-211, GEN-304	5212	SS-34
213.57.17	GEN-270	225.15.42	GEN-306	5215	SS-28
214.13.15	GEN-280	225.15.43	CVT-211, GEN-306	5216	SS-28
214.32.14	GEN-276	225.15.44	CVT-211, GEN-306	5231	SS-27
214.32.18	GEN-276	225.15.46	CVT-211, GEN-306	5233	O/A-11, SS-18, SS-27
214.33.11	GEN-271	227.53.36	ENT-126	5235	SS-28
214.33.14	GEN-276	255.15.36	CVT-215	5236	SS-28
214.33.18	GEN-276	255.15.42	CVT-215	5237	SS-28
214.33.20	GEN-276	255.15.44	CVT-215	5238	SS-28
214.33.23	GEN-279	267.53.13	GEN-260	5241	SS-27
214.33.26	GEN-279	267.53.16	GEN-258	5250	SS-27
214.33.30	GEN-279	0101	SS-20	5251	SS-27
214.34.14	GEN-272	0103	SS-20	5300	SS-26
214.35.14	GEN-272	0105	SS-19	5301	SS-26
214.35.18	GEN-272	0111	SS-20	5302	SS-26
214.35.23	GEN-272	0116	SS-19	5310	SS-27
214.50.15	GEN-262	0119	SS-19	5311	SS-27
214.51.15	GEN-262	0126	SS-20	5312	SS-26
214.55.77	GEN-296	0127	SS-20	5320	SS-27
214.56.77	GEN-296	0128	SS-20	5330	SS-27
214.67.12	ENT-134, GEN-261	0207	SS-19	5331	SS-27
214.67.13	ENT-134	0211	SS-20	5332	SS-26
214.67.16	ENT-134, GEN-261	0212	SS-19	5333	SS-26
214.68.18	GEN-261	0217	CVT-59, SS-19		
222.20.61	GEN-260, OPH-57	0220	SS-19		
222.21.61	GEN-285, OPH-57	1011	SS-20		
222.50.62	GEN-298, OPH-58	1015	SS-20		

5334.....	SS-27	11800.....	ENG-30	41401.....	ENG-27
5335.....	SS-26	11802.....	ENG-30	41402.....	ENG-27
5339.....	SS-26	11803.....	ENG-30	41403.....	ENG-27
5340.....	SS-26, SS-34	11804.....	ENG-30	41405.....	ENG-60
5341.....	SS-26, SS-34	11901.....	ENG-30	41406.....	ENG-60
5343.....	SS-26, SS-34	11903.....	ENG-30	41601.....	ENG-27
5350.....	SS-34	11904.....	ENG-30	41602.....	ENG-27
5351.....	SS-34	11906.....	ENG-30	41604.....	ENG-27
5352.....	SS-26, SS-34	12000.....	ENG-30	41605.....	ENG-27
5353.....	SS-26, SS-34	12003.....	ENG-30	41607.....	ENG-60
5354.....	SS-34	12004.....	ENG-30	41700.....	ENG-28
5355.....	SS-34	12005.....	ENG-30	41701.....	ENG-28
5370.....	SS-27	12100.....	ENG-29	41702.....	ENG-28
5371.....	SS-27	12101.....	ENG-29	41703.....	ENG-28
5372.....	SS-26	12102.....	ENG-29	42200.....	ENG-30
5373.....	SS-26	12103.....	ENG-29	42201.....	ENG-30
5374.....	SS-27	12200.....	ENG-29	42202.....	ENG-30
5375.....	SS-26	12202.....	ENG-29	42203.....	ENG-30
5500.....	O/A-11, SS-18	12203.....	ENG-29	42207.....	ENG-60
7024.....	SS-24	12204.....	ENG-29	42208.....	ENG-60
7026.....	SS-18, SS-24	20002.....	ENG-58, ENT-30	42209.....	ENG-60
7113.....	SS-24	20003.....	ENG-58, ENT-30	42211.....	ENG-60
7200.....	SS-28	20006.....	ENG-58, ENT-30	42300.....	ENG-30
7200X.....	SS-18	28100.....	SS-31	42301.....	ENG-30
7513.....	SS-24	28101.....	SS-32	42302.....	ENG-30
7513X.....	SS-18	28104.....	SS-32	42304.....	ENG-30
7726.....	SS-18	28106.....	SS-32	42307.....	ENG-60
8600.....	SS-36	28107.....	SS-32	42308.....	ENG-60
9020.....	SS-2	28108.....	SS-32	42309.....	ENG-60
9030.....	SS-2	28120.....	SS-32	42400.....	ENG-30
9040.....	SS-2	28122.....	SS-31	42402.....	ENG-30
9050.....	SS-2	28123.....	SS-31	42404.....	ENG-30
9090.....	SS-3	28124.....	SS-32	42405.....	ENG-30
9111.....	SS-3	28125.....	SS-32	42408.....	ENG-60
9312.....	LAP-33, SS-33	28126.....	SS-31	42409.....	ENG-60
9317.....	LAP-33, SS-33	28128.....	SS-31	42410.....	ENG-60
9321.....	LAP-33, SS-33	28129.....	SS-31	42411.....	ENG-60
9326.....	LAP-33, SS-33	28130.....	SS-31	42500.....	ENG-29
9331.....	LAP-33, SS-33	28131.....	SS-31	42502.....	ENG-29
9417.....	SS-33	28134.....	SS-32	42503.....	ENG-29
11100.....	ENG-27, ENT-34	28200.....	SS-31	42505.....	ENG-29
11101.....	ENG-27, ENT-34	41100.....	ENG-27	42509.....	ENG-60
11102.....	ENG-27, ENT-34	41101.....	ENG-27	43103.....	ENG-29
11104.....	ENG-27, ENT-34	41102.....	ENG-27	43104.....	ENG-29
11200.....	ENG-27, ENT-34	41103.....	ENG-27	43109.....	ENG-29
11204.....	ENG-27, ENT-34	41200.....	ENG-27	43110.....	ENG-29
11205.....	ENG-27, ENT-34	41201.....	ENG-27	43200.....	SS-18
11206.....	ENG-27, ENT-34	41202.....	ENG-27	43203.....	ENG-29
11208.....	ENG-27, ENT-34	41203.....	ENG-27	43204.....	ENG-29
11210.....	ENG-27, ENT-34	41206.....	ENG-60	44000.....	ENG-60
11212.....	ENG-27, ENT-34	41207.....	ENG-60	44004.....	ENG-60
11213.....	ENG-27, ENT-34	41300.....	ENG-28	44005.....	ENG-60
11600.....	ENG-27, ENT-34	41301.....	ENG-28	44006.....	ENG-60
11602.....	ENG-27, ENT-34	41302.....	ENG-28	44012.....	ENG-60
11604.....	ENG-27, ENT-34	41304.....	ENG-28	44013.....	ENG-60
11605.....	ENG-27, ENT-34	41400.....	ENG-27	50001.....	ENG-64

50002.....	ENG-64	66214.....	ENG-31	75541.....	ENG-62
50101.....	ENG-64	66215.....	ENG-31	75610.....	ENG-63
50102.....	ENG-64	66300.....	ENG-52	75620.....	ENG-63
50201.....	ENG-64	66301.....	ENG-52	75621.....	ENG-63
50202.....	ENG-64	66302.....	ENG-52	75800.....	ENG-63
50301.....	ENG-64	66303.....	ENG-52	75802.....	ENG-63
52420-00.....	LAP-27	66304.....	ENG-52	75810.....	ENG-63
52420-01.....	LAP-27	66305.....	ENG-52	75820.....	ENG-63
52420-02.....	LAP-27	66306.....	ENG-52	77000.....	ENG-64, ENT-32
52420-03.....	LAP-27	66307.....	ENG-52	77001.....	ENG-64, ENT-32
65000.....	ENG-62	66308.....	ENG-52	77005.....	ENG-64, ENT-32
65006.....	ENG-62	66700.....	ENG-32	77006.....	ENG-64, ENT-32
66000.....	ENG-31	66703.....	ENG-32	80000.....	ENG-23
66001.....	ENG-31	66704.....	ENG-32	80001.....	ENG-23
66002.....	ENG-31	66705.....	ENG-32	80002.....	ENG-23
66003.....	ENG-31	66800.....	ENG-54	80003.....	ENG-23
66004.....	ENG-31	67000.....	ENG-54	80004.....	ENG-23
66005.....	ENG-31	67001.....	ENG-54	80100.....	ENG-23
66006.....	ENG-32	67002.....	ENG-54	80101.....	ENG-23
66007.....	ENG-32	67003.....	ENG-54	80102.....	ENG-23
66009.....	ENG-32	67004.....	ENG-54	80103.....	ENG-23
66010.....	ENG-32	67510.....	ENG-51	80104.....	ENG-23
66011.....	ENG-32	67511.....	ENG-51	80200.....	ENG-12, ENT-35
66014.....	ENG-32	67512.....	ENG-51	80201.....	ENG-12, ENT-35
66101.....	ENG-53	67513.....	ENG-51	80202.....	ENG-12, ENT-35
66102.....	ENG-53	67514.....	ENG-51	80204.....	ENG-12, ENT-35
66103.....	ENG-53	67515.....	ENG-51	80205.....	ENG-12, ENT-35
66104.....	ENG-53	67516.....	ENG-51	80300.....	ENG-12, ENT-35
66105.....	ENG-53	68000.....	ENG-32	80301.....	ENG-12, ENT-35
66106.....	ENG-53	68001.....	ENG-32	80302.....	ENG-12, ENT-35
66107.....	ENG-53	68002.....	ENG-32	80303.....	ENG-12, ENT-35
66108.....	ENG-53	68003.....	ENG-32	80304.....	ENG-12, ENT-35
66109.....	ENG-53	68004.....	ENG-32	80400.....	ENG-24, ENT-38
66110.....	ENG-53	68005.....	ENG-32	80401.....	ENG-24, ENT-38
66111.....	ENG-53	68006.....	ENG-32	80402.....	ENG-24, ENT-38
66112.....	ENG-53	68600.....	ENG-33, ENT-33	80403.....	ENG-24, ENT-38
66114.....	ENG-53	68601.....	ENG-33, ENT-33	80404.....	ENG-24, ENT-38
66115.....	ENG-53	68602.....	ENG-33, ENT-33	80430.....	ENG-12, ENT-35
66116.....	ENG-53	68603.....	ENG-33, ENT-33	80431.....	ENG-12, ENT-35
66117.....	ENG-53	69000.....	ENG-52	80432.....	ENG-12, ENT-35
66118.....	ENG-53	69001.....	ENG-52	80433.....	ENG-12, ENT-35
66119.....	ENG-53	69100.....	ENG-52	80434.....	ENG-12, ENT-35
66200.....	ENG-31	69200.....	ENG-52	80570.....	ENG-12, ENT-35
66201.....	ENG-31	69300.....	ENG-52	80571.....	ENG-12, ENT-35
66202.....	ENG-31	69400.....	ENG-52	80572.....	ENG-12, ENT-35
66203.....	ENG-31	69500.....	ENG-52	80573.....	ENG-12, ENT-35
66204.....	ENG-31	69501.....	ENG-52	80574.....	ENG-12, ENT-35
66205.....	ENG-31	69502.....	ENG-52	80580.....	ENG-12, ENT-35
66206.....	ENG-31	69503.....	ENG-52	80581.....	ENG-12, ENT-35
66207.....	ENG-31	69504.....	ENG-52	80582.....	ENG-12, ENT-35
66208.....	ENG-31	69505.....	ENG-52	87006.....	ENG-58, ENT-30
66209.....	ENG-31	69506.....	ENG-52	87110.....	ENG-58, ENT-30
66210.....	ENG-31	69507.....	ENG-52	87600.....	ENG-58, ENT-30
66211.....	ENG-31	75000.....	ENG-62	90018.....	ENG-59, ENT-31, LAP-93
66212.....	ENG-31	75530.....	ENG-62	90020.....	ENG-59, ENT-31, LAP-93
66213.....	ENG-31	75540.....	ENG-62	90054.....	ENG-59, ENT-31, LAP-93

90056	ENG-59, ENT-31, LAP-93	504805	OBE-37	677112	OBE-10
90065	ENG-59, ENT-31, LAP-93	504806	OBE-37	677113	OBE-10
90067	ENG-59, ENT-31, LAP-93	504807	OBE-37	677114	OBE-10
92002	ENG-59	504808	OBE-37	677115	OBE-10
95012	ENG-63	504809	OBE-37	677116	OBE-10
95017	ENG-63	504810	CVT-152, GEN-199	677117	OBE-10
96000	ENG-61, ENT-33	504811	CVT-152, GEN-199	677118	OBE-10
96001	ENG-61, ENT-33	504812	CVT-152, GEN-199	677119	OBE-10
96002	ENG-61, ENT-33	504813	CVT-152, GEN-199	677120	OBE-10
97000	ENG-50	505580	CVT-143, GEN-190	677121	OBE-10
97001	ENG-50	505581	CVT-143, GEN-190	677122	OBE-10
97002	ENG-50	505582	CVT-143, GEN-190	677186	OBE-11
97100	ENG-55	505583	CVT-143, GEN-190, OBE-55	677187	OBE-11
97101	ENG-55	505584	CVT-143, GEN-190, OBE-55	677188	OBE-11
97110	ENG-55	505585	CVT-143, GEN-190	677189	OBE-11
97111	ENG-55	505586	CVT-143, GEN-190	677190	OBE-11
97112	ENG-55	505587	CVT-143, GEN-190	677191	OBE-11
97114	ENG-55	505588	CVT-143, GEN-190, OBE-55	677192	OBE-11
97115	ENG-55	505589	CVT-143, GEN-190, OBE-55	677193	OBE-11
97116	ENG-55	531540CD	NEU-102, SPN-175	677194	OBE-11
97117	ENG-55	531542CD	NEU-102, SPN-175	677209	OBE-11
97125	ENG-55	531544CD	NEU-102, SPN-175	677211	OBE-11
97130	ENG-56	531546CD	NEU-102, SPN-175	677212	OBE-11
97131	ENG-56	531548CD	NEU-102, SPN-175	677213	OBE-11
97132	ENG-56	531550CD	NEU-102, SPN-175	677214	OBE-11
97133	ENG-56	531552CD	NEU-102, SPN-175	677215	OBE-11
97134	ENG-56	531554CD	NEU-102, SPN-175	677216	OBE-11
97135	ENG-56	531570CD	NEU-102, SPN-175	677218	OBE-16
97136	ENG-56	531572CD	NEU-102, SPN-175	677219	OBE-16
97137	ENG-56	531574CD	NEU-102, SPN-175	677221	OBE-11
97138	ENG-56	531576CD	NEU-102, SPN-175	677282	OBE-69
97139	ENG-56	660008	ENG-32	677285	OBE-69
97140	ENG-56	671000	OBE-29	677288	OBE-69
97141	ENG-56	671001	OBE-29	677297LED	SPN-182
97142	ENG-56	677028	OBE-20	677298LED	SPN-182
97143	ENG-56	677029	OBE-20	677299LED	SPN-182
97144	ENG-56	677030	OBE-20	677300LED	SPN-182
97145	ENG-56	677031	OBE-20	677304LED	SPN-182
97146	ENG-56	677032	OBE-20	677305LED	SPN-182
97147	ENG-56	677033	OBE-20	677314	OBE-71
97148	ENG-56	677034	OBE-20	677315	OBE-71
97152	ENG-56	677035	OBE-20	677316	OBE-71
97154	ENG-56	677036	OBE-20	677317	OBE-71
97170	ENG-56	677037	OBE-20	677318	OBE-71
97171	ENG-56	677104	OBE-10	677323	OBE-70
97200	ENG-31	677105	OBE-10	677324	OBE-70
97201	ENG-31	677106	OBE-10	677390	OBE-19
97500	ENG-65, ENT-33	677107	OBE-10	677391	OBE-19
97501	ENG-65, ENT-33	677108	OBE-10	677392	OBE-19
245201	LAP-37	677109	OBE-10	677393	OBE-19
501223	CVT-177	677110	OBE-10	677394	OBE-19
504222CO	CVT-183, RET-61, RET-68	677111	OBE-10	677395	OBE-19
504227CO	CVT-183, RET-61, RET-68			677396	OBE-19
504685	GEN-210			677397	OBE-19
504687	CVT-152, GEN-199			677398	OBE-19
504688	CVT-155, GEN-203, OBE-64			677410	OBE-20
504695	RET-23				
504697	CVT-155, GEN-203, OBE-64				

677411.....	OBE-20	677645.....	OBE-75	1010128.....	O/A-72
677412.....	OBE-20	677646.....	OBE-75	1010129.....	O/A-72
677413.....	OBE-20	677647.....	OBE-75	1010130.....	O/A-75
677414.....	OBE-20	677648.....	OBE-75	1010131.....	O/A-75
677415.....	OBE-20	681590.....	LAP-24	1010131LP.....	O/A-72
677416.....	OBE-20	681591.....	LAP-24	1010132.....	O/A-75
677417.....	OBE-20	681593.....	LAP-24	1010133.....	O/A-74
677418.....	OBE-20	681594.....	LAP-24	1010134.....	O/A-73
677419.....	OBE-20	801003.....	NEU-128	1010135.....	O/A-73
677462.....	OBE-51	979150.....	ENG-56	1010136.....	O/A-75
677463.....	OBE-51	1000400.....	O/A-73	1010137.....	O/A-73
677464.....	OBE-51	1000401.....	O/A-74	1010138.....	O/A-74
677465.....	OBE-51	1000442.....	O/A-106	1010138LP.....	O/A-72
677466.....	OBE-51	1000443.....	O/A-106	1010139LP.....	O/A-72
677467.....	OBE-51	1000641.....	O/A-107	1010202.....	O/A-106
677468.....	OBE-51	1000642.....	O/A-107	1010204.....	O/A-106
677469.....	OBE-51	1000643.....	O/A-107	1010208.....	O/A-106
677489.....	OBE-48	1000644.....	O/A-107	1010209.....	O/A-106
677490.....	OBE-48	1000647.....	O/A-16	1010210.....	O/A-106
677491.....	OBE-48	1000684.....	O/A-107	1010212.....	O/A-106
677493.....	OBE-48	1000685.....	O/A-107	1010301.....	O/A-33
677494.....	OBE-48	1000686.....	O/A-107	1010302.....	O/A-33
677496.....	OBE-54	1000687.....	O/A-107	1010303.....	O/A-33
677497.....	OBE-54	1000688.....	O/A-16	1010304.....	O/A-33
677499.....	OBE-54	1010101.....	O/A-73	1010305.....	O/A-33
677500.....	OBE-54	1010101LP.....	O/A-72	1010306.....	O/A-33
677501.....	OBE-54	1010102.....	O/A-74	1010401.....	O/A-94
677502.....	OBE-54	1010102LP.....	O/A-72	1010402.....	O/A-94
677503.....	OBE-54	1010103.....	O/A-73	1010501.....	O/A-71
677504.....	OBE-54	1010104.....	O/A-75	1010502.....	O/A-71
677506.....	OBE-54	1010105.....	O/A-74	1010503.....	O/A-71
677507.....	OBE-52	1010106.....	O/A-75	1010601.....	O/A-57
677508.....	OBE-51	1010107.....	O/A-74	1010602.....	O/A-57
677509.....	OBE-51	1010108.....	O/A-75	1010603.....	O/A-57
677521.....	OBE-4	1010109.....	O/A-74	1010701.....	O/A-76
677522.....	OBE-4	1010110.....	O/A-75	1010702.....	O/A-76
677563.....	OBE-29	1010111.....	O/A-73	1010703.....	O/A-76
677564.....	OBE-3	1010112.....	O/A-73	1010801.....	O/A-13
677565.....	OBE-29	1010113.....	O/A-73	1010802.....	O/A-13
677566.....	OBE-29	1010114.....	O/A-73	1010901.....	O/A-42
677568.....	OBE-26	1010115.....	O/A-75	1010902.....	O/A-42
677582.....	OBE-25	1010115LP.....	O/A-72	1020303.....	O/A-62
677583.....	OBE-25	1010116.....	O/A-73	1020304.....	O/A-46
677584.....	OBE-25	1010117.....	O/A-75	1020701.....	O/A-107
677585.....	OBE-25	1010117LP.....	O/A-72	1020702.....	O/A-107
677586.....	OBE-25	1010118.....	O/A-75	1020703.....	O/A-107
677587.....	OBE-25	1010119.....	O/A-75	1020704.....	O/A-107
677611.....	OBE-29	1010119LP.....	O/A-72	1020901.....	O/A-71
677612.....	OBE-27	1010120.....	O/A-73	1021001.....	O/A-47
677615.....	OBE-26	1010121.....	O/A-74	1021101.....	O/A-16
677637.....	OBE-74	1010122.....	O/A-72	1030101.....	O/A-71
677640.....	OBE-75	1010123.....	O/A-72	1030102.....	O/A-71
677641.....	OBE-75	1010124.....	O/A-72	1030103.....	O/A-71
677642.....	OBE-75	1010125.....	O/A-72	1030301.....	O/A-46
677643.....	OBE-75	1010126.....	O/A-72	1040101.....	O/A-73
677644.....	OBE-75	1010127.....	O/A-72	1040301.....	O/A-33

1040401.....	O/A-94	01-2708.....	GEN-133	03-0413.....	GEN-292
1040501.....	O/A-71	01-2709.....	GEN-133	03-0414.....	GEN-292
1701063.....	ENT-2	01-2713.....	GEN-132	03-0415.....	GEN-292
2010101.....	LAP-22	01-2721.....	ENT-64	03-0511.....	GEN-292
2010201.....	LAP-22, OBGYN-28	01-2723.....	GEN-132	03-0513.....	GEN-292
2010202.....	LAP-24	01-2725.....	ENT-64	03-0514.....	GEN-292
2010301.....	LAP-24	01-2726.....	ENT-64	03-0515.....	GEN-292
1-2700.....	SS-20	01-2733.....	GEN-132	03-0611.....	GEN-293
1-2710.....	SS-20	01-2740.....	GEN-131	03-0613.....	GEN-293
1-2720.....	SS-20	01-2746.....	GEN-132, OBE-36	03-0614.....	GEN-293
1-3700.....	SS-20	01-2804.....	GEN-133	03-0615.....	GEN-293
1-3710.....	SS-20	01-2814.....	GEN-133	03-0618.....	GEN-293
1-4800.....	SS-20	01-2850.....	GEN-133	03-3420.....	GEN-294
1-7100.....	SS-20	01-3032L.....	GEN-134	03-5014.....	GEN-265
1-7110.....	SS-20	01-3034.....	GEN-134	03-5017.....	GEN-265
1-7120.....	SS-20	01-3036.....	GEN-134	03-5023.....	GEN-265
2-8102.....	SS-32	01-6708.....	GEN-132	03-5040.....	GEN-265, OBE-74
2-8103.....	SS-32	02-90-10020.....	OBGYN-3	03-5045.....	GEN-265, OBE-74
2-8105.....	SPN-7, SS-32	02-0612.....	GEN-257	03-5114.....	GEN-264
2-8108.....	SPN-8	02-0632.....	GEN-257	03-5117.....	GEN-264
2-8109.....	SPN-7, SS-32	02-2009.....	GEN-284, OPH-54	03-5123.....	GEN-264
2-8110.....	SPN-7, SS-32	02-2010.....	GEN-284, OPH-54	03-5130.....	GEN-264, OBE-74
2-8111.....	SS-32	02-2011.....	GEN-284, OPH-54	03-5131.....	OBE-74
2-8112.....	SPN-8, SS-32	02-2012.....	GEN-284, OPH-54	03-5132.....	GEN-264, OBE-74
2-8113.....	SS-32	02-2042.....	GEN-286, OPH-57	03-5145.....	GEN-264, OBE-74
2-8114.....	SS-32	02-2043.....	GEN-286, OPH-57	03-5220.....	GEN-269
2-8115.....	SS-32	02-2109.....	GEN-284, OPH-54	03-5223.....	GEN-269
2-8116.....	SS-32	02-2110.....	GEN-284, OPH-54	03-5226.....	GEN-269, OBE-76
2-8117.....	SS-32	02-2111.....	GEN-284, OPH-54	03-5320.....	GEN-269
2-8118.....	SS-32	02-2112.....	GEN-284, OPH-54	03-5323.....	CVT-195, GEN-269
2-8119.....	SS-32	02-2142.....	GEN-286, OPH-57	03-5326.....	GEN-269, OBE-76
2-8121.....	SS-32	02-2143.....	OPH-57	03-5330.....	GEN-269, OBE-76
2-8127.....	SS-31	02-4010.....	GEN-263, OPH-57	03-5615.....	GEN-269
3-1210.....	SS-33	02-4110.....	GEN-263, OPH-57	03-5617.....	GEN-269
3-5120.....	O/A-9, SS-33	02-5002.....	GEN-300, OPH-60	03-5715.....	GEN-269
3-5130.....	SS-33	02-5003.....	GEN-300, OPH-60	03-5717.....	GEN-269
3-7110.....	O/A-9, SS-33	02-5012.....	GEN-301, OPH-61	03-5817.....	GEN-270
4-1130.....	SS-18	02-5013.....	GEN-301, OPH-61	04-1350.....	GEN-289
4-1146.....	SS-18	02-5062.....	GEN-259, OPH-53	04-2014.....	ENT-136
4-1200.....	SS-18	02-5063.....	OPH-53	04-2114.....	ENT-136
4-1210.....	SS-18	02-5064.....	GEN-259	04-3214.....	GEN-271
4-2000.....	SS-18	02-5065.....	OPH-53	04-3218.....	GEN-271
5-1110.....	O/A-13	02-5110.....	GEN-301	04-3223.....	GEN-278
5-1150.....	O/A-11, SS-18	02-5111.....	GEN-301	04-3226.....	GEN-278, OBE-77
6-1100.....	SS-19	02-5123.....	GEN-301	04-3230.....	GEN-278, OBE-77
6-1400.....	SS-19	02-5125.....	GEN-301	04-3232.....	GEN-278, OBE-77
6-1800.....	SS-19	03-0211.....	GEN-292	04-3245.....	GEN-278, OBE-77
6-8700.....	SS-19	03-0214.....	GEN-292	04-3314.....	GEN-271
7-1200.....	SS-17	03-0215.....	GEN-292	04-3318.....	GEN-271
7-1250.....	SS-17	03-0216.....	GEN-292	04-3320.....	GEN-271
7-6000.....	SS-17	03-0283.....	GEN-292	04-3323.....	GEN-278
7-6050.....	SS-17	03-0309.....	ENG-17	04-3326.....	GEN-278, OBE-77
01-1004.....	GEN-251	03-0311.....	GEN-292	04-3330.....	GEN-278, OBE-77
01-2003.....	GEN-132	03-0314.....	GEN-292	04-3332.....	GEN-278
01-2703.....	GEN-132	03-0383.....	GEN-292	04-3338.....	GEN-278, OBE-77
01-2707.....	GEN-133	03-0411.....	GEN-292	04-3340.....	GEN-278, OBE-77

04-3345.....	GEN-278, OBE-77	06-1013.....	GEN-110	06-8792.....	GEN-92
04-3414.....	GEN-271	06-1014.....	GEN-110	06-8793.....	GEN-92
04-3418.....	GEN-274	06-1016.....	GEN-110	06-8795.....	GEN-84
04-3423.....	GEN-274	06-1020.....	GEN-110	06-8798.....	GEN-96
04-3514.....	GEN-271	06-1113.....	GEN-110	07-1015.....	GEN-86
04-3518.....	GEN-271, GEN-274	06-1114.....	GEN-110	07-1020.....	GEN-86
04-3520.....	GEN-274	06-1116.....	GEN-110	07-1025.....	GEN-86
04-3523.....	GEN-274	06-1120.....	GEN-110	07-1030.....	GEN-86
04-3526.....	GEN-271	06-1125.....	GEN-110	07-1406.....	GEN-107
04-5015.....	ENT-132	06-1966.....	GEN-103	07-1410.....	GEN-107
04-5016.....	ENT-132	06-2001.....	GEN-46	07-1515.....	GEN-106
04-5075.....	ENT-124	06-2005.....	GEN-96	07-1520.....	GEN-106
04-5076.....	ENT-124	06-2012.....	GEN-43	07-1525.....	GEN-106
04-5115.....	ENT-132	06-2012T.....	GEN-114	07-1530.....	GEN-106, OBE-33
04-5116.....	ENT-132	06-2014.....	GEN-43	07-1718.....	GEN-112
04-5416.....	ENT-127	06-2112.....	GEN-43	07-1723.....	GEN-112
04-5516.....	ENT-127, GEN-283	06-2112T.....	GEN-114	07-1724.....	GEN-112, OBE-33
04-5677.....	GEN-301	06-2113.....	GEN-77	07-1727-H.....	OBE-33
04-6712.....	GEN-280, OPH-59	06-2113E.....	GEN-77	07-1728.....	GEN-112, OBE-33
04-6714.....	GEN-280, OPH-59	06-2212.....	GEN-101	07-1915.....	GEN-102
04-6716.....	GEN-280	06-2215.....	GEN-101	07-2618.....	GEN-31
04-6718.....	GEN-280	06-2216.....	GEN-43	07-2618-R.....	GEN-31
04-6718L.....	GEN-280	06-2312.....	GEN-101	07-2619.....	GEN-31
04-7018.....	CVT-209, GEN-259	06-2315.....	GEN-101	07-2620.....	GEN-33
04-7119.....	CVT-209	06-2413.....	GEN-77	07-2718.....	GEN-31
04-7425.....	CVT-210	06-2512.....	GEN-79	07-2879.....	GEN-88
04-7427.....	CVT-188	06-2572.....	GEN-79	07-3014.....	GEN-48
04-7526.....	CVT-208	06-2582.....	GEN-79	07-3016.....	GEN-47
04-7527.....	CVT-188	06-2590.....	GEN-114	07-3019.....	GEN-47
05-1220.....	GEN-288, OPH-58	06-3010.....	GEN-63	07-3019XL.....	GEN-32
05-1221.....	GEN-288, OPH-58	06-3012.....	GEN-49	07-3020.....	GEN-32
05-1230.....	GEN-288, OPH-58	06-3022.....	GEN-49	07-3074.....	ENT-48
05-1231.....	GEN-288, OPH-58	06-3030.....	GEN-63	07-3114.....	GEN-48
06-0011.....	GEN-45	06-3110.....	GEN-63	07-3119.....	GEN-47
06-0013.....	GEN-45	06-3112.....	GEN-49	07-5016.....	GEN-99
06-0014.....	GEN-45	06-3115.....	GEN-107	07-6612.....	GEN-65
06-0015.....	GEN-45	06-3130.....	GEN-63	07-7015.....	GEN-65
06-0018.....	GEN-45	06-4085.....	GEN-95	07-7018.....	GEN-65
06-0020.....	GEN-45	06-4088.....	GEN-47	07-8009.....	GEN-69
06-0020E.....	GEN-45	06-4135.....	GEN-113	07-8010.....	GEN-69
06-0025.....	GEN-45, OBE-24	06-4215.....	GEN-113	07-8011.....	GEN-69
06-0025E.....	GEN-45	06-4220.....	GEN-113	07-8108.....	GEN-69
06-0030.....	GEN-45, OBE-24	06-4638.....	GEN-49, OBE-25	07-8109.....	GEN-69
06-0035.....	GEN-45, OBE-24	06-4818.....	GEN-104	07-8110.....	GEN-69
06-0040.....	GEN-45, OBE-24	06-4820.....	GEN-104	07-8111.....	GEN-69
06-0045.....	GEN-45, OBE-24	06-4825.....	GEN-104	07-8211.....	GEN-68
06-0511.....	GEN-110	06-4835.....	GEN-104, OBE-32	07-8611.....	GEN-69
06-0513.....	GEN-110	06-4838.....	GEN-104	07-8621.....	GEN-69
06-0514.....	GEN-110	06-5614.....	GEN-110	07-8681.....	GEN-69
06-0515.....	GEN-110	06-6017.....	CVT-115	07-9011.....	GEN-70
06-0518.....	GEN-110	06-6018.....	CVT-115	07-9114.....	GEN-70
06-0520.....	GEN-110	06-6087.....	CVT-115	07-9424.....	GEN-69
06-0525.....	GEN-110, OBE-33	06-6088.....	CVT-115	07-9425.....	GEN-69
06-0530.....	GEN-110, OBE-33	06-8782.....	GEN-84	08-0000.....	ENG-14, GEN-37
06-0535.....	GEN-110, OBE-33	06-8790.....	GEN-84	08-0000I.....	ENG-14, ENT-36,
06-0545.....	GEN-110, OBE-33	06-8791.....	GEN-84		GEN-37

08-0001	ENG-23	08-0090	ENG-17, GEN-38	09-1120	GEN-176
08-0002	ENG-23, GEN-35	08-0091	ENG-17, GEN-38	09-1300	ENT-95
08-0003	GEN-37	08-0092	ENG-18, ENT-38, GEN-40	09-1512	GEN-175
08-0004	ENG-21, GEN-34	08-0100	ENG-19, GEN-38	09-1513	GEN-175
08-0004I	ENG-21, GEN-34	08-0100I	ENG-19, GEN-38	09-1514	GEN-175
08-0005	ENG-23, GEN-35	08-0100IG	ENG-18, GEN-38	09-1516	GEN-175
08-0007	ENG-24, GEN-36	08-0101	ENG-19, GEN-37	09-1613	GEN-175
08-0007I	ENG-24, GEN-39	08-0101I	ENG-19, GEN-38	09-1614	GEN-175
08-0008	ENG-22, GEN-35	08-0101IG	ENG-18, GEN-38	09-1970	GEN-325
08-0010	ENG-22	08-0104	ENG-18, GEN-37	09-1980	GEN-325
08-0012	ENG-22, GEN-35	08-0105	GEN-37	09-2116	GEN-2
08-0013	ENG-22, GEN-38	08-0105I	ENG-18	09-2118	GEN-2
08-0013IG	ENG-14, GEN-38	08-0108	GEN-38	09-2166	GEN-2
08-0015	ENG-20, GEN-40	08-0120	GEN-40	09-2168	GEN-2
08-0016	ENG-20, GEN-40	08-0120I	ENG-19	09-2485	GEN-2
08-0017	ENG-20, GEN-40	08-0122	ENG-19, GEN-40	09-5011	GEN-172
08-0018	ENG-20, GEN-40	08-0122I	ENG-19, GEN-36	09-5012	GEN-172
08-0019	ENG-20, GEN-40	08-0123	ENG-19, GEN-40	09-5228	ENT-5
08-0020	ENG-18, GEN-37	08-0128	GEN-40	09-5229	ENT-5
08-0022	ENG-20, GEN-40	08-0130	ENG-19, GEN-36	09-5812	GEN-328
08-0022I	GEN-41	08-0143	ENG-17, GEN-38	09-5818	GEN-328
08-0022IG	ENG-20	08-0149	ENG-17, GEN-38	09-5822	GEN-328
08-0023	GEN-40	08-0223	ENG-17, GEN-39	09-5824	GEN-328
08-0023I	ENG-20, GEN-41	08-0300	ENG-17, GEN-39	09-6600	GEN-326
08-0023IG	ENG-20	08-0301	ENG-17, GEN-39	09-7925	GEN-17
08-0024	ENG-20, GEN-40	08-0301I	ENG-17, GEN-40	09-7927	GEN-17
08-0025	ENG-20, GEN-40	08-0303	ENG-17, GEN-39	09-7932	GEN-17
08-0025I	ENG-20, GEN-41	08-0304	GEN-39	09-7935	GEN-17
08-0026	ENG-14, GEN-37	08-0304I	ENG-17	09-7965	GEN-17
08-0026I	ENG-14, ENT-36, GEN-37	08-0306	ENG-17, GEN-39	09-8110	GEN-314
08-0026IG	ENG-14, GEN-37	08-0306I	ENG-17, GEN-40	09-8114	GEN-314
08-0027	ENG-14, GEN-37	08-0307	ENG-17, GEN-39	09-8115	GEN-314
08-0027I	ENG-14, ENT-36, GEN-37	08-0308	ENG-17, GEN-39	09-8303	GEN-317
08-0028I	ENG-18, ENT-38, GEN-40	08-0310	ENG-17, GEN-39	09-8304	GEN-317
08-0030	ENG-18, ENT-38, GEN-40	08-0310I	ENG-17	09-8305	GEN-317
08-0030I	ENG-18, ENT-38, GEN-40	08-0311	ENG-17, GEN-39	09-8306	GEN-317
08-0030IG	ENG-18, GEN-40	08-0311I	ENG-17, GEN-40	09-8307	GEN-317
08-0041	ENG-14, GEN-38	08-0312	ENG-17, GEN-39	09-8308	GEN-317
08-0043	ENG-15, GEN-38	08-0312I	ENG-17, GEN-40	09-8309	GEN-317
08-0043I	ENG-15, GEN-38	08-0313	ENG-17, GEN-39	09-8310	GEN-317
08-0048	ENG-2, GEN-35	08-0313I	ENG-17, GEN-40	09-8311	GEN-317
08-0052	ENG-25, GEN-36	08-0313IG	ENG-17, GEN-40	09-8312	GEN-317
08-0053	ENG-25, GEN-36	08-0319	ENG-17, GEN-39	09-8314	GEN-317
08-0054	ENG-25, GEN-36	08-0509	ENG-19, GEN-36	09-8315	GEN-317
08-0056	ENG-25, GEN-36	08-1130	ENG-22, ENG-65	09-8336	GEN-319
08-0057	ENG-25, GEN-36	09-078-000	O/A-18	09-8337	GEN-319
08-0058	ENG-19, GEN-36	09-142-000	O/A-18	09-8338	GEN-319
08-0061	ENG-19, GEN-36	09-143-000	O/A-18	09-8339	GEN-319
08-0062NS	ENG-19, GEN-37	09-147-000	O/A-17	09-8340	GEN-319
08-0075	ENG-18, GEN-38	09-0514	GEN-175	09-8342	GEN-319
08-0089	ENG-17, GEN-38	09-0515	GEN-175	09-8343	GEN-319
		09-0520	GEN-175	09-8376	GEN-317
		09-1113	GEN-176	09-8377	GEN-317
		09-1114	GEN-176	09-8378	GEN-317
		09-1115	GEN-176	09-8379	GEN-317
				09-8380	GEN-317

09-8381GEN-317	10-006-000O/A-16	10-141-000O/A-18, O/A-54
09-8382GEN-317	10-007-000O/A-16	10-148-000O/A-46
09-8383GEN-317	10-008-000O/A-67	10-149-000O/A-3
09-8500GEN-327	10-010-000O/A-3	10-150-000O/A-3
09-8504GEN-327	10-011-000O/A-108	10-151-000O/A-3
09-8506GEN-315	10-015-000O/A-5	10-152-000O/A-2
09-8507GEN-316	10-016-000O/A-50	10-153-000O/A-2
09-8508GEN-315	10-017-000O/A-67	10-154-000O/A-2
09-8509GEN-315	10-019-000O/A-67	10-155-000O/A-3
09-8510GEN-315	10-020-000	... O/A-46, O/A-51	10-156-000O/A-3
09-8511GEN-321	10-022-000O/A-17	10-157-000O/A-3
09-8520GEN-325, PED-43	10-023-000O/A-56	10-0200IENG-21
09-8599GEN-327	10-054-000O/A-16	10-0201IENG-21
09-8600	... GEN-327, OBE-80	10-055-000O/A-16	10-0321IENG-13
09-8603GEN-318	10-056-000O/A-48	10-0331IENG-13
09-8605GEN-318	10-057-000O/A-42	10-0341IENG-13
09-8607GEN-318	10-058-000O/A-42	10-0351IENG-13
09-8608GEN-318	10-059-000O/A-42	10-0361IENG-13
09-8612GEN-318	10-062-000O/A-56	10-0371IENG-13
09-8614GEN-318	10-063-000O/A-56	10-0381IENG-13
09-8640GEN-327	10-064-000O/A-56	10-0391IENG-13
09-8717GEN-323	10-065-000O/A-56	10-0401IENG-13
09-8730GEN-323	10-066-000O/A-56	10-0411IENG-13
09-8799GEN-323	10-067-000O/A-56	10-0421IENG-13
09-8800GEN-323	10-068-000O/A-56	10-0431IENG-13
09-8823GEN-323	10-069-000O/A-56	10-0441IENG-13
09-8993GEN-318	10-070-000O/A-56	10-0461IENG-13
09-8995GEN-318	10-071-000O/A-56	10-0471IENG-13
09-8996GEN-318	10-072-000O/A-56	10-0481IENG-13
09-8997GEN-318	10-073-000O/A-56	10-0491IENG-13
09-8999GEN-318	10-074-000O/A-56	10-0493IENG-13
09-9001GEN-318	10-075-000O/A-56	10-0812GEN-165
09-9107GEN-318	10-099-000O/A-56	10-0902GEN-153
09-9108GEN-318	10-101-000O/A-56	10-1011ENG-22
09-9109GEN-318	10-102-000O/A-61	10-1011IENG-22
09-9111GEN-318	10-108-000O/A-67	10-1012GEN-171
09-9112GEN-318	10-113-000O/A-18, O/A-54	10-1013GEN-158
09-9505GEN-316	10-114-000O/A-17, O/A-54	10-1021ENG-24
09-9507GEN-316	10-115-000O/A-17, O/A-54	10-1021IENG-24
09-9581CVT-222	10-116-000O/A-31, O/A-54	10-1061ENG-23
09-9602CVT-222	10-117-000O/A-17, O/A-54	10-1061IENG-23
09-9603CVT-222	10-119-000O/A-18, O/A-54	10-1062ENG-23
09-9604CVT-222	10-120-000O/A-18, O/A-54	10-1062IENG-23
09-9605CVT-222	10-121-000O/A-54	10-1081ENG-21
09-9606CVT-222	10-121-010O/A-54	10-1081IENG-21
09-9607CVT-222	10-122-000O/A-54	10-1082ENG-21
09-9608CVT-222	10-123-000O/A-54	10-1082IENG-21
09-9609CVT-222	10-125-000O/A-54	10-1091ENG-25
09-9610CVT-222	10-127-000O/A-54	10-1091IENG-25, ENT-38
09-9611CVT-222	10-127-003O/A-54	10-1160ENG-22
09-9612CVT-222	10-128-000O/A-54	10-1160IENG-22, ENT-36
09-9613CVT-222	10-128-001O/A-54	10-1162ENG-22
09-9619CVT-222	10-129-000	... O/A-54, O/A-70	10-1162IENG-22, ENT-36
10-001-000O/A-108	10-130-000O/A-31, O/A-54	10-1180ENG-22
10-002-000O/A-108	10-132-000O/A-54	10-1180IENG-22, ENT-36
10-003-000O/A-5	10-133-000O/A-54	10-1191ENG-25

10-1191I.....	ENG-25, ENT-38	11-026-000.....	O/A-6
10-1200.....	ENG-24	11-027-000.....	O/A-6
10-1200I.....	ENG-24	11-028-000.....	O/A-6
10-1201.....	ENG-24	11-029-000.....	O/A-63
10-1201I.....	ENG-24	11-030-000.....	O/A-63
10-1202.....	ENG-24	11-031-000.....	O/A-63
10-1202I.....	ENG-24	11-032-000.....	O/A-63
10-1203.....	ENG-24	11-033-000.....	O/A-63
10-1203I.....	ENG-24	11-034-000.....	O/A-63
10-1212.....	GEN-157	11-074-000.....	O/A-17
10-1213.....	GEN-158	11-078-000.....	RET-92
10-1311.....	ENG-12	11-101-000.....	O/A-110
10-1311I.....	ENG-12, ENT-35	11-102-000.....	O/A-110
10-1321.....	ENG-12	11-102.....	ENT-56
10-1321I.....	ENG-12, ENT-35	11-142.....	ENT-56
10-1322.....	ENG-12	11-192.....	ENT-56
10-1322I.....	ENG-12, ENT-35	11-301.....	ENT-98
10-1331.....	ENG-12	11-302.....	ENT-99
10-1331I.....	ENG-12, ENT-35	11-303.....	ENT-99
10-1360.....	ENG-12	11-311.....	ENT-95
10-1360I.....	ENG-12, ENT-35	11-321.....	ENT-95
10-1361.....	ENG-12	11-341.....	ENT-98
10-1361I.....	ENG-12, ENT-35	11-342.....	ENT-99
10-1362.....	ENG-12	11-343.....	ENT-99
10-1362I.....	ENG-12, ENT-35	11-371.....	ENT-100
10-1371.....	ENG-12	11-372.....	ENT-100
10-1371I.....	ENG-12, ENT-35	11-402.....	ENT-99
10-1372.....	ENG-12	11-442.....	ENT-99
10-1372I.....	ENG-12, ENT-35	11-502.....	ENT-100
10-1401.....	ENG-12	11-504.....	ENT-100
10-1401I.....	ENG-12, ENT-35	11-601.....	ENT-13
10-1411.....	ENG-12	11-642S.....	ENT-13
10-1411I.....	ENG-12, ENT-35	11-651.....	ENT-13
10-1412.....	ENG-12	11-691.....	ENT-13
10-1412I.....	ENG-12, ENT-35	11-692S.....	ENT-13
10-1418.....	GEN-165	11-1002.....	NEU-18, SPN-72, SPN-107
10-1421.....	ENG-12	11-1011.....	SPN-72, SPN-107
10-1421I.....	ENG-12, ENT-35	11-1015.....	NEU-110
10-1431.....	ENG-12	11-1019.....	SPN-44, SPN-72, SPN-107
10-1431I.....	ENG-12, ENT-35	11-1020C.....	NEU-111
10-1445.....	ENG-13, ENT-34	11-1021C.....	NEU-111
10-1445I.....	ENG-13, ENT-34	11-2095.....	O/A-2
10-1447.....	ENG-13, ENT-34	11-5530.....	CVT-121, GEN-134
10-1447I.....	ENG-13, ENT-34	11-5531.....	CVT-121, GEN-134
10-1449.....	ENG-13, ENT-34	11-5534.....	CVT-121, GEN-134
10-1449I.....	ENG-13, ENT-34	11-5535.....	CVT-121, GEN-134
10-1481.....	ENG-12	12-001-000.....	O/A-29, O/A-51
10-1481I.....	ENG-13, ENT-35	12-004-000.....	O/A-30, O/A-51
10-1482.....	ENG-13, ENT-34	12-006-000.....	O/A-29
10-1482I.....	ENG-13, ENT-34	12-007-000.....	O/A-30, O/A-51
10-1483.....	ENG-12	12-008-000.....	O/A-31
10-1483I.....	ENG-12, ENT-35	12-009-000.....	O/A-31
10-1484.....	ENG-12	12-010-000.....	O/A-30
10-1484I.....	ENG-12, ENT-35	12-028-000.....	O/A-56
10-1485.....	ENG-12		
10-1485I.....	ENG-12, ENT-35		
10-1486.....	ENG-13, ENT-34		
10-1486I.....	ENG-13, ENT-34		
10-1487.....	ENG-12		
10-1487I.....	ENG-12, ENT-35		
10-1488.....	ENG-13, ENT-34		
10-1488I.....	ENG-13, ENT-34		
10-1501.....	ENG-13		
10-1501I.....	ENG-13		
10-1511.....	ENG-13		
10-1511I.....	ENG-13		
10-1521.....	ENG-13		
10-1521I.....	ENG-13		
10-1531.....	ENG-13		
10-1531I.....	ENG-13		
10-1541.....	ENG-13		
10-1541I.....	ENG-13		
10-1551.....	ENG-13		
10-1551I.....	ENG-13		
10-1561.....	ENG-13		
10-1561I.....	ENG-13		
10-1571.....	ENG-13		
10-1571I.....	ENG-13		
10-1581.....	ENG-13		
10-1581I.....	ENG-13		
10-1813.....	GEN-163		
10-1815.....	GEN-164		
10-1818.....	GEN-164		
10-1819.....	GEN-163		
10-1820.....	GEN-164		
10-1823.....	GEN-164		
10-1828.....	GEN-164, OBE-39		
10-2015.....	GEN-155		
10-2018.....	GEN-155		
10-2020.....	GEN-155		
10-2218.....	GEN-169		
10-3121.....	GEN-159		
11-002-000.....	O/A-51, O/A-63		
11-003-000.....	O/A-51, O/A-63		
11-004-000.....	O/A-51, O/A-63		
11-005-000.....	O/A-51, O/A-63		
11-006-000.....	O/A-51, O/A-63		
11-007-000.....	O/A-51, O/A-63		
11-008-000.....	O/A-51, O/A-63		
11-009-000.....	O/A-51, O/A-63		
11-012-000.....	O/A-77		
11-013-000.....	O/A-77		
11-014-000.....	O/A-77		
11-015-000.....	O/A-77		
11-016-000.....	O/A-77		
11-017-000.....	O/A-77		
11-018-000.....	O/A-77		
11-019-000.....	O/A-77		
11-020-000.....	O/A-63		
11-021-000.....	O/A-63		
11-022-000.....	O/A-63		
11-025-000.....	O/A-6		

12-029-000.....O/A-29, O/A-51	13-1010.....SPN-111	15-0531.....CVT-23
12-030-000.....O/A-30, O/A-51	13-1011.....SPN-111	15-0536.....CVT-23
12-031-000.....O/A-30, O/A-51	13-1012.....SPN-111	15-0540.....CVT-23
12-1005C.....SPN-72, SPN-107	13-1013.....SPN-111	15-0541.....CVT-23
12-1006C.....SPN-72, SPN-107	13-1034.....SPN-99	15-0550.....CVT-23
12-1007.....NEU-19, SPN-46, SPN-72, SPN-107	13-1054.....SPN-122	15-0551.....CVT-23
12-5382.....LAP-26	13-1055.....SPN-122	15-0730.....CVT-23
12-5383.....LAP-25	13-1056.....SPN-122	15-0731.....CVT-23
12-5384.....LAP-26	13-1057.....SPN-122	15-0735.....CVT-23
12-5391.....LAP-27	13-1065.....SPN-99	15-0736.....CVT-23
12-5392.....LAP-26	13-1066.....SPN-99	15-0740.....CVT-23
12-5393.....LAP-25	13-6101.....GEN-172	15-0741.....CVT-23
12-5394.....LAP-26	13-6102.....GEN-172	15-0750.....CVT-23
13-001-000....O/A-91, RET-95	13-6103.....GEN-172	15-0751.....CVT-23
13-002-000.....O/A-56	13-6104.....GEN-172	15-1000C.....NEU-17
13-003-000.....O/A-56	13-6201.....GEN-172	15-1004.....NEU-19
13-004-000.....O/A-56	13-6202.....GEN-172	15-1005.....NEU-17
13-005-000.....O/A-56	13-6203.....GEN-172	15-1006.....NEU-17
13-006-000.....O/A-56	13-6204.....GEN-172	15-1007.....NEU-17
13-023-000....O/A-52, O/A-89, RET-92, RET-94	13-7042.....GEN-73	15-1008.....NEU-17
13-024-000....O/A-52, O/A-89, RET-92, RET-94	14-001-000.....O/A-29	15-1530.....CVT-23
13-025-000....O/A-52, O/A-89, RET-92, RET-94	14-016-000.....O/A-2	15-1535.....CVT-23
13-026-000....O/A-52, O/A-89, RET-92, RET-94	14-039-000.....O/A-41	15-2014.....GEN-55
13-027-000....O/A-52, O/A-89, RET-92, RET-94	14-0609.....GEN-295	15-2414.....GEN-27
13-028-000....O/A-52, RET-92	14-0610.....GEN-295	15-2514.....GEN-27
13-029-000....O/A-52, O/A-89, RET-92, RET-94	14-0612.....GEN-295	15-2914.....GEN-29
13-030-000...O/A-52, O/A-89, RET-94	14-1000.....NEU-19	15-3009.....GEN-28
13-031-000....O/A-52, RET-92	14-1020.....NEU-110	15-3109.....GEN-28
13-035-000....O/A-90, RET-95	14-1021.....NEU-110	15-3209.....GEN-68
13-036-000....O/A-90, RET-95	14-1025.....NEU-110	15-3309.....GEN-68
13-037-000....O/A-90, RET-95	14-1043.....SPN-43, SPN-72, SPN-107	15-3501.....GEN-67
13-038-000....O/A-90, RET-95	14-1044.....SPN-43, SPN-72, SPN-107	15-3502.....GEN-67
13-039-000....O/A-90, RET-95	14-2009.....GEN-308	15-4002.....GEN-66
13-040-000...O/A-90, RET-95	14-2312.....GEN-308	15-4012.....GEN-67
13-041-000...O/A-90, RET-95	14-2410.....GEN-308	15-4082.....GEN-67
13-042-000....O/A-90, RET-95	14-2610.....GEN-256	15-4112.....GEN-67
13-045-000.....RET-92	14-3030.....O/A-113	15-4182.....GEN-67
13-045-001.....RET-92	14-4600.....GEN-174	15-4412.....GEN-66
13-045-002.....RET-92	14-4805.....GEN-107	15-4512.....GEN-66
13-045-003.....RET-92	14-5000.....GEN-174	15-4582.....GEN-67
13-045-004.....RET-92	14-5065.....O/A-110	15-4612.....GEN-66
13-045-008.....RET-92	14-5620.....GEN-174	15-4612.....GEN-66
13-047-000.....O/A-56	14-5635.....O/A-112	15-4712.....GEN-66
13-0004.....CVT-121	15-002-000.....O/A-105	15-5014.....GEN-67
13-1004C.....NEU-50, SPN-67	15-003-000.....O/A-101	15-5114.....GEN-67
13-1005C.....NEU-53, SPN-67	15-043-101.....O/A-47	15-5615.....GEN-30
13-1008.....SPN-111	15-0430.....CVT-23	15-5715.....GEN-30
13-1009.....SPN-111	15-0431.....CVT-23	15-7014.....GEN-30
	15-0435.....CVT-23	15-7016.....GEN-30
	15-0436.....CVT-23	15-7114.....GEN-30
	15-0440.....CVT-23	15-7116.....GEN-30
	15-0441.....CVT-23	15-7214.....GEN-30
	15-0450.....CVT-23	15-7216.....GEN-30
	15-0451.....CVT-23	15-7284.....GEN-29
		15-7286.....GEN-29
		15-7314.....GEN-30
		15-7316.....CVT-74, GEN-30

- 15-7384 CVT-73, GEN-29
 15-7386 GEN-29
 15-8216 GEN-31
 15-8316 GEN-31
 15-8416 GEN-31
 15-8420 GEN-31
 16-1014 GEN-59
 16-1016 GEN-59
 16-1018 GEN-59
 16-1020 GEN-59
 16-1022 GEN-59
 16-1024 GEN-59
 16-1026 GEN-59
 16-1030 GEN-59
 16-1114 GEN-59
 16-1116 GEN-59
 16-1118 GEN-59
 16-1120 GEN-59
 16-1122 GEN-59
 16-1124 GEN-59
 16-1126 GEN-59
 16-1128 GEN-59
 16-1130 GEN-59
 16-1140 GEN-59
 16-1145 GEN-59
 16-1214 GEN-55
 16-1216 GEN-58
 16-1218 GEN-58
 16-1220 GEN-58
 16-1222 GEN-58
 16-1224 GEN-58
 16-1226 GEN-58
 16-1228 GEN-58
 16-1240 GEN-58
 16-1245 GEN-58
 16-1314 GEN-55
 16-1316 GEN-58
 16-1318 GEN-58
 16-1320 GEN-58
 16-1322 GEN-58
 16-1324 GEN-58
 16-1326 GEN-58
 16-1328 GEN-58
 16-1330 GEN-58
 16-1340 GEN-58
 16-1345 GEN-58
 16-1519 GEN-27
 16-1520 GEN-27
 16-1524 CVT-73, GEN-27
 16-3616 CVT-73, GEN-27
 16-3716 CVT-73, GEN-27
 16-3720 CVT-73, GEN-27
 16-3723 CVT-73, GEN-27
 16-3727 CVT-74, GEN-27
 16-3816 GEN-3
 16-3819 GEN-3
 16-3916 GEN-3
 16-3921 GEN-68
 16-4019 CVT-72, GEN-27
 16-4021 CVT-72, GEN-27
 16-4025 CVT-72, GEN-28
 16-4088 CVT-93, GEN-65
 16-4118 CVT-72, GEN-27
 16-4119 CVT-72, GEN-27
 16-4121 CVT-72, GEN-27
 16-4188 CVT-93, GEN-65
 16-4189 CVT-93, GEN-65
 16-4218 CVT-84, GEN-52
 16-4318 CVT-84, GEN-52
 16-5024 CVT-74, GEN-28
 16-5123 CVT-115, GEN-27
 16-5124 CVT-74, GEN-28
 16-5190 CVT-74, GEN-28
 16-5194 CVT-74, GEN-28
 16-6519 GEN-42
 16-6761 CVT-78, GEN-43
 16-8021 CVT-74, GEN-30
 16-9100 GEN-5
 17-0514 CVT-88
 17-0519 GEN-52
 17-0619 CVT-88
 17-0723 CVT-119, GEN-101
 17-0736 CVT-75, GEN-29
 17-0740 CVT-75, GEN-29
 17-0770 CVT-75, GEN-29
 17-0775 GEN-42
 17-0820 GEN-101
 17-0830 GEN-101
 17-0840 GEN-101, OBE-29
 17-0845 GEN-101, OBE-29
 17-1219 GEN-101
 17-1222 GEN-101
 17-1225 GEN-101
 17-1228 GEN-101
 17-2150 CVT-120, GEN-106
 17-2151 GEN-106
 17-2154 GEN-116
 17-2155 GEN-106
 17-2156 GEN-106
 17-2157 GEN-106, OBE-23
 17-3415 GEN-103
 17-3420 GEN-103
 17-3615 GEN-91
 17-3620 GEN-91
 17-3650 GEN-91
 17-3665 GEN-91
 17-3670 GEN-91
 17-3671 GEN-91, OBE-28
 17-5008 GEN-13
 17-5508 GEN-12
 17-5510 GEN-12
 17-5513 GEN-12
 17-5714 GEN-13
 17-5715 GEN-13
 17-5783 GEN-14
 17-5800 GEN-13
 17-7216 GEN-14
 17-7218 GEN-14
 17-7220 GEN-14
 17-7280 GEN-15
 17-7281 GEN-15
 17-7282 GEN-15
 17-7283 GEN-16
 17-7284 GEN-16
 17-7285 GEN-16
 18-1010 SPN-3
 18-1011 ... O/A-4, OBE-2, SPN-4
 18-1013 SPN-3
 18-1014 SPN-6
 19-1016 GEN-13
 19-4000 CVT-54, GEN-5
 19-4001 CVT-54, GEN-5
 19-4004 CVT-18, GEN-5,
 OBGYN-2
 19-4012 GEN-14
 19-4018 GEN-10
 19-4060 GEN-9, OBE-5
 19-4061 GEN-9, OBE-5
 19-4062 GEN-9, OBE-5
 19-4063 CVT-34, GEN-10,
 OBE-6
 19-4133 GEN-15
 19-4137 GEN-14
 19-4141 GEN-14
 19-4146 GEN-13
 19-5017 GEN-72
 19-5018 GEN-72
 19-5024 GEN-71
 19-5029 GEN-71
 19-5029E GEN-72
 19-5030 GEN-71
 19-5031 GEN-72
 19-5040 GEN-71
 19-5045 GEN-71
 19-5118 GEN-72
 19-5124 GEN-71
 19-5129 GEN-72
 19-5224 GEN-71
 19-5324 GEN-71
 19-5424 GEN-71
 19-5515 GEN-11
 19-5524 GEN-71
 19-5579. CVT-28, GEN-6, PED-3
 19-5580 CVT-31, GEN-7
 19-5581 CVT-31, GEN-7
 19-5582. CVT-31, GEN-7, OBE-4
 19-5583 CVT-31, GEN-54, OBE-4
 19-5824 GEN-71

19-5924.....	GEN-71	CVT-183, ENT-109, GEN-235, O/A-86, RET-58, SPN-99	20-1082KI	ENG-8, ENT-39
19-8010.....	CVT-47, GEN-15	20-0510	20-1090	ENG-11
19-8026	CVT-28, CVT-97, GEN-75	20-0525	20-1090I.....	ENG-11, ENT-42
19-8027.....	CVT-44, GEN-75, PED-5	20-0526	20-1090IMT	ENG-11, ENT-42
19-8029	CVT-44, PED-5	20-0540.....	20-1090K.....	ENG-11
19-8071	CVT-22	20-0707	20-1090KI	ENG-11, ENT-42
19-8080	CVT-22	20-0708.....	20-1160	ENG-9
19-8090	CVT-20	20-0930.....	20-1160I	ENG-9
19-8091.....	CVT-20	20-1001.....	20-1160K	ENG-9
19-8092	CVT-20	20-1002	20-1160KI.....	ENG-9
19-8093	CVT-20	20-1003	20-1162	ENG-9
19-8094	CVT-20	20-1004	20-1162I.....	ENG-9
19-8095	CVT-20	20-1005	20-1162K.....	ENG-9
19-8097.....	CVT-21	20-1006	20-1162KI	ENG-9
19-8099	CVT-21	20-1010I	20-1180	ENG-9, ENT-42
19-8104.....	CVT-25, OBE-4	20-1010K	20-1180I	ENG-9, ENT-42
19-8126	GEN-44	20-1010KI.....	20-1180K.....	ENG-9, ENT-42
19-8145	CVT-46, GEN-12	20-1010-OL	20-1180KI.....	ENG-9, ENT-42
19-8146 .	CVT-46, GEN-7, OBE-7	20-1020	20-1190	ENG-11
19-8147	CVT-46, GEN-12, OBE-7	20-1020I.....	20-1190I	ENG-11, ENT-42
19-8150	CVT-33, CVT-45, GEN-11, PED-5, RET-144	20-1020K	20-1190K	ENG-11
19-8152	CVT-46, GEN-12, OBE-7	20-1020KI	20-1190KI.....	ENG-11, ENT-42
19-8167	CVT-18	20-1030	20-1200	ENG-11
20-103	GEN-215	20-1030I.....	20-1200I.....	ENG-11
20-302.....	O/A-75	20-1030K	20-1200K	ENG-11
20-342.....	O/A-75	20-1030KI	20-1200KI	ENG-11
20-0311.....	ENG-7	20-1040	20-1201	ENG-11
20-0311R	ENG-7	20-1040I.....	20-1201I	ENG-11
20-0321	ENG-7	20-1040K.....	20-1201K.....	ENG-11
20-0321R	ENG-7	20-1040KI.....	20-1201KI.....	ENG-11
20-0331	ENG-7	20-1060	20-1203	ENG-10
20-0331R.....	ENG-7	20-1060I.....	20-1203I.....	ENG-10
20-0351	ENG-7	20-1060IMT	20-1203K	ENG-10
20-0361	ENG-7	20-1060K.....	20-1203KI	ENG-10
20-0361R.....	ENG-7	20-1060KI	20-1315	ENG-3
20-0371	ENG-7	20-1070.....	20-1315I.....	ENG-3, ENT-40
20-0371R	ENG-7	20-1070I.....	20-1315IMT	ENG-6, ENT-40
20-0381	ENG-7	20-1070K	20-1315K.....	ENG-3, ENT-40
20-0381R.....	ENG-7	20-1070KI	20-1315KI	ENG-3, ENT-40
20-0411.....	ENG-7	20-1080	20-1320I.....	ENG-3, ENT-40
20-0411R	ENG-7	20-1080I.....	20-1320IMT	ENG-6, ENT-40
20-0421	ENG-7	20-1080K.....	20-1320K	ENG-3, ENT-40
20-0421R.....	ENG-7	20-1080KI	20-1320KI	ENG-3, ENT-40
20-0431	ENG-7	20-1082.....	20-1320-OL.....	ENG-3
20-0431R.....	ENG-7	20-1082I.....	20-1325	ENG-3
20-0481	ENG-7	20-1082I.....	20-1325I	ENG-3, ENT-40
20-0481R.....	ENG-7	20-1082IMT	20-1325IMT....	ENG-6, ENT-40
20-0491	ENG-7	20-1082KI	20-1325K	ENG-3, ENT-40
20-0491R.....	ENG-7	20-1082I.....	20-1325KI.....	ENG-3, ENT-40
20-0508.....	CVT-183, ENT-109, GEN-235, O/A-86, RET-58, SPN-99	20-1082I.....	20-1330.....	ENG-3
20-0509.....	CVT-183, ENT-109, GEN-235, O/A-86, RET-58, SPN-99	20-1082I.....	20-1330I	ENG-3, ENT-40
		20-1082IMT	20-1330IMT	ENG-6, ENT-40
		20-1082K	20-1330K	ENG-3, ENT-40
			20-1330KI	ENG-3, ENT-40
			20-1340	ENG-3
			20-1340I.....	ENG-3, ENT-41

20-1340K	ENG-3	20-1415I	ENG-4	20-1550I	ENG-6, ENT-39
20-1340KI	ENG-3, ENT-41	20-1415IMT	ENG-6	20-1550K	ENG-6
20-1350	ENG-5	20-1415K	ENG-4	20-1550KI	ENG-6, ENT-39
20-1350I	ENG-5	20-1415KI	ENG-4	20-1560	ENG-6
20-1350K	ENG-5	20-1420	ENG-4	20-1560I	ENG-6
20-1350KI	ENG-5	20-1420I	ENG-4	20-1560K	ENG-6
20-1355	ENG-3	20-1420IMT	ENG-6	20-1560KI	ENG-6, ENT-39
20-1355I	ENG-3, ENT-41	20-1420K	ENG-4	20-1570	ENG-6, ENT-39
20-1355K	ENG-3	20-1420KI	ENG-4	20-1570I	ENG-6, ENT-39
20-1355KI	ENG-3, ENT-41	20-1440	ENG-4	20-1570K	ENG-6, ENT-39
20-1360	ENG-3	20-1440I	ENG-4	20-1570KI	ENG-6, ENT-39
20-1360I	ENG-3, ENT-41	20-1440IMT	ENG-6	20-1580	ENG-6, ENT-39
20-1360K	ENG-3	20-1440K	ENG-4	20-1580I	ENG-6
20-1360KI	ENG-3, ENT-41	20-1440KI	ENG-4	20-1580K	ENG-6, ENT-39
20-1370	ENG-3	20-1445	ENG-4	20-1580KI	ENG-6
20-1370I	ENG-3, ENT-41	20-1445I	ENG-4	20-1682I	ENG-6, ENT-40
20-1370K	ENG-3	20-1445K	ENG-4	20-1682KI	ENG-6
20-1370KI	ENG-3, ENT-41	20-1445KI	ENG-4	20-1682KI-28	ENT-40
20-1375	ENG-3	20-1480	ENG-5	20-1708	ENT-117
20-1375I	ENG-3, ENT-41	20-1480I	ENG-5	20-1710	ENT-117, GEN-251, NEU-84
20-1375K	ENG-3	20-1480IMT	ENG-6	20-1712	ENT-117, GEN-251, NEU-84
20-1375KI	ENG-3, ENT-41	20-1480K	ENG-5	20-1714	ENT-117, GEN-251, NEU-84
20-1380	ENG-4	20-1480KI	ENG-5	20-1716	ENT-117
20-1380I	ENG-3, ENT-41	20-1481	ENG-5	20-1718	ENT-117, GEN-251, NEU-84, OBE-67
20-1380IMT	ENG-6, ENT-40	20-1481I	ENG-5	20-1728	GEN-251
20-1380K	ENG-4	20-1481K	ENG-5	20-1730	GEN-251, NEU-84
20-1380KI	ENG-4, ENT-41	20-1481KI	ENG-5	20-1732	GEN-251, NEU-84
20-1381I	ENG-7, ENT-41	20-1484	ENG-5	20-1736	GEN-251, NEU-84
20-1381KI	ENG-7	20-1484I	ENG-5	20-1750	GEN-219, RET-159
20-1381KI-28	ENT-41	20-1484K	ENG-5	20-1752	GEN-219, NEU-84, RET-159
20-1382	ENG-4	20-1484KI	ENG-5	20-1776	GEN-224, O/A-89, RET-91
20-1382I	ENG-4, ENT-41	20-1486	ENG-5	20-1777	GEN-224, O/A-89, RET-91
20-1382IMT	ENG-6, ENT-40	20-1486I	ENG-5	20-1782	GEN-250, RET-148
20-1382K	ENG-4	20-1486K	ENG-5	20-1788	O/A-25, SPN-53
20-1382KI	ENG-4, ENT-41	20-1486KI	ENG-5	20-1814	GEN-237, RET-133
20-1384	ENG-4	20-1500	ENG-5	20-2010	RET-97
20-1384I	ENG-4, ENT-41	20-1500I	ENG-5	20-2011	RET-50
20-1384IMT	ENG-6, ENT-40	20-1500K	ENG-5	20-2040	GEN-126
20-1384K	ENG-4	20-1500KI	ENG-5	20-2057	GEN-126, NEU-49
20-1384KI	ENG-4	20-1510	ENG-5	20-2081	NEU-128
20-1386	ENG-4	20-1510I	ENG-5	20-2082	NEU-128
20-1386I	ENG-4, ENT-41	20-1510K	ENG-5	20-2083	NEU-128
20-1386IMT	ENG-6, ENT-40	20-1510KI	ENG-5	20-2084	NEU-128
20-1386K	ENG-4	20-1520	ENG-5	20-2085	NEU-128
20-1386KI	ENG-4	20-1520I	ENG-5	20-2086	NEU-128
20-1400	ENG-4	20-1520K	ENG-5	20-2201	GEN-127, NEU-48
20-1400I	ENG-4	20-1520KI	ENG-5	20-2202	GEN-127, NEU-48
20-1400IMT	ENG-6	20-1530	ENG-6	20-2203	GEN-127
20-1400K	ENG-4	20-1530I	ENG-6, ENT-39	20-2231	ENT-68, GEN-127,
20-1400KI	ENG-4	20-1530K	ENG-6		
20-1410	ENG-4	20-1530KI	ENG-6, ENT-39		
20-1410I	ENG-4	20-1540	ENG-6		
20-1410IMT	ENG-6	20-1540I	ENG-6, ENT-39		
20-1410K	ENG-4	20-1540K	ENG-6		
20-1410KI	ENG-4	20-1540KI	ENG-6		
20-1415	ENG-4	20-1550	ENG-6		

NEU-48, NEU-46	20-6452..... ENT-115, GEN-215, RET-49	22-0070I.....NEU-124
20-2232.....ENT-68, GEN-127, NEU-46	20-6453..... ENT-115, GEN-215, RET-49	22-0073.....NEU-124
20-2236.....GEN-127	20-6502.....ENT-71, GEN-126	22-0073I.....NEU-124
20-2650K.....ENG-26	20-6552..... ENT-115, GEN-215, RET-49	22-0101.....GEN-235, RET-67
20-2722.....ENT-65, GEN-126, NEU-44	20-6553..... ENT-115, GEN-215, RET-49	22-0251..... GEN-231, RET-55, SPN-99
20-2723.....ENT-65, GEN-126, NEU-44	20-8020.....ENG-57	22-0252..... CVT-170, GEN-231, OBE-50, RET-55, SPN-99
20-2723E..... GEN-126	20-8040.....ENG-57	22-0253..... CVT-170, GEN-231, OBE-50, RET-55, SPN-99
20-2920HK..... ENG-26	20-8078.....NEU-128	22-0254..... CVT-170, GEN-231, OBE-50, RET-55, SPN-99
20-2920K..... ENG-26	20-8079.....NEU-128	22-0255..... CVT-170, GEN-231, OBE-50, RET-55, SPN-99
20-2960HK..... ENG-26	20-8080.....NEU-128	22-0256..... CVT-170, GEN-231, OBE-50, RET-55, SPN-99
20-3012.....GEN-127	21-1001. CVT-57, SPN-9, SPN-72, SPN-107, SS-38	22-0257..... CVT-170, GEN-231, OBE-50, RET-55, SPN-99
20-3019..... GEN-128	21-1002..... NEU-17	22-0258..... CVT-170, GEN-231, OBE-50, RET-55, SPN-99
20-3020..... GEN-128	21-1002C.....NEU-5	22-0259..... CVT-170, GEN-231, OBE-50, RET-55, SPN-99
20-3113..... GEN-129	21-1003..... SPN-11, SS-43	22-1012.....RET-43
20-3501..... ENT-69, GEN-127	21-1020 .O/A-12, SPN-11, SS-44	22-1015.....GEN-222, RET-43
20-3532.....ENT-69, GEN-129	21-1022..... SPN-11, SS-43	22-1215..... GEN-218, O/A-79, RET-44
20-4014..... ENT-107, GEN-117	21-2500..O/A-10, SPN-9, SS-38	22-1413..... GEN-230, O/A-84, RET-54
20-4015..... ENT-70, GEN-250, RET-149	21-3000..... CVT-60, SS-44	22-1418.....CVT-182, GEN-230 , RET-54, O/A-84
20-4016..... ENT-70, RET-45	21-3001..... CVT-60, SS-44	22-1516..... GEN-230, RET-54
20-4201.....OBGYN-53	21-3002..... CVT-60, SS-44	22-1551..... O/A-87, RET-59
20-4201E.....OBGYN-28	21-4002.....CVT-62, SS-47	22-1552..... O/A-87, RET-59
20-4203.....OBGYN-53	21-4003..... CVT-221, GEN-312, SS-46	22-1553..... O/A-87, RET-59
20-4204.....OBGYN-53	21-8000.....CVT-56, SS-37	22-1554..... O/A-87, RET-59
20-4460..... GEN-234, RET-58	21-8005..... CVT-56, SS-43	22-1555..... O/A-87, RET-59
20-4803..... GEN-129	21-8010.....CVT-56, SS-37	22-1556..... O/A-87, RET-59
20-4805..... GEN-129	21-8011.....CVT-178	22-1614.....GEN-234, O/A-86, RET-57
20-4807.....GEN-129	21-8015..... CVT-59, SS-43	22-1615.....GEN-234, O/A-86, RET-57
20-5001..... ENT-69, GEN-128	22-0006..... CVT-170, GEN-231, OBE-50, RET-55, SPN-99	22-1616.....GEN-234, O/A-86, RET-57
20-5002.....GEN-125	22-0012..... CVT-170, GEN-231, OBE-50, RET-55, SPN-99	22-1821..... GEN-236, O/A-87, RET-61
20-5003..... GEN-68	22-0017..... CVT-170, GEN-231, OBE-50, RET-55, SPN-99	22-2001.....RET-49
20-5005..... ENT-69, GEN-125	22-0025..... GEN-231, RET-55, SPN-99	22-2002..... RET-75
20-5007..... ENT-69, GEN-125	22-0027..... CVT-170, GEN-231, OBE-50, RET-55, SPN-99	22-2003..... RET-75
20-5010..... ENT-69, GEN-125	22-0035..... GEN-231, RET-55, SPN-99	22-2004.....RET-49
20-5012.....ENT-68, GEN-126	22-0051.....NEU-124	22-2005.....RET-98
20-5109.....ENT-69, GEN-128	22-0051I.....NEU-124	22-2006..... RET-75
20-5202.....ENT-64, GEN-124	22-0054.....NEU-124	22-2007..... RET-75
20-5210..... GEN-128	22-0054I.....NEU-124	22-2008..... RET-97
20-5211..... GEN-128	22-0057..... RET-76	22-2043.....RET-53
20-5516..... ENT-108, GEN-227, RET-52	22-0057I.....NEU-124	22-2044.....RET-53
20-5517..... ENT-108, GEN-227, RET-52	22-0060.....NEU-124	22-2535..... GEN-140
20-6001..... GEN-230, RET-98	22-0060I.....NEU-124	
20-6002..... GEN-230, RET-98	22-0063.....NEU-124	
20-6003..... GEN-230, RET-98	22-0063I.....NEU-124	
20-6004..... GEN-230, RET-98	22-0070..... RET-76	
20-6101.....RET-97		
20-6102.....GEN-230, RET-97		
20-6103.....GEN-230, RET-97		
20-6104.....GEN-230, RET-97		
20-6402..... ENT-70, GEN-129		
20-6403..... ENT-68, RET-149		

- 22-2602 GEN-215, O/A-88,
RET-42
- 22-2603 GEN-215, O/A-88,
RET-42
- 22-2604 GEN-215, O/A-88,
RET-42
- 22-2606 GEN-215, O/A-88,
RET-42
- 22-2702 RET-42
- 22-2703 O/A-88, RET-42
- 22-2704 O/A-88, RET-42
- 22-2706 O/A-88, RET-42
- 22-3402 ENT-109, GEN-236,
RET-61, RET-68, O/A-88
- 22-3403 ENT-109, GEN-236,
RET-61, RET-68, O/A-88
- 22-3404 ENT-109, GEN-236,
RET-61, RET-68, O/A-88
- 22-3406 ENT-109, GEN-236,
RET-61, RET-68, O/A-88
- 22-3502 ENT-109, GEN-236,
RET-61, RET-68, O/A-88
- 22-3503 ENT-109, GEN-236,
RET-61, RET-68, O/A-88
- 22-3504 ENT-109, GEN-236,
RET-61, RET-68, O/A-88
- 22-3506 ENT-109, GEN-236,
RET-61, RET-68, O/A-88
- 22-3600 RET-74
- 22-3604 RET-68
- 22-5002 ENT-108
- 22-5004 ENT-108, GEN-229,
O/A-83, RET-53
- 22-5006 ENT-108, GEN-229,
O/A-83, RET-53
- 22-5102 ENT-108
- 22-5103 ENT-108, GEN-229,
O/A-83, RET-53
- 22-5104 ENT-108, GEN-229,
O/A-83, RET-53
- 22-5106 ENT-108, GEN-229,
O/A-83, RET-53
- 22-5806 O/A-87, RET-55
- 22-7002 GEN-229, O/A-84,
RET-54
- 22-7204 GEN-225, O/A-81,
RET-50
- 22-7205 GEN-225, O/A-81,
RET-50
- 22-7206 GEN-225, O/A-81,
RET-50
- 23-0279 O/A-26
- 23-0290 O/A-26
- 23-0306 ENT-116, GEN-227,
O/A-83, RET-147
- 23-0710 GEN-227, O/A-83,
RET-52
- 23-0713 RET-52
- 23-0716 RET-52
- 23-1000 OBE-10, SPN-37
- 23-1001 OBE-10, SPN-37
- 23-1002 OBE-10, SPN-37
- 23-1013 NEU-10, SPN-17
- 23-1014 NEU-10, SPN-17
- 23-1015 NEU-10, SPN-17
- 23-1020C SPN-17, SPN-73
- 23-1021C SPN-17
- 23-1035 SPN-25
- 23-1036 SPN-25
- 23-1041 SPN-27
- 23-1042 SPN-27
- 23-1043 SPN-27
- 23-1044 SPN-27
- 23-1045 SPN-27
- 23-1046 SPN-27
- 23-1047 SPN-27
- 23-1048 SPN-27
- 23-1049 SPN-27
- 23-1051 SPN-27
- 23-1052 SPN-27
- 23-1053 SPN-27
- 23-1054 SPN-27
- 23-1055 SPN-27
- 23-1056 SPN-27
- 23-1057 SPN-27
- 23-1058 SPN-27
- 23-1059 SPN-27
- 23-1061 SPN-28
- 23-1062 SPN-28
- 23-1063 SPN-28
- 23-1064 SPN-28
- 23-1065 SPN-28
- 23-1066 SPN-28
- 23-1067 SPN-28
- 23-1068 SPN-28
- 23-1069 SPN-28
- 23-1081 OBE-19, SPN-25
- 23-1082 OBE-19, SPN-25
- 23-1083 OBE-19, SPN-25
- 23-1084 OBE-19, SPN-25
- 23-1085 OBE-19, SPN-25
- 23-1086 OBE-19, SPN-25
- 23-1087 OBE-19, SPN-25
- 23-1088 OBE-19, SPN-25
- 23-1089 OBE-19, SPN-25
- 23-1266 SPN-45
- 23-1267 SPN-45
- 23-1268 SPN-45
- 23-1501 GEN-234, O/A-86,
RET-58
- 23-1502 GEN-234, O/A-86,
RET-58
- 23-1503 GEN-234, O/A-86,
RET-58
- 23-2570 O/A-15, OBE-9,
SPN-34
- 23-2571 O/A-15, OBE-9, SPN-34
- 23-2572 O/A-15, OBE-9, SPN-34
- 23-2573 O/A-15, OBE-9, SPN-34
- 23-2574 O/A-15, OBE-9, SPN-34
- 23-2575 O/A-15, SPN-34
- 23-2576 O/A-15, OBE-9,
SPN-34
- 23-2577 O/A-15, OBE-9, SPN-34
- 23-2578 O/A-15, OBE-9,
SPN-34
- 23-3512 ENT-116, GEN-223,
RET-147
- 23-3752 GEN-223, RET-50
- 23-4501 GEN-232, O/A-85,
RET-56
- 23-4502 GEN-232, O/A-85,
RET-56
- 23-4503 GEN-232, O/A-85,
RET-56
- 23-4504 GEN-232, O/A-85,
RET-56
- 23-4505 GEN-232, O/A-85,
RET-56
- 23-4511 GEN-232, O/A-85,
RET-56
- 23-4512 GEN-232, O/A-85,
RET-56
- 23-4513 O/A-85
- 23-4514 GEN-232, O/A-85,
RET-56
- 23-4515 GEN-233, O/A-85,
RET-57
- 23-4516 GEN-233, O/A-85,
RET-57
- 23-4517 GEN-233, O/A-85,
RET-57
- 23-4518 GEN-233, O/A-85,
RET-57
- 23-4520 GEN-233, O/A-85,
RET-57
- 23-4550 GEN-233, O/A-86,
RET-57
- 23-4551 GEN-233, O/A-86,
RET-57
- 23-4552 GEN-233, O/A-86,
RET-57
- 23-4701 GEN-226, O/A-82,
OBE-49, RET-51
- 23-4702 GEN-226, O/A-82,
OBE-49, RET-51
- 23-4703 GEN-226, O/A-82,
OBE-49, RET-51

23-4704..... O/A-82	23-7213..... GEN-220, RET-47	24-1320..... ENT-112, GEN-239, NEU-82, RET-107
23-4711..... GEN-226, O/A-82, OBE-49, RET-51	23-7214..... GEN-220, RET-47	24-1321..... ENT-112, GEN-239, NEU-82, RET-107
23-4712..... GEN-226, O/A-82, OBE-49, RET-51	23-7215..... GEN-220, RET-47	24-1500..... LAP-39
23-4713..... GEN-226, O/A-82, OBE-49, RET-51	23-7216..... GEN-220, RET-47	24-1800..... GEN-209, LAP-22, RET-72
23-4714..... GEN-226, O/A-82, OBE-49, RET-51	23-7217..... GEN-220, RET-43	24-1800R..... GEN-210, LAP-22
23-4715..... GEN-226, O/A-82, OBE-49, RET-51	23-7218..... GEN-220, RET-47	24-2000..... GEN-243, RET-93
23-4716..... GEN-226, O/A-82, OBE-49, RET-51	23-7221..... GEN-220, RET-47	24-2000C..... GEN-243, RET-93
23-4717..... GEN-226, O/A-82, OBE-49, RET-51	23-7225..... GEN-220, RET-43	24-2000CW..... GEN-243, RET-93
23-4718..... GEN-226, O/A-82, OBE-49, RET-51	23-7244..... GEN-220, RET-47	24-2004..... GEN-243, RET-93
23-5500..... OBGYN-9	23-7500..... GEN-220	24-2004A..... GEN-242, RET-93
23-5501..... OBGYN-9	23-7501..... GEN-220	24-2005..... GEN-242, RET-93
23-5502..... OBGYN-9	23-7502..... GEN-220	24-2005A..... GEN-242, RET-93
23-5503..... OBGYN-9	23-7503..... GEN-220	24-2009..... GEN-242, RET-93
23-5504..... OBGYN-9	23-7504..... GEN-220	24-2009A..... GEN-242, RET-93
23-5505..... OBGYN-9	23-7505..... GEN-220	24-2009M..... RET-93
23-5532..... OBGYN-8	23-7507..... GEN-220	24-2010..... GEN-242, RET-93
23-5533..... OBGYN-8	23-7508..... GEN-220	24-2010A..... GEN-242, RET-93
23-5534..... OBGYN-8	23-7522..... RET-46	24-2011..... GEN-242, RET-93
23-5535..... OBGYN-8	24-0300..... GEN-249, RET-67	24-2012..... GEN-242, RET-93
23-5536..... OBGYN-8	24-0301..... ENT-113, GEN-249, O/A-92, PED-30, RET-67	24-2014..... RET-93
23-5537..... OBGYN-8	24-0301-H..... PED-30	24-2016A..... RET-93
23-5538..... OBGYN-8	24-0302..... ENT-113, GEN-249, O/A-92, RET-67	24-2017..... RET-93
23-5539..... OBGYN-8	24-0302-H..... PED-30	24-2019..... GEN-242
23-5541..... OBGYN-8	24-0303..... ENT-113, GEN-249, O/A-92, PED-30, RET-67	24-2019A..... GEN-242, RET-93
23-5542..... OBGYN-8	24-0304..... ENT-113, GEN-249, O/A-92, RET-67	24-2020..... GEN-242
23-5543..... OBGYN-8	24-0306..... GEN-249, O/A-92, RET-65	24-2020A..... GEN-242, RET-93
23-5544..... OBGYN-8	24-0307..... GEN-249, O/A-92, RET-65	24-2210..... ENT-114, GEN-247, O/A-93, RET-69, SPN-134
23-5545..... OBGYN-8	24-0327..... GEN-249, RET-67	24-2211..... ENT-114, GEN-247, O/A-93, RET-69, SPN-134
23-5546..... OBGYN-8	24-0352..... ENT-113, GEN-249, O/A-92, RET-67	24-2213..... ENT-114, GEN-247, O/A-93, RET-69, SPN-134
23-5599..... OBGYN-5	24-0888..... ENT-116, GEN-250, RET-148	24-2214..... ENT-114, GEN-247, O/A-93, RET-69, SPN-134
23-5670..... OBGYN-7	24-0909..... ENT-107, GEN-224, RET-65	24-2216..... ENT-114, GEN-247, O/A-93, RET-69, SPN-134
23-5680..... OBGYN-7	24-0910..... ENT-107, GEN-224, RET-65	24-2217..... ENT-114, GEN-247, O/A-93, RET-69, SPN-134
23-5917..... GEN-250, RET-156	24-0911..... GEN-224, O/A-80, RET-65	24-2220..... ENT-114, GEN-247, O/A-93, RET-69, SPN-134
23-6290..... RET-41	24-0912..... GEN-224, O/A-80, RET-65	24-2221..... ENT-114, GEN-247, O/A-93, RET-69, SPN-134
23-6292..... GEN-214, RET-41	24-1007..... ENT-113, GEN-240, NEU-83, PED-28, RET-63	24-2224..... ENT-114, GEN-247, O/A-93, RET-69, SPN-134
23-6300..... GEN-214, RET-41	24-1008..... ENT-113, GEN-240, NEU-83, PED-28, RET-63	24-2225..... ENT-114, GEN-247, O/A-93, RET-69
23-6301..... GEN-229, SPN-121	24-1010..... ENT-113, GEN-240, NEU-134, PED-28, RET-63	24-2500..... SPN-80
23-6302..... GEN-229, SPN-121	24-1011..... ENT-113, GEN-240, NEU-83, PED-28, RET-63	24-2505..... SPN-2
23-6303..... GEN-229	24-1310..... ENT-112, GEN-239, NEU-82, RET-107	24-2506..... SPN-2
23-6346..... GEN-228, RET-53		24-2510..... SPN-9, SS-47
23-6381..... GEN-224, RET-50, SPN-98		24-2613..... ENT-114, RET-70
23-6382..... GEN-224, RET-50		24-2614..... ENT-114, RET-70
23-7040..... GEN-223, RET-143		24-2620..... ENT-111, RET-67
23-7062..... RET-143		
23-7106..... GEN-223, RET-143		
23-7211..... GEN-220, RET-47		
23-7212..... GEN-220, RET-47		

- 24-2625 ENT-111, RET-67
 24-2670 GEN-238, NEU-82,
 RET-106
 24-2671 GEN-238, NEU-82,
 RET-106
 24-2801 GEN-213, RET-37
 24-2802 GEN-213, RET-37
 24-2803 RET-37
 24-2810 GEN-213, NEU-64,
 RET-37, RET-39
 24-3013 RET-69
 24-3014 GEN-248, O/A-93,
 RET-69
 24-3016 RET-69
 24-3017 GEN-248, O/A-93,
 RET-69
 24-3020 RET-69
 24-3021 GEN-248, O/A-93,
 RET-69
 24-3023 GEN-248, O/A-93,
 RET-69
 24-3024 GEN-248, O/A-93,
 RET-69
 24-3380 GEN-183, RET-43
 24-3425 GEN-241
 24-3426 GEN-241
 24-3446 GEN-241
 24-3449 O/A-84, RET-66,
 SPN-98
 24-3500 O/A-81, RET-65,
 SPN-98
 24-4013 GEN-244, RET-63
 24-4015 GEN-244, RET-63
 24-4017 GEN-244, RET-63
 24-4018 GEN-244, RET-63
 24-4057 GEN-244, RET-63
 24-4166 RET-66
 24-4167 RET-66
 24-4168 RET-66
 24-4169 RET-66
 24-4170 RET-66
 24-4172 RET-66
 24-4173 RET-66
 24-4174 O/A-94
 24-4175 O/A-82, RET-66
 24-4176 RET-66
 24-4178 RET-66
 24-4218 RET-32
 24-4530 SPN-121
 24-4590 O/A-83, RET-121
 24-4591 O/A-83, RET-121
 24-4617 O/A-94
 24-4618 O/A-94
 24-4760 GEN-248, O/A-93,
 RET-71
 24-4760-L O/A-93
 24-5012 RET-3
 24-5012B GEN-179
 24-5014 RET-3
 24-5014B GEN-179
 24-5022 RET-3
 24-5022B GEN-179
 24-5024 RET-3
 24-5024B GEN-179, OBE-45
 24-5026 RET-3
 24-5028B GEN-180
 24-5030 RET-3
 24-5032 RET-3
 24-5032B GEN-179, OBE-52
 24-5034 RET-3
 24-5036 RET-3
 24-5036B GEN-180
 24-5060C GEN-179
 24-5062C GEN-181, OBE-44
 24-5062L GEN-181
 24-5100 LAP-42
 24-5104 LAP-36
 24-5110 LAP-34
 24-5127 LAP-44
 24-5157 LAP-35
 24-5157R LAP-35
 24-5158 LAP-35
 24-5158R LAP-35
 24-5200 LAP-38
 24-5200-1 RET-3
 24-5200A GEN-177, OBE-51,
 RET-2
 24-5200AA GEN-177, OBE-43,
 RET-2
 24-5200AAA GEN-177, OBE-43,
 RET-2
 24-5201 GEN-177, RET-5
 24-5202 RET-5
 24-5202A LAP-37
 24-5203 RET-5
 24-5203A LAP-38
 24-5204 GEN-177, RET-5
 24-5205 LAP-38
 24-5301 LAP-43
 24-5302 LAP-42
 24-5507 LAP-28
 24-5620 LAP-37
 24-5640 LAP-37
 24-7002 RET-6
 24-7010 RET-3
 24-7015 GEN-177, RET-4
 24-7017 GEN-177, OBE-43,
 RET-4
 24-7020 RET-3
 24-7071 GEN-179, OBE-52
 24-7072 GEN-179, OBE-52
 24-7073 GEN-179, OBE-52,
 RET-4
 24-7074 GEN-179, OBE-52
 24-7075 GEN-179, OBE-52
 24-7085 GEN-180
 24-8500 GEN-184, OBGYN-33,
 RET-7
 24-8509 GEN-184, OBGYN-33,
 OBGYB-34, RET-7
 24-8511 GEN-184, OBGYN-33,
 OBGYB-34, RET-7
 24-8512 GEN-184, OBGYN-33,
 OBGYB-34, RET-7
 24-8599 GEN-184, OBGYN-33,
 OBGYB-34, RET-7
 25-005-000 O/A-51
 25-006-000 O/A-10
 25-015-000 O/A-12
 25-019-000 O/A-56
 25-022-000 O/A-12, O/A-51
 25-023-000 O/A-56
 25-024-000 O/A-12
 25-028-000 O/A-12, O/A-52
 25-034-000 O/A-12
 25-035-000 O/A-12
 25-2504 SPN-2
 25-2526 GEN-140
 25-2905-11 SPN-143
 25-4000 ENT-19, GEN-20
 25-4002 ENT-18, GEN-20,
 PED-6
 25-4005 GEN-19
 25-5106 SPN-87
 25-5525 OBGYN-10
 25-5526 OBGYN-10
 25-5527 OBGYN-10
 25-5528 OBGYN-10
 25-5529 OBGYN-10
 25-5530 OBGYN-10
 25-5531 OBGYN-10
 25-5532 OBGYN-10
 25-5533 OBGYN-10
 25-5551 OBGYN-12
 25-5552 OBGYN-12
 25-5553 OBGYN-12
 25-5554 OBGYN-12
 25-5555 OBGYN-12
 25-5556 OBGYN-12
 25-5557 OBGYN-12
 25-5558 OBGYN-12
 25-5569 GEN-20
 25-5569 ENT-19, PED-7
 25-8009 CVT-64
 25-8015 CVT-64
 25-8016 CVT-64
 25-8017 CVT-64
 25-8018 CVT-64

25-8019.....CVT-64	26-4225 ENT-25, O/A-26, SPN-55	26-6416..... O/A-27
25-8020.....CVT-64	26-4226 O/A-22, SPN-50	26-7003 CVT-188
25-8021.....CVT-64	26-4404..... O/A-24, SPN-52	26-7004 CVT-188
25-8022 CVT-64, PED-7	26-4450..... SPN-56	26-7005 CVT-188
25-8023 CVT-64, PED-7	26-4452 O/A-27, SPN-56	26-7006 CVT-188
25-8024 CVT-64	26-4453 O/A-27, SPN-56	26-7010..... CVT-188
25-8035 CVT-66, GEN-20	26-4454 O/A-27, SPN-56	27-0213..... O/A-60
25-8036 CVT-66, GEN-20, PED-7	26-4455 O/A-27, SPN-56	27-0400..... O/A-60
25-8037 CVT-66, GEN-20, PED-7	26-4457 O/A-28, SPN-56	27-0401..... O/A-60
25-8038 CVT-66, GEN-20, PED-7	26-4458 O/A-28, SPN-56	27-0420 O/A-57
25-8039 CVT-66, GEN-20, PED-7	26-4550 O/A-27	27-0422 O/A-57
25-8040 CVT-66, GEN-20	26-4551..... O/A-27	27-0630 O/A-60
25-8041..... CVT-66, GEN-20	26-4738 O/A-28, SPN-56	27-0840 O/A-57
25-8042 CVT-66, GEN-20	26-4801 O/A-21	27-0866 O/A-61
25-8043 CVT-66, GEN-20	26-4802..... O/A-21	27-0870 O/A-59
25-8044 CVT-66, GEN-20	26-4803..... O/A-21	27-0880 O/A-58
26-0513..... ENT-100	26-4804..... O/A-21	27-0899 O/A-61
26-1000 NEU-20	26-4809..... O/A-19, SPN-40	27-2702..... GEN-215
26-1001..... NEU-20	26-4910 SPN-49	27-2703..... GEN-215
26-1002..... NEU-20	26-4913..... SPN-49	27-2704 GEN-215
26-1004 NEU-20	26-4919..... SPN-49	27-2706 GEN-215
26-1006 NEU-20	26-4925 SPN-49	27-5008 SPN-89
26-1008 NEU-21	26-4930 SPN-49	27-5010..... SPN-89
26-1012 NEU-64, SPN-96	26-4949..... SPN-49	27-5100..... LAP-42
26-1041 NEU-17	26-5001 SPN-49	27-5502..... O/A-65, SPN-89
26-1075..... NEU-17	26-5002..... SPN-49	27-5504 O/A-65, SPN-89
26-1080 NEU-20	26-5003..... SPN-49	27-5505 O/A-65, SPN-89
26-1181..... NEU-19	26-5004..... SPN-49	27-5506 O/A-65, SPN-89
26-1265..... NEU-18, SPN-45, SPN-72, SPN-107	26-5005..... SPN-49	27-5508 O/A-65
26-1266..... NEU-18, SPN-72, SPN-107	26-5007..... CVT-63, NEU-6	27-5510 O/A-65
26-1267..... NEU-18, SPN-72, SPN-107	26-5020 O/A-22, OBE-20, SPN-49	27-5512 O/A-65, SPN-89
26-1268..... NEU-18, SPN-72, SPN-107	26-5021..... O/A-22, OBE-20, SPN-49	27-5516 O/A-65, SPN-89
26-1350..... O/A-31, SPN-58	26-5022 O/A-22, OBE-20, SPN-49	27-5519 O/A-65, SPN-89
26-1411..... O/A-25, SPN-53	26-5023 O/A-22, OBE-20, SPN-49	27-5522..... O/A-65, SPN-89
26-1412 O/A-25, SPN-53	26-5026 SS-47	27-5524..... O/A-65, SPN-89
26-1428..... O/A-31, SPN-58	26-5500..... O/A-20, SPN-50	27-5526..... O/A-65, SPN-89
26-1450..... O/A-32, SPN-58	26-5503 O/A-20, SPN-50	27-5702..... O/A-66, SPN-91
26-1501 O/A-76, SPN-96	26-5604..... O/A-25, SPN-52	27-5704 O/A-66, SPN-91
26-1502..... O/A-76, SPN-96	26-5606..... O/A-25, SPN-52	27-5706 O/A-66, SPN-91
26-2766 O/A-22, SPN-50	26-5612..... O/A-25, SPN-52	27-5708 O/A-66, SPN-91
26-2777 O/A-20, SPN-48	26-5620 O/A-25, SPN-52	27-5710 O/A-66, SPN-91
26-3700 O/A-19, SPN-55	26-5621..... O/A-19, SPN-48	27-5712 O/A-66, SPN-91
26-3703 ENT-25	26-5622 O/A-19, SPN-48	27-5714 O/A-66, SPN-91
26-3707 ENT-25	26-5623 O/A-19, SPN-48	27-5715 O/A-66, SPN-91
26-3750 O/A-28, SPN-57	26-5624 O/A-19, SPN-48	27-5718 O/A-66, SPN-91
26-3751..... O/A-28, SPN-57	26-5625 O/A-19, O/A-25, SPN-52	27-5719 O/A-66, SPN-91
26-4224 ENT-25, O/A-26, SPN-55	26-6201..... CVT-70, O/A-23, SPN-51	27-5720..... O/A-66, SPN-91
	26-6202 O/A-23	27-5812 SPN-90
	26-6203 O/A-23, SPN-51	27-6004..... O/A-4, SPN-4
		27-6063 O/A-43, SPN-64
		27-6202 O/A-68, SPN-92
		27-6204 O/A-68, SPN-92
		27-6206 O/A-68, SPN-92
		27-6208 O/A-68, SPN-92
		27-6210 O/A-68, SPN-92
		27-6215 O/A-68, SPN-92

27-6218.....	O/A-68	28-4465.....	SPN-94	28-5260.....	O/A-44, SPN-65
27-6413.....	SPN-95	28-4470.....	SPN-94	28-5262.....	O/A-44, SPN-65
27-9411.....	O/A-109, SPN-95	28-4512.....	O/A-45, SPN-66	28-5266.....	O/A-44, SPN-65
27-9412.....	O/A-109, SPN-95	28-4515.....	O/A-45, SPN-66	28-5270.....	O/A-44, SPN-65
27-9413.....	O/A-109	28-4525.....	O/A-45, SPN-66	28-5275.....	O/A-44, SPN-65
27-9415.....	O/A-109, SPN-95	28-4903.....	O/A-65, SPN-88	28-5280.....	O/A-44, SPN-65
27-9502.....	O/A-109, SPN-191	28-4904.....	O/A-65, SPN-88	28-5290.....	O/A-44, SPN-65
27-9503.....	O/A-109, SPN-191	28-4906.....	O/A-65, SPN-88	28-5301.....	O/A-44
27-9504.....	O/A-109, SPN-191	28-4908.....	O/A-65, SPN-88	28-5407.....	O/A-5, SPN-5
27-9505.....	O/A-109, SPN-191	28-4910.....	O/A-65, SPN-88	28-5410.....	O/A-5, SPN-5
27-9506.....	O/A-109, SPN-191	28-4912.....	O/A-65, SPN-88	28-5412.....	O/A-5, SPN-5
27-9507.....	O/A-109, SPN-191	28-4953.....	O/A-65, SPN-88	28-5435.....	O/A-5, SPN-5
27-9508.....	O/A-109	28-4954.....	O/A-65, SPN-88	28-5439.....	O/A-5, SPN-5
27-9510.....	SPN-191	28-4956.....	O/A-65, SPN-88	28-6255.....	O/A-45, SPN-66
27-9516.....	O/A-109, SPN-191	28-4958.....	O/A-65, SPN-88	28-7020.....	O/A-62, SPN-86
27-9520.....	O/A-109, SPN-191	28-4960.....	O/A-65, SPN-88	28-7021.....	O/A-62, SPN-86
27-9534.....	O/A-109, SPN-190	28-4962.....	O/A-65, SPN-88	28-7022.....	O/A-62, SPN-86
27-9535.....	O/A-109, SPN-190	28-5006.....	O/A-5, SPN-4	28-7023.....	O/A-62, SPN-86
27-9536.....	O/A-109, SPN-190	28-5010.....	O/A-5, SPN-4	28-7024.....	O/A-62, SPN-86
27-9601.....	SPN-191	28-5012.....	O/A-5, SPN-4	28-7025.....	O/A-62, SPN-86
27-9602.....	SPN-191	28-5016.....	O/A-5, SPN-4	28-7027.....	SPN-86
27-9603.....	SPN-191	28-5020.....	O/A-5, SPN-4	28-7028.....	O/A-62, SPN-86
28-1000.....	O/A-49, SPN-69	28-5025.....	O/A-5, SPN-4	28-7029.....	O/A-62, SPN-86
28-1001.....	NEU-21, SPN-46, SPN-72, SPN-107	28-5032.....	O/A-5, SPN-4	28-7030.....	O/A-62, SPN-86
28-1002.....	NEU-21, SPN-46, SPN-72, SPN-107	28-5056.....	O/A-5, SPN-4	28-7031.....	O/A-62, SPN-86
28-1003.....	O/A-49, SPN-70	28-5062.....	O/A-5, SPN-4	28-7032.....	O/A-62, SPN-86
28-1022.....	SPN-86	28-5070.....	O/A-5, SPN-4	28-7033.....	O/A-62, SPN-86
28-1023.....	SPN-86	28-5075.....	O/A-5, SPN-4	28-7106.....	O/A-69, SPN-93
28-1026.....	O/A-7, SPN-7, SPN-86	28-5106.....	O/A-64	28-7112.....	O/A-69, SPN-93
28-2012.....	O/A-7, SPN-7	28-5110.....	O/A-64, SPN-87	28-7115.....	O/A-69, SPN-93
28-2018.....	O/A-7, SPN-7	28-5112.....	O/A-64, SPN-87	28-7120.....	O/A-69, SPN-93
28-2106.....	O/A-70, SPN-94	28-5116.....	O/A-64, SPN-87	28-7125.....	O/A-69, SPN-93
28-2112.....	O/A-70, SPN-94	28-5120.....	O/A-64, SPN-87	28-7130.....	O/A-69, SPN-93
28-2118.....	O/A-70	28-5122.....	O/A-64, SPN-87	28-7156.....	O/A-69, SPN-93
28-2606.....	O/A-3, SPN-4	28-5125.....	O/A-64, SPN-87	28-7159.....	O/A-69, SPN-93
28-2804.....	O/A-43, SPN-63	28-5130.....	O/A-64, SPN-87	28-7162.....	O/A-69, SPN-93
28-2806.....	O/A-43, SPN-63	28-5132.....	O/A-64, SPN-87	28-7165.....	O/A-69, SPN-93
28-2808.....	O/A-43, SPN-63	28-5140.....	O/A-64, SPN-87	28-7175.....	O/A-69, SPN-93
28-2814.....	O/A-43, SPN-63	28-5156.....	O/A-64, SPN-87	28-7180.....	O/A-69, SPN-93
28-4008.....	CVT-220, GEN-310, SS-45	28-5160.....	O/A-64, SPN-87	28-7230.....	O/A-45, SPN-93
28-4010.....	CVT-220, GEN-313, SS-47	28-5162.....	O/A-64, SPN-87	28-7280.....	O/A-45, SPN-93
28-4011.....	CVT-221, GEN-313, SS-47	28-5166.....	O/A-64	28-8011.....	SPN-65
28-4320.....	O/A-6, SPN-7	28-5170.....	O/A-64	28-8012.....	SPN-65
28-4325.....	O/A-6, SPN-7	28-5172.....	O/A-64, SPN-87	28-8013.....	SPN-65
28-4404.....	SPN-94	28-5175.....	O/A-64, SPN-87	28-8014.....	SPN-65
28-4408.....	SPN-94	28-5180.....	O/A-64, SPN-87	28-9406.....	O/A-66, SPN-90
28-4410.....	O/A-67, SPN-94	28-5182.....	O/A-64, SPN-87	28-9412.....	O/A-66, SPN-90
28-4412.....	SPN-94	28-5190.....	O/A-64, SPN-87	28-9420.....	O/A-66, SPN-90
28-4414.....	O/A-67, SPN-94	28-5206.....	O/A-44, SPN-65	28-9430.....	O/A-66, SPN-90
28-4418.....	O/A-67, SPN-94	28-5210.....	O/A-44, SPN-65	28-9440.....	O/A-66, SPN-90
28-4422.....	O/A-67, SPN-94	28-5212.....	O/A-44, SPN-65	29-0401.....	O/A-4, SPN-3
		28-5216.....	O/A-44, SPN-65	29-1816.....	URO-7
		28-5220.....	O/A-44, SPN-65	29-1818.....	URO-7
		28-5225.....	O/A-44, SPN-65	29-1820.....	URO-7
		28-5240.....	O/A-44, SPN-65	29-1822.....	URO-7
		28-5256.....	O/A-44, SPN-65	29-1824.....	URO-7

29-1826.....	URO-7	29-5156.....	SPN-32	29-6013.....	SPN-26
29-1828.....	URO-7	29-5156A.....	SPN-31	29-6013A.....	SPN-26
29-1830.....	URO-7	29-5320.....	SPN-33	29-6014.....	SPN-26
29-1832.....	URO-7	29-5324.....	SPN-33	29-6014A.....	SPN-26
29-1834.....	URO-7	29-5333.....	SPN-33	29-6015.....	SPN-26
29-3312.....	URO-3	29-5342.....	SPN-33	29-6015A.....	SPN-26
29-3314.....	URO-3	29-5350.....	SPN-33	29-6016.....	SPN-26
29-3316.....	URO-3	29-5351.....	SPN-33	29-6016A.....	SPN-26
29-3318.....	URO-3	29-5352.....	SPN-33	29-6017.....	SPN-26
29-3320.....	URO-3	29-5353.....	SPN-33	29-6017A.....	SPN-26
29-3322.....	URO-3	29-5354.....	SPN-33	29-6018A.....	SPN-26
29-3324.....	URO-3	29-5355.....	SPN-33	29-6019.....	SPN-26
29-4096.....	SPN-13	29-5356.....	SPN-33	29-6020.....	SPN-26
29-4860.....	SPN-25	29-5359.....	SPN-32	29-6020A.....	SPN-26
29-4861.....	SPN-25	29-5360.....	SPN-32	29-6333.....	SPN-14
29-4862.....	SPN-25	29-5364.....	SPN-32	29-6342.....	SPN-14
29-4863.....	SPN-25	29-5373.....	SPN-32	29-6350.....	SPN-14
29-4865.....	SPN-25	29-5382.....	SPN-32	29-6351.....	SPN-14
29-4866.....	SPN-25	29-5390.....	SPN-32	29-6352.....	SPN-14
29-4867.....	SPN-25	29-5391.....	SPN-32	29-6353.....	SPN-14
29-4868.....	SPN-25	29-5392.....	SPN-32	29-6354.....	SPN-14
29-4902.....	SPN-13	29-5393.....	SPN-32	29-6706.....	ENT-10
29-4906.....	O/A-14	29-5396.....	SPN-32	29-6715.....	ENT-10
29-4936.....	SPN-26	29-5399.....	SPN-28	29-6724.....	ENT-10
29-4937.....	SPN-26	29-5400.....	SPN-28	29-6733.....	ENT-10
29-4938.....	SPN-26	29-5401.....	SPN-28	29-6742.....	ENT-10
29-4939.....	SPN-26	29-5402.....	SPN-28	29-6750.....	ENT-10
29-4940.....	SPN-26	29-5403.....	LAP-28	29-6751.....	ENT-10
29-4941.....	SPN-26	29-5407.....	SPN-28	29-6752.....	ENT-10
29-4950.....	SPN-25	29-5524.....	SPN-30	29-7070.....	SPN-13
29-4952.....	SPN-25	29-5533.....	SPN-30	29-7071.....	O/A-14, SPN-13
29-5026.....	SPN-27	29-5533A.....	SPN-30	29-7072.....	O/A-14, SPN-13
29-5028.....	SPN-27	29-5542.....	SPN-30	29-7073.....	O/A-14, SPN-13
29-5029.....	SPN-27	29-5542A.....	SPN-30	29-7076.....	O/A-14, SPN-13
29-5030.....	SPN-27	29-5550.....	SPN-30	29-7077.....	O/A-14, SPN-13
29-5032.....	SPN-27	29-5550A.....	SPN-30	29-7078.....	O/A-14, SPN-13
29-5123.....	SPN-32	29-5551.....	SPN-30	29-7079.....	O/A-14, SPN-13
29-5123A.....	SPN-31	29-5551A.....	SPN-30	29-8010.....	SPN-13
29-5124.....	SPN-32	29-5552.....	SPN-30	29-8011.....	SPN-13
29-5124A.....	SPN-31	29-5552A.....	SPN-30	29-8012.....	SPN-13, SPN-14
29-5133.....	SPN-32	29-5553.....	SPN-30	29-8372.....	SPN-13
29-5133A.....	SPN-31	29-5553A.....	SPN-30	29-8501.....	SPN-38
29-5142.....	SPN-32	29-5554.....	SPN-30	29-8502.....	SPN-38
29-5142A.....	SPN-31	29-5554A.....	SPN-30	29-8503.....	SPN-38
29-5150.....	SPN-32	29-5555.....	SPN-30	29-8513.....	SPN-38
29-5150A.....	SPN-31	29-5555A.....	SPN-30	29-8514.....	SPN-38
29-5151.....	SPN-32	29-5556.....	SPN-30	29-8517.....	SPN-38
29-5151A.....	SPN-31	29-5556A.....	SPN-30	29-8818A.....	SPN-33
29-5152.....	SPN-32	29-5934.....	SPN-32	29-8819A.....	SPN-33
29-5152A.....	SPN-31	29-5935.....	SPN-32	29-8820A.....	SPN-33
29-5153.....	SPN-32	29-6010.....	SPN-26	29-8821A.....	SPN-33
29-5153A.....	SPN-31	29-6010A.....	SPN-26	29-8822A.....	SPN-33
29-5154.....	SPN-32	29-6011.....	SPN-26	29-8823.....	SPN-35
29-5154A.....	SPN-31	29-6011A.....	SPN-26	29-8823A.....	SPN-33
29-5155.....	SPN-32	29-6012.....	SPN-26	29-8824A.....	SPN-33
29-5155A.....	SPN-31	29-6012A.....	SPN-26	29-8825A.....	SPN-33

29-8826A	SPN-33	30-1147	CVT-101	30-1290	NEU-30, O/A-35, SPN-59
30-005-000.....	O/A-51	30-1150	CVT-80, GEN-45, NEU-31	30-1295.....	NEU-30, O/A-35, OBE-24, SPN-60
30-009-000.....	O/A-54	30-1151.....	CVT-80	30-1296.....	NEU-30, O/A-35, OBE-24, SPN-60
30-014-000	O/A-56	30-1152	CVT-80, GEN-45, NEU-31	30-1298.....	NEU-29, O/A-33, OBE-23, SPN-59
30-024-000	O/A-56	30-1154	CVT-80, GEN-45, NEU-31	30-1310	CVT-187, NEU-30, O/A-34, PED-32, SPN-59
30-026-000.....	O/A-55	30-1155	CVT-80, GEN-44, NEU-31	30-1360	GEN-105, NEU-37, PED-15
30-032-000 ...	O/A-53, RET-95	30-1156	CVT-80, GEN-44	30-2001	ENG-31
30-034-000... ..	O/A-52, RET-92	30-1160	CVT-82, GEN-48, NEU-32	30-2003.....	ENG-31
30-035-000.....	O/A-51	30-1165	CVT-81, GEN-48, NEU-32	30-2540.....	GEN-75, NEU-38
30-038-000.....	RET-92	30-1166	CVT-108, GEN-96, NEU-39	30-2545	ENT-120, O/A-95
30-041-000	O/A-50	30-1170	GEN-107, NEU-40, PED-48	30-2546	ENT-120, O/A-95
30-0001.....	ENG-50	30-1172	NEU-38	30-2547	ENT-120, O/A-95
30-0002.....	ENG-50	30-1180	CVT-82, GEN-49, NEU-32	30-3018	GEN-7
30-0003	ENG-50	30-1185	CVT-79, GEN-43, NEU-31, PED-9	30-3184	O/A-96
30-0004	ENG-50	30-1186	CVT-99, GEN-78, PED-46	30-3185.....	NEU-109, O/A-96
30-0201	ENT-118, NEU-108, O/A-97, SPN-137	30-1187	CVT-99, GEN-78, PED-46	30-3818	O/A-94
30-0202.....	ENT-118, NEU-108, O/A-97, SPN-137	30-1188	CVT-99, GEN-78, PED-46	30-4009	GEN-52, PED-13
30-0203.....	ENT-118, NEU-108, O/A-97, SPN-137	30-1189	CVT-100, GEN-79, PED-46	30-4020.....	CVT-117, GEN-98, PED-12
30-0204.....	ENT-118, NEU-108, O/A-97, SPN-137	30-1190	CVT-79, GEN-43, NEU-31, PED-9	30-4021	CVT-117, GEN-98, PED-12
30-0514	ENT-118, NEU-85, O/A-97, SPN-137	30-1191.....	CVT-78, GEN-43, NEU-31	30-4035.....	CVT-115, GEN-87
30-0516	ENT-118, NEU-85, O/A-97, SPN-137	30-1194	GEN-103, NEU-41	30-4038.....	GEN-54
30-1000	GEN-31, NEU-33	30-1201.....	CVT-104, GEN-90, NEU-38	30-4039.....	CVT-87, GEN-54
30-1001.....	ENG-57	30-1203.....	CVT-104, GEN-45, NEU-31, SPN-60	30-4066	CVT-89, GEN-60
30-1002	ENG-57	30-1204	GEN-90, NEU-36	30-4080	CVT-83, GEN-102
30-1003	ENG-57	30-1205.....	CVT-81, GEN-47, NEU-40, NEU-135	30-4081	CVT-83, GEN-102
30-1004	ENG-57	30-1210	CVT-105, GEN-95, NEU-39	30-4088.....	GEN-51
30-1010.....	CVT-99, GEN-52	30-1213	CVT-105, GEN-94, NEU-39	30-4095.....	GEN-104
30-1011.....	CVT-99, ENG-50, GEN-52	30-1214	CVT-81, GEN-47, NEU-32	30-4105	GEN-54, PED-11
30-1012.....	ENG-50	30-1216	CVT-81, GEN-46, NEU-32	30-4106	GEN-54, PED-11
30-1013.....	ENG-50	30-1228.....	SPN-61	30-4133.....	CVT-80
30-1014.....	ENG-50	30-1230.....	CVT-71, GEN-34, NEU-28, PED-8	30-4134	CVT-80, PED-10
30-1015.....	ENG-57	30-1280.....	CVT-112, GEN-4	30-4135.....	CVT-80
30-1030	SPN-68			30-4137.....	CVT-80
30-1035L.....	LAP-47			30-4138	CVT-80, GEN-46, OBE-24
30-1115.....	CVT-87, GEN-96, NEU-37			30-4139.....	CVT-80, GEN-46, OBE-24
30-1117.....	GEN-86, NEU-30			30-4151.....	CVT-111, GEN-111, PED-48
30-1129	CVT-101, GEN-84			30-4152.....	CVT-111, GEN-111, PED-48
30-1132	CVT-104, GEN-92, NEU-39			30-4153.....	CVT-111, GEN-111, PED-48
30-1140.....	CVT-102, GEN-88, NEU-38			30-4155.....	CVT-111, GEN-111
30-1142	CVT-102, GEN-88, NEU-38			30-4156.....	CVT-111, GEN-111, OBE-33
30-1143	CVT-102, GEN-88, NEU-38			30-4157.....	CVT-111, GEN-111, OBE-33
30-1145	CVT-102, GEN-88, NEU-38				
30-1146.....	CVT-101				

- 30-4161.....CVT-111, GEN-111,
PED-48
- 30-4200..... CVT-101, GEN-86
- 30-4201..... CVT-101, GEN-86
- 30-4202..... CVT-101
- 30-4208..... CVT-79, GEN-44,
PED-9
- 30-4214..... CVT-79, GEN-43,
NEU-31, PED-9
- 30-4215.....CVT-80, GEN-46,
PED-10
- 30-4216..... CVT-104, GEN-92,
PED-47
- 30-4218..... CVT-104, GEN-78,
PED-46
- 30-4220.....CVT-110, GEN-106,
PED-48
- 30-4221..... CVT-110, GEN-106
- 30-4222..... CVT-110, GEN-106
- 30-4230..... CVT-108, GEN-99
- 30-4231..... CVT-108, GEN-99
- 30-4239..... CVT-101, GEN-86
- 30-4255..... GEN-69
- 30-4258..... GEN-69
- 30-4291..... GEN-60
- 30-4295..... GEN-50
- 30-4297..... GEN-97
- 30-4300..... GEN-56, OBE-28
- 30-4305..... GEN-62
- 30-4306..... GEN-62
- 30-4330.....GEN-116
- 30-4340.....GEN-41
- 30-4462..... CVT-119, GEN-56,
PED-13
- 30-4464..... CVT-115, GEN-53
- 30-4465.....GEN-81
- 30-4466.....CVT-100, GEN-80,
PED-16
- 30-4467..... CVT-85, GEN-53,
PED-11
- 30-4468..... CVT-85, GEN-53,
PED-11
- 30-4470..... CVT-93, GEN-56,
PED-12
- 30-4471..... CVT-93, GEN-56,
PED-12
- 30-4472..... CVT-93, GEN-56,
PED-12
- 30-4473..... CVT-93, GEN-56
- 30-4474..... CVT-93, GEN-56,
PED-12
- 30-4485..... GEN-102, PED-12
- 30-4490.....CVT-116, GEN-54,
PED-9
- 30-4491.....CVT-116, GEN-54,
PED-9
- 30-4492.....CVT-30, GEN-92
- 30-4493 CVT-28, GEN-6, PED-5
- 30-4494..... CVT-28, GEN-6
- 30-4500..... GEN-98
- 30-4501..... GEN-98
- 30-4502..... GEN-98
- 30-4517..... CVT-90, GEN-108
- 30-4535..... CVT-108, GEN-99
- 30-4542..... CVT-100, GEN-80
- 30-4554..... CVT-110, GEN-109
- 30-4563.....CVT-120, GEN-59
- 30-4565.....CVT-120, GEN-58
- 30-4573..... CVT-120, GEN-58,
OBE-29
- 30-4652..... GEN-112
- 30-4700.....CVT-77, GEN-85,
OBE-24
- 30-4701..... CVT-78, GEN-100,
OBE-25, OBGYN-15
- 30-4856..... NEU-36
- 30-5018..... ENT-119
- 30-5118..... ENT-119
- 30-5217..... NEU-86, O/A-99,
SPN-139
- 30-5312..... NEU-109, O/A-96,
SPN-136
- 30-5421..... NEU-105
- 30-5423..... NEU-105
- 30-5525..... GEN-61, OBGYN-16
- 30-5526..... GEN-61
- 30-5527..... GEN-61
- 30-5529..... GEN-61
- 30-5536... GEN-118, OBGYN-24
- 30-5561... GEN-117, OBGYN-23
- 30-5570... GEN-84, OBGYN-14
- 30-5580... GEN-118, OBGYN-24
- 30-5595... GEN-118, OBGYN-24
- 30-5604..... OBGYN-26
- 30-5605... GEN-117, OBGYN-26
- 30-5615... GEN-118, OBGYN-25
- 30-5640..... OBGYN-24
- 30-5655..... OBGYN-22
- 30-5656..... OBGYN-22
- 30-5668..... OBGYN-22
- 30-5671..... OBGYN-21
- 30-5695..... GEN-55
- 30-5800... GEN-61, OBGYN-17
- 30-5801... GEN-82, OBGYN-15
- 30-6173..... GEN-97
- 30-6520..... GEN-46, PED-11
- 30-6524..... GEN-46, PED-11
- 30-6530..... GEN-97, PED-16
- 30-6532..... GEN-97, PED-47
- 30-6555..... GEN-84, PED-45
- 30-6556..... GEN-84, PED-45
- 30-6557..... PED-45
- 30-6585..... GEN-112, PED-45
- 30-6695..... GEN-103, PED-49
- 30-6712..... GEN-97, NEU-42,
PED-47
- 30-6713..... NEU-42, PED-47
- 30-6714..... GEN-97, NEU-42,
PED-47
- 30-6715..... GEN-97, PED-47
- 30-6898..... ENT-48, GEN-32,
PED-10
- 30-6951..... ENT-48, PED-10
- 30-6995..... CVT-82, GEN-48,
NEU-32, PED-10
- 30-7102..... ENT-118
- 30-7103..... ENT-118
- 30-7315..... GEN-116
- 30-7613..... ENT-120, O/A-105,
SPN-142
- 30-7614..... ENT-120, O/A-105,
SPN-142
- 30-7617..... O/A-41, SPN-142
- 30-7619..... ENT-122, NEU-85,
SPN-138
- 30-7620..... ENT-122, NEU-85,
O/A-99, SPN-139
- 30-7621..... ENT-121
- 30-7622..... ENT-122, NEU-107,
O/A-99, SPN-139
- 30-7623..... ENT-122, NEU-85,
O/A-99, SPN-139
- 30-7624..... ENT-122, NEU-85,
O/A-99, SPN-139
- 30-7625..... ENT-122, NEU-85,
O/A-99, SPN-139
- 30-7627..... NEU-86, O/A-101
- 30-7959..... ENT-121
- 30-8000..... ENT-121
- 30-8002..... CVT-127, GEN-42,
PED-8
- 30-8014..... CVT-77
- 30-8015..... GEN-120
- 30-8016..... CVT-71
- 30-8018..... CVT-114
- 30-8020..... CVT-82, GEN-49
- 30-8022..... CVT-82, GEN-49,
OBE-25
- 30-8023..... CVT-110, GEN-104
- 30-8024..... CVT-110, GEN-104
- 30-8042..... GEN-122
- 30-8043..... GEN-122
- 30-8049..... CVT-99, GEN-76,
OBE-7
- 30-8051..... CVT-45, GEN-95,
OBE-6
- 30-8056..... CVT-90, GEN-64,
OBE-28

- 30-8059..... CVT-72, GEN-26
 30-8065 CVT-35, GEN-11, OBE-7
 30-8070..... CVT-98, GEN-76
 30-8072..... CVT-98, GEN-76
 30-8073..... CVT-98, GEN-76
 30-8082..... CVT-98, GEN-109,
 OBE-29
 30-8085..... CVT-111, GEN-113,
 OBE-33
 30-8090..... CVT-120, GEN-60,
 OBE-27
 30-8091..... CVT-120, OBE-27
 30-8092..... GEN-58, OBE-27
 30-8093..... CVT-98, GEN-59,
 OBE-27
 30-8095..... CVT-91, GEN-90
 30-8112..... CVT-109, GEN-99
 30-8122..... CVT-82, GEN-49,
 OBE-25
 30-8123..... CVT-110, GEN-104,
 OBE-32
 30-8131..... CVT-112, GEN-121,
 PED-16
 30-8132..... CVT-112, GEN-121
 30-8133..... CVT-112, GEN-121,
 OBE-34
 30-8400..... CVT-113, GEN-122,
 PED-16
 30-8401..... CVT-113, GEN-122
 30-8402..... CVT-113
 30-8403..... CVT-113
 30-8404..... CVT-113, GEN-122
 30-8405..... GEN-122
 30-8500..... CVT-33, CVT-112,
 GEN-87, PED-49, RET-144
 30-9000..... CVT-33, CVT-50,
 PED-3, RET-144
 30-9001..... CVT-33, CVT-50,
 PED-3, RET-144
 30-9002..... CVT-33, CVT-38,
 PED-4, RET-144
 30-9003 CVT-6, CVT-33, PED-2,
 RET-144
 30-9004 CVT-6, CVT-33, PED-2,
 RET-144
 30-9005 CVT-6, CVT-33, PED-2,
 RET-144
 30-9006..... CVT-50, PED-3
 30-9007..... CVT-97, GEN-74,
 PED-16
 30-9008..... CVT-97, GEN-74,
 PED-16
 30-9009..... CVT-97, GEN-74,
 PED-16
 30-9010..... CVT-97, GEN-74,
 PED-16
 30-9011..... CVT-94, PED-3
 30-9025..... CVT-33, RET-144
 31-0401..... NEU-109, O/A-100
 31-0402..... ENT-119, O/A-105
 31-0403..... ENT-119, O/A-105
 31-0502..... ENT-119, O/A-105
 31-0503..... ENT-119, O/A-105
 31-0504..... O/A-102
 31-0552..... ENT-120, O/A-106
 31-0553..... ENT-120, O/A-106
 31-0554..... ENT-120
 31-0605..... CVT-187, O/A-101
 31-0625..... CVT-187, O/A-101
 31-0705..... CVT-187, O/A-101
 31-0706..... O/A-101
 31-0725..... CVT-187, O/A-101
 31-0765..... O/A-101
 31-0811..... O/A-98
 31-0913..... O/A-103
 31-0931..... O/A-96
 31-1003..... ENT-120
 31-1004..... ENT-120
 31-1103..... O/A-95
 31-1104..... O/A-95
 31-1105..... ENT-122, O/A-104
 31-3023..... CVT-187, O/A-103,
 SPN-60
 31-3027..... CVT-187, O/A-103,
 SPN-142
 31-3096..... O/A-102
 31-3097..... O/A-102
 31-3121..... O/A-103, SPN-142
 31-3123..... CVT-187, O/A-103,
 SPN-142
 31-3153..... O/A-102, SPN-141
 31-3183..... CVT-188, O/A-103,
 SPN-141
 31-3193..... O/A-104, SPN-141
 31-5103..... ENT-122, O/A-98
 31-5105..... ENT-122, O/A-98,
 SPN-138
 31-5108..... ENT-122, O/A-98,
 SPN-138
 31-5303..... ENT-122, O/A-98
 31-5305..... ENT-122
 31-5308..... ENT-122
 31-6102..... O/A-97, SPN-137
 32-001..... GEN-156
 32-002..... GEN-156
 32-003..... GEN-156
 32-004..... GEN-156
 32-010..... GEN-156
 32-030..... GEN-156
 32-040..... GEN-156, OBE-38
 32-048..... SPN-191
 32-100..... SPN-195
 32-102..... SPN-194
 32-110..... GEN-152
 32-113..... O/A-110, SPN-191
 32-117-H..... SPN-194
 32-118..... SPN-193
 32-119..... SPN-193
 32-120..... GEN-163
 32-120L..... GEN-163
 32-122..... GEN-329, O/A-112
 32-123..... GEN-329, O/A-112,
 SPN-195
 32-125..... SPN-193
 32-126..... SPN-194
 32-127..... SPN-194
 32-128..... SPN-194
 32-129..... O/A-113, SPN-192
 32-130..... GEN-163
 32-130L..... GEN-163
 32-132..... GEN-151
 32-134..... GEN-151
 32-140..... GEN-163
 32-140L..... GEN-163
 32-145..... GEN-163
 32-150..... GEN-165
 32-152..... GEN-158
 32-153..... GEN-158
 32-155..... GEN-158
 32-156..... GEN-158
 32-157..... GEN-152
 32-159..... GEN-165
 32-160..... GEN-165
 32-170..... GEN-165
 32-172..... GEN-303
 32-176..... GEN-303
 32-180..... GEN-165
 32-185..... GEN-169
 32-190..... GEN-162
 32-191..... GEN-305
 32-192..... GEN-305
 32-193..... GEN-305
 32-200..... GEN-158
 32-210..... GEN-158
 32-230..... GEN-159
 32-230L..... GEN-159
 32-235..... GEN-159
 32-236..... GEN-159, OBE-38
 32-239..... GEN-159
 32-240..... GEN-163
 32-251..... GEN-170
 32-255..... GEN-170
 32-256..... GEN-170
 32-300..... GEN-163, OBE-39
 32-302..... GEN-150, O/A-112,
 SPN-195
 32-303..... GEN-151
 32-304..... GEN-162, OBE-38

32-305.....	GEN-162, OBE-38	32-473.....	GEN-139	32-640.....	GEN-293
32-310.....	GEN-155, OBE-38	32-475.....	GEN-162	32-651.....	GEN-273
32-320.....	GEN-155	32-480.....	GEN-140	32-652.....	GEN-264
32-325.....	GEN-155	32-488.....	GEN-140	32-653.....	GEN-265
32-326.....	GEN-160	32-489.....	GEN-161	32-670.....	GEN-299
32-327.....	GEN-143	32-490.....	GEN-161	32-671.....	GEN-299
32-330.....	GEN-155	32-491.....	GEN-161	32-675.....	GEN-284, OPH-54
32-340.....	GEN-169	32-492.....	GEN-140	32-676.....	GEN-284, OPH-54
32-342.....	GEN-169	32-493.....	GEN-140	32-677.....	GEN-273
32-344.....	GEN-169	32-495.....	GEN-161	32-678.....	GEN-273
32-350.....	GEN-155	32-497.....	GEN-161	32-679.....	GEN-273
32-350L.....	GEN-155	32-500.....	GEN-43	32-681.....	GEN-273
32-352.....	GEN-143	32-501.....	GEN-43	32-682.....	GEN-264
32-360.....	GEN-155	32-502.....	GEN-77	32-683.....	GEN-265
32-365.....	GEN-155	32-503.....	GEN-78	32-684.....	CVT-214
32-366.....	GEN-160	32-504.....	GEN-78	32-685.....	CVT-212, CVT-214
32-368.....	GEN-160, OBE-40	32-505.....	GEN-95	32-686.....	CVT-212, CVT-214
32-400.....	GEN-157	32-506.....	GEN-77	32-690.....	GEN-256
32-400L.....	GEN-157	32-507.....	GEN-77	32-697.....	GEN-256
32-404.....	GEN-166	32-508.....	GEN-109	32-699.....	GEN-273
32-405.....	GEN-171	32-509.....	GEN-78	32-700.....	GEN-299, OPH-62
32-405L.....	GEN-171	32-512.....	GEN-77	32-701.....	GEN-299, OPH-62
32-410.....	GEN-158	32-514.....	GEN-111	32-705.....	GEN-284, OPH-54
32-415.....	GEN-158	32-516.....	GEN-111	32-706.....	GEN-284, OPH-54
32-420.....	GEN-165	32-518.....	GEN-44	32-708.....	GEN-297, OPH-60
32-425.....	GEN-138	32-519.....	GEN-108	32-709.....	GEN-297, OPH-60
32-430.....	GEN-155	32-520.....	CVT-102, GEN-88	32-710.....	GEN-258, GEN-273
32-435.....	GEN-155	32-521.....	GEN-108	32-711.....	GEN-273
32-439.....	GEN-139	32-525.....	GEN-88	32-712.....	GEN-273
32-440.....	GEN-153	32-526.....	GEN-104	32-720.....	GEN-258, GEN-273
32-441.....	GEN-153	32-527.....	GEN-104	32-750.....	GEN-273
32-442.....	GEN-153	32-530.....	GEN-104	32-750L.....	GEN-273
32-444.....	GEN-153	32-531.....	GEN-104	32-751.....	GEN-273
32-446.....	GEN-153	32-532.....	GEN-102	32-752.....	GEN-273
32-449.....	GEN-139	32-535.....	GEN-113	32-760.....	GEN-273
32-450.....	GEN-156	32-536.....	GEN-77	32-790.....	GEN-273
32-451.....	GEN-156	32-550.....	GEN-91	32-790L.....	GEN-273
32-453.....	GEN-156	32-551.....	GEN-75	32-791.....	GEN-273
32-454.....	GEN-154	32-552.....	GEN-75	32-793.....	GEN-273, OBE-75
32-455.....	GEN-154	32-559.....	CVT-103, GEN-89	32-794.....	GEN-279, OBE-75
32-456.....	GEN-154	32-560.....	GEN-89	32-795.....	GEN-273
32-457.....	GEN-154	32-561.....	CVT-103, GEN-89	32-798.....	GEN-279
32-458.....	GEN-154	32-562.....	CVT-103, GEN-89	32-799.....	GEN-279, OBE-76
32-460.....	GEN-170	32-563.....	CVT-103, GEN-89	32-800.....	GEN-264
32-462.....	GEN-154	32-564.....	CVT-103, GEN-89	32-801.....	GEN-264
32-465.....	GEN-167	32-565.....	CVT-103, GEN-89	32-810.....	GEN-265
32-466.....	GEN-167	32-566.....	CVT-103, GEN-89	32-811.....	GEN-265
32-467.....	GEN-167	32-567.....	GEN-93	32-820.....	GEN-264
32-467L.....	GEN-167	32-568.....	GEN-93	32-820L.....	GEN-264
32-467XL.....	GEN-167	32-570.....	GEN-94	32-821.....	GEN-264
32-468.....	GEN-167	32-572.....	ENT-126	32-830.....	GEN-265
32-468S.....	GEN-167	32-575.....	GEN-94	32-830L.....	GEN-265
32-469.....	GEN-167	32-576.....	GEN-94	32-831.....	GEN-265
32-470.....	GEN-139	32-583.....	ENT-125	32-836.....	GEN-264
32-471.....	GEN-139	32-600.....	GEN-293	32-844.....	CVT-210, GEN-304
32-472.....	GEN-167	32-630.....	GEN-293	32-845.....	GEN-304

- 32-846..... CVT-210, GEN-304
32-847..... GEN-304
32-848..... CVT-210
32-860..... GEN-264
32-880..... GEN-279, OBE-76
32-881..... OBE-76
32-882..... GEN-279, OBE-76
32-888..... GEN-283
32-889... GEN-283, OBGYN-44
32-890... GEN-283, OBGYN-44
32-891..... GEN-283, OBE-76
32-892..... GEN-283, OBE-76,
OBGYN-44
32-893..... GEN-283, OBE-76,
OBGYN-44
32-894..... GEN-283
32-895..... GEN-283, OBE-76
OBGYN-44
32-896..... GEN-283, OBE-76,
OBGYN-44
32-898..... GEN-283, OBE-76
OBGYN-44
32-899..... GEN-279, OBE-76
32-900..... GEN-296
32-930..... GEN-257
32-931..... GEN-257
32-940..... ENT-135, GEN-302
32-941..... ENT-135, GEN-302
32-999..... GEN-279, OBE-76
32-1001..... LAP-41
32-1001R..... LAP-41
32-1003..... LAP-36
32-1003R..... LAP-36
32-1206..... LAP-39
32-1500..... LAP-39
32-1800..... LAP-22, GEN-209,
RET-72
32-1800R..... LAP-22, GEN-210
32-1900..... LAP-43
32-2000..... O/A-43, OBE-34,
SPN-64
32-2001..... O/A-43, SPN-64
32-2002..... O/A-43, SPN-64
32-2003..... O/A-43, SPN-64
32-2004..... O/A-43, SPN-64
32-2005..... O/A-43, SPN-64
32-2006..... O/A-43, SPN-64
32-2010..... O/A-43, SPN-64
32-2011..... O/A-43, SPN-64
32-2012..... O/A-43, SPN-64
32-2013..... O/A-43, SPN-64
32-2014..... O/A-43, SPN-64
32-2015..... O/A-43, SPN-64
32-2016..... O/A-43, SPN-64
32-2540..... O/A-45, SPN-66
32-2541..... O/A-45, SPN-66
32-2542..... O/A-45, SPN-66
32-2543..... O/A-45, SPN-66
32-2544..... O/A-45, SPN-66
32-2545..... O/A-45, SPN-66
32-2546..... O/A-45, SPN-66
32-2550..... O/A-45, SPN-66
32-2551..... O/A-45, SPN-66
32-2552..... O/A-45, SPN-65
32-2553..... O/A-45, SPN-65
32-2554..... O/A-45, SPN-65
32-2555..... O/A-45, SPN-65
32-2556..... O/A-45, SPN-65
32-2660..... SPN-64
32-2661..... SPN-64
32-2662..... SPN-64
32-2663..... SPN-64
32-3310..... CVT-64
32-3311..... CVT-63
32-3330..... NEU-56, O/A-58,
SPN-85
32-3337..... CVT-136, GEN-173
32-3339..... CVT-136, GEN-173
32-3341..... CVT-227, SPN-194
32-3345..... CVT-222, SS-47
32-3346..... CVT-222, GEN-313,
SS-47
32-3347..... CVT-222, GEN-313,
SS-47
32-3348..... CVT-222, GEN-313,
SS-47
32-3360..... CVT-224, GEN-323,
OBE-80
32-3361..... CVT-224, GEN-323,
OBE-80
32-3362..... CVT-224, GEN-327,
OBE-80
32-3371..... CVT-227, GEN-328,
O/A-113, SPN-193
32-3372..... CVT-227, GEN-328,
O/A-113, SPN-193
32-3373..... CVT-227, GEN-328,
O/A-113, SPN-193
32-3400..... NEU-6, O/A-14,
SPN-29
32-3401..... NEU-6, O/A-14, SPN-29
32-3402..... NEU-6, O/A-14
32-3403..... NEU-6, O/A-14
32-3404..... NEU-6, O/A-14,
SPN-29
32-3405..... NEU-6, O/A-14,
SPN-29
32-3406..... NEU-6, O/A-14,
SPN-29
32-3407..... NEU-6, O/A-14,
SPN-29
32-3408..... NEU-6, O/A-14,
SPN-29
32-3410..... NEU-8, SPN-33
32-3411..... NEU-8, SPN-33
32-3420..... NEU-25, O/A-19,
SPN-55
32-3422..... O/A-47, SPN-67
32-3423..... O/A-47, OBE-34,
SPN-67
32-3424..... O/A-47, OBE-34,
SPN-67
32-3425..... O/A-47, SPN-67
32-3426..... NEU-107
32-3430..... NEU-61, O/A-64,
SPN-88
32-3431..... NEU-61, O/A-64,
SPN-88
32-3432..... NEU-61, O/A-64,
SPN-88
32-3433..... O/A-64, SPN-88
32-3434..... NEU-61, O/A-64,
SPN-88
32-3435..... NEU-61, O/A-64,
SPN-87
32-3436..... NEU-61, O/A-64,
SPN-87
32-3437..... NEU-61, O/A-64,
SPN-87
32-3438..... NEU-61, O/A-64,
SPN-87
32-3439..... NEU-61, O/A-64,
SPN-87
32-3470..... NEU-7, O/A-15, SPN-31
32-3471..... NEU-7, O/A-15, SPN-31
32-3472..... NEU-7, O/A-15, SPN-31
32-3473..... NEU-7, O/A-15, SPN-31
32-3474..... NEU-7, O/A-15, SPN-31
32-3475..... NEU-7, O/A-15, SPN-31
32-3476..... NEU-7, O/A-15, SPN-31
32-3477..... NEU-7, O/A-15, SPN-31
32-3478..... NEU-7, O/A-15, SPN-31
32-3479..... NEU-7, O/A-15, SPN-31
32-3480..... NEU-7, O/A-15,
SPN-30
32-3481..... NEU-7, O/A-15, SPN-30
32-3482..... NEU-7, O/A-15, SPN-30
32-3483..... NEU-7, O/A-15, SPN-30
32-3484..... NEU-7, O/A-15, SPN-30
32-3485..... NEU-7, O/A-15, SPN-30
32-3486..... NEU-7, O/A-15, SPN-30
32-3487..... NEU-7, O/A-15, SPN-30
32-3488..... NEU-7, O/A-15, SPN-30
32-3489..... NEU-7, O/A-15, SPN-30
32-3490..... NEU-7, O/A-14, SPN-31
32-3491..... O/A-14, SPN-31
32-3492..... NEU-7, O/A-14, SPN-31
32-3493..... NEU-7, O/A-14, SPN-31

32-3494 NEU-7, O/A-14, SPN-31	32-3633 CVT-179,GEN-218, NEU-76, OBE-45, RET-46	32-4091..... GEN-60
32-3495 NEU-7, O/A-14, SPN-31	32-3634 CVT-179, GEN-218, NEU-76, OBE-45	32-4100..... PED-12, GEN-55, CVT-88
32-3496 NEU-7, O/A-14, SPN-31	32-3635 CVT-180, GEN-221, OBE-46, RET-48	32-4110 CVT-120, GEN-60
32-3497 NEU-7, O/A-14, SPN-31	32-3652..... CVT-180, RET-62	32-4111 CVT-120, GEN-60
32-3498 NEU-7, O/A-14, SPN-31	32-3653 RET-62	32-4120 CVT-120, GEN-60
32-3499 NEU-7, O/A-14, SPN-31	32-3654 RET-62	32-4121 CVT-120, GEN-60
32-3514 CVT-47, GEN-15	32-3655 RET-62	32-4130 CVT-120, GEN-60
32-3531 CVT-106, GEN-94, NEU-39	32-3656 RET-62	32-4131 CVT-120, GEN-60
32-3532..... CVT-106, GEN-94, NEU-39, OBE-32	32-3657..... RET-62	32-4141 CVT-119, GEN-57
32-3539 CVT-76, GEN-60, OBE-27	32-3658 RET-62	32-4151 CVT-119, GEN-57
32-3540 CVT-96, GEN-71, OBE-29	32-3659 RET-62	32-4160..... GEN-88, NEU-36
32-3541 CVT-111, GEN-83, OBE-23	32-3660 RET-120	32-4161 GEN-88, NEU-36
32-3542 CVT-97, CVT-110, GEN-83, OBE-30	32-3661..... RET-59, RET-120	32-4290 GEN-60
32-3543 CVT-110, GEN-83, OBE-32	32-3662 RET-59, RET-120	32-5001R LAP-41
32-3544 GEN-82, OBE-30	32-3664 RET-59, RET-120	32-5005 GEN-12
32-3545 GEN-82, OBE-30	32-3665 RET-59, RET-120	32-5015 GEN-12
32-3546 CVT-105, GEN-93, OBE-32	32-3666 RET-59, RET-120	32-5100..... LAP-42
32-3547..... CVT-111, GEN-92, OBE-33	32-3667 RET-59, RET-120	32-5100R LAP-42
32-3548 CVT-71, GEN-26	32-3685 CVT-128, GEN-155, OBE-40	32-5101 LAP-34
32-3549 CVT-102, GEN-89, OBE-31	32-3686 CVT-131	32-5101R LAP-34
32-3550 CVT-103, GEN-122, OBE-31	32-3687 CVT-130, GEN-160, OBE-38	32-5102 LAP-43
32-3551 CVT-76, GEN-82, OBE-23	32-3721 NEU-133	32-5103 LAP-34
32-3552..... CVT-76, GEN-82, OBE-23	32-3722..... NEU-133	32-5104..... LAP-36
32-3553..... CVT-89, GEN-58, OBE-27	32-3868 GEN-164	32-5106..... LAP-42
32-3554 CVT-89, GEN-58, OBE-27	32-3900 CVT-86, GEN-66, PED-15	32-5107 LAP-41
32-3557..... CVT-111, GEN-109, OBE-33	32-3901..... CVT-86, GEN-66, PED-15	32-5107R LAP-41
32-3576..... CVT-193, GEN-303, OBE-71	32-4000..... CVT-86, GEN-66, PED-15	32-5108..... LAP-40
32-3585 CVT-195	32-4001 CVT-86, GEN-66, PED-15	32-5108R LAP-40
32-3592..... CVT-195, GEN-269, OBE-74	32-4011 CVT-88, GEN-57, PED-13	32-5109 LAP-36
32-3593 CVT-195, GEN-269, OBE-74	32-4020 CVT-87, GEN-54, PED-11	32-5109R LAP-36
32-3594 CVT-197, GEN-274, OBE-75	32-4021..... CVT-87, GEN-54, PED-11	32-5110 LAP-34
32-3595 CVT-197, GEN-274	32-4030 CVT-85, GEN-53, PED-11	32-5117..... LAP-35
32-3596 CVT-197, GEN-274, OBE-75	32-4031..... CVT-85, GEN-53, PED-11	32-5127 LAP-44
32-3628 CVT-139, GEN-235, RET-60	32-4040..... CVT-85, GEN-53	32-5127R LAP-44
	32-4041..... GEN-53	32-5137 LAP-44
	32-4043 CVT-114, GEN-83	32-5137R LAP-44
	32-4050 CVT-89, GEN-57	32-5147 LAP-44
	32-4051..... CVT-89	32-5147R LAP-44
	32-4070 GEN-60	32-5157 LAP-35
	32-4071..... GEN-60	32-5158 LAP-35
	32-4080..... GEN-60	32-5158R LAP-35
	32-4081..... GEN-60	32-5200 LAP-38
		32-5201..... LAP-37
		32-5202 LAP-37
		32-5203 LAP-38
		32-5204 LAP-39
		32-5205 LAP-38
		32-5207 LAP-40
		32-5300 LAP-43
		32-5301..... LAP-43
		32-5302 LAP-42
		32-5303 LAP-41
		32-5304 LAP-42
		32-5397..... LAP-25
		32-5399 LAP-25

	PED-6		PED-34	37-1070.....	CVT-19
36-2024.....	CVT-132, GEN-166	36-5032.....	CVT-196, GEN-273	37-1071.....	CVT-19
36-2025.....	CVT-133, GEN-151	36-5033.....	CVT-196, GEN-273	37-1072.....	CVT-19
36-3000.....	CVT-133, GEN-168	36-5034.....	CVT-196, GEN-273	37-1073.....	CVT-19
36-3001.....	CVT-133, GEN-168	36-5035.....	CVT-196, GEN-273	37-1080.....	CVT-40
36-3002.....	CVT-133, GEN-168	36-5040.....	CVT-203, GEN-292,	37-1081.....	CVT-40
36-3003.....	CVT-133, GEN-168		PED-37	37-1086.....	CVT-29
36-3004.....	CVT-133, GEN-168	36-5041.....	CVT-203	37-1091.....	CVT-26
36-3005.....	CVT-133, GEN-168,	36-5050.....	CVT-195, GEN-266,	37-1095.....	CVT-53
	OBE-39		PED-33	37-1096.....	CVT-53
36-3007.....	CVT-132, GEN-168	36-5051.....	CVT-195, GEN-266	37-1097.....	CVT-53
36-3008.....	CVT-132, GEN-168	36-5052.....	CVT-195, GEN-266	37-1100.....	CVT-43
36-3009.....	CVT-132, GEN-168	36-5060.....	CVT-195, GEN-266,	37-1101.....	CVT-43
36-3010.....	CVT-131, GEN-144		PED-33	37-1105.....	CVT-17
36-3011.....	GEN-143	36-5061.....	CVT-195, GEN-266	37-1110.....	CVT-40
36-3012.....	CVT-133, GEN-168	36-5062.....	CVT-195, GEN-266	37-1115.....	CVT-40
36-3013.....	CVT-133, GEN-168	36-5070.....	CVT-207, GEN-278,	37-1120.....	CVT-10
36-3014.....	CVT-133, GEN-168		OBE-75	37-1125.....	CVT-40
36-3015.....	CVT-133, GEN-168	36-5071.....	CVT-207, GEN-278	37-1130.....	CVT-48, OBE-8
36-3018.....	CVT-130, PED-18	36-5080.....	CVT-206, GEN-307	37-1132.....	CVT-34, OBE-28
36-3019.....	CVT-130, GEN-161	36-6000.....	CVT-99, GEN-78,	37-1140.....	CVT-10
36-3020.....	CVT-133, GEN-169		PED-46	37-1141.....	CVT-8, OBE-3
36-3021.....	CVT-133, GEN-169	36-6005.....	CVT-102, GEN-88	37-1142.....	CVT-8, OBE-3
36-3022.....	CVT-132, GEN-168,	36-6007.....	CVT-101, GEN-88	37-1143.....	CVT-8, OBE-3
	PED-20	36-6010.....	CVT-79, GEN-87	37-1150.....	CVT-26
36-3023.....	CVT-133, GEN-168,	36-6015.....	CVT-109, GEN-104	37-1160.....	CVT-39
	PED-20	36-6030.....	CVT-111, GEN-109,	37-1161.....	CVT-39
36-3042.....	CVT-130, GEN-162		PED-48	37-1171.....	CVT-52
36-3043.....	CVT-130, GEN-162	36-6050.....	GEN-82	37-1172.....	CVT-52
36-3045.....	SPN-62	36-6055.....	CVT-104, GEN-91	37-1183.....	CVT-52
36-4000.....	CVT-131, GEN-166,	37-1000.....	CVT-103, GEN-122	37-1190.....	CVT-28
	PED-8	37-1001.....	CVT-103, GEN-122	37-1192.....	CVT-44
36-4010.....	CVT-129, GEN-160	37-1002.....	CVT-103, GEN-122,	37-1193.....	CVT-44
36-4011.....	CVT-132, GEN-166		OBE-31	37-1200.....	CVT-49
36-4015.....	CVT-134, GEN-170	37-1003.....	CVT-103, GEN-122,	37-1201.....	CVT-49
36-4020.....	CVT-134, GEN-171,		OBE-31	37-1202.....	CVT-49
	OBE-39	37-1010.....	CVT-102, GEN-122	37-1221.....	CVT-8
36-5000.....	GEN-285, OPH-54,	37-1011.....	CVT-102, GEN-122	37-1222.....	CVT-8
	PED-35	37-1012.....	CVT-102, GEN-122,	37-1225.....	CVT-6
36-5001.....	GEN-285, OPH-54,		OBE-34	37-1230.....	CVT-7
	PED-35	37-1013.....	CVT-102, GEN-122,	37-1241.....	CVT-42
36-5005.....	GEN-299, PED-40		OBE-34	37-1242.....	CVT-42, GEN-10
36-5010.....	CVT-196, GEN-272	37-1015.....	CVT-10	37-1250.....	CVT-38
36-5011.....	CVT-196, GEN-272	37-1021.....	CVT-11	37-1251.....	CVT-38
36-5015.....	CVT-196, GEN-272	37-1024.....	CVT-13	37-1260.....	CVT-25
36-5016.....	CVT-196, GEN-272	37-1025.....	CVT-11	37-1261.....	CVT-25
36-5017.....	CVT-196, GEN-272	37-1026.....	CVT-12, OBE-3	37-1262.....	CVT-25
36-5020.....	CVT-196, GEN-273	37-1035.....	CVT-18, OBE-4	37-1275.....	CVT-35
36-5021.....	CVT-196	37-1040.....	CVT-20	37-1280.....	CVT-48
36-5022.....	CVT-196, GEN-273	37-1044.....	CVT-20	37-1282.....	CVT-48
36-5023.....	CVT-196	37-1045.....	CVT-20	37-1290.....	CVT-51
36-5024.....	CVT-196	37-1046.....	CVT-20	37-1291.....	CVT-51, PED-3
36-5025.....	CVT-196, GEN-273	37-1053.....	CVT-21	37-1292.....	CVT-51, PED-3
36-5030.....	CVT-196, GEN-273,	37-1054.....	CVT-19	37-1302.....	CVT-8
	PED-34	37-1055.....	CVT-19	37-1305.....	CVT-6, PED-2
36-5031.....	CVT-196, GEN-273,	37-1060.....	CVT-19	37-1310.....	CVT-4

43-0303.....	GEN-176	43-7810.....	GEN-136	45-8002.....	CVT-135
43-0304.....	GEN-176	43-7812.....	GEN-137	46-1019.....	O/A-68, OBE-41,
43-0305.....	GEN-176	43-7813.....	GEN-137		SPN-73, SPN-91
43-0306.....	GEN-176	43-7914.....	GEN-137	46-1020.....	O/A-68, SPN-73,
43-0307.....	GEN-176	43-8501.....	GEN-175		SPN-91
43-0308.....	GEN-176	43-8504.....	GEN-310	46-1021.....	O/A-68, SPN-73,
43-0446.....	GEN-137	43-8505.....	GEN-310		SPN-91
43-0459.....	GEN-18	44-3025.....	GEN-173	46-1022.....	O/A-68, SPN-86
43-0461.....	GEN-18	44-3515.....	GEN-252	46-1023.....	O/A-68, SPN-73,
43-0463.....	GEN-18	44-3715.....	GEN-252		SPN-91
43-0465.....	GEN-18	44-3720.....	GEN-252	46-1024.....	O/A-68, OBE-41,
43-0468.....	GEN-18	44-3730.....	GEN-252		SPN-73, SPN-91
43-0480.....	GEN-18	44-3830.....	GEN-123	46-1025.....	O/A-68, OBE-41,
43-0481.....	GEN-18	45-1800.....	GEN-209, LAP-22,		SPN-73, SPN-91
43-0483.....	GEN-18		RET-72	46-1026.....	O/A-68, SPN-86
43-0483.0.....	GEN-18	45-1800R.....	GEN-210, LAP-22	46-1780.....	CVT-62
43-0483.1.....	GEN-18	45-2140.....	ENT-81	46-2000.....	O/A-67, OBE-41,
43-0483.2.....	GEN-18	45-2141.....	ENT-81		SPN-92
43-0485.....	GEN-18	45-2142.....	ENT-81	46-2001.....	O/A-67, OBE-41,
43-0488.....	GEN-18	45-2143.....	ENT-81		SPN-92
43-0492.....	GEN-18	45-2144.....	ENT-81	46-2002.....	O/A-67, OBE-41,
43-0557.....	GEN-138	45-2145.....	ENT-81		SPN-92
43-0560.....	GEN-138	45-2146.....	ENT-81	46-2003.....	O/A-67, OBE-41,
43-1030.....	CVT-122, GEN-135,	45-2147.....	ENT-81		SPN-92
	NEU-57	45-5104.....	LAP-36	46-2004.....	O/A-67, OBE-41,
43-1032.....	CVT-122, GEN-135,	45-5111.....	ENT-81		SPN-92
	NEU-57	45-5112.....	ENT-81	46-2005.....	O/A-67, OBE-41,
43-1033.....	SS-47	45-5113.....	ENT-81		SPN-92
43-1302.....	GEN-18	45-5114.....	ENT-81	46-2006.....	O/A-67
43-1303.....	GEN-18	45-5115.....	ENT-81	46-2010.....	O/A-67, OBE-41,
43-1304.....	GEN-18	45-5121.....	ENT-81		SPN-92
43-1305.....	GEN-18	45-5122.....	ENT-81	46-2011.....	O/A-67, OBE-41,
43-1306.....	GEN-18	45-5122x.....	ENT-81		SPN-92
43-3812.....	GEN-26	45-5126.....	ENT-81	46-2012.....	O/A-67, OBE-41,
43-4020.....	SS-46	45-5157.....	LAP-35		SPN-92
43-4021.....	SS-46	45-5157R.....	LAP-35	46-2013.....	O/A-67, OBE-41,
43-4022.....	SS-46	45-5158.....	LAP-35		SPN-92
43-4023.....	SS-46	45-5158R.....	LAP-35	46-2014.....	O/A-67, OBE-41,
43-4024.....	SS-46	45-5209.....	LAP-44		SPN-92
43-4025.....	SS-46	45-5300.....	ENT-81	46-2015.....	O/A-67, OBE-41,
43-4026.....	SS-46	45-5302.....	LAP-42		SPN-92
43-4027.....	SS-46	45-5303.....	LAP-41	46-2016.....	O/A-67, OBE-41,
43-4041.....	CVT-85	45-5311.....	ENT-81		SPN-92
43-4043.....	GEN-131	45-5312.....	ENT-81	46-2500.....	O/A-69, SPN-93
43-4077.....	O/A-44	45-5313.....	ENT-81	46-2501.....	O/A-69, SPN-93
43-4500.....	GEN-251	45-5320.....	ENT-81	46-2502.....	O/A-69, SPN-93
43-4501.....	GEN-251	45-5331.....	ENT-82	46-2503.....	O/A-69, SPN-93
43-4600.....	GEN-251	45-5332.....	ENT-82	46-2504.....	O/A-69, SPN-93
43-7081.....	GEN-135	45-5333.....	ENT-82	46-2505.....	O/A-69, SPN-93
43-7082.....	GEN-135	45-5506.....	LAP-28	46-2506.....	O/A-69, SPN-93
43-7083.....	GEN-135	45-5610.....	LAP-37	46-2510.....	O/A-69, SPN-94
43-7313.....	GEN-136	45-5610R.....	LAP-37	46-2511.....	O/A-69, SPN-94
43-7514.....	GEN-136	45-5640.....	LAP-37	46-2512.....	O/A-69, SPN-94
43-7515.....	GEN-136	45-7501.....	GEN-41	46-2513.....	O/A-69, SPN-94
43-7592.....	GEN-136	45-7502.....	GEN-41	46-2514.....	O/A-69, SPN-94
43-7594.....	GEN-137	45-7503.....	GEN-41	46-2515.....	O/A-69, SPN-94

- 46-2516.....O/A-69, SPN-94
46-2601..... NEU-108, SPN-164
46-2602..... NEU-108, SPN-162
46-2603..... NEU-108, SPN-162
46-2605..... NEU-9, SPN-23
46-2606..... NEU-9, SPN-23
46-2607..... NEU-9, SPN-23
46-2608..... NEU-9, SPN-23
46-2609..... NEU-9, SPN-23
46-2610..... NEU-9, SPN-23
46-2611..... NEU-9, SPN-23
46-2612..... NEU-9, SPN-23
46-2613..... SPN-10, SS-42
46-2625..... SPN-81
46-2626..... NEU-8, SPN-17,
SPN-81
46-2627 NEU-8, SPN-17, SPN-81
46-2628 NEU-8, SPN-17, SPN-81
46-2629..... NEU-8, SPN-17,
SPN-81
46-2630..... SPN-38, SPN-81
46-2631 NEU-8, SPN-17, SPN-81
46-2632 NEU-8, SPN-17, SPN-81
46-2633..... NEU-8, SPN-17,
SPN-81
46-2634..... NEU-8, SPN-17,
SPN-81
46-2635..... SPN-38, SPN-81
46-2636..... NEU-8, SPN-17,
SPN-81
46-2637 NEU-8, SPN-17, SPN-81
46-2638..... NEU-8, SPN-17,
SPN-81
46-2639..... NEU-8, SPN-17,
SPN-81
46-2640..... SPN-38, SPN-81
46-2641..... NEU-8, SPN-17
46-2642..... NEU-8, SPN-17,
SPN-81
46-2643..... NEU-8, SPN-17,
SPN-81
46-2644..... NEU-8, SPN-17,
SPN-81
46-2645..... SPN-17, SPN-81
46-2646..... NEU-43, SPN-69,
SPN-81
46-2647..... NEU-43, SPN-69,
SPN-81
46-2648..... SPN-2, SPN-81
46-2810..... CVT-61, GEN-312
46-3002..... SPN-75
46-3003..... NEU-5, SPN-12,
SPN-76, SS-44
46-3005..... SPN-76, SPN-117
46-3006..... SPN-38, SPN-76
46-3007..... SPN-69, SPN-76
46-3008..... SPN-70
46-3009..... SPN-71, SPN-76
46-3011..... SPN-117
46-3012.....
GEN-222, GEN-242, PED-23,
RET-117, SPN-76, SPN-117
46-3013..... PED-43, RET-117,
SPN-189
46-3014..... RET-117, SPN-189
46-3015..... RET-117, SPN-189
46-3020..... SPN-76
46-3021..... SPN-70, SPN-76
46-3022..... SPN-76
46-3026..... SPN-47
46-3027..... SPN-47
46-3028..... SPN-47
46-3037..... SS-39
46-3040..... SPN-62
46-3041..... SPN-62
46-3042..... SPN-62
46-3043..... SPN-62
46-3044..... SPN-62
46-3046..... SPN-62
46-3047..... SPN-62, SS-39
46-3050..... O/A-52, SPN-78
46-3051..... O/A-52, O/A-68,
SPN-78, SPN-92
46-3052..... O/A-52, O/A-68,
SPN-78, SPN-92
46-3053..... O/A-52, O/A-68,
SPN-78, SPN-92
46-3054..... O/A-52, O/A-68,
SPN-78, SPN-92
46-3055..... O/A-52, O/A-68,
SPN-78, SPN-92
46-3056..... O/A-12, O/A-52,
SPN-78
46-3060..... O/A-12, SPN-78,
SS-40
46-3061..... O/A-70, SPN-78,
SPN-94
46-3062..... O/A-70, SPN-78,
SPN-94
46-3063..... O/A-70, SPN-78,
SPN-94
46-3064..... O/A-70, SPN-78,
SPN-94
46-3065..... O/A-70, SPN-78,
SPN-94
46-3066..... O/A-12, SPN-78,
SS-40
46-3070..... O/A-55, SPN-6
46-3071. O/A-55, O/A-6, SPN-6
46-3072 O/A-55, O/A-6, SPN-6
46-3073 O/A-55, O/A-6, SPN-6
46-3074 O/A-55, O/A-6, SPN-6
46-3075 O/A-55, O/A-6, SPN-6
46-3076 O/A-55, SPN-6, SS-40
46-3080..... O/A-54
46-3081..... O/A-54
46-3082..... O/A-54
46-3083. O/A-54, O/A-6, SPN-6
46-3084..... O/A-54
46-3085..... O/A-6, O/A-54
46-3086 O/A-12, O/A-54, SPN-8,
SS-40
46-3100..... SPN-5
46-3101..... SPN-5
46-3102..... SPN-5
46-3103..... SPN-5
46-3104..... SPN-5
46-3105..... SPN-5
46-3106..... SPN-5
46-3107..... SPN-5, SS-39
46-3110..... SPN-5
46-3111..... SPN-5
46-3112..... SPN-5
46-3113..... SPN-5
46-3114..... SPN-5
46-3115..... SPN-5
46-3116..... SPN-5
46-3120..... OBE-12, SPN-75
46-3121..... OBE-12, SPN-23,
SPN-75
46-3122..... SPN-23, SPN-75
46-3123..... OBE-12, SPN-23,
SPN-75
46-3124..... OBE-12, SPN-22,
SPN-75
46-3125..... OBE-12, SPN-22,
SPN-75
46-3126..... OBE-12, SPN-22,
SPN-75
46-3127..... OBE-12, SPN-22,
SPN-75
46-3128..... OBE-12, SPN-22,
SPN-75
46-3129..... OBE-12, SPN-22,
SPN-75
46-3130..... OBE-12, SPN-22,
SPN-75
46-3131..... OBE-12, SPN-22,
SPN-75
46-3132..... OBE-12, SPN-22,
SPN-75
46-3133..... OBE-12, SPN-22,
SPN-75
46-3134..... OBE-12, SPN-22,
SPN-75
46-3135..... OBE-12, SPN-22,
SPN-75
46-3136..... OBE-12, SPN-22,

46-3137.....	OBE-12, SPN-22, SPN-75	46-3196.....	RET-125, SPN-115, SPN-133	46-3242.....	OBE-21, OBE-22, SPN-52, SPN-82
46-3138.....	OBE-12, SPN-22, SPN-75	46-3197.....	RET-125, SPN-111, SPN-115	46-3243.....	OBE-21, OBE-22, SPN-52, SPN-82
46-3139.....	OBE-12, SPN-41, SPN-75	46-3199.....	RET-126, SPN-110	46-3244.....	OBE-21, OBE-22, SPN-52, SPN-82
46-3140.....	OBE-12, SPN-41, SPN-75	46-3200.....	RET-126, SPN-110	46-3245.....	OBE-21, OBE-22, SPN-52, SPN-82
46-3141.....	OBE-12, OBE-36, SPN-68, SPN-75	46-3201.....	RET-126, SPN-110	46-3246.....	OBE-21, OBE-22, SPN-52, SPN-82
46-3142.....	OBE-12, SPN-41, SPN-75	46-3202.....	RET-126, SPN-110	46-3400.....	OBE-17, SPN-77
46-3143.....	OBE-12, SPN-75	46-3203.....	RET-126, SPN-110	46-3401.....	OBE-18, OBE-22, SPN-24, SPN-77
46-3144.....	OBE-12, SPN-75, SPN-96	46-3204.....	RET-126, SPN-110	46-3402.....	OBE-17, OBE-18, OBE-22, SPN-24, SPN-77
46-3145.....	SPN-75, SPN-81, SS-39	46-3205.....	RET-126, SPN-110	46-3403.....	OBE-17, OBE-18, OBE-22, SPN-24, SPN-77
46-3146.....	O/A-59, SPN-85	46-3206.....	SPN-110	46-3404.....	OBE-17, OBE-18, OBE-22, SPN-24, SPN-77
46-3149.....	SPN-19	46-3207.....	SPN-110	46-3405.....	OBE-17, OBE-18, OBE-22, SPN-24, SPN-77
46-3150.....	SPN-16	46-3208.....	SPN-116	46-3406.....	OBE-17, OBE-18, OBE-22, SPN-24, SPN-77
46-3151.....	SPN-16	46-3209.....	SPN-116	46-3407.....	OBE-8, OBE-17, SPN-10, SS-39
46-3152.....	SPN-16	46-3210.....	SPN-116	46-3410.....	OBE-14, SPN-19
46-3153.....	SPN-16	46-3211.....	SPN-116	46-3411.....	OBE-14, OBE-15, SPN-19
46-3154.....	SPN-16	46-3212.....	SPN-116	46-3412.....	OBE-14, OBE-15
46-3155.....	SPN-16	46-3213.....	SPN-116	46-3413.....	OBE-14, OBE-15, SPN-19
46-3156.....	SPN-16	46-3215.....	OBE-18, SPN-24	46-3414.....	OBE-14, OBE-15, SPN-19
46-3157.....	SPN-16	46-3216.....	OBE-18, SPN-24	46-3415.....	OBE-14, OBE-15, SPN-19
46-3158.....	SPN-16	46-3217.....	OBE-18, SPN-24	46-3416.....	OBE-14, OBE-15, SPN-19
46-3159.....	SPN-16	46-3218.....	OBE-18, SPN-24	46-3417.....	OBE-14, OBE-15, SPN-19
46-3160.....	SPN-16	46-3219.....	OBE-18, SPN-24	46-3418.....	OBE-14, OBE-15, SPN-19
46-3161.....	SPN-16	46-3220.....	OBE-18, SPN-24	46-3419.....	OBE-14, OBE-15
46-3162.....	SPN-16	46-3221.....	OBE-18, SPN-24	46-3420.....	OBE-14, OBE-15, SPN-19
46-3163.....	SPN-16	46-3222.....	OBE-9, OBE-16, OBE-18, OBE-21, SPN-12, SS-39	46-3421.....	OBE-14, OBE-15, SPN-19
46-3164.....	SPN-16	46-3225.....	OBE-16	46-3422.....	OBE-14, OBE-15, SPN-19
46-3165.....	SPN-16	46-3226.....	OBE-16, OBE-17, SPN-18, SPN-74	46-3425.....	OBE-21, SPN-54
46-3166.....	SPN-16	46-3227.....	OBE-16, OBE-17, SPN-18, SPN-74	46-3426.....	OBE-21, SPN-54
46-3167.....	SPN-16	46-3228.....	OBE-16, OBE-17, SPN-18, SPN-74	46-3427.....	OBE-21, SPN-54
46-3168.....	SPN-16	46-3229.....	OBE-16, OBE-17, SPN-18, SPN-74	46-3428.....	OBE-21, SPN-54
46-3169.....	SPN-16	46-3230.....	OBE-16, OBE-17, SPN-18, SPN-74	46-3429.....	OBE-21, SPN-54
46-3170.....	SPN-16	46-3231.....	OBE-16, OBE-17, SPN-18, SPN-74	46-3430.....	OBE-21, SPN-54
46-3171.....	NEU-47, SPN-16	46-3232.....	OBE-16, OBE-17, SPN-18, SPN-74	46-3431.....	OBE-21, SPN-54
46-3172.....	NEU-50, SPN-16	46-3233.....	OBE-16, OBE-17, SPN-18, SPN-74	46-3432.....	OBE-21
46-3173.....	SPN-16	46-3234.....	OBE-16, SPN-18, SPN-74	46-3746.....	CVT-63
46-3174.....	SPN-81, SPN-84	46-3235.....	OBE-16, SPN-18, SPN-74	46-3747.....	CVT-63
46-3175.....	SPN-16, SS-39	46-3236.....	OBE-17, SPN-18, SPN-74	46-3748.....	CVT-63
46-3177.....	GEN-132, SPN-84	46-3237.....	OBE-16, OBE-17, SPN-18, SPN-74	46-4000.....	NEU-130, RET-118, SPN-189
46-3178.....	GEN-132, SPN-84	46-3240.....	OBE-21, SPN-82	47-1010.....	SPN-45, SPN-72, SPN-107
46-3179.....	O/A-59, SPN-85	46-3241.....	OBE-21, OBE-22,		
46-3190.....	RET-125, SPN-115				
46-3191.....	RET-125, SPN-115				
46-3192.....	RET-125, SPN-115				
46-3193.....	RET-125, SPN-115, SPN-133				
46-3194.....	RET-125, SPN-115, SPN-133				
46-3195.....	RET-125, SPN-115,				

47-1011	SPN-45, SPN-72, SPN-107	50-0316	GEN-79	50-1160	GEN-241, OBE-65, RET-122, SPN-120
47-1012	SPN-45, SPN-72, SPN-107	50-0319	GEN-79	50-1161	GEN-241, OBE-65, RET-122, SPN-120
47-1013	SPN-45, SPN-72, SPN-107	50-0320	GEN-79	50-1162	GEN-241, OBE-65, RET-122, SPN-120
47-5011	SPN-37, SPN-83	50-0415	GEN-77	50-1163	GEN-241, OBE-65, SPN-120
47-5012	SPN-37, SPN-83	50-0417	GEN-77	50-1165	GEN-240, OBE-66
47-5013	SPN-37, SPN-83	50-0520	GEN-109	50-1166	GEN-243, NEU-82, RET-106
47-5014	SPN-37, SPN-83	50-0616	GEN-99	50-1167	GEN-243, RET-123, SPN-120
47-5015	SPN-37, SPN-83	50-0665	GEN-98	50-1168	GEN-243, RET-123, SPN-120
47-5016	SPN-37, SPN-83	50-0670	GEN-98	50-1180	GEN-239, RET-37, SPN-133
47-5017	SPN-37, SPN-83	50-0715	GEN-85	50-1181	GEN-239, RET-37, SPN-133
47-5018	SPN-37, SPN-83	50-0816	GEN-113	50-1182	GEN-239, RET-37, SPN-133
47-5019	SPN-37, SPN-83	50-1015	GEN-81	50-1186	GEN-240, RET-105
47-5020	SPN-37, SPN-83	50-1016	GEN-81	50-1190	RET-123, SPN-121
47-5021	SPN-40, SPN-83	50-1020	GEN-219, RET-159	50-1191	GEN-246, RET-123, SPN-121
47-5022	SPN-40, SPN-83	50-1022	GEN-219, RET-159	50-1192	RET-123, SPN-121
47-5023	SPN-10, SPN-83, SS-42	50-1023	GEN-81	50-1194	CVT-173, GEN-248, PED-29, RET-70
47-5030	NEU-107, SPN-170	50-1024	GEN-81, OBE-30	50-1195	CVT-173, GEN-248, PED-29, RET-70
47-5031	NEU-107	50-1024-H	OBE-34	50-1196	CVT-173, GEN-248, RET-70
47-5032	NEU-107	50-1036	GEN-4	50-1197	CVT-173, GEN-248, RET-70
47-5033	NEU-107, SPN-170	50-1038	GEN-62	50-1198	CVT-173, GEN-248, RET-70
47-5034	NEU-107, SPN-170	50-1040	GEN-81, OBE-30	50-1199	CVT-173, RET-70
49-4030	GEN-176	50-1045	GEN-81, OBE-30	50-1200	CVT-173, GEN-248, RET-70
49-4031	GEN-176	50-1050	GEN-216, PED-22, RET-135, SPN-109	50-1201	CVT-173, GEN-248, RET-70
49-4032	GEN-176	50-1052	GEN-216, PED-22, RET-135, SPN-109	50-1205	GEN-245, RET-121, SPN-98
49-4033	GEN-176	50-1053	GEN-216, PED-22, RET-135, SPN-109	50-1206	GEN-245, RET-121, SPN-98
49-4035	GEN-176	50-1060	GEN-218, NEU-69	50-1209	GEN-222, RET-133, SPN-73
49-4037	GEN-176, OBE-42	50-1065	GEN-229, RET-123, SPN-121	50-1210	GEN-244, OBGYN-39, RET-62
49-6500	GEN-176, PED-21	50-1066	GEN-229, OBE-65, RET-123, SPN-121	50-1211	GEN-247, RET-124, SPN-121
49-6501	GEN-176, PED-21	50-1067	GEN-229, OBE-65, RET-123, SPN-121	50-1212	GEN-246, PED-25, RET-124, SPN-121
49-6502	GEN-176, PED-21	50-1070	RET-42	50-1220	GEN-244, PED-27, RET-106
49-6503	GEN-176, PED-21	50-1071	RET-42		
49-6504	GEN-176, PED-21	50-1072	RET-42		
49-6505	GEN-176, PED-21	50-1073	RET-42		
50-0008	CVT-62, GEN-312	50-1074	RET-42		
50-0009	GEN-312	50-1075	RET-42		
50-0010	CVT-62, GEN-312	50-1080	SPN-141		
50-0011	GEN-312	50-1085	RET-120, SPN-134		
50-0012	CVT-62, GEN-312	50-1086	SPN-134		
50-0014	CVT-62, GEN-312	50-1100	GEN-248		
50-0016	CVT-62, GEN-312	50-1105	RET-118		
50-0018	CVT-62	50-1106	ENG-58, ENT-30		
50-0020	RET-28	50-1110	SS-18		
50-0021	RET-28	50-1116	GEN-62		
50-0092	SPN-101	50-1120	RET-121, SPN-119		
50-0213	GEN-80	50-1121	SPN-119		
50-0215	GEN-79	50-1123	GEN-62		
50-0216	GEN-79	50-1125	SPN-118		
50-0219	GEN-79	50-1130	SPN-118		
50-0223	GEN-79	50-1131	SPN-118		
50-0224	GEN-79, OBE-30	50-1133	CVT-176, RET-145, SPN-135		
50-0226	GEN-79				
50-0245	GEN-79, OBE-30				
50-0315	GEN-79				

- 50-1223..... GEN-246, RET-67
- 50-1224..... GEN-246, RET-67
- 50-1226..... GEN-245, RET-107
- 50-1227..... GEN-244
- 50-1236..... GEN-247, RET-38
- 50-1249..... SPN-122
- 50-1255..... RET-122, SPN-119
- 50-1270..... GEN-221, SPN-130
- 50-1275..... RET-135, SPN-131
- 50-1291..... GEN-237, RET-134,
SPN-131
- 50-1293..... GEN-237, PED-25,
RET-134, SPN-131
- 50-1310..... PED-25, RET-135,
SPN-131
- 50-1315..... GEN-228, RET-134,
SPN-130
- 50-1316..... GEN-228, RET-134,
SPN-130
- 50-1317..... GEN-228, RET-134,
SPN-130
- 50-1326..... GEN-217, RET-133,
SPN-130
- 50-1331..... GEN-237, OBE-48,
RET-134, SPN-130
- 50-1346..... RET-116, SPN-114
- 50-1356..... PED-28, RET-116,
SPN-114
- 50-1362..... GEN-239, NEU-83,
RET-37, SPN-133
- 50-1363..... GEN-245, NEU-64,
RET-37
- 50-1380..... RET-112, SPN-114
- 50-1381..... RET-113, SPN-111
- 50-1382..... RET-113, SPN-111
- 50-1383..... RET-113, SPN-111
- 50-1384..... RET-113, SPN-111
- 50-1385..... RET-113, SPN-111
- 50-1386..... RET-113, SPN-111
- 50-1387..... RET-113, SPN-111
- 50-1390..... PED-28, RET-112,
SPN-114
- 50-1391..... PED-28, RET-113,
SPN-114
- 50-1392..... PED-28, RET-113,
SPN-114
- 50-1393..... PED-28, RET-113,
SPN-114
- 50-1394..... PED-28, RET-113,
SPN-114
- 50-1395..... PED-28, RET-113,
SPN-114
- 50-1396..... PED-28, RET-113,
SPN-114
- 50-1397..... PED-28, RET-113,
SPN-114
- 50-1453..... CVT-31
- 50-1454..... NEU-81, RET-78,
RET-85
- 50-1460..... NEU-80, RET-78
- 50-1465..... NEU-81, RET-37
- 50-1500..... NEU-70, RET-83
- 50-1507..... NEU-70, NEU-74,
RET-81
- 50-1508..... NEU-70, NEU-75,
RET-81
- 50-1509..... NEU-70, NEU-73,
RET-79
- 50-1511..... NEU-75, RET-80
- 50-1512..... NEU-70, NEU-71,
RET-83
- 50-1513..... NEU-70, NEU-73,
RET-83
- 50-1514..... NEU-71, NEU-76
RET-82, SS-38
- 50-1515..... NEU-73, RET-79
- 50-1516..... NEU-71, RET-80
- 50-1522..... NEU-75, RET-81
- 50-1523..... NEU-72, RET-79
- 50-1524..... NEU-72, RET-79
- 50-1525..... NEU-72, RET-79
- 50-1529..... NEU-72, RET-80
- 50-1530..... NEU-70, NEU-74,
RET-82
- 50-1531..... NEU-70, NEU-74,
RET-82
- 50-1532..... NEU-70, NEU-74,
RET-82
- 50-1533..... NEU-70, NEU-74,
RET-82
- 50-1534..... NEU-70, NEU-74,
RET-82
- 50-1617..... GEN-63
- 50-1651.....
NEU-65, NEU-69, RET-109,
RET-112, SPN-79, SPN-135
- 50-1652.....
NEU-65, NEU-68, RET-109,
RET-111, SPN-79, SPN-135
- 50-1653.....
NEU-65, NEU-68, RET-109,
RET-111, SPN-79, SPN-135
- 50-1654..... NEU-65, NEU-67,
RET-109, SPN-79, SPN-110
- 50-1655..... NEU-65, NEU-67,
RET-109, SPN-79, SPN-110
- 50-1656..... NEU-65, NEU-67,
RET-109, RET-111, SPN-79
- 50-1657.....
NEU-65, NEU-68, RET-109,
RET-111, SPN-79, SPN-190
- 50-1658.....
NEU-65, NEU-68, RET-109,
RET-111, SPN-79, SPN-190
- 50-1659.....
NEU-65, NEU-66, RET-109,
RET-110, SPN-79, SPN-118
- 50-1660.....
NEU-65, NEU-67, RET-109,
RET-110, SPN-79, SPN-132
- 50-1661.....
NEU-65, NEU-67, RET-109,
RET-110, SPN-79, SPN-132
- 50-1662..... NEU-65, RET-109,
SPN-62, SPN-79
- 50-1663..... NEU-65, RET-109,
SPN-61, SPN-79
- 50-1664..... NEU-65,
NEU-68, RET-108, RET-109,
SS-37, SPN-8, SPN-79
- 50-1665..... SPN-39
- 50-1668..... NEU-66, RET-110,
SPN-130
- 50-1670..... NEU-65, SPN-79
- 50-1673..... GEN-62
- 50-1717..... GEN-63
- 50-1773..... GEN-62
- 50-1780..... GEN-4
- 50-1825..... GEN-51
- 50-1837..... SPN-111
- 50-2107..... ENG-59, ENT-31,
LAP-93
- 50-2111..... ENG-59, ENT-31,
LAP-93
- 50-2428..... RET-3
- 50-2558C GEN-224, RET-50
- 50-2608..... GEN-231, RET-55
- 50-3024..... GEN-72
- 50-3028..... GEN-51
- 50-3124..... GEN-72
- 50-3128..... GEN-51
- 50-3172..... GEN-73
- 50-3174..... GEN-73
- 50-3225..... GEN-73
- 50-3325..... GEN-73
- 50-4040C.... GEN-227, RET-147
- 50-4071 CVT-183, GEN-236,
RET-61, SPN-100
- 50-4085..... LAP-23
- 50-4087..... LAP-23
- 50-4089..... LAP-23
- 50-4090 ... CVT-182, GEN-230,
RET-54
- 50-4091..... CVT-182
- 50-4095..... CVT-180, GEN-223,
RET-50
- 50-4100..... CVT-178, GEN-217,
PED-24, RET-44

- 50-4105 CVT-179, GEN-218,
PED-24, RET-45
- 50-4110 CVT-181, GEN-226,
RET-51
- 50-4111 CVT-181, GEN-226,
OBE-49, RET-51
- 50-4112 CVT-181, GEN-226,
OBE-48, RET-51
- 50-4115 CVT-181, GEN-226,
RET-51
- 50-4116 CVT-181, GEN-226,
RET-51
- 50-4117 CVT-181, GEN-226,
OBE-48, RET-51
- 50-4118 CVT-181, GEN-226,
OBE-49, RET-51
- 50-4120 CVT-182, GEN-233,
RET-57
- 50-4121 CVT-182, GEN-233,
RET-57
- 50-4122 GEN-233, OBE-50,
RET-57 CVT-182
- 50-4123C CVT-182, GEN-233,
RET-57
- 50-4124C CVT-182, GEN-233,
RET-57
- 50-4125C CVT-182, GEN-233,
RET-57
- 50-4130C CVT-138, GEN-232,
RET-32
- 50-4131 CVT-138, GEN-232,
RET-32
- 50-4135C CVT-182, GEN-233,
RET-57
- 50-4210 CVT-170, GEN-231,
OBE-50, RET-56
- 50-4212 CVT-170, GEN-231,
OBE-50, RET-56
- 50-4214 CVT-170, GEN-231,
OBE-50, RET-56
- 50-4220CO .CVT-183, GEN-236,
RET-61, RET-68
- 50-4221CO ..CVT-183, GEN-236,
RET-61, RET-68
- 50-4222CO .CVT-183, GEN-236,
RET-61, RET-68
- 50-4223CO GEN-236
- 50-4225CO .CVT-183, GEN-236,
RET-61, RET-68
- 50-4226CO .CVT-183, GEN-236,
RET-61, RET-68
- 50-4227CO... GEN-236, RET-61,
RET-68
- 50-4228CO .CVT-183, GEN-236,
RET-61, RET-68
- 50-4246 GEN-225, RET-50
- 50-4253 CVT-181, GEN-229,
RET-54
- 50-4255 GEN-227, RET-52
- 50-4256 GEN-227, RET-52
- 50-4260 CVT-183, GEN-235,
RET-58
- 50-4261 CVT-183, GEN-235,
RET-58
- 50-4265 GEN-240, RET-64
- 50-4290 CVT-181, GEN-228,
RET-52
- 50-4291 CVT-181, RET-52
- 50-4297 GEN-223
- 50-4303 CVT-179, GEN-221,
OBE-46, RET-47, RET-48
- 50-4304 CVT-179, GEN-221,
OBE-46, RET-47, RET-48
- 50-4306 CVT-179, GEN-221,
OBE-46, RET-47, RET-48
- 50-4307 CVT-179, GEN-221,
OBE-46, RET-47, RET-48
- 50-4308 CVT-179, GEN-221,
OBE-46, RET-47, RET-48
- 50-4309 OBE-46
- 50-4316 CVT-179, GEN-221,
OBE-46, RET-46
- 50-4317 CVT-179, OBE-46,
RET-46
- 50-4319 CVT-179, OBE-46,
RET-46
- 50-4320 CVT-179, GEN-221,
OBE-46, RET-46
- 50-4321 CVT-179, OBE-46,
RET-46
- 50-4350 GEN-249, PED-30,
RET-67
- 50-4351 GEN-249, PED-30
- 50-4400 GEN-183
- 50-4410 GEN-228
- 50-4485 GEN-125, RET-42
- 50-4500 CVT-171, GEN-178,
RET-6
- 50-4503 CVT-171, GEN-182,
RET-6
- 50-4504 RET-5
- 50-4505 GEN-181, RET-5
- 50-4506 GEN-181, RET-5
- 50-4507 CVT-55, CVT-144,
CVT-163, GEN-191, GEN-212,
RET-14, SS-37
- 50-4508
CVT-144, CVT-162, GEN-191,
RET-14, SS-37
- 50-4509 CVT-171
- 50-4510 CVT-171, GEN-183,
RET-7
- 50-4514 CVT-171, GEN-178,
RET-6
- 50-4516 RET-4
- 50-4521 RET-4
- 50-4522 RET-4
- 50-4524 GEN-180, OBE-52,
RET-6
- 50-4526 GEN-181, OBE-44,
RET-5
- 50-4527 GEN-181, OBE-44,
RET-5
- 50-4542 CVT-144, GEN-191,
RET-14
- 50-4546 REC-4, RET-100
- 50-4550 OBE-50
- 50-4551 OBE-50
- 50-4552 CVT-140,
CVT-144, CVT-146-147, CVT-149,
CVT-163, GEN-185, GEN-191,
GEN-193-194, GEN-212, OBE-44,
OBE-50, OBE-60, OBE-62,
RET-8, RET-14, RET-18, RET-20,
RET-35
- 50-4553 CVT-140, GEN-186,
OBE-53, RET-9, RET-17, SPN-113
- 50-4554 CVT-143,
CVT-144, CVT-146, CVT-147,
CVT-149, CVT-162, GEN-190-191,
GEN-193-194, LAP-23, OBE-60,
OBE-62, OBGYN-35, OBGYN-37
, RET-13-15, RET-17-18, RET-20
, RET-35, RET-73, RET-137,
RET-152, SPN-113
- 50-4556 CVT-153, GEN-200,
OBE-58 RET-25
- 50-4557 .CVT-144, CVT-146-147,
CVT-153, CVT-163, GEN-191,
GEN-193,-194, GEN-200, GEN-
212, OBE-60, OBE-62, RET-14,
RET-18, RET-20, RET-25
- 50-4558 CVT-153, GEN-200,
RET-25
- 50-4559 CVT-153, GEN-200,
RET-25
- 50-4560 CVT-153, GEN-200,
RET-25
- 50-4561 CVT-142, CVT-144,
CVT-162, GEN-189, GEN-191,
OBE-55, RET-12, RET-14
- 50-4562 CVT-142, CVT-144,
CVT-162, GEN-189, GEN-191,
RET-12, RET-14
- 50-4563 GEN-187, RET-10
- 50-4565 CVT-141, GEN-187,
RET-10
- 50-4566 CVT-141, CVT-144,

- CVT-162, GEN-187, GEN-191, RET-10, RET-14-15
- 50-4567.....CVT-142, CVT-144, CVT-162, GEN-189, GEN-191, OBE-55, RET-12, RET-14
- 50-4568..... CVT-141, CVT-144, CVT-146-147, CVT-162, GEN-187, GEN-191, GEN-193-194, OBE-60, OBE-62, RET-10, RET-14-15, RET-18, RET-20
- 50-4569..... CVT-141, CVT-144, CVT-146-147, CVT-162, GEN-187, GEN-191, GEN-193-194, OBE-60, OBE-62, RET-10, RET-14-15, RET-18, RET-20
- 50-4570..... CVT-141, CVT-144, CVT-162, GEN-187, GEN-191, RET-10, RET-14, -15
- 50-4571..... CVT-141, CVT-144, CVT-162, GEN-187, GEN-191 OBE-54, RET-10, RET-14-15, RET-17
- 50-4572..... CVT-141, GEN-187, RET-10
- 50-4574..... CVT-141, CVT-145, GEN-187, GEN-192, RET-10, RET-16
- 50-4575..... CVT-141, CVT-145, GEN-187, GEN-192, RET-10, RET-16
- 50-4576..... CVT-141, CVT-144, CVT-162, GEN-186, GEN-191, RET-9, RET-14
- 50-4577..... CVT-143-145, CVT-162, GEN-186, GEN-191-192, RET-9, RET-14-16
- 50-4578..... CVT-145, GEN-192, RET-16
- 50-4579.....CVT-144, CVT-150, CVT-162, GEN-191, GEN-196, OBE-56, RET-14, RET-22
- 50-4580 CVT-144, CVT-146-147, CVT-150, CVT-162, GEN-191, GEN-193-194, GEN-196, OBE-57, OBE-60, OBE-62, OBGYN-37, RET-14-15, RET-17-18, RET-20, RET-22, RET-136, SPN-112
- 50-4581.....CVT-144, CVT-149, CVT-155, CVT-163, GEN-191, GEN-202, GEN-212, OBGYN-39, RET-14, RET-27, RET-35, RET-136, SPN-112
- 50-4582..... CVT-140, CVT-144, CVT-163, GEN-185, GEN-191, GEN-212, OBE-44, OBGYN-35, OBGYN-37, RET-8, RET-14-15, RET-136-137, RET-152, SPN-112-113
- 50-4583.....CVT-144, CVT-154, CVT-163, GEN-191, GEN-201, GEN-212, RET-14-15, RET-26, RET-137, SPN-113
- 50-4584.....CVT-145, CVT-153, GEN-192, GEN-200, REC-4, RET-16, RET-25, RET-100
- 50-4585..... REC-4, RET-100
- 50-4586..... OBGYN-35, REC-4, RET-100, RET-152
- 50-4587..... CVT-154, GEN-201, RET-26
- 50-4588.....CVT-154, OBE-59, GEN-201, RET-17, RET-26, RET-137, SPN-113
- 50-4589.....CVT-150, GEN-197, RET-22
- 50-4590... OBGYN-38, RET-153
- 50-4591 ... OBGYN-36, RET-151
- 50-4592 OBGYN-35, OBGYN-36, RET-151-152
- 50-4593 OBGYN-35, OBGYN-36, RET-151-152
- 50-4594 OBGYN-35, OBGYN-36, RET-151-152
- 50-4595..... CVT-152, GEN-199, OBE-58, RET-24
- 50-4596..... CVT-149, GEN-195, RET-20
- 50-4597..... CVT-141, CVT-149, GEN-188, GEN-195, RET-11, RET-20
- 50-4598..... CVT-141, CVT-149, GEN-188, GEN-195, RET-11, RET-20
- 50-4599..... CVT-141, CVT-149, GEN-188, GEN-195, RET-11, RET-20
- 50-4600 CVT-149, RET-35
- 50-4601.....CVT-149, CVT-160, RET-34-35, RET-74
- 50-4602..... CVT-149, CVT-161, RET-35
- 50-4603..... CVT-149, CVT-161, RET-34-35
- 50-4604.....CVT-55, CVT-149, CVT-161, RET-35, SS-37
- 50-4607.....LAP-23
- 50-4608.....LAP-23
- 50-4609.....LAP-23
- 50-4618 CVT-140, GEN-186, OBE-53, RET-9, RET-17
- 50-4631 RET-136, SPN-112
- 50-4633.....CVT-153, GEN-200, OBE-58, RET-25
- 50-4634.....CVT-153, GEN-200, RET-25
- 50-4635.....CVT-153, GEN-200, RET-25, RET-136, SPN-112
- 50-4636..... CVT-154, GEN-201, OBE-59, RET-15, RET-17, RET-26, RET-136, SPN-112
- 50-4637..... CVT-154, GEN-201, OBE-59, RET-17, RET-26, RET-136, SPN-112
- 50-4638..... CVT-154, GEN-201, OBE-59, RET-26, RET-136, SPN-112
- 50-4639.....GEN-188, RET-11, RET-136, SPN-112
- 50-4640.....GEN-188, RET-11, RET-136, SPN-112
- 50-4641GEN-188, RET-11, RET-136, SPN-112
- 50-4642.....GEN-188, RET-11, RET-136, SPN-112
- 50-4643.....GEN-188, RET-11, RET-136, SPN-112
- 50-4644..... GEN-187, RET-11, RET-136, SPN-112
- 50-4645..... GEN-187, RET-11, RET-136, SPN-112
- 50-4646..... GEN-187, RET-11, RET-136, SPN-112
- 50-4647.....RET-136, SPN-112, SS-37
- 50-4669..... CVT-142, GEN-189, RET-12
- 50-4670..... CVT-142, GEN-189, RET-12
- 50-4671 CVT-142, GEN-189, RET-12
- 50-4672..... CVT-142, OBE-55, RET-12, RET-15
- 50-4673..... CVT-142, GEN-189, OBE-55, RET-12, RET-15
- 50-4674..... CVT-142, GEN-189, OBE-55, RET-12, RET-15
- 50-4675..... CVT-149, CVT-161, RET-34
- 50-4678..... CVT-140, GEN-185, OBE-53, RET-8
- 50-4680.....CVT-155, GEN-202, RET-27
- 50-4681..... CVT-155, GEN-184, RET-8
- 50-4683.....CVT-155, GEN-202, LAP-23, OBGYN-39, RET-27, RET-73
- 50-4684..... CVT-153, GEN-201,

- RET-25
 50-4685..... OBE-37, RET-73
 50-4686..... CVT-150,
 GEN-197, OBE-57, OBGYN-38,
 RET-15, RET-17, RET-23
 50-4687..... OBE-63, RET-24
 50-4688..... OBGYN-35, RET-15,
 RET-28, RET-152, SPN-113
 50-4689..... OBGYN-35,
 RET-152-153
 50-4690... OBGYN-38, RET-153
 50-4691..... CVT-142, GEN-189,
 RET-13
 50-4692... OBGYN-35, RET-152
 50-4694..... CVT-142, GEN-189,
 OBGYN-35, OBGYN-36, RET-12,
 RET-152
 50-4696.....
 CVT-151, GEN-197, OBE-56,
 RET-23, RET-137, SPN-113
 50-4697..... RET-17, RET-28
 50-4698..... OBGYN-38
 50-4797..... CVT-140, GEN-186,
 OBE-53, RET-9
 50-4805..... GEN-211, LAP-23,
 RET-73
 50-4806..... GEN-211, LAP-23,
 RET-73
 50-4807..... GEN-211, RET-73
 50-4808..... GEN-211, LAP-23,
 RET-73
 50-4809..... GEN-211, RET-73
 50-4810..... OBE-63, RET-24
 50-4811..... OBE-63, RET-24
 50-4812..... OBE-63, RET-24
 50-4813..... OBE-63, RET-24
 50-5086..... RET-120
 50-5115..... GEN-237
 50-5220..... GEN-11
 50-5235..... GEN-11
 50-5540... OBGYN-41, RET-155
 50-5541... OBGYN-41, RET-155
 50-5542... OBGYN-41, RET-155
 50-5566..... RET-71
 50-5567..... RET-71
 50-5570... OBE-67, OBGYN-40,
 RET-72, RET-154
 50-5575..... OBE-66, RET-49
 50-5580..... RET-13, RET-137,
 SPN-113
 50-5581..... RET-13, RET-137,
 SPN-113
 50-5582..... RET-13
 50-5583..... RET-13
 50-5584..... RET-13
 50-5587..... RET-137, SPN-113
 50-5588..... RET-137, SPN-113
 50-5589..... RET-137, SPN-113
 50-5608..... CVT-178, GEN-216,
 RET-44
 50-5625..... CVT-168, PED-27,
 RET-104
 50-5629..... CVT-180, RET-48
 50-5630..... CVT-180, GEN-216,
 PED-24, RET-48
 50-5631..... CVT-180, GEN-216,
 PED-24, RET-48
 50-5637..... CVT-170, GEN-231,
 OBE-50, RET-56
 50-5638..... CVT-170, OBE-50
 50-5639..... CVT-170, GEN-231,
 OBE-50, RET-56
 50-5645..... CVT-178, GEN-217,
 PED-24, RET-44
 50-5646..... CVT-173, GEN-248,
 PED-29, RET-70
 50-5647..... CVT-173, PED-29,
 RET-70
 50-5651..... CVT-173, GEN-182,
 PED-29, RET-5
 50-5671..... OBE-65
 50-5710..... RET-15
 50-5720..... RET-17
 50-5730..... LAP-23, RET-73
 50-5740..... RET-137, SPN-113
 50-5960..... SS-7
 50-5961..... SS-7
 50-6536..... GEN-234, OPH-47,
 RET-76
 50-7300..... REC-9
 50-7305..... REC-9
 50-7320-H..... REC-9
 50-7325..... REC-5, RET-99
 50-7420..... REC-6, RET-101
 50-7613..... RET-99
 50-7615..... REC-7, RET-99
 50-7619..... RET-99
 50-7716..... REC-8
 50-7719..... REC-8
 50-8002..... CVT-139
 50-8005..... CVT-139, RET-33
 50-8006..... CVT-139, RET-33
 50-8007..... CVT-139, RET-33
 50-8011..... CVT-139, RET-33
 50-8012..... CVT-138, RET-33
 50-8015..... CVT-167, RET-157
 50-8016..... CVT-177, RET-157
 50-8022..... RET-104
 50-8028..... CVT-16,9 CVT-219,
 RET-104
 50-8031..... CVT-168, RET-103
 50-8033..... CVT-168, RET-103
 50-8055..... CVT-2
 50-8057..... CVT-169, PED-27
 50-8060..... CVT-33, CVT-165,
 PED-24, RET-144
 50-8061..... CVT-33, CVT-165,
 PED-24, RET-144
 50-8064..... CVT-169, RET-105
 50-8065..... RET-105
 50-8066..... CVT-176, PED-30,
 RET-146
 50-8067..... CVT-176, RET-146
 50-8068..... CVT-174, PED-30
 50-8069..... CVT-174
 50-8070..... CVT-175
 50-8072..... CVT-165, GEN-229,
 RET-53
 50-8080..... CVT-175, RET-145
 50-8085..... CVT-177, RET-146
 50-8090..... CVT-176
 50-8093..... REC-2
 50-8096..... CVT-171, GEN-219,
 PED-27, RET-107
 50-8100..... CVT-174
 50-8102..... CVT-174, GEN-224,
 OBE-66
 50-8133..... CVT-168, PED-26,
 RET-103
 50-8135..... REC-2
 50-8152..... GEN-214, RET-74
 50-8153..... CVT-166, GEN-214,
 RET-74
 50-8160..... RET-63
 50-8161..... RET-63
 50-8222..... CVT-168
 50-8500..... SS-6
 50-8501..... SS-6
 50-8502..... SS-6
 50-8503..... SS-6
 50-8504..... SS-6
 50-8505..... SS-6
 50-8506..... SS-6
 50-8507..... SS-6
 50-8508..... SS-6
 50-8509..... SS-6
 50-8510..... SS-6
 50-8511..... SS-6
 50-8512..... SS-6
 50-8513..... SS-6
 50-8514..... SS-6
 50-8550..... SS-6
 50-8551..... SS-6
 50-8552..... SS-6
 50-8726..... SS-5
 50-8727..... SS-5
 50-8728..... SS-5
 50-8729..... SS-5

50-8730.....	SS-5	50-9000.....	SS-8	50-9443.....	REC-3
50-8731.....	SS-5	50-9001.....	SS-8	50-9450.....	REC-4
50-8732.....	SS-5	50-9002.....	SS-8	50-9601.....	REC-8
50-8733.....	SS-5	50-9003.....	SS-8	50-9602.....	REC-8
50-8734.....	SS-5	50-9004.....	SS-8	50-9604.....	REC-6, RET-100
50-8735.....	SS-5	50-9005.....	SS-8	50-9605.....	REC-6, RET-100
50-8736.....	SS-5	50-9006.....	SS-8	50-9606.....	REC-6, RET-100
50-8737.....	SS-5	50-9007.....	SS-8	50-9607.....	REC-6, RET-100
50-8738.....	SS-5	50-9008.....	SS-8	50-9610.....	REC-7
50-8739.....	SS-5	50-9010.....	SS-8	50-9615.....	REC-7
50-8740.....	SS-5	50-9012.....	SS-8	50-9616.....	REC-7
50-8741.....	SS-5	50-9013.....	SS-8	50-9621.....	REC-6, RET-101
50-8742.....	SS-5	50-9014.....	SS-8	50-9622.....	REC-6, RET-101
50-8743.....	SS-5	50-9015.....	SS-8	50-9630.....	REC-8
50-8744.....	SS-5	50-9016.....	SS-8	50-9731.....	ENG-34
50-8745.....	SS-5	50-9017.....	SS-8	50-9749.....	ENG-34
50-8746.....	SS-5	50-9018.....	SS-9	50-9826.....	GEN-316
50-8747.....	SS-5	50-9019.....	SS-9	51-0006.....	CVT-61, GEN-311
50-8748.....	SS-5	50-9020.....	RET-60, SS-9	51-0006B.....	CVT-61, GEN-311
50-8749.....	SS-5	50-9020FO.....	RET-60	51-0006W.....	CVT-61, GEN-313
50-8750.....	SS-5	50-9021.....	RET-60, SS-9	51-0008.....	CVT-61, GEN-311
50-8751.....	SS-5	50-9022.....	SS-9	51-0008B.....	CVT-61, GEN-311
50-8869.....	SS-7	50-9023.....	RET-60, SS-9	51-0008W.....	CVT-61, GEN-313
50-8870.....	SS-7	50-9024.....	RET-60, SS-9	51-0010.....	CVT-61, GEN-311
50-8871.....	SS-7	50-9025.....	RET-60, SS-9	51-0010B.....	CVT-61, GEN-311
50-8872.....	SS-7	50-9025FO.....	RET-60	51-0010W.....	CVT-61, GEN-313
50-8873.....	SS-7	50-9026.....	RET-60, SS-9	51-0012.....	CVT-61, GEN-311
50-8874.....	SS-7	50-9027.....	RET-60, SS-9	51-0012B.....	CVT-61
50-8875.....	SS-7	50-9027FO.....	RET-60	51-0012W.....	CVT-61, GEN-313
50-8876.....	SS-7	50-9028.....	RET-60, SS-9	51-0014.....	CVT-61
50-8877.....	SS-7	50-9029.....	SS-9	51-0014W.....	CVT-61, GEN-311
50-8878.....	SS-7	50-9030.....	SS-9	51-0016.....	CVT-61, GEN-311
50-8879.....	SS-7	50-9031.....	SS-9	51-0601.....	GEN-19
50-8880.....	SS-7	50-9032.....	SS-9	51-0602.....	GEN-19
50-8881.....	SS-7	50-9033.....	SS-9	51-0603.....	GEN-19
50-8882.....	SS-7	50-9034.....	SS-9	51-0604.....	GEN-19
50-8883.....	SS-7	50-9035.....	SS-9	51-0605.....	GEN-19
50-8884.....	SS-7	50-9036.....	SS-9	51-0606.....	GEN-19
50-8885.....	SS-7	50-9037.....	SS-9	51-0607.....	GEN-19
50-8886.....	SS-7	50-9038.....	SS-9	51-0608.....	GEN-19
50-8944.....	SS-7	50-9039.....	SS-9	51-0609.....	GEN-19
50-8945.....	SS-7	50-9040.....	SS-9	51-0610.....	GEN-19
50-8946.....	SS-7	50-9041.....	SS-9	51-0611.....	GEN-19
50-8947.....	SS-7	50-9042.....	SS-9	51-0612.....	GEN-19
50-8948.....	SS-7	50-9043.....	SS-9	51-0613.....	GEN-19
50-8949.....	SS-7	50-9044.....	SS-5, SS-7	51-1066.....	SPN-178
50-8950.....	SS-7	50-9056T.....	CVT-92	51-1085.....	SPN-177
50-8951.....	SS-7	50-9100.....	SS-9	51-1086.....	SPN-177
50-8952.....	SS-7	50-9101.....	SS-9	51-1087.....	SPN-177
50-8953.....	SS-7	50-9409.....	REC-3	51-1088.....	SPN-177
50-8954.....	SS-7	50-9410.....	REC-4	51-1204.....	GEN-308
50-8955.....	SS-7	50-9420.....	REC-3	51-1205.....	GEN-308
50-8956.....	SS-7	50-9438.....	REC-2	51-1406.....	GEN-309
50-8957.....	SS-7	50-9439.....	REC-2	51-1501.....	GEN-309
50-8958.....	SS-7	50-9441.....	REC-3	51-1503.....	GEN-309
50-8959.....	SS-7	50-9442.....	REC-3	51-2519.....	CVT-206

- 51-2523 CVT-206
51-3004 GEN-4
51-3006 GEN-4
51-3369 GEN-42
51-4001 GEN-16
51-4020 GEN-50
51-4301 GEN-50
51-4302 GEN-50
51-5510 OBGYN-33
51-5615 GEN-17
51-5705 URO-4
51-5706 URO-4
51-5735 GEN-9, URO-4
51-5775 GEN-10, URO-4
51-5801 GEN-64, URO-5
51-5802 GEN-64, URO-5
51-5803 GEN-64, URO-5
51-5804 GEN-64, URO-5
51-6308 URO-6
51-6310 URO-6
51-6312 URO-6
51-6314 URO-6
51-6316 URO-6
51-6318 URO-6
51-6320 URO-6
51-6322 URO-6
51-6324 URO-6
51-6326 URO-6
51-6328 URO-6
51-6330 URO-6
51-6332 URO-6
51-6334 URO-6
51-6336 URO-6
51-6350 URO-7
51-6355 URO-7
51-6808 PED-42, URO-6
51-6810 PED-42, URO-6
51-6812 URO-6
51-6814 URO-6
51-6816 URO-6
51-6818 URO-6
51-6820 URO-6
51-6822 URO-6
51-6824 URO-6
51-6826 URO-6
51-6828 URO-6
51-6830 URO-6
51-6832 URO-6
51-6834 URO-6
51-6836 URO-6
51-7008 URO-6
51-7010 URO-6
51-7012 URO-6
51-7014 URO-6
51-7016 URO-6
51-7018 URO-6
51-7020 URO-6
51-7022 URO-6
51-7024 URO-6
51-7026 URO-6
51-7028 URO-6
51-7030 URO-6
51-7110 URO-3
51-7112 URO-3
51-7510 URO-3
51-7530 URO-3
51-7902 URO-5
51-7905 URO-5
51-7910 URO-5
51-8001 GEN-123
51-8002 GEN-16
51-8004 GEN-123
51-8005 GEN-16
51-8006 CVT-136
51-9501 REC-5, RET-98
51-9503 REC-5, RET-98
51-9504 REC-5, RET-98
51-9777 URO-4
51-9910 OBGYN-4
51-9911 OBGYN-3
51-9911B OBGYN-3
51-9913 OBGYN-3
51-9913B OBGYN-3
51-9914 OBGYN-3
51-9914B OBGYN-3
51-9916 OBGYN-3
51-9916B OBGYN-3
51-9921 OBGYN-3
51-9921B OBGYN-3
51-9926 OBGYN-3
51-9926B OBGYN-3
51-9929B OBGYN-3
51-9932 OBGYN-3
51-9932B OBGYN-3
51-9935B OBGYN-3
51-9998 OBGYN-30
51-9999 OBGYN-30
52-0006 CVT-60, CVT-221,
GEN-311
52-0006-3 ... CVT-60, CVT-221
52-0006-4 ... CVT-60, CVT-221
52-0006-6 ... CVT-60, CVT-221
52-0007 CVT-60, CVT-221
52-0007-3 ... CVT-60, CVT-221
52-0008 CVT-60, CVT-221,
GEN-311
52-0008-3 ... CVT-60, CVT-221
52-0008-4 ... CVT-60, CVT-221
52-0008-5 ... CVT-60, CVT-221
52-0010 CVT-60, CVT-221,
GEN-311
52-0010-4 ... CVT-60, CVT-221
52-0010-5 ... CVT-60, CVT-221
52-0010-6 ... CVT-60, CVT-221
52-0012 CVT-60, CVT-221,
GEN-311
52-0012-3 ... CVT-60, CVT-221
52-0012-4 ... CVT-60, CVT-221
52-0012-6 ... CVT-60, CVT-221
52-0014 CVT-60, CVT-221,
GEN-311
52-0014-4 ... CVT-60, CVT-221
52-0014-6 ... CVT-60, CVT-221
52-0016 CVT-60, CVT-221,
GEN-311
52-0016-5 ... CVT-60, CVT-221
52-0018 CVT-60, CVT-221
52-0018-3 ... CVT-60, CVT-221
52-0018-4 CVT-221
52-0018-5 CVT-60
52-0400 OBGYN-52
52-0506 OBGYN-51
52-0507 OBGYN-52
52-0507ES OBGYN-52
52-0508 OBGYN-51
52-0510 OBGYN-52
52-0510ES OBGYN-52
52-0512 OBGYN-52
52-0512ES OBGYN-52
52-0512R OBGYN-51
52-0519 OBGYN-52
52-0519ES OBGYN-52
52-0519R OBGYN-47,
OBGYN-51
52-0542 OBGYN-55
52-0607 OBGYN-48
52-0610 OBGYN-48
52-0610ES OBGYN-49
52-0610-I OBGYN-49
52-0612 OBGYN-48
52-0612ES OBGYN-49
52-0612-I OBGYN-49
52-0619 OBGYN-48
52-0619ES OBGYN-49
52-0620 OBGYN-49
52-0740 OBGYN-55
52-0745 OBGYN-55
52-0755 OBGYN-47, OBGYN-48
52-0755-SI OBGYN-48
52-0760 OBGYN-47
52-0760L OBGYN-48
52-0766 OBGYN-47
52-0767 OBGYN-47
52-0790 OBGYN-41, RET-101
52-0799 OBGYN-41, RET-155
52-0799E ... OBGYN-41, RET-155
52-0799I ... OBGYN-41, RET-155
52-0837 OBGYN-29

52-0838.....	OBGYN-29	52-2958.....	OBGYN-46	52-4625.....	OBGYN-27
52-0839.....	OBGYN-29	52-3016.....	OBGYN-10	52-4635.....	OBGYN-27
52-0840.....	OBGYN-29	52-3017.....	OBGYN-10	52-4674.....	OBGYN-26
52-0842.....	OBGYN-30	52-3019.....	OBGYN-10	52-4706.....	OBGYN-26
52-0849.....	OBGYN-23	52-3020.....	OBGYN-10	52-4726.....	OBGYN-26
52-1005.....	GEN-177	52-3021.....	OBGYN-10	52-4756.....	OBGYN-26
52-1111.....	OBGYN-53	52-3022.....	OBGYN-10	52-5031.....	OBGYN-22
52-1112.....	OBGYN-53	52-3023.....	OBGYN-10	52-5035.....	OBGYN-25
52-1210.....	SPN-153	52-3024.....	OBGYN-10	52-5132.....	OBGYN-22
52-1400.....	OBGYN-2	52-3025.....	OBGYN-10	52-5280.....	O/A-49
52-1410.....	OBGYN-3	52-3026.....	OBGYN-10	52-5300.....	OBGYN-17
52-1475.....	OBGYN-3	52-3280.....	OBGYN-12	52-5301.....	OBGYN-16
52-1510.....	OBGYN-2	52-3501.....	OBGYN-11	52-5302.....	OBGYN-17
52-2001.....	OBGYN-52	52-3503.....	OBGYN-11	52-5303.....	OBGYN-17
52-2002.....	OBGYN-52	52-3505.....	OBGYN-11	52-5304.....	OBGYN-17
52-2003.....	OBGYN-52	52-3507.....	OBGYN-11	52-5305.....	OBGYN-17
52-2020.....	OBGYN-41, RET-156	52-3509.....	OBGYN-11	52-5306.....	OBGYN-17
52-2021.....	OBGYN-41, RET-156	52-3511.....	OBGYN-11	52-5311.....	OBGYN-17
52-2022.....	OBGYN-41, RET-156	52-3513.....	OBGYN-11	52-5322.....	OBGYN-16
52-2100.....	OBGYN-30	52-3515.....	OBGYN-11	52-5500.....	OBGYN-16
52-2221.....	OBGYN-29	52-3517.....	OBGYN-11	52-5510.....	OBGYN-15
52-2301.....	OBGYN-41, RET-155	52-3542.....	OBGYN-11	52-5511.....	OBGYN-15
52-2302.....	OBGYN-41, RET-155	52-3613.....	OBGYN-12	52-5520.....	OBGYN-18
52-2303.....	OBGYN-41, RET-155	52-3617.....	OBGYN-12	52-5521.....	OBGYN-18
52-2331.....	OBGYN-40, RET-154	52-3621.....	OBGYN-12	52-5528.....	OBGYN-4
52-2332.....	OBGYN-40, RET-154	52-3625.....	OBGYN-12	52-5529.....	OBGYN-4
52-2333.....	OBGYN-40, RET-154	52-3629.....	OBGYN-12	52-5554.....	OBGYN-18
52-2340.....	OBGYN-40, RET-49	52-3633.....	OBGYN-12	52-5555.....	OBGYN-18
52-2511.....	OBGYN-51	52-3637.....	OBGYN-12	52-5571.....	OBGYN-15
52-2601.....	OBGYN-40, RET-153	52-3641.....	OBGYN-12	52-5709.....	OBGYN-9
52-2602.....	OBGYN-40, RET-153	52-3642.....	OBGYN-12	52-6503.....	OBGYN-24
52-2603.....	OBGYN-40, RET-153	52-3707.....	OBGYN-9, OBGYN-10	52-6541.....	OBGYN-33
52-2604.....	OBGYN-40, RET-153	52-3709.....	OBGYN-9, OBGYN-10	52-6547.....	OBGYN-32
52-2605.....	OBGYN-40, RET-153	52-3711.....	OBGYN-9, OBGYN-10	52-6549.....	OBGYN-32
52-2606.....	OBGYN-40, RET-153	52-3713.....	OBGYN-9, OBGYN-10	52-6550.....	OBGYN-32
52-2607.....	OBGYN-40, RET-153	52-3715.....	OBGYN-9, OBGYN-10	52-6553.....	OBGYN-14
52-2609.....	OBGYN-40, RET-153	52-3717.....	OBGYN-9, OBGYN-10	52-6554.....	OBGYN-25
52-2610.....	OBGYN-40, RET-153	52-3719.....	OBGYN-9, OBGYN-10	52-6555.....	OBGYN-14
52-2727.....	OBGYN-40, RET-72, RET-154	52-3721.....	OBGYN-9, OBGYN-10	52-6556.....	OBGYN-32
52-2736.....	OBGYN-47	52-3723.....	OBGYN-9, OBGYN-10	52-6557.....	OBGYN-14
52-2737.....	OBGYN-47	52-3725.....	OBGYN-9, OBGYN-10	52-6575.....	OBGYN-13
52-2751.....	OBGYN-39, RET-71	52-3727.....	OBGYN-9, OBGYN-10	52-6610.....	OBGYN-25
52-2752.....	OBGYN-39, RET-71	52-3729.....	OBGYN-9, OBGYN-10	52-6612.....	OBGYN-23
52-2753.....	OBGYN-39, RET-71	52-3742.....	OBGYN-10	52-6666.....	OBGYN-28
52-2770.....	OBGYN-50	52-3840.....	OBGYN-31	52-6881.....	OBGYN-14
52-2786.....	OBGYN-46	52-3950.....	OBGYN-45	52-7010.....	OBGYN-5
52-2787.....	OBGYN-46	52-4001.....	OBGYN-45	52-7015.....	OBGYN-5, OBGYN-23
52-2788.....	OBGYN-46	52-4002.....	OBGYN-45	52-7015E.....	OBGYN-23
52-2793.....	OBGYN-46	52-4033.....	OBGYN-45	52-7030.....	OBGYN-6
52-2793E.....	OBGYN-46	52-4050.....	OBGYN-45	52-7050.....	OBGYN-5
52-2901.....	OBGYN-51	52-4418.....	OBGYN-54	52-7071.....	OBGYN-5
52-2902.....	OBGYN-51	52-4419.....	OBGYN-53	52-7072.....	OBGYN-5
52-2903.....	OBGYN-51	52-4425.....	OBGYN-54	52-7073.....	OBGYN-5
52-2905.....	OBGYN-51	52-4426.....	OBGYN-54	52-7074.....	OBGYN-5
52-2955.....	OBGYN-50	52-4426E.....	OBGYN-54	52-7080.....	OBGYN-7
		52-4575.....	OBGYN-54	52-7501.....	OBGYN-9

52-7502.....	OBGYN-9	52-9992.....	OBGYN-20	53-1158.....	SPN-176
52-7503.....	OBGYN-9	52-9993.....	OBGYN-18	53-1159.....	SPN-147
52-7504.....	OBGYN-9	52-9994.....	OBGYN-18	53-1160.....	SPN-147
52-7505.....	OBGYN-9	52-9995.....	OBGYN-18	53-1161.....	SPN-147
52-7506.....	OBGYN-9	52-9996.....	OBGYN-19	53-1162.....	SPN-147
52-7552.....	OBGYN-7	52-9997.....	OBGYN-19	53-1163.....	SPN-147
52-7554.....	OBGYN-7	52-9998.....	OBGYN-20	53-1164.....	SPN-147
52-7556.....	OBGYN-7	52-9999.....	OBGYN-18	53-1165.....	SPN-147
52-7953.....	OBGYN-7	53-0650.....	OBGYN-13	53-1166.....	SPN-147
52-8000.....	CVT-137	53-0656.....	OBGYN-27	53-1167.....	SPN-147
52-8001.....	CVT-137	53-0657.....	OBGYN-27	53-1171.....	SPN-148
52-8149.....	OBGYN-8	53-1010.....	O/A-100	53-1190.....	SPN-151
52-8150.....	OBGYN-8	53-1011.....	NEU-86, O/A-100, SPN-139	53-1191.....	SPN-151
52-8151.....	OBGYN-8	53-1015.....	NEU-86, O/A-100, SPN-140	53-1192.....	SPN-151
52-8152.....	OBGYN-8	53-1016.....	NEU-86, O/A-100, SPN-140	53-1195.....	SPN-145
52-8153.....	OBGYN-8	53-1030.....	NEU-109, O/A-96	53-1196.....	SPN-145
52-8154.....	OBGYN-8	53-1035.....	NEU-105, SPN-136	53-1197.....	SPN-145
52-8155.....	OBGYN-8	53-1040.....	NEU-105, SPN-136	53-1200.....	SPN-149
52-8156.....	OBGYN-8	53-1045.....	SPN-176	53-1201.....	SPN-148
52-8610.....	OBGYN-6	53-1046.....	NEU-106, SPN-176	53-1202C.....	SPN-149
52-8612.....	OBGYN-6	53-1047.....	NEU-106, SPN-176	53-1211.....	SPN-153
52-8613.....	OBGYN-6	53-1055.....	NEU-105	53-1212.....	SPN-153
52-8614.....	OBGYN-6	53-1060.....	NEU-106, SPN-137	53-1220.....	SPN-148
52-8615.....	OBGYN-6	53-1061.....	NEU-106, SPN-137	53-1221.....	SPN-148
52-8616.....	OBGYN-6	53-1066.....	NEU-106, OBE-68, SPN-137	53-1222.....	SPN-148
52-8666.....	OBGYN-6	53-1067.....	SPN-137	53-1223.....	SPN-148
52-8990.....	OBGYN-2	53-1080.....	NEU-107	53-1224.....	PED-31, SPN-148
52-8991.....	OBGYN-2	53-1081.....	NEU-107, SPN-141	53-1225.....	SPN-148
52-8992.....	OBGYN-2	53-1083.....	NEU-107, SPN-141	53-1226.....	GEN-97
52-9000.....	OBGYN-51	53-1084.....	NEU-107, SPN-141	53-1230.....	SPN-145
52-9007E.....	OBGYN-27	53-1085.....	NEU-107, SPN-141	53-1232.....	SPN-145
52-9010.....	OBGYN-28	53-1095.....	NEU-87, O/A-104, SPN-142	53-1233.....	SPN-145
52-9010E.....	OBGYN-28	53-1100.....	NEU-85, O/A-95, SPN-136	53-1235.....	SPN-149
52-9011.....	OBGYN-28	53-1102.....	NEU-85, O/A-99, SPN-139	53-1236.....	SPN-148
52-9125.....	OBGYN-31	53-1108.....	NEU-85, O/A-99, SPN-139	53-1237.....	SPN-149
52-9140.....	OBGYN-42	53-1118.....	CVT-187, NEU-87, O/A-104, OBE-68, SPN-141	53-1240.....	SPN-153
52-9141.....	OBGYN-42	53-1125.....	NEU-106, SPN-177	53-1241.....	SPN-153
52-9301.....	GEN-314	53-1126.....	NEU-106, SPN-177	53-1242.....	SPN-153
52-9303.....	GEN-314	53-1127.....	NEU-106, SPN-177	53-1250.....	SPN-146
52-9305.....	GEN-314	53-1128.....	NEU-106, SPN-177	53-1251.....	SPN-146
52-9307.....	GEN-314	53-1130.....	NEU-87, O/A-104, SPN-141	53-1252.....	SPN-146
52-9896.....	OBGYN-19	53-1131.....	NEU-87, O/A-104, SPN-141	53-1255.....	PED-31, SPN-151
52-9897.....	OBGYN-19	53-1133.....	CVT-187, NEU-87, O/A-104, OBE-68, SPN-141	53-1258.....	SPN-152
52-9966.....	OBGYN-19	53-1157.....	SPN-176	53-1262.....	SPN-150
52-9967.....	OBGYN-18			53-1280.....	PED-32, SPN-154
52-9970.....	OBGYN-19			53-1281.....	PED-32, SPN-154
52-9972.....	OBGYN-19			53-1282.....	SPN-154
52-9973.....	OBGYN-19			53-1290.....	PED-31
52-9984.....	OBGYN-19			53-1291.....	PED-31, SPN-145
52-9985.....	OBGYN-19			53-1292.....	SPN-145
52-9986.....	OBGYN-19			53-1295.....	SPN-149
52-9987.....	OBGYN-19			53-1296.....	SPN-148
52-9988.....	OBGYN-19			53-1297.....	SPN-149
52-9989.....	OBGYN-19			53-1300.....	PED-32, SPN-152
52-9990.....	OBGYN-20			53-1310.....	NEU-87, O/A-102, SPN-140
52-9991.....	OBGYN-20				

53-1311.....NEU-87, O/A-102, SPN-140	53-1504.....NEU-93, SPN-174	53-1648LED..... SPN-181
53-1312.....NEU-87, O/A-102, SPN-140	53-1505.....NEU-93, SPN-173	53-1651LED..... SPN-181
53-1313.....NEU-87, O/A-102, SPN-140	53-1507.....NEU-93, SPN-174	53-1654LED..... SPN-181
53-1325.....PED-31, SPN-151	53-1508.....NEU-93, SPN-173	53-1660.....SPN-187
53-1326.....PED-31, SPN-151	53-1509.....NEU-92, SPN-172	53-2062.....SPN-146
53-1370.....PED-32, SPN-138	53-1510.....NEU-93, SPN-174	53-2312.....OBGYN-9
53-1371.....PED-32, SPN-138	53-1511.....NEU-93, SPN-173	53-3118.....OBGYN-43
53-1372.....SPN-138	53-1512.....NEU-92, SPN-173	53-3180-BD.....SPN-158
53-1373.....SPN-138	53-1513.....NEU-93, SPN-174	53-4000.....NEU-108
53-1374.....PED-32, SPN-176	53-1514.....NEU-93, SPN-173	53-4002.....NEU-108
53-1375.....PED-32, SPN-176	53-1515.....NEU-92, SPN-173	53-4005.....NEU-35, PED-14
53-1376.....SPN-176	53-1516.....NEU-93, SPN-174	53-4006.....NEU-35, PED-14
53-1377.....SPN-176	53-1517.....NEU-93, SPN-173	53-4007.....NEU-35, PED-14
53-1380.....PED-31, SPN-175	53-1518.....NEU-92, SPN-173	53-4008.....NEU-35, PED-14
53-1381.....PED-31, SPN-175	53-1519.....NEU-93, SPN-174	53-4009.....NEU-35
53-1382.....PED-31, SPN-175	53-1520.....NEU-93, SPN-173	53-4010.....NEU-35
53-1383.....SPN-175	53-1521.....NEU-92, SPN-173	53-4613.....NEU-35
53-1385.....SPN-138	53-1522.....NEU-93, SPN-174	53-5035.....OBGYN-21
53-1386.....SPN-138	53-1523.....NEU-93, SPN-173	53-5041.....OBGYN-21
53-1387.....SPN-138	53-1524.....NEU-92, SPN-173	53-5056.....OBGYN-21
53-1388.....SPN-138	53-1525.....NEU-93, SPN-174	53-5061.....OBGYN-21
53-1402.....SPN-160	53-1526.....NEU-93, SPN-174	53-5066.....OBGYN-22
53-1403.....SPN-160	53-1527.....NEU-92, SPN-173	53-5075.....OBGYN-20
53-1404.....SPN-160	53-1528.....NEU-93, SPN-174	53-7005.....OBGYN-6
53-1405.....SPN-160	53-1529.....NEU-93, SPN-174	53-7010.....OBGYN-6
53-1406.....SPN-160	53-1530.....NEU-92, SPN-173	53-7025.....OBGYN-6
53-1407.....SPN-160	53-1531.....NEU-93, SPN-174	53-7030.....OBGYN-6
53-1408.....SPN-160	53-1532.....NEU-93, SPN-174	53-7502.....OBGYN-23
53-1409.....SPN-160	53-1533.....NEU-92, SPN-173	54-0002.....CVT-84
53-1410.....SPN-160	53-1534.....NEU-93, SPN-174	54-0003.....CVT-84
53-1411.....SPN-160	53-1535.....NEU-93, SPN-174	54-0004.....CVT-84
53-1412.....SPN-160	53-1537.....NEU-92, SPN-172	54-0005.....CVT-84
53-1413.....SPN-160	53-1539.....NEU-92, SPN-172	54-0006.....CVT-84
53-1414.....SPN-160	53-1540CD...NEU-102, SPN-175	54-0008.....CVT-78
53-1415.....SPN-161	53-1542CD...NEU-102, SPN-175	54-0009.....CVT-197
53-1416.....SPN-161	53-1544CD...NEU-102, SPN-175	54-0010.....CVT-134
53-1417.....SPN-160	53-1546.....NEU-95	54-0192.....RET-144
53-1418.....SPN-161	53-1546CD...NEU-102, SPN-175	54-0194.....RET-144
53-1419.....SPN-161	53-1548CD...NEU-102, SPN-175	54-1000.....CVT-186, PED-30
53-1420.....SPN-160	53-1550CD...NEU-102, SPN-175	54-1003.....CVT-175, RET-145
53-1421.....SPN-161	53-1552CD...NEU-102, SPN-175	54-1005.....GEN-283, NEU-114
53-1422.....SPN-161	53-1554CD...NEU-102, SPN-175	54-1006.....GEN-283, NEU-114, RET-145
53-1423.....SPN-160	53-1570CD...NEU-102, SPN-175	54-1009.....CVT-165, PED-25, RET-145
53-1424.....SPN-161	53-1572CD...NEU-102, SPN-175	54-1010.....CVT-203, GEN-278
53-1425.....SPN-161	53-1574CD...NEU-102, SPN-175	54-1015.....GEN-290, NEU-117
53-1426.....OBE-69, SPN-161	53-1576CD...NEU-102, SPN-175	54-1019.....CVT-216
53-1427.....SPN-161	53-1612LD.....SPN-181	54-1020.....CVT-197
53-1428.....OBE-69, SPN-161	53-1615LED.....SPN-181	54-1021.....CVT-197, GEN-274
53-1429.....OBE-69, SPN-161	53-1618LED.....SPN-181	54-1023.....CVT-197, GEN-274, PED-34
53-1500C.....NEU-92, SPN-172	53-1624LD.....SPN-181	54-1026.....CVT-197, GEN-274
53-1501.....NEU-93, SPN-174	53-1627LED.....SPN-181	54-1027.....CVT-197, GEN-274
53-1502.....NEU-93, SPN-173	53-1630LED.....SPN-181	54-1030.....CVT-197, GEN-274
53-1503.....NEU-92, SPN-172	53-1633LED.....SPN-181	54-1034.....CVT-197, GEN-274
	53-1636LED.....SPN-181	
	53-1642LD.....SPN-181	
	53-1645LED.....SPN-181	

- 54-1037..... CVT-197, GEN-274,
OBE-76
- 54-1041.....GEN-258, NEU-120
- 54-1046 GEN-291
- 54-1050 GEN-291, NEU-114,
PED-34
- 54-1055.....GEN-281, NEU-114
- 54-1075.....CVT-199, GEN-256,
PED-35
- 54-1076.....CVT-199, GEN-256,
PED-35
- 54-1081.....ENT-135
- 54-1091..... NEU-118, PED-38
- 54-1234.....CVT-216
- 54-1525..... CVT-217
- 54-1795..... GEN-238, RET-102
- 54-1797..... GEN-238, RET-102
- 54-1860 RET-145
- 54-2100 CVT-168, RET-103
- 54-2101.....CVT-168, PED-26,
RET-103
- 54-2220CVT-218
- 54-2241..... CVT-220
- 54-2242 CVT-220
- 54-2301.....CVT-219
- 54-2302CVT-219
- 54-2303CVT-219
- 54-2340 CVT-166, RET-146
- 54-2343CVT-219
- 54-2343B.....CVT-219
- 54-2402CVT-219
- 54-2403CVT-219
- 54-2404CVT-219
- 54-2515..... CVT-192, GEN-259,
PED-33
- 54-2520CVT-192
- 54-2530CVT-2, PED-2
- 54-2550CVT-206, GEN-295
- 54-2550S..... CVT-2
- 54-2555 CVT-205, PED-39
- 54-3001 CVT-137, PED-22
- 54-3002..... CVT-137, PED-22
- 54-3012..... CVT-137
- 54-3130..... CVT-137
- 54-3134..... CVT-137, PED-22
- 54-3135..... CVT-137
- 54-3140 CVT-137
- 54-3505CVT-166
- 54-3520CVT-166
- 54-3524CVT-166
- 54-3550 CVT-171, RET-107
- 54-4001 CVT-137
- 54-4002..... CVT-137
- 54-4003..... CVT-137
- 54-4006..... CVT-137
- 54-4012 CVT-189, GEN-254
- 54-4013 CVT-189, GEN-254
- 54-4017 CVT-205, GEN-295,
PED-39
- 54-4023.... CVT-194, GEN-262
- 54-4026.... CVT-204, GEN-293,
PED-38
- 54-4027 CVT-204, GEN-293,
PED-38
- 54-4028.... CVT-204, GEN-293,
PED-38
- 54-4029.... CVT-204, GEN-294,
PED-38
- 54-4030.... CVT-204, GEN-294,
PED-38
- 54-4032.... CVT-204, GEN-294,
PED-38
- 54-4034....CVT-204, GEN-294
- 54-4035....CVT-204, GEN-294
- 54-4066....CVT-203, GEN-291,
PED-37
- 54-4075 CVT-196, GEN-270
- 54-4076.....GEN-270
- 54-4078.....CVT-196
- 54-4080.....CVT-193
- 54-4080C..... GEN-252
- 54-4080SCVT-194
- 54-4085.....CVT-194
- 54-4088.... CVT-195, GEN-266
- 54-4090.... CVT-195, GEN-265
- 54-4092.... CVT-195, GEN-266
- 54-4095.... CVT-195, GEN-266
- 54-4097.... CVT-195, GEN-266
- 54-4098....GEN-266, PED-34
- 54-4099....CVT-195, GEN-266,
PED-34
- 54-4105 CVT-195, GEN-266
- 54-4110..... CVT-216, GEN-307,
PED-42
- 54-4151 CVT-194, GEN-262
- 54-4180-BDSPN-158
- 54-4192.... CVT-189, GEN-254
- 54-4205.... CVT-205, GEN-295,
PED-39
- 54-4210 CVT-215, GEN-307,
PED-42
- 54-4300.... CVT-203, GEN-293,
PED-38
- 54-4301CVT-203,GEN-293,
PED-38
- 54-4306.... CVT-203, GEN-293,
PED-38
- 54-4709CVT-76
- 54-4900..... CVT-75, GEN-26
- 54-4905..... CVT-75, GEN-26
- 54-5000..... CVT-117, GEN-76
- 54-5001 CVT-54, GEN-7
- 54-5002..... CVT-75, GEN-26
- 54-5003..... CVT-117, GEN-76
- 54-5004.....CVT-117
- 54-5005.....CVT-118, GEN-99
- 54-5006..... CVT-117, GEN-98
- 54-5007..... CVT-117, GEN-98
- 54-5009..... CVT-115, GEN-85
- 54-5010 CVT-115, GEN-85
- 54-5011..... CVT-115, GEN-85
- 54-5012.....CVT-117
- 54-5014CVT-117
- 54-5019 CVT-91, GEN-64
- 54-5021..... CVT-115, GEN-85
- 54-5085C GEN-252
- 54-5098..... CVT-195
- 54-5180-BD.....SPN-158
- 54-5500 .GEN-302, OBGYN-44
- 54-5503 .GEN-302, OBGYN-44
- 54-5526 ..GEN-282, OBGYN-42
- 54-5535 CVT-195, GEN-266
- 54-5545 .GEN-302, OBGYN-43
- 54-5566 CVT-193, GEN-259,
PED-33
- 54-5567 CVT-192, GEN-259,
PED-33
- 54-5571.....CVT-193, GEN-263,
PED-33
- 54-5573 CVT-193, GEN-271
- 54-5578 .GEN-302, OBGYN-44
- 54-5579 ..GEN-282, OBGYN-42
- 54-5604.....CVT-202, NEU-117,
PED-36
- 54-5605CVT-202, NEU-117,
PED-36
- 54-5606.....CVT-202, NEU-117,
PED-36
- 54-5607 NEU-117
- 54-5608..... NEU-117
- 54-5609..... NEU-117
- 54-5751.....GEN-41
- 54-5752GEN-41
- 54-5998 CVT-3, GEN-3
- 54-6000 CVT-135, GEN-172
- 54-6013 CVT-225
- 54-6016 CVT-135, GEN-172
- 54-6038..... CVT-225
- 54-6500.....PED-35
- 54-6503.....PED-35
- 54-6513..... GEN-300, PED-41
- 54-6515..... GEN-299, PED-40
- 54-6517..... GEN-299, PED-40
- 54-6520ENT-134, GEN-298,
PED-41
- 54-6521.....ENT-134, GEN-298,
PED-41
- 54-6522ENT-134, GEN-298,

	PED-41		
54-6523	ENT-134, GEN-298, PED-41	54-8070	CVT-191
54-6524	ENT-127, GEN-287, OPH-57, PED-36	54-8073	CVT-191
54-6525	ENT-127, GEN-287, OPH-57, PED-36	54-8074	CVT-191
54-6526	ENT-127, GEN-287, OPH-57, PED-36	54-8075	CVT-191
54-6527	ENT-127, GEN-287, OPH-57, PED-36	55-0010T	GEN-145
54-6624	CVT-205, GEN-295, PED-39	55-0015T	GEN-145
54-6630	CVT-205, GEN-295, PED-39	55-0020T	GEN-145
54-7003	CVT-225	55-0030T	GEN-145
54-7004	CVT-225	55-0120T	GEN-148
54-7005	CVT-225	55-0130T	GEN-148
54-7007	CVT-225	55-0140T	GEN-148
54-7249	CVT-95	55-0322T	GEN-149
54-7255	CVT-30, GEN-93	55-0352T	GEN-149
54-7256	CVT-30, GEN-93	55-0362T	GEN-149
54-7257	CVT-30, GEN-93	55-0366T	GEN-145
54-7258	CVT-30, GEN-93	55-0466T	GEN-150
54-7259	CVT-30, GEN-93	55-1001	CVT-190
54-7260	CVT-118, GEN-99	55-1002	CVT-190
54-7262	CVT-93, GEN-93	55-1007	CVT-213
54-7266	CVT-95, GEN-93, OBE-26	55-1009	CVT-213
54-7275	CVT-95, GEN-90	55-1010	CVT-213
54-7277	CVT-95, GEN-90	55-1012	GEN-296
54-8002	CVT-211, CVT-213	55-1013	GEN-296
54-8003	CVT-211, CVT-213	55-1014	GEN-296
54-8004	CVT-211, PED-41	55-1026	CVT-190
54-8005	CVT-207	55-1027	CVT-190
54-8006	CVT-207	55-1028	CVT-190
54-8008	CVT-199, PED-41	55-1029	CVT-190
54-8010	CVT-190	55-1032	CVT-212, CVT-213
54-8011	CVT-191	55-1033	CVT-212, CVT-213
54-8012	CVT-198	55-1108	CVT-190
54-8014	CVT-191	55-1207	CVT-213
54-8016	CVT-202	55-1208	CVT-213
54-8017	CVT-190, GEN-254	55-1209	CVT-213
54-8018	CVT-190, GEN-254	55-1210	CVT-213
54-8019	CVT-190, GEN-254	55-1317	CVT-197
54-8020	CVT-190, GEN-254	55-1318	CVT-197
54-8021	CVT-190, GEN-254	55-1319	CVT-197
54-8023	CVT-202, GEN-304, OBE-77	55-1320	CVT-197
54-8024	CVT-189, GEN-301	55-1350	CVT-189
54-8025	CVT-197, GEN-279	55-1350L	CVT-189
54-8035	CVT-208	55-1351	CVT-189
54-8036	CVT-208	55-1355	CVT-215
54-8037	CVT-208	55-1374	CVT-198
54-8040	CVT-215	55-1512	CVT-208
54-8055	CVT-215	55-1514	CVT-208
		55-1526	CVT-208
		55-1531	CVT-210
		55-1532	CVT-210
		55-1534	CVT-210
		55-1536	CVT-210
		55-1539	CVT-210
		55-1540	CVT-209
		55-1540F	CVT-209
		55-2000	CVT-113, GEN-120
		55-2004	CVT-112, GEN-121
		55-2004T	CVT-114, GEN-114
		55-2005	CVT-112, GEN-121
		55-2005T	CVT-114, GEN-114
		55-2006	CVT-112, GEN-121
		55-2006T	CVT-114
		55-2007	CVT-113, GEN-120
		55-2007T	CVT-114, GEN-114
		55-2008	CVT-113, GEN-120
		55-2008I	CVT-114
		55-2008T	CVT-114, GEN-114
		55-2009	CVT-113, GEN-120
		55-2009E	CVT-114
		55-2009T	CVT-114, GEN-114
		55-2010	CVT-113, GEN-120
		55-2015	CVT-113, GEN-120
		55-2016	CVT-113, GEN-120
		55-2017	CVT-113, GEN-120
		55-2018	CVT-113, GEN-120
		55-2019	CVT-113, GEN-120
		55-2020	CVT-113, GEN-120
		55-2021	CVT-113, GEN-120
		55-2022	CVT-112, GEN-119
		55-2023	CVT-112, GEN-119
		55-2024	CVT-112, GEN-119
		55-2026	CVT-112, GEN-119
		55-2027	CVT-112, GEN-119
		55-2030	CVT-113, GEN-120
		55-2040	CVT-113, GEN-120
		55-2050T	CVT-119, GEN-105
		55-2065	CVT-113, GEN-120
		55-2075	CVT-113, GEN-120
		55-2270	CVT-194, GEN-263
		55-2280	CVT-194, GEN-263
		55-2423	CVT-126, GEN-140
		55-2423T-F	GEN-146
		55-2424T	GEN-146
		55-2500	CVT-125, GEN-141
		55-2510	CVT-125, GEN-141
		55-2513	GEN-144
		55-2515	GEN-144
		55-2518	GEN-144
		55-2519	GEN-144
		55-2520	GEN-144
		55-2521	GEN-144
		55-2522	GEN-144
		55-2523	CVT-126, GEN-140
		55-2523T	GEN-147
		55-2523T-F	GEN-146
		55-2524	CVT-126, GEN-140
		55-2524T	GEN-146
		55-2525	CVT-126, GEN-140
		55-2525T	GEN-147
		55-2525T-F	GEN-146
		55-2526	CVT-126
		55-2526T	GEN-146
		55-2527	CVT-126, GEN-140,

	GEN-142			
55-2528	CVT-126, GEN-140		
55-2529T	GEN-147		
55-2530	CVT-126, GEN-140		
55-2530T	GEN-146		
55-2531	CVT-126, GEN-140		
55-2531T	CVT-126, GEN-146		
55-2531T-F	CVT-126, GEN-146		
55-2532	CVT-126, GEN-140		
55-2533	CVT-123, GEN-153		
55-2533T	GEN-145		
55-2533T-F	GEN-145		
55-2534	CVT-123, GEN-153		
55-2534T	GEN-145		
55-2535	CVT-126		
55-2536	CVT-126, GEN-140		
55-2538T	GEN-145		
55-2540	GEN-141		
55-2541	GEN-141		
55-2543T	GEN-146		
55-2543T-F	GEN-146		
55-2547	CVT-124, GEN-141		
55-2549	CVT-124, GEN-140, GEN-142		
55-2550	CVT-124, GEN-141		
55-2555	CVT-124, GEN-141		
55-2555T	CVT-125, GEN-147		
55-2555T-F	CVT-125, GEN-146		
55-2556T	CVT-125, GEN-146		
55-2557T	CVT-125, GEN-146, GEN-147		
55-2558T	CVT-125, GEN-146		
55-2560	CVT-124, GEN-141		
55-2560T	CVT-125, GEN-146		
55-2560T-F	CVT-125, GEN-146		
55-2565	CVT-124, GEN-141		
55-2565T	CVT-125, GEN-146		
55-2566	CVT-124, GEN-141		
55-2570	CVT-128, GEN-157		
55-2604	CVT-125, GEN-138		
55-2608	CVT-125, GEN-138		
55-2610	CVT-125, GEN-138		
55-2612	CVT-125, GEN-138		
55-2660	CVT-132, GEN-167		
55-2662	CVT-132, GEN-167		
55-2664	CVT-132, GEN-167		
55-2727	CVT-123		
55-2728	CVT-123, GEN-142		
55-3200	CVT-123		
55-3531	CVT-42		
55-3532	CVT-42		
55-3533	CVT-42, PED-4		
55-3534	CVT-42, PED-4		
55-3925	CVT-37		
55-4002	CVT-27		
55-4004	CVT-27		
55-4006	CVT-27		
55-4010	CVT-27		
55-4011	CVT-21		
55-4012	CVT-21		
55-4013	CVT-21		
55-4015	CVT-21		
55-4017	CVT-21		
55-4018	CVT-21		
55-4019	CVT-43		
55-4020	CVT-43		
55-4021	CVT-43		
55-4022	CVT-43		
55-4023	CVT-43		
55-4026	CVT-22		
55-4029	CVT-22		
55-4030	CVT-22		
55-4031	CVT-22		
55-4033	CVT-22		
55-4038	CVT-20		
55-4039	CVT-20		
55-4040	CVT-20		
55-4047	CVT-27		
55-4048	CVT-27		
55-4054	CVT-22		
55-4060	CVT-35		
55-4145	CVT-19		
55-4146	CVT-19		
55-4147	CVT-19		
55-4149	CVT-19		
55-4150	CVT-19		
55-4151	CVT-19		
55-4926	CVT-52		
55-4929	CVT-52		
55-4932	CVT-52		
55-5002	CVT-39, PED-6		
55-5004	CVT-39, PED-6		
55-5005	CVT-39, PED-6		
55-5011	CVT-25		
55-5017	CVT-51		
55-5018	CVT-51		
55-5019	CVT-51		
55-5020T	CVT-5		
55-5023	CVT-5		
55-5027T	CVT-48		
55-5028	CVT-48		
55-5030	CVT-48		
55-5033	CVT-49		
55-5035	CVT-13		
55-5037	CVT-47		
55-5038	CVT-13		
55-5040	CVT-36, PED-4		
55-5041	CVT-36		
55-5042	CVT-36, PED-4		
55-5047	CVT-35		
55-5048	CVT-35		
55-5051	CVT-39, PED-5		
55-5052	CVT-39, PED-5		
55-5053	CVT-39, PED-5		
55-5057	CVT-42		
55-5063	CVT-24		
55-5064	CVT-24		
55-5065	CVT-36		
55-5066	CVT-36		
55-5067	CVT-36		
55-5068	CVT-27		
55-5070	CVT-46		
55-5071	CVT-46		
55-5072	CVT-46		
55-5075	CVT-37		
55-5077	CVT-37		
55-5085	CVT-50		
55-5107	CVT-53		
55-5108	CVT-53		
55-5498	CVT-135		
55-5499	CVT-135		
55-5750	RET-34		
55-5751	RET-34		
55-5752	RET-34		
55-5841T	CVT-50		
55-5842T	CVT-50		
55-5843T	CVT-50		
55-5998	CVT-9		
55-6001	CVT-7		
55-6002	CVT-7		
55-6004	CVT-8		
55-6008	CVT-9		
55-6009	CVT-7		
55-6011	CVT-7		
55-6016	CVT-26		
55-6021	CVT-26		
55-6022	CVT-52		
55-6025	CVT-41		
55-6026	CVT-41		
55-6027	CVT-41		
55-6031	CVT-5		
55-6032	CVT-5		
55-6034	CVT-52		
55-6035	CVT-52		
55-6036	CVT-52		
55-6038	CVT-52		
55-6040FC	CVT-34		
55-6042	CVT-52		
55-6044	CVT-45		
55-6047	CVT-45		
55-6050	CVT-50		
55-6055	CVT-10		
55-6057	CVT-11		
55-6059	CVT-3		
55-6060	CVT-3		
55-6061	CVT-4		
55-6062	CVT-4		
55-6064T	CVT-9		

55-6065.....	CVT-11	55-6173.....	CVT-41	55-7060.....	CVT-65
55-6069.....	CVT-53	55-6174.....	CVT-41	55-7105.....	CVT-68
55-6071.....	CVT-53	55-6189.....	CVT-53	55-7110.....	CVT-68
55-6072.....	CVT-31	55-6191.....	CVT-21	55-7115.....	CVT-68
55-6077.....	CVT-53	55-6192.....	CVT-21	55-7120.....	CVT-68
55-6082.....	CVT-21	55-6272.....	CVT-31	55-7125.....	CVT-68
55-6083.....	CVT-226	55-6527.....	GEN-287	55-7130.....	CVT-68
55-6086.....	CVT-226	55-6540.....	CVT-53	55-7200.....	CVT-65
55-6090.....	CVT-41	55-6546.....	CVT-53	55-7205.....	CVT-65
55-6091.....	CVT-41	55-6570.....	CVT-45	55-7210.....	CVT-68
55-6092.....	CVT-41	55-6572.....	CVT-45	55-7215.....	CVT-68
55-6095.....	CVT-43	55-6574.....	CVT-45	55-7220.....	CVT-68
55-6096.....	CVT-43	55-6580.....	CVT-40	55-7220.1.....	CVT-166
55-6097.....	CVT-43	55-6600.....	CVT-18	55-7225.....	CVT-65
55-6098.....	CVT-32	55-6710.....	CVT-226	55-7230.....	CVT-65
55-6099.....	CVT-29	55-6712.....	CVT-226	55-7230.1.....	CVT-166
55-6101.....	CVT-29	55-6714.....	CVT-226	55-7235.....	CVT-65
55-6102.....	CVT-31	55-6716.....	CVT-226	55-7240.....	CVT-65
55-6107.....	CVT-46	55-6925.....	CVT-25	55-7245.....	CVT-65
55-6108.....	CVT-13	55-6926.....	CVT-25	55-7250.....	CVT-65
55-6110.....	CVT-13	55-6927.....	CVT-25	55-7270.....	CVT-65
55-6113.....	CVT-12	55-6928.....	CVT-25	55-7290.....	CVT-65
55-6114.....	CVT-3	55-7001.....	CVT-68	55-7520.....	CVT-30
55-6115.....	CVT-3	55-7002.....	CVT-67	55-7525.....	CVT-29
55-6116.....	CVT-3	55-7003.....	CVT-67	55-7530.....	CVT-30
55-6117.....	CVT-44	55-7004.....	CVT-67	55-7540.....	CVT-29
55-6121.....	CVT-10	55-7005.....	CVT-67	55-7545.....	CVT-29
55-6122.....	CVT-9	55-7006.....	CVT-67	55-7550.....	CVT-29
55-6124.....	CVT-4	55-7007.....	CVT-67	55-7555.....	CVT-30
55-6126.....	CVT-26	55-7008.....	CVT-67	55-8001.....	RET-33
55-6127.....	CVT-26	55-7009.....	CVT-67	55-8002.....	RET-33
55-6128.....	CVT-3	55-7010.....	CVT-67	55-8003.....	RET-33
55-6129.....	CVT-3	55-7011.....	CVT-67	55-8005.....	RET-33
55-6132.....	CVT-39	55-7012.....	CVT-67	55-8008.....	CVT-138, RET-32
55-6133.....	CVT-25	55-7013.....	CVT-67	55-8009.....	RET-32
55-6134.....	CVT-25	55-7014.....	CVT-67	55-8011.....	CVT-187
55-6135.....	CVT-38	55-7015.....	CVT-65, CVT-67	55-8012.....	CVT-200
55-6136.....	CVT-38	55-7016.....	CVT-67	55-8049.....	GEN-289, OPH-52
55-6137.....	CVT-38	55-7017.....	CVT-67	55-8050.....	GEN-289, OPH-52
55-6138.....	CVT-37	55-7018.....	CVT-67	55-8051.....	GEN-289, OPH-52
55-6139.....	CVT-4	55-7019.....	CVT-65, CVT-67	55-8053.....	GEN-289, OPH-52
55-6140.....	CVT-36	55-7020.....	CVT-65, CVT-67	55-8058.....	CVT-214, GEN-305
55-6142.....	CVT-36	55-7026.....	CVT-70, ENT-24, GEN-24, O/A-24	55-8059.....	CVT-214, GEN-305
55-6143.....	CVT-36	55-7027.....	CVT-70, ENT-24, GEN-24, O/A-24	55-8059FL.....	CVT-201
55-6145.....	CVT-12	55-7028.....	CVT-24	55-8060.....	GEN-305
55-6148.....	CVT-22	55-7029.....	CVT-24	55-8061.....	CVT-214, GEN-305
55-6149.....	CVT-21	55-7033.....	CVT-24	55-8062.....	CVT-214, GEN-305
55-6149L.....	CVT-21	55-7034.....	CVT-77	55-8071.....	CVT-191
55-6149R.....	CVT-21	55-7035.....	CVT-77	55-8072.....	CVT-191
55-6152.....	CVT-40	55-7041.....	CVT-68	55-8085.....	CVT-190
55-6155.....	CVT-38	55-7042.....	CVT-68	55-8088.....	CVT-194, GEN-288
55-6161.....	CVT-51	55-7050.....	CVT-24	55-8089.....	GEN-288
55-6162.....	CVT-51	55-7051.....	CVT-24	55-8091.....	CVT-214, GEN-305
55-6170.....	CVT-41	55-7056.....	CVT-218	55-8092.....	CVT-214, GEN-305
55-6171.....	CVT-41			55-8094.....	CVT-214, GEN-305
55-6172.....	CVT-41			55-8095.....	CVT-214, GEN-305

- 55-8160 CVT-214, GEN-305
55-8165 CVT-214, GEN-305
55-8170 CVT-214, GEN-305
55-8175 GEN-305
55-8178 CVT-214, GEN-305
55-8501 CVT-191, GEN-253
55-8502 CVT-191, GEN-253
55-8503 CVT-191, GEN-253
55-8504 CVT-191, GEN-253
55-8505 CVT-191, GEN-253
55-8601 CVT-191, GEN-253
55-8602 CVT-191, GEN-253
55-8603 CVT-191, GEN-253
55-8604 CVT-191, GEN-253
55-8605 CVT-191, GEN-253
55-8680 CVT-227
55-8681 CVT-227
55-8682 CVT-227
55-8683 CVT-227
55-8685 CVT-227
55-8690 CVT-17
55-8700 CVT-200
55-8705 CVT-200, GEN-287
55-8710 CVT-201, GEN-288
55-8711 CVT-201, GEN-288
55-8712 CVT-201, GEN-288
55-8814 CVT-207
55-8910 CVT-95
55-8915 CVT-95
55-8997 CVT-167, RET-63
55-8998 CVT-167, RET-63
55-8999 CVT-172, RET-36
55-8999-1 CVT-172, RET-36
55-8999-2 CVT-172, RET-36
55-8999-3 CVT-172, RET-36
55-8999-4 CVT-172, RET-36
55-8999-5 CVT-172, RET-36
55-8999-6 CVT-172, RET-36
55-8999-7 CVT-172, RET-36
55-8999-8 CVT-172, RET-36
55-8999A RET-36
55-9000 CVT-106, GEN-93
55-9000T CVT-107
55-9001 CVT-106, GEN-93
55-9002T CVT-105
55-9004 CVT-106, GEN-93
55-9005 CVT-106
55-9006 CVT-106, GEN-93,
OBE-32
55-9012 CVT-106
55-9013 CVT-106
55-9016 CVT-116
55-9017 CVT-106
55-9017T CVT-106
55-9019 CVT-91
55-9020 CVT-110
55-9026 CVT-110
55-9028 CVT-110
55-9034 CVT-110
55-9035 CVT-107
55-9035T CVT-107
55-9036 CVT-107
55-9036T CVT-96
55-9037 CVT-107
55-9038 CVT-107
55-9039 CVT-107
55-9040 CVT-118
55-9041 CVT-96
55-9042 CVT-96
55-9043 CVT-106
55-9044 CVT-106
55-9045 CVT-107
55-9045T CVT-107
55-9046 CVT-107
55-9046T CVT-107
55-9048 CVT-106, GEN-94
55-9049 CVT-106
55-9050 CVT-164, RET-36
55-9050B CVT-164
55-9051 CVT-164, RET-36
55-9052 RET-36
55-9053 RET-36
55-9054 RET-36
55-9055 CVT-96
55-9055T CVT-92
55-9056 CVT-96
55-9057 CVT-96
55-9058 CVT-109
55-9059 CVT-109
55-9060 CVT-109
55-9060T CVT-92
55-9061 CVT-109
55-9062 CVT-109
55-9062T CVT-92
55-9065 CVT-109
55-9066T CVT-92
55-9067 CVT-92
55-9067T CVT-92
55-9068 CVT-92
55-9068T CVT-92
55-9069 CVT-92
55-9071 CVT-92
55-9072 CVT-121
55-9073 CVT-121
55-9074 CVT-178, RET-158
55-9075 CVT-178, RET-158
55-9082 CVT-109
55-9083 CVT-109
55-9086 CVT-109
55-9086T CVT-92
55-9088 CVT-91
55-9089 CVT-200
55-9090 CVT-208
55-9092 CVT-105
55-9210 CVT-218
55-9215 CVT-122
55-9221 CVT-94
55-9223 CVT-94
55-9510 CVT-23
55-9511 CVT-23
56-1001-BD .. NEU-97, SPN-165
56-1002-BD .. NEU-97, SPN-165
56-1003-BD .. NEU-97, SPN-165
56-1004-BD .. NEU-97, SPN-165
56-1005 SPN-43, SPN-72,
SPN-107
56-1005-BD .. NEU-97, SPN-165
56-1006 SPN-43, SPN-72,
SPN-107
56-1007 SPN-43, SPN-72,
SPN-107
56-1008 SPN-43, SPN-72,
SPN-107
56-1032 NEU-97
56-1033 NEU-97
56-1201-BD .. NEU-88, SPN-165
56-1202-BD .. NEU-88, SPN-165
56-1203-BD .. NEU-88, SPN-165
56-1204-BD .. NEU-88, SPN-165
56-1205-BD .. NEU-88, SPN-165
56-1506 SPN-172
56-2112-BD ... NEU-91, SPN-178
56-2114-BD ... NEU-91, SPN-178
56-2116-BD ... NEU-91, SPN-178
56-2507 GEN-329, SPN-193
56-2510 CVT-227, SPN-194
56-8040 CVT-188, OBE-70
56-8044 CVT-217, OBE-78
56-8051 CVT-217, OBE-78
56-8055 CVT-216, OBE-77,
OBE-78
56-8056 CVT-216, OBE-77,
OBE-78
57-0001 NEU-125
57-0002 NEU-125
57-0002S NEU-125
57-0003 NEU-125
57-0004 NEU-125
57-0022 NEU-99, SPN-165
57-0022-BD .. NEU-88, SPN-157
57-0022UC... NEU-99, SPN-169
57-0023 NEU-99, SPN-165
57-0023-BD .. NEU-88, SPN-157
57-0023UC SPN-169
57-0024 NEU-99, SPN-165
57-0024-BD .. NEU-88, SPN-157
57-0024UC... NEU-99, SPN-169
57-0025 NEU-99, SPN-165

57-0025-BD ..NEU-88, SPN-157
 57-0025UC.....SPN-169
 57-0070NEU-52
 57-0080.....SPN-129
 57-0101 NEU-100, SPN-166
 57-0102..... NEU-100, SPN-166
 57-0103..... NEU-100, SPN-166
 57-0104..... NEU-100, SPN-166
 57-0105..... NEU-100, SPN-166
 57-0112 SPN-167
 57-0113 SPN-167
 57-0114 SPN-167
 57-0115 SPN-167
 57-0203 NEU-103
 57-0392 NEU-98, SPN-163
 57-0392-BD.. NEU-90, SPN-155
 57-0393 NEU-98, SPN-163
 57-0393-BD . NEU-90, SPN-155
 57-0394 NEU-98, SPN-163
 57-0394-BD . NEU-90, SPN-155
 57-0395 NEU-98, SPN-163
 57-0395-BD . NEU-90, SPN-155
 57-0396SPN-163
 57-0533 NEU-103
 57-0534 NEU-103
 57-0535 NEU-103
 57-0536 NEU-103
 57-0543 NEU-103
 57-0544 NEU-103
 57-0545 NEU-103
 57-0552 NEU-103
 57-0553 NEU-103
 57-0554 NEU-103
 57-0556 NEU-103
 57-0562 NEU-103, SPN-184
 57-0563 NEU-103, SPN-184
 57-0564SPN-184
 57-0565 NEU-103, SPN-184
 57-0572SPN-184
 57-0573SPN-184
 57-0574SPN-184
 57-0575SPN-184
 57-0582 NEU-103, SPN-183
 57-0582-BD... NEU-91, SPN-156
 57-0582UC.. NEU-103, SPN-182
 57-0583 NEU-103, SPN-183
 57-0583-BD .. NEU-91, SPN-156
 57-0583UC.. NEU-103, SPN-182
 57-0584 NEU-103, SPN-183
 57-0584-BD .. NEU-91, SPN-156
 57-0584UC.. NEU-103, SPN-182
 57-0585 NEU-103, SPN-183
 57-0585-BD .. NEU-91, SPN-156
 57-0585UC.. NEU-103, SPN-182
 57-0586 NEU-103, SPN-183
 57-0592SPN-184

57-0593SPN-184
 57-0594SPN-184
 57-0595SPN-184
 57-0602SPN-182
 57-0603 NEU-100, SPN-182
 57-0604 NEU-100, SPN-182
 57-0605 NEU-100, SPN-182
 57-0692 NEU-98, SPN-164
 57-0692-BD . NEU-90, SPN-156
 57-0693 NEU-98, SPN-164
 57-0693-BD . NEU-90, SPN-156
 57-0694 NEU-98, SPN-164
 57-0694-BD . NEU-90, SPN-156
 57-0695 NEU-98, SPN-164
 57-0695-BD . NEU-90, SPN-156
 57-0696 NEU-98, SPN-164
 57-0696-BD . NEU-90, SPN-156
 57-0701..... NEU-100, SPN-165
 57-0701-BD.. NEU-89, SPN-158
 57-0702 NEU-100, SPN-165
 57-0702-BD.. NEU-89, SPN-158
 57-0703 NEU-100, SPN-165
 57-0703-BD . NEU-89, SPN-158
 57-0704 NEU-100, SPN-165
 57-0704-BD . NEU-89, SPN-158
 57-0705 NEU-100, SPN-165
 57-0705-BD . NEU-89, SPN-158
 57-0712..... NEU-100
 57-0713..... NEU-101
 57-0714..... NEU-101
 57-0721..... NEU-100
 57-0721-BD .. NEU-89, SPN-156
 57-0722 NEU-100
 57-0722-BD.. NEU-89, SPN-156
 57-0723 NEU-100
 57-0723-BD.. NEU-89, SPN-156
 57-0724 NEU-100
 57-0724-BD.. NEU-89, SPN-156
 57-0725 NEU-100
 57-0725-BD.. NEU-89, SPN-156
 57-0726-BD.. NEU-89, SPN-156
 57-0739 NEU-100, SPN-168
 57-0739-BD . NEU-89, SPN-158
 57-0740SPN-168
 57-0740-BD . NEU-89, SPN-158
 57-0743 NEU-100, SPN-168
 57-0743-BD.. NEU-89, SPN-158
 57-0744 NEU-100, SPN-168
 57-0744-BD . NEU-89, SPN-158
 57-0745..... NEU-100, SPN-168
 57-0746 NEU-100, SPN-168
 57-0750 NEU-101, SPN-167
 57-0750-BD . NEU-90, SPN-158
 57-0751..... SPN-167
 57-0751-BD .. NEU-90, SPN-158
 57-0752..... NEU-101

57-0752-BD.. NEU-90, SPN-158
 57-0753 SPN-167
 57-0754 NEU-101, SPN-167
 57-0754-BD . NEU-90, SPN-158
 57-0755 NEU-101, SPN-167
 57-0755-BD.....SPN-158
 57-0756 NEU-101, SPN-167
 57-0761..... NEU-100, SPN-166
 57-0761-BD ...NEU-89, SPN-157
 57-0761UC ... NEU-101, SPN-168
 57-0761.5.....SPN-166
 57-0762 NEU-100, SPN-166
 57-0762-BD...NEU-89, SPN-157
 57-0762UC ... NEU-101, SPN-168
 57-0762.15.....SPN-166
 57-0763 NEU-100, SPN-166
 57-0763-BD...NEU-89, SPN-157
 57-0763UC... NEU-101, SPN-168
 57-0763.15 ... NEU-99, SPN-166
 57-0764 NEU-100, SPN-166
 57-0764-BD ..NEU-89, SPN-157
 57-0764UC... NEU-101, SPN-168
 57-0764.15 ... NEU-99, SPN-166
 57-0765 NEU-100, SPN-166
 57-0765-BD...NEU-89, SPN-157
 57-0765UC... NEU-101, SPN-168
 57-0765.15... NEU-99, SPN-166
 57-0766 NEU-100, SPN-166
 57-0766-BD ..NEU-89, SPN-157
 57-0782 NEU-103, SPN-183
 57-0783 NEU-103, SPN-183
 57-0784 NEU-103, SPN-183
 57-0785 NEU-103, SPN-183
 57-0786 NEU-103, SPN-183
 57-0801-BD.. NEU-90, SPN-155
 57-0802-BD . NEU-90, SPN-155
 57-0803-BD . NEU-90, SPN-155
 57-0804-BD . NEU-90, SPN-155
 57-0805-BD SPN-155
 57-0852 NEU-98, SPN-164
 57-0853 NEU-98, SPN-164
 57-0854 NEU-98, SPN-164
 57-0855 NEU-98, SPN-164
 57-0882SPN-183
 57-0883 SPN-183
 57-0884SPN-183
 57-0885SPN-183
 57-0886SPN-183
 57-0891..... NEU-100, SPN-166
 57-0891-BD...NEU-89, SPN-157
 57-0891UCSPN-168
 57-0892 NEU-100, SPN-166
 57-0892-BD ..NEU-89, SPN-157
 57-0892UC... NEU-101, SPN-168
 57-0893 NEU-100, SPN-166
 57-0893-BD ..NEU-89, SPN-157

57-0893UC... NEU-101, SPN-168
 57-0894 NEU-100, SPN-166
 57-0894-BD .. NEU-89, SPN-157
 57-0894UC... NEU-101, SPN-168
 57-0895 NEU-100, SPN-166
 57-0895-BD .. NEU-89, SPN-157
 57-0895UC... NEU-101, SPN-168
 57-0896 NEU-100, SPN-166
 57-0896-BD .. NEU-89, SPN-157
 57-0901 NEU-100, SPN-167
 57-0902 NEU-100, SPN-167
 57-0903 NEU-100, SPN-167
 57-0904 SPN-167
 57-0905 NEU-100, SPN-167
 57-0911 SPN-168
 57-0912 SPN-168
 57-0913 SPN-168
 57-0914 SPN-168
 57-0915 SPN-168
 57-0991 SPN-167
 57-0991UC SPN-169
 57-0992 SPN-167
 57-0992UC SPN-169
 57-0993 SPN-167
 57-0993UC SPN-169
 57-0994 SPN-167
 57-0994UC SPN-169
 57-0995 SPN-167
 57-0995UC SPN-169
 57-0996 SPN-167
 57-1011 NEU-95, SPN-159
 57-1015 NEU-95
 57-1020 NEU-95, SPN-159
 57-1035 NEU-95
 57-1100 NEU-96, SPN-164
 57-1102 NEU-96, SPN-164
 57-1104 NEU-96, SPN-164
 57-1105 NEU-96, SPN-164
 57-1219 NEU-96
 57-1220 NEU-96
 57-1230 NEU-96
 57-1240 NEU-96
 57-1255 NEU-102
 57-1260 NEU-96
 57-1262 NEU-102
 57-1290 SPN-145
 57-1320 NEU-95, SPN-147
 57-1330 NEU-95
 57-1340 NEU-95, SPN-147
 57-1420 NEU-95, SPN-147
 57-1430 NEU-95
 57-1440 NEU-95
 57-1470 SPN-159
 57-1472 SPN-159
 57-1544 NEU-95
 57-1740 NEU-100

57-1997 NEU-94, SPN-144
 57-1998 NEU-94, SPN-144
 57-1999 NEU-94, SPN-144
 57-2000 NEU-94, SPN-144
 57-2001 NEU-94, SPN-144
 57-2002 NEU-94
 57-2012 NEU-94, SPN-145
 57-2013 NEU-97, SPN-150
 57-2014 NEU-97
 57-2022 NEU-94, SPN-145
 57-2023 SPN-145
 57-2032 NEU-94
 57-2033 SPN-146
 57-2036 SPN-145
 57-2040 SPN-149
 57-2042 NEU-94, SPN-146
 57-2043 SPN-149
 57-2052 NEU-94, SPN-146
 57-2060 NEU-94, SPN-145
 57-2062 NEU-94
 57-2063 NEU-94, SPN-146
 57-2065 NEU-94, SPN-146
 57-2066 NEU-97, SPN-149
 57-2070 NEU-97, SPN-149
 57-2073 NEU-97, SPN-149
 57-2075 NEU-97, SPN-150
 57-2076 SPN-149
 57-2082 NEU-94, SPN-146
 57-2090 NEU-101
 57-2091 NEU-104, SPN-152
 57-2092 NEU-101, SPN-151
 57-2094 NEU-101, SPN-151
 57-2095 NEU-96, SPN-148
 57-2097 NEU-94, SPN-146
 57-2098 NEU-94, SPN-146
 57-2099 NEU-94, SPN-146
 57-2100 NEU-94
 57-2103 NEU-97, SPN-149
 57-2122 NEU-94, SPN-145
 57-2123 NEU-97, SPN-149
 57-2133 NEU-97, SPN-149
 57-2152 NEU-94, SPN-146
 57-2153 NEU-97, SPN-149
 57-2163 NEU-97, SPN-150
 57-2182 NEU-94
 57-2183 NEU-97
 57-2204 NEU-104, SPN-154
 57-2214 NEU-104, SPN-154
 57-2224 NEU-104, SPN-154
 57-2244 NEU-104, SPN-154
 57-2254 NEU-104
 57-2270 NEU-104, SPN-154
 57-2273 NEU-104, SPN-154
 57-2274 NEU-104, SPN-153
 57-2275 NEU-104, SPN-153
 57-2284 NEU-104

57-2293 SPN-154
 57-2296 NEU-101
 57-2297 SPN-154
 57-2300 NEU-102, SPN-153
 57-2301 NEU-102
 57-2302 NEU-102, SPN-153
 57-2330 NEU-95
 57-2331 NEU-95
 57-2332 NEU-95
 57-2432 NEU-102
 57-2433 NEU-102
 57-2434 NEU-102
 57-2435 NEU-102, SPN-151
 57-2450 NEU-96
 57-2456 NEU-93
 57-2461 NEU-104, SPN-152
 57-2473 NEU-104, SPN-155
 57-2477 NEU-104, SPN-155
 57-2493 NEU-104, SPN-155
 57-2516 NEU-114
 57-2520 NEU-118
 57-2610 NEU-116
 57-2720 NEU-116
 57-2812 SPN-146
 57-2851 RET-71, RET-126
 57-2852 RET-71, RET-126
 57-2861 RET-126
 57-2862 RET-71, RET-126
 57-2871 RET-71, RET-126
 57-2872 RET-71, RET-126
 57-2901 NEU-91, SPN-144
 57-2901-11 SPN-144
 57-2901-BD .. NEU-92, SPN-143
 57-2902 NEU-91, SPN-144
 57-2902-11 SPN-144
 57-2903 NEU-91, SPN-144
 57-2903-BD .. NEU-92, SPN-143
 57-2904 NEU-91, SPN-144
 57-2905 NEU-92, SPN-143
 57-2906 NEU-92, SPN-143
 57-2908 NEU-92, SPN-143
 57-2910 NEU-92, SPN-143
 57-2910-11 SPN-143
 57-2912 NEU-91, SPN-144
 57-2913 NEU-91, SPN-144
 57-2915 NEU-91, SPN-144
 57-2919 NEU-92, SPN-143
 57-2920-1 ... NEU-92, SPN-143
 57-2921 NEU-92, SPN-143
 57-2922-BD .. NEU-92, SPN-143
 57-2930-BD .. NEU-92, SPN-143
 57-2946 NEU-92, SPN-143
 57-2951 RET-71, RET-126
 57-2952 RET-71, RET-126
 57-2961 RET-71, RET-126
 57-2962 RET-126

57-2971	RET-71, RET-126	57-4074	GEN-326	57-4966	SPN-21
57-2972	RET-71, RET-126	57-4075	GEN-326	57-4967	SPN-21
57-3017	NEU-123	57-4076	SPN-188	57-4968	SPN-20
57-3020	NEU-123	57-4077	SPN-188	57-4969	SPN-20
57-3501	NEU-121	57-4078	SPN-188	57-4970	SPN-20
57-3510	NEU-122	57-4079	SPN-188	57-4971	SPN-20
57-3512	NEU-26	57-4080	SPN-188	57-4972	SPN-20
57-3515	NEU-27, SPN-58	57-4082	SPN-188	57-4973	SPN-20
57-3516	NEU-122	57-4083	GEN-326	57-4974	SPN-21
57-3517	NEU-27	57-4085	SPN-188	57-4975	SPN-21
57-3519	NEU-125	57-4086	GEN-326	57-4976	SPN-21
57-3572	NEU-28	57-4088	GEN-326	57-4977	SPN-21
57-3573	NEU-28	57-4090	GEN-326	57-4978	SPN-21
57-3601	NEU-12	57-4092	GEN-326	57-4979	SPN-21
57-3604	NEU-12	57-4620	SPN-35	57-4980	SPN-20
57-3651	NEU-16	57-4621	SPN-35	57-4981	SPN-20
57-3652	NEU-16	57-4622	SPN-35	57-4982	SPN-20
57-3653	NEU-16	57-4624	NEU-8	57-4983	SPN-20
57-3654	NEU-16	57-4625	SPN-35	57-4984	SPN-20
57-3800	NEU-43	57-4703	SPN-18	57-4985	SPN-20
57-3801	NEU-62	57-4713	SPN-18	57-4999	NEU-47
57-3803	SPN-86	57-4800	SPN-34	57-5000	NEU-47
57-3807	SPN-86	57-4801	SPN-34	57-5001	NEU-47
57-3813	SPN-86	57-4802	SPN-34	57-5002	NEU-47
57-3814	SPN-86	57-4803	NEU-10	57-5003	NEU-47
57-3815	SPN-86	57-4805	NEU-10	57-5005	NEU-50
57-3816	SPN-86	57-4813	NEU-10	57-5008	NEU-46
57-3817	SPN-86	57-4815	NEU-10	57-5009	NEU-46
57-3845	NEU-55	57-4823	NEU-10	57-5010	NEU-46
57-3851	NEU-54	57-4825	NEU-10	57-5011	NEU-46
57-3902	NEU-2	57-4833	NEU-10	57-5031	SPN-170
57-3904	NEU-2	57-4835	NEU-10	57-5032	SPN-170
57-3910	GEN-318	57-4901	SPN-14	57-5038	NEU-23, O/A-21, SPN-56
57-3911	GEN-318	57-4902	SPN-14	57-5039	O/A-21
57-3912	GEN-318	57-4907	SPN-14	57-5045	NEU-50
57-3914	GEN-318	57-4908	SPN-14	57-5100	SPN-95
57-3916	GEN-318	57-4914	SPN-15	57-5101	SPN-43
57-3930	GEN-318	57-4919	SPN-14	57-5105	SPN-43
57-3932	GEN-318	57-4932	SPN-15	57-5106	SPN-95
57-3934	GEN-318	57-4936	SPN-15	57-5106T	SPN-185
57-3953	GEN-3	57-4950	SPN-20	57-5107	SPN-95
57-4044	GEN-327	57-4951	SPN-20	57-5107T	SPN-185
57-4045	GEN-327	57-4952	SPN-20	57-5108	SPN-42
57-4046	GEN-327	57-4953	SPN-20	57-5108T	SPN-185
57-4047	GEN-327	57-4954	SPN-20	57-5109	SPN-47
57-4049	GEN-327	57-4955	SPN-20	57-5111	SPN-46
57-4063	GEN-326	57-4956	SPN-21	57-5115	SPN-42
57-4064	GEN-326	57-4957	SPN-21	57-5116	SPN-42
57-4065	GEN-326	57-4958	SPN-21	57-5205	RET-117, SPN-116
57-4066	GEN-326	57-4959	SPN-21	57-5243	SPN-71
57-4067	GEN-326	57-4960	SPN-21	57-5244	SPN-71
57-4068	GEN-326	57-4961	SPN-21	57-5246	SPN-71
57-4069	GEN-326	57-4962	SPN-21	57-5248	SPN-71
57-4070	GEN-326	57-4963	SPN-21	57-5250	RET-53
57-4072	GEN-326	57-4964	SPN-21	57-5253	NEU-77, RET-53
57-4073	GEN-326	57-4965	SPN-21		

57-5792..... RET-131, SPN-127	57-9028 NEU-77, RET-77	58-0065.....RET-21
57-5793..... RET-129, SPN-125	57-9030 NEU-77, RET-77	58-0073.....CVT-158, GEN-206, RET-29
57-5794 RET-129, SPN-125	57-9032 NEU-77, RET-77	58-0084.....RET-102
57-5795..... RET-129, SPN-125	57-9034 NEU-77, RET-77	58-0084LRET-102
57-5796 RET-129, SPN-125	57-9036 NEU-77, RET-77	58-0093X CVT-154, RET-26
57-5821..... NEU-53	57-9038 NEU-77, RET-77	58-0100CVT-159
57-5890.....RET-120	58-0001.....RET-21	58-0101TRET-28
57-5891.....RET-120	58-0003.....RET-21	58-0102RET-28
57-5901..... NEU-78, RET-84	58-0005.....RET-21	58-0102TRET-28
57-5902 NEU-78, RET-84	58-0009 CVT-157, GEN-205, RET-21, RET-29	58-0103RET-21, RET-28
57-5910..... NEU-78, RET-84	58-0016A.....RET-29	58-0103TRET-28
57-5921..... NEU-79, RET-84	58-0016T.... CVT-157, GEN-205, RET-29	58-0104RET-28
57-5922..... NEU-79, RET-84	58-0017T CVT-157, GEN-205, RET-29	58-0104TRET-28
57-5930 NEU-79, RET-84	58-0018A.....RET-29	58-0106RET-30
57-5941..... NEU-78, RET-84	58-0020.... CVT-156, GEN-204	58-0145 PED-26. RET-21
57-5942 NEU-79, RET-84	58-0021 CVT-156, GEN-204	58-1108-BDSPN-158
57-5943 NEU-79, RET-84	58-0022....CVT-158, GEN-206, RET-30	58-1180SPN-169
57-5960SPN-109	58-0025..... CVT-157, GEN-205, RET-29	58-1200SPN-162
57-6000.....NEU-18	58-0027.....RET-21	58-1200-BD.....SPN-179
57-6004.....NEU-18	58-0029.....RET-21	58-1230.....SPN-179
57-6050.....NEU-2	58-0032ARET-29	58-1230-BD.....SPN-159
57-6111.....NEU-63	58-0035..... CVT-157, GEN-204, RET-28	58-1515 GEN-142
57-6305 NEU-137, SPN-192	58-0036..... CVT-157, GEN-205, RET-21, RET-29	58-1524 NEU-119
57-6313 NEU-137, SPN-192	58-0037..... CVT-157, GEN-204, RET-28	58-1525 NEU-119
57-6402NEU-111	58-0040RET-21	58-1532..... GEN-32
57-6405NEU-52	58-0041RET-21	58-1533..... GEN-32
57-6406NEU-111	58-0042..... GEN-206, RET-21, RET-30	58-1544.....GEN-33, NEU-29
57-6407NEU-110	58-0043.....CVT-158	58-1546.....GEN-33, NEU-29
57-6407LNEU-111	58-0044.....RET-21	58-1547.....GEN-32, NEU-29
57-6408NEU-52	58-0044N...CVT-159, GEN-206, RET-30	58-1548.....GEN-32, NEU-29
57-6430NEU-112	58-0044T ...CVT-158, GEN-206, RET-29	58-1550..... GEN-34, NEU-29
57-6450NEU-112	58-0045.....CVT-158, GEN-206, RET-30	58-1566..... GEN-65, NEU-35
57-6460NEU-112	58-0048T GEN-205, RET-29	58-1920..... NEU-113
57-6470NEU-112	58-0049.....CVT-158, GEN-206, RET-30	58-1921 NEU-113
57-6701.....NEU-123	58-0051T GEN-205, RET-29	58-1929..... NEU-113
57-6702NEU-123	58-0054.....CVT-158, GEN-206, RET-30	58-1931 NEU-113
57-6804NEU-122	58-0056.....CVT-158, GEN-206, RET-30	58-2108B NEU-115
57-6804T.....NEU-122	58-0057N ...CVT-159, GEN-206, RET-30	58-2109B NEU-115
57-6806NEU-122	58-0058SRET-21	58-2180SPN-169
57-7729.....NEU-61	58-0062.....RET-21	58-2180-BD.....SPN-158
57-7730.....NEU-61		58-2200SPN-162
57-7731NEU-61		58-2200-BDSPN-179
57-7732.....NEU-61		58-2230SPN-179
57-7733.....NEU-61		58-2230-BDSPN-159
57-7734.....NEU-61		58-2262SPN-163
57-7735.....NEU-61		58-2262-BD.....SPN-159
57-7736.....NEU-61		58-2263SPN-163
57-7858.....NEU-129		58-2263-BDSPN-159
57-8505NEU-3		58-2264SPN-163
57-9000.....NEU-77, RET-77		58-2264-BDSPN-159
57-9006.....RET-133		58-2265SPN-163
57-9008.....RET-133		58-2265-BDSPN-159
57-9010.....RET-133		58-3015..... NEU-13
57-9022 NEU-77, RET-77		58-3020 NEU-62
57-9024 NEU-77, RET-77		58-3022 NEU-62
57-9026 NEU-77, RET-77		

- 58-3055 NEU-64
58-3062 NEU-56
58-3063 NEU-56
58-3065 NEU-56
58-3180 SPN-169
58-3180J SPN-169
58-3200 SPN-162
58-3200-BD SPN-179
58-3200J SPN-163
58-3200J-BD SPN-179
58-3230 SPN-179
58-3230-BD SPN-159
58-3230J SPN-180
58-3230J-BD SPN-180
58-3305 NEU-55
58-3309 NEU-9
58-3323 NEU-13
58-3325 NEU-13
58-3327 NEU-13
58-3548 NEU-9
58-3550 NEU-9
58-3626 NEU-121
58-3627 NEU-9
58-4180 SPN-169
58-4180J SPN-169
58-4200 SPN-162
58-4200-BD SPN-179
58-4200J SPN-163
58-4200J-BD SPN-179
58-4230 SPN-179
58-4230J SPN-180
58-4230J-BD SPN-180
58-4320-BD SPN-159
58-4475 SPN-94
58-4501 RET-21
58-4502 RET-21
58-4602 NEU-35
58-4610 NEU-35
58-4630 ENT-49
58-4645 NEU-40
58-4652 NEU-40
58-4654 NEU-40
58-4656 NEU-40
58-4751 NEU-37
58-5009 NEU-2
58-5019 NEU-2
58-5029 NEU-2
58-5039 NEU-2
58-5048 NEU-41
58-5078 NEU-2
58-5166 SPN-87
58-5170 SPN-87
58-5180 SPN-169
58-5180J SPN-169
58-5200 SPN-162
58-5200-BD SPN-179
58-5200J SPN-163
58-5200J-BD SPN-179
58-5230 SPN-179
58-5230J SPN-180
58-5230J-BD SPN-180
58-5320-BD SPN-159
58-5450T NEU-113
58-5451T NEU-113
58-5454T NEU-113
58-5669 OBGYN-45
58-5938T NEU-57
58-6010T NEU-27
58-6011 NEU-22
58-6020T NEU-17
58-6021T NEU-17
58-6022T NEU-17
58-6030T NEU-53
58-6031 NEU-53
58-6032T NEU-53
58-6063T NEU-48
58-6065T NEU-48
58-6201 NEU-54
58-6202 NEU-54
58-6203 NEU-21
58-6204 NEU-21
58-6206 NEU-15
58-6208 NEU-63
58-6209A NEU-52
58-6212 NEU-62
58-6214 NEU-13
58-6260 NEU-15
58-6303 GEN-324, NEU-129
58-6305 GEN-324, NEU-129
58-6307 GEN-324, NEU-129
58-6310 GEN-324, NEU-129
58-6311 GEN-324, NEU-129
58-6313 GEN-324, NEU-129
58-6315 GEN-324, NEU-129
58-6317 GEN-324, NEU-129
58-6320 GEN-324, NEU-129
58-6322 GEN-324, NEU-129
58-6327 GEN-324, NEU-129
58-6330 GEN-324, NEU-129
58-6331 GEN-324, NEU-129
58-6335 GEN-324, NEU-129
58-6337 GEN-324, NEU-129
58-6340 GEN-324, NEU-129
58-7558 NEU-28
58-7560 NEU-28
58-7576 NEU-53
59-0000 RET-138, RET-139,
RET-140, SPN-101, SPN-102,
SPN-103
59-0017 SPN-103
59-0022 SPN-108
59-0030 RET-138, SPN-101,
SPN-108
59-0031 RET-138, SPN-101,
SPN-108
59-0032 RET-138, SPN-101,
SPN-108
59-0033 RET-138, SPN-101
59-0034 RET-138, SPN-101,
SPN-108
59-0035 RET-138, SPN-101
59-0036 RET-138, SPN-101,
SPN-108
59-0037 RET-138, SPN-101,
SPN-108
59-0038 RET-138, SPN-101,
SPN-108
59-0039 RET-138, SPN-101,
SPN-108
59-0041 SPN-108
59-0050 RET-139, SPN-102
59-0051 RET-139, SPN-102
59-0052 RET-139, SPN-102
59-0053 RET-139, SPN-102
59-0054 RET-139, SPN-102
59-0055 RET-139, SPN-102,
SPN-108
59-0056 RET-139, SPN-102
59-0057 RET-139, SPN-102
59-0070 RET-139, SPN-102
59-0071 RET-139, SPN-102,
SPN-108
59-0072 RET-139, SPN-102
59-0073 RET-139, SPN-102
59-0074 RET-139, SPN-102,
SPN-108
59-0075 RET-139, SPN-102,
SPN-108
59-0076 RET-139, SPN-102
59-0077 RET-139, SPN-102
59-0080 RET-138, SPN-101
59-0081 RET-138, SPN-101,
SPN-129
59-0082 RET-138, SPN-101
59-0083 RET-138, SPN-101
59-0084 RET-138, SPN-101
59-0085 RET-138, SPN-101
59-0090 RET-138, SPN-101
59-0091 RET-138, SPN-101
59-0092 RET-138, SPN-101
59-0093 RET-138, SPN-101
59-0094 RET-138, SPN-101
59-0095 RET-138, SPN-101
59-0100
CVT-160, GEN-207, RET-74,
RET-139, SPN-100, SPN-102
59-0101
CVT-160, GEN-207, RET-74,

RET-139, SPN-100, SPN-102	59-1061 RET-143, SPN-106	59-2015 RET-141, SPN-104
59-0105 CVT-156, GEN-203, RET-138, SPN-101, SPN-111	59-1070 GEN-310, NEU-125, RET-143, SPN-106	59-2016 RET-141, SPN-104
59-0106 RET-138, SPN-62, SPN-101	59-1071 GEN-310, NEU-125, RET-143, SPN-106	59-2017 RET-141, SPN-104
59-0109 RET-139, SPN-45, SPN-102	59-1072 RET-143, SPN-106	59-2018 RET-141, SPN-104
59-0110 RET-140, SPN-103	59-1073 RET-143, SPN-106	59-2019 RET-141, SPN-104
59-0111 RET-140, SPN-103	59-1080 GEN-309, NEU-124, RET-142, SPN-105	59-2020 RET-141, SPN-104
59-0112 SPN-45	59-1081 GEN-309, NEU-124, RET-142, SPN-105	59-2021 RET-141, SPN-104
59-0113 RET-139, SPN-102	59-1082 GEN-309, NEU-124, RET-142, SPN-105	59-2023 RET-141, SPN-104
59-0115 RET-140, SPN-103	59-1083 GEN-309, NEU-124, RET-142, SPN-105	59-2024 RET-141, SPN-104
59-0116 RET-140, SPN-103	59-1084 GEN-309, NEU-124, RET-142, SPN-105	59-2025 RET-141, SPN-104
59-0117 RET-140, SPN-103	59-1085 GEN-309, NEU-124, RET-142, SPN-105	59-2026 RET-141, SPN-104
59-0118 RET-140, SPN-103	59-1086 GEN-309, NEU-124, RET-142, SPN-105	59-2027 RET-141, SPN-104
59-0120 RET-140, SPN-2, SPN-103	59-1087 GEN-309, NEU-124, RET-142, SPN-105	59-2028 RET-141, SPN-104
59-0121 RET-140, SPN-103, SPN-190	59-1100 RET-142, SPN-105	59-2029 RET-141, SPN-104
59-0122 RET-140, SPN-103, SPN-190	59-1101 RET-142, SPN-105	59-2031 NEU-116
59-0123 RET-140, SPN-103, SPN-190	59-1102 RET-142, SPN-105	59-2033 NEU-116
59-0124 RET-140, SPN-58, SPN-103	59-1103 RET-142, SPN-105	59-2034 NEU-116
59-0131 RET-140, SPN-66, SPN-103	59-1104 RET-142, SPN-105, SPN-122	59-2035 RET-141, SPN-104
59-0600 SPN-101	59-1105 RET-142, SPN-105	59-2036 RET-141, SPN-104
59-1000 NEU-27, OBE-78, SPN-58	59-1180 SPN-170	59-2037 RET-141, SPN-104
59-1000S RET-142, SPN-105	59-1180-BD SPN-178	59-2038 RET-141, SPN-104
59-1030 RET-142, SPN-105, SPN-109	59-1200 SPN-162	59-2039 RET-141, SPN-104
59-1031 RET-142, SPN-105, SPN-109	59-1200-BD SPN-179	59-2040 RET-141, SPN-104
59-1032 RET-142, SPN-105, SPN-109	59-1230 SPN-180	59-2180 SPN-170
59-1033 RET-142, SPN-105, SPN-109	59-1230-BD SPN-159	59-2180-BD SPN-178
59-1034 RET-142, SPN-105, SPN-109	59-1620 NEU-116	59-2200 SPN-162
59-1035 RET-142, SPN-105, SPN-109	59-1700 RET-143, SPN-10, SPN-106	59-2200-BD SPN-179
59-1036 RET-142, SPN-105, SPN-109	59-2000 SPN-100	59-2230 SPN-180
59-1037 RET-142, SPN-105, SPN-109	59-2001 RET-141, SPN-104, SPN-108	59-2230-BD SPN-159
59-1050 RET-143, SPN-106	59-2002 RET-141, SPN-104	59-2320 NEU-116
59-1051 RET-143, SPN-106	59-2003 RET-141, SPN-104	59-2321 NEU-116
59-1052 RET-143, SPN-106	59-2004 RET-141, SPN-104	59-2330 NEU-116
59-1053 RET-143, SPN-106	59-2005 RET-141, SPN-104	59-2331 NEU-116
59-1056 RET-143, SPN-106	59-2006 RET-141, SPN-104	59-2336 NEU-116
59-1057 RET-143, SPN-106	59-2007 RET-141, SPN-104	59-2342 NEU-29, NEU-58
59-1058 RET-143, SPN-106	59-2008 RET-141, SPN-104	59-2342M NEU-29
59-1059 RET-143, SPN-106	59-2009 RET-141, SPN-104	59-2345 NEU-58
59-1060 RET-143, SPN-106	59-2010 RET-141, SPN-104, SPN-108	59-2349 NEU-58
	59-2011 RET-141, SPN-104	59-3000 RET-141, SPN-104
	59-2012 RET-141, SPN-104	59-3180 SPN-170
	59-2013 RET-141, SPN-104	59-3180-BD SPN-178
	59-2014 RET-141, SPN-104	59-3180J SPN-162
		59-3200 SPN-162
		59-3200-BD SPN-179
		59-3200J SPN-163
		59-3230-BD SPN-159
		59-3230J SPN-180
		59-3320 SPN-180
		59-4180 SPN-170
		59-4180-BD SPN-178
		59-4180J SPN-162
		59-4200 SPN-162
		59-4200-BD SPN-179
		59-4200J SPN-163
		59-4230 SPN-180
		59-4230-BD SPN-159

59-4230J.....	SPN-180	60-1000.....	NEU-126	60-1201.....	OPH-4
59-4410.....	NEU-33	60-1001.....	NEU-126	60-1203.....	OPH-10
59-4411.....	NEU-33	60-1002.....	NEU-126	60-1211.....	OPH-6
59-5180.....	SPN-170	60-1003.....	NEU-126	60-1216.....	OPH-5
59-5180-BD.....	SPN-178	60-1010.....	NEU-123	60-1225.....	OPH-3
59-5180J.....	SPN-162	60-1013.....	OPH-49	60-1226.....	OPH-3
59-5200.....	SPN-162	60-1018.....	OPH-40	60-1227.....	OPH-5
59-5200-BD.....	SPN-179	60-1045.....	OPH-35	60-1229.....	OPH-3
59-5200J.....	SPN-163	60-1066.....	OPH-67	60-1235.....	OPH-7
59-5230-BD.....	SPN-159	60-1067.....	OPH-67	60-1260.....	OPH-8
59-5230J.....	SPN-180	60-1068.....	OPH-67	60-1275.....	OPH-36
59-5320.....	SPN-180	60-1070.....	OPH-45	60-1278.....	OPH-36
59-5912.....	NEU-58	60-1074.....	OPH-67	60-1280.....	OPH-36
59-5932.....	NEU-116	60-1076.....	OPH-67	60-1281.....	OPH-36
59-7905.....	NEU-74, RET-84	60-1077.....	OPH-67	60-1285.....	OPH-36
59-8801.....	RET-31, RET-158	60-1086.....	OPH-5	60-1295.....	OPH-72
59-8802.....	CVT-184-186, GEN-208-209, RET-31, RET-158	60-1087.....	OPH-7	60-1298.....	ENT-65, GEN-124, OPH-29
59-8803.....	CVT-184-186, GEN-208-209, RET-31, RET-158	60-1090.....	OPH-68	60-1299.....	ENT-65, GEN-124, OPH-29
59-8804.....	CVT-185-186, GEN-209, RET-158	60-1091.....	OPH-68	60-1300.....	OPH-33
59-8805.....	CVT-184-186, GEN-207-209, RET-31, RET-158	60-1092.....	OPH-68	60-1306.....	OPH-31
59-8807.....	CVT-184-186, GEN-208-209, RET-31, RET-158	60-1095.....	OPH-68	60-1307.....	OPH-32
59-8807A...CVT-159, GEN-207		60-1097.....	OPH-68	60-1309.....	OPH-28
59-8808.....	CVT-187, RET-158	60-1099.....	OPH-68	60-1310.....	OPH-32
59-8809.....	CVT-184-186, GEN-208-209, RET-31, RET-158	60-1109.....	OPH-68	60-1310A.....	OPH-32
59-8811.....	CVT-184-186, GEN-208-209, RET-31, RET-158	60-1114.....	OPH-31	60-1311.....	OPH-31
59-8813.....	CVT-184-185, GEN-208-209, RET-31	60-1115.....	OPH-31	60-1314.....	OPH-38
59-8814.....	CVT-184-185, GEN-208,-209, RET-31	60-1116.....	OPH-49	60-1317.....	OPH-37
59-8815.....	CVT-184-186, GEN-208-209, RET-31, RET-158	60-1117.....	OPH-37	60-1319.....	OPH-28
59-8816.....	CVT-185-186, GEN-208-209, RET-31, RET-158	60-1118.....	OPH-27	60-1324.....	OPH-27
59-8816A... CVT-156, GEN-203		60-1119.....	OPH-37	60-1326.....	OPH-29
59-8818.....	CVT-184-186, GEN-208-209, RET-31, RET-158	60-1123.....	OPH-29	60-1327.....	OPH-33
59-8820.....	CVT-185-186, RET-158	60-1125.....	OPH-38	60-1328.....	OPH-28
59-8821.....	CVT-184-186, GEN-208-209, RET-31, RET-158	60-1126.....	OPH-30	60-1333.....	OPH-37
59-8824.....	CVT-185-186, RET-158	60-1127.....	OPH-30	60-1334.....	OPH-30
59-8828.....	CVT-184-186, GEN-208-209, RET-31, RET-158	60-1128.....	OPH-30	60-1339.....	OPH-30
59-8850.....	CVT-184, GEN-208, RET-31	60-1130.....	OPH-6	60-1340.....	OPH-30
59-8855.....	CVT-185, GEN-209	60-1131.....	OPH-6	60-1344.....	OPH-33
59-8860.....	CVT-185	60-1147.....	OPH-5	60-1346.....	OPH-33
59-8865.....	CVT-186, RET-158	60-1148.....	OPH-3	60-1348.....	OPH-33
60-0226.....	OPH-4	60-1149.....	OPH-3	60-1349.....	OPH-31
60-0300.....	ENG-22, ENG-65	60-1150.....	OPH-40	60-1352.....	OPH-24
		60-1151.....	OPH-40	60-1353.....	OPH-24
		60-1154.....	OPH-7	60-1363.....	OPH-32
		60-1156.....	OPH-7	60-1366.....	OPH-32
		60-1157.....	OPH-7	60-1367.....	OPH-32
		60-1158.....	OPH-7	60-1369.....	OPH-38
		60-1159.....	OPH-7	60-1388.....	OPH-46
		60-1179.....	OPH-7	60-1389.....	OPH-46, RET-85
		60-1180.....	OPH-4	60-1390.....	OPH-46, RET-85
		60-1186.....	OPH-3	60-1394.....	OPH-47
		60-1187.....	OPH-3	60-1403.....	OPH-46, RET-86
		60-1188.....	OPH-7	60-1404.....	OPH-46, RET-86
		60-1189.....	OPH-4	60-1405.....	OPH-46, RET-86
		60-1192.....	OPH-3	60-1406.....	OPH-46, RET-86
		60-1193.....	OPH-3		
		60-1198.....	OPH-4		

60-1407.....	OPH-46, RET-86	60-1579.....	OPH-20	60-1714.....	OPH-18
60-1408.....	OPH-47, RET-87	60-1580.....	OPH-20	60-1716.....	OPH-20
60-1412.....	OPH-72	60-1583.....	OPH-15	60-1717.....	OPH-11
60-1413.....	OPH-47, RET-76	60-1590.....	OPH-22	60-1718.....	OPH-15
60-1416.....	RET-76	60-1592.....	OPH-22	60-1727.....	OPH-20
60-1421.....	OPH-8	60-1596.....	OPH-22	60-1730.....	OPH-11
60-1422.....	OPH-8	60-1598.....	OPH-23	60-1732.....	OPH-25
60-1423.....	OPH-8	60-1605.....	OPH-22	60-1736.....	OPH-12
60-1424.....	OPH-8	60-1606.....	OPH-22	60-1739.....	OPH-12
60-1425.....	OPH-8	60-1608.....	GEN-117, OPH-19	60-1749.....	GEN-281, OPH-53
60-1428.....	OPH-8	60-1609.....	GEN-117, OPH-19	60-1750.....	GEN-281, OPH-53
60-1429.....	OPH-8	60-1612.....	OPH-18	60-1751.....	GEN-281, OPH-53
60-1430.....	OPH-8	60-1618.....	OPH-25	60-1752.....	OPH-50
60-1432.....	OPH-8	60-1619.....	OPH-25	60-1753.....	OPH-50
60-1434.....	OPH-40	60-1621.....	GEN-74, OPH-19	60-1754.....	OPH-50
60-1438.....	OPH-73	60-1627.....	GEN-73, OPH-14	60-1755.....	OPH-52
60-1439.....	OPH-73	60-1628.....	GEN-73, OPH-14	60-1756.....	OPH-51
60-1441.....	OPH-73	60-1629.....	GEN-73, OPH-14	60-1759.....	OPH-56
60-1443.....	OPH-73	60-1630.....	GEN-73, OPH-14	60-1760.....	OPH-56
60-1453.....	OPH-17	60-1631.....	GEN-73, OPH-14	60-1762.....	OPH-64
60-1456.....	OPH-17	60-1631T.....	OPH-14	60-1763.....	OPH-64
60-1458.....	OPH-17	60-1632.....	GEN-73, OPH-14	60-1764.....	OPH-64
60-1462.....	OPH-25	60-1632T.....	OPH-14	60-1768.....	OPH-51
60-1463.....	OPH-25	60-1633.....	GEN-108, OPH-23	60-1770.....	OPH-51
60-1465.....	OPH-18	60-1634.....	GEN-73, OPH-14	60-1773.....	OPH-50
60-1467.....	OPH-15	60-1635.....	GEN-74, OPH-14	60-1774.....	OPH-50
60-1470.....	OPH-21	60-1637.....	GEN-73, OPH-14	60-1776.....	OPH-51
60-1471.....	OPH-26	60-1638.....	GEN-74, OPH-14	60-1779.....	OPH-51
60-1490.....	OPH-20	60-1639.....	GEN-74, OPH-14	60-1783.....	OPH-52
60-1492.....	OPH-26	60-1641.....	GEN-73, OPH-13	60-1784.....	OPH-52
60-1492S.....	OPH-26	60-1650.....	GEN-74, OPH-23	60-1786.....	OPH-51
60-1494.....	OPH-21	60-1651.....	OPH-22	60-1787.....	OPH-51
60-1496.....	OPH-17	60-1653.....	OPH-17	60-1792.....	OPH-64
60-1499.....	OPH-26	60-1660.....	OPH-13	60-1793.....	OPH-64
60-1506.....	OPH-13	60-1664.....	OPH-19	60-1796.....	OPH-66
60-1510.....	OPH-17	60-1665.....	OPH-19	60-1797.....	OPH-66
60-1511.....	OPH-17	60-1669.....	OPH-12	60-1799.....	OPH-66
60-1512.....	OPH-13	60-1670.....	OPH-12	60-1800.....	OPH-66
60-1515.....	OPH-18	60-1673.....	OPH-22	60-1803.....	OPH-61
60-1516.....	OPH-18	60-1674.....	OPH-22	60-1804.....	GEN-301, OPH-61
60-1517.....	OPH-18	60-1675.....	OPH-26	60-1805.....	OPH-61
60-1522.....	GEN-83, OPH-12	60-1677.....	OPH-13	60-1806.....	OPH-61
60-1523.....	OPH-12	60-1680.....	OPH-21	60-1807.....	GEN-301, OPH-61
60-1524.....	GEN-83, OPH-12	60-1683.....	OPH-19	60-1808.....	OPH-66
60-1530.....	OPH-17	60-1689.....	OPH-19	60-1810.....	OPH-62
60-1534.....	OPH-21	60-1690.....	GEN-63, OPH-19	60-1812.....	GEN-294, OPH-61
60-1535.....	OPH-21	60-1691.....	OPH-19	60-1813.....	GEN-294, OPH-61
60-1541.....	OPH-16	60-1692.....	GEN-63, OPH-19	60-1814.....	OPH-55
60-1542.....	OPH-16	60-1693.....	GEN-63, OPH-19	60-1815.....	OPH-55
60-1544.....	OPH-24	60-1694.....	GEN-63, OPH-19	60-1816.....	OPH-58
60-1547.....	OPH-14	60-1695.....	OPH-19	60-1817.....	OPH-56
60-1548.....	OPH-14	60-1696.....	OPH-23	60-1821.....	OPH-50
60-1552.....	OPH-20	60-1699.....	OPH-11	60-1822.....	OPH-60
60-1553.....	OPH-21	60-1701.....	OPH-15	60-1823.....	GEN-284, OPH-55
60-1577.....	OPH-23	60-1711.....	OPH-15	60-1824.....	GEN-284, OPH-55
60-1578.....	OPH-11	60-1712.....	OPH-16	60-1825.....	OPH-55

60-1826.....	GEN-284, OPH-55	60-1921.....	OPH-41, OPH-42	60-2010.....	OPH-9
60-1827.....	GEN-284, OPH-55	60-1922.....	OPH-42	60-2011.....	OPH-9
60-1828.....	GEN-284, OPH-55	60-1923.....	OPH-42	60-2012.....	OPH-9
60-1829.....	GEN-284, OPH-55	60-1924.....	OPH-42	60-2014.....	OPH-34
60-1830.....	GEN-284, OPH-55	60-1925.....	OPH-42	60-2026.....	OPH-8
60-1831.....	OPH-50	60-1931.....	OPH-2	60-2027.....	OPH-8
60-1833.....	OPH-65	60-1932.....	OPH-2	60-2100.....	OPH-45
60-1834.....	OPH-65	60-1934.....	OPH-2	60-2110.....	OPH-45
60-1835.....	OPH-65	60-1936.....	OPH-2	60-2111.....	OPH-45
60-1836.....	OPH-65	60-1937.....	OPH-70, RET-86	60-2112.....	OPH-45
60-1839.....	OPH-65	60-1938.....	RET-86	60-2113.....	OPH-45
60-1842.....	OPH-66	60-1941.....	OPH-72, RET-88	60-2114.....	OPH-45
60-1843.....	GEN-284, OPH-56	60-1943.....	OPH-69, RET-86	60-2328.....	OPH-28
60-1844.....	GEN-284, OPH-56	60-1951.....	OPH-70	60-2801.....	OPH-41
60-1845.....	GEN-284, OPH-56	60-1953.....	OPH-71	60-2803.....	OPH-41
60-1846.....	GEN-284, OPH-56	60-1954.....	OPH-71	60-3006.....	OPH-67
60-1847.....	GEN-282, OPH-56	60-1958.....	OPH-70	60-3015.....	OPH-48
60-1848.....	GEN-282, OPH-56	60-1959.....	OPH-70	60-3017.....	OPH-48
60-1850.....	GEN-253, OPH-66	60-1960.....	OPH-70	60-3022.....	OPH-48
60-1852.....	OPH-56	60-1961.....	OPH-72	60-3023.....	OPH-34
60-1853.....	GEN-303, OPH-65	60-1962.....	OPH-69, PED-43	60-4080.....	OPH-2
60-1854.....	OPH-56	60-1963.....	OPH-69	60-4175.....	OPH-2
60-1855.....	OPH-52	60-1964.....	OPH-69	60-4177.....	OPH-2
60-1856.....	OPH-62	60-1966.....	OPH-69	60-4991.....	OPH-29
60-1857.....	OPH-62	60-1967.....	OPH-69	60-5008.....	OPH-47, RET-87
60-1859.....	OPH-65	60-1968.....	OPH-71	60-5149.....	OPH-25
60-1862.....	OPH-53	60-1969.....	OPH-69	60-5150.....	OPH-24
60-1863.....	OPH-53	60-1970.....	OPH-71	60-5315.....	OPH-15
60-1864.....	OPH-53	60-1971.....	OPH-72	60-5325.....	OPH-25
60-1865.....	GEN-287, OPH-57	60-1972.....	OPH-72	60-5326.....	OPH-25
60-1866.....	GEN-287, OPH-57	60-1974.....	OPH-69	60-5340.....	OPH-24
60-1868.....	ENT-133	60-1976.....	OPH-45	60-5342.....	OPH-24
60-1869.....	OPH-60	60-1977.....	OPH-45	60-5400.....	OPH-26
60-1874.....	OPH-42	60-1978.....	OPH-45	60-5502.....	OPH-43
60-1876.....	OPH-44	60-1979.....	OPH-45	60-5503.....	OPH-43
60-1886.....	OPH-41	60-1980.....	OPH-45	60-5504.....	OPH-43
60-1887.....	OPH-41	60-1981.....	OPH-45	60-5505.....	OPH-43
60-1888.....	OPH-41	60-1982.....	OPH-46	60-5509.....	GEN-149, OPH-43
60-1892.....	OPH-43	60-1983.....	OPH-46	60-5510.....	GEN-149, OPH-43
60-1894.....	OPH-43	60-1984.....	OPH-46	60-5511.....	GEN-149, OPH-43
60-1895.....	OPH-43	60-1985.....	OPH-46	60-5520.....	GEN-149, OPH-44
60-1896.....	OPH-41	60-1986.....	OPH-46	60-5524.....	OPH-44
60-1897.....	OPH-41	60-1988.....	OPH-28	60-5526.....	OPH-44
60-1899.....	OPH-44	60-1989.....	OPH-45	60-5530.....	OPH-16
60-1900.....	OPH-44	60-1990.....	OPH-34	60-6009.....	NEU-115
60-1901.....	OPH-44	60-1991.....	OPH-10	60-6030.....	OPH-73
60-1902.....	OPH-44	60-1992.....	OPH-34	60-6031.....	OPH-73
60-1903.....	OPH-41	60-1993.....	OPH-10	60-6715.....	NEU-42
60-1904.....	OPH-41	60-1994.....	OPH-10	60-7000.....	OPH-48
60-1905.....	OPH-41	60-1995.....	OPH-10	60-7000-OL..	ENG-65, ENT-32
60-1909.....	OPH-42	60-1996.....	OPH-10	60-7001.....	OPH-48
60-1910.....	OPH-41, OPH-42	60-2000.....	OPH-9	60-7002.....	OPH-39
60-1917.....	OPH-42	60-2003.....	OPH-71, RET-88	60-7010.....	OPH-39
60-1918.....	OPH-42	60-2004.....	OPH-71, RET-88	60-7014.....	OPH-39
60-1919.....	OPH-42	60-2005.....	OPH-71, RET-88	60-7026.....	OPH-39
60-1920.....	OPH-42	60-2009.....	OPH-9	60-7051.....	OPH-39

60-7052	OPH-39	61-0266	ENT-76	61-0383	ENT-90
60-7065	OPH-48	61-0269	ENT-75	61-0384	ENT-90
60-7086	OPH-27	61-0270	ENT-74	61-0386	ENT-68
60-7100	ENG-64, ENT-31	61-0271	ENT-74	61-0387	ENT-92
60-7200	ENG-65, ENT-32	61-0272	ENT-24	61-0388	ENT-92
60-8036	OPH-39	61-0273	ENT-76	61-0389	ENT-92
60-9155T	OPH-35	61-0301	ENT-23	61-0390	ENT-80
60-9201T	OPH-24	61-0302	ENT-21	61-0391	ENT-89
60-9516T	OPH-33	61-0303	ENT-43	61-0392	ENT-89
61-0015	ENT-12	61-0304	ENT-43	61-0394	ENT-22
61-0016	ENT-12	61-0305	ENT-84	61-0395	ENT-76
61-0024	ENT-65	61-0306	ENT-91	61-0396	ENT-75
61-0108	ENT-47	61-0307	ENT-91	61-0397	ENT-76
61-0111	ENT-47	61-0308	ENT-91	61-0398	ENT-15
61-0113	ENT-49	61-0310	ENT-4	61-0398E	ENT-15
61-0116	ENT-48	61-0311	ENT-5	61-0399	ENT-15
61-0118	ENT-48	61-0317	ENT-91	61-0406	ENT-20
61-0119	ENT-49	61-0319	ENT-43	61-0408	ENT-83
61-0120	ENT-49	61-0321	ENT-43	61-0409	ENT-83
61-0121	ENT-47	61-0323	ENT-22	61-0415	ENT-72
61-0122	ENT-47	61-0327	ENT-14	61-0425	ENT-92
61-0123	ENT-47, ENT-48	61-0328	ENT-14	61-0426	ENT-92
61-0123I	ENT-48	61-0329	ENT-14	61-0429	ENT-101
61-0124	ENT-55	61-0331	ENT-74	61-0430	ENT-101
61-0125	ENT-55	61-0335	ENT-90	61-0431	ENT-83
61-0126	ENT-55	61-0336	ENT-90	61-0435	ENT-75
61-0127	ENT-44	61-0338	ENT-91	61-0440	ENT-23
61-0129	ENT-55	61-0340	ENT-23, ENT-90	61-0445	ENT-92
61-0130	ENT-55	61-0343	ENT-80	61-0446	ENT-92
61-0132	ENT-44	61-0344	ENT-76	61-0450	ENT-16
61-0133	ENT-46	61-0345	ENT-76	61-0451	ENT-16
61-0134	ENT-46	61-0348	ENT-14	61-0469	ENT-77
61-0136	ENT-44	61-0349	ENT-92	61-0470	ENT-76
61-0137	ENT-145	61-0351	ENT-90	61-0471	ENT-76
61-0138	ENT-54	61-0352	ENT-75	61-0473	ENT-66
61-0139	ENT-55	61-0359	ENT-84	61-0474E	ENT-67
61-0140	ENT-55	61-0361	ENT-84	61-0475	ENT-66
61-0142	ENT-54	61-0363	ENT-43	61-0476	ENT-67
61-0143	ENT-54	61-0364	ENT-149	61-0477	ENT-84
61-0145	ENT-46	61-0365	ENT-89	61-0483	ENT-89
61-0146	ENT-55	61-0366	ENT-84	61-0511	ENT-7
61-0147	ENT-54	61-0367	ENT-4	61-0512	ENT-7
61-0147E	ENT-54	61-0368	ENT-4	61-0514	ENT-28
61-0150	ENT-59	61-0369	ENT-4	61-0516	ENT-80
61-0150E	ENT-59	61-0371	ENT-90	61-0517	ENT-93
61-0152	ENT-54	61-0372	ENT-91	61-0518	ENT-93
61-0154	ENT-54	61-0373	ENT-90	61-0519	ENT-93
61-0155	ENT-54	61-0374	ENT-91	61-0594	ENT-77
61-0155E	ENT-54	61-0375	ENT-91	61-0595	ENT-77
61-0157	ENT-85	61-0376	ENT-23	61-0600	ENT-110, RET-91
61-0158	ENT-85	61-0377	ENT-75	61-0601	ENT-110, RET-38
61-0160	ENT-53	61-0378	ENT-75	61-0605	ENT-111, RET-64
61-0160E	ENT-53	61-0379	ENT-77	61-0606	ENT-111, RET-64
61-0170	ENT-54	61-0380	ENT-15	61-0610	ENT-113, PED-29, RET-69
61-0256	ENT-73	61-0381	ENT-15	61-0699	ENT-18
61-0258	ENT-73	61-0382	ENT-15		

61-0700	ENT-85	61-0923	ENT-142	61-0962	ENT-144
61-0704	ENT-123	61-0923E	ENT-142	61-0963	ENT-144
61-0705	ENT-123	61-0924	ENT-143	61-0965	ENT-143
61-0706	ENT-123	61-0924E	ENT-143	61-0966	ENT-143
61-0707	ENT-123	61-0925	ENT-143	61-0967	ENT-143
61-0708	ENT-123	61-0925E	ENT-143	61-0968	ENT-144
61-0708E	ENT-123	61-0926	ENT-143	61-0969	ENT-144
61-0709	ENT-129	61-0926E	ENT-143	61-0970	ENT-144
61-0710	ENT-123	61-0927	ENT-143	61-0971	ENT-144
61-0710E	ENT-123	61-0927E	ENT-143	61-0973	ENT-144
61-0712	ENT-124	61-0928	ENT-143	61-0974	ENT-144
61-0713	ENT-129	61-0928E	ENT-143	61-0975	ENT-144
61-0831	ENT-141	61-0929	ENT-143	61-0979	ENT-143
61-0831E	ENT-141	61-0929E	ENT-143	61-0980	ENT-141
61-0833	ENT-141	61-0930	ENT-143	61-0980E	ENT-141
61-0833E	ENT-141	61-0930E	ENT-143	61-0982	ENT-141
61-0834	ENT-141	61-0931	ENT-141	61-0982E	ENT-141
61-0834E	ENT-141	61-0931E	ENT-141	61-1004	SPN-72, SPN-107, SPN-187
61-0835	ENT-141	61-0931.5	ENT-141	61-1005	SPN-187
61-0835E	ENT-141	61-0931.5E	ENT-141	61-1010	ENT-145
61-0836	ENT-141	61-0932	ENT-141	61-1011	ENT-145
61-0836E	ENT-141	61-0932E	ENT-141	61-1012	ENT-145
61-0901	ENT-143	61-0932.5	ENT-141	61-1013	ENT-145
61-0902	ENT-143	61-0932.5E	ENT-141	61-1014	ENT-145
61-0903	ENT-143	61-0933	ENT-141	61-1015	ENT-145
61-0904	ENT-143	61-0933E	ENT-141	61-1016	ENT-145
61-0906	ENT-143	61-0933.5	ENT-141	61-1021	GEN-317
61-0907	ENT-143	61-0933.5E	ENT-141	61-1022	GEN-317
61-0908	ENT-143	61-0934	ENT-141	61-1023	GEN-317
61-0909	ENT-143	61-0934E	ENT-141	61-1024	GEN-317
61-0910	ENT-142	61-0934.5	ENT-141	61-1025	GEN-317
61-0910E	ENT-142	61-0934.5E	ENT-141	61-1026	GEN-317
61-0911	ENT-142	61-0935	ENT-141	61-1027	GEN-317
61-0911E	ENT-142	61-0935E	ENT-141	61-1034	ENT-146
61-0912	ENT-142	61-0936	ENT-141	61-1035	ENT-146, GEN-324
61-0912E	ENT-142	61-0936E	ENT-141	61-1036	ENT-146, GEN-324
61-0913	ENT-142	61-0937	ENT-141	61-1037	ENT-146, GEN-324
61-0913E	ENT-142	61-0937E	ENT-141	61-1038	ENT-146, GEN-324
61-0914	ENT-142	61-0939	ENT-145	61-1039	ENT-146, GEN-324
61-0914E	ENT-142	61-0941	ENT-144	61-1040	ENT-146, GEN-324
61-0915	ENT-142	61-0942	ENT-144	61-1041	ENT-146, GEN-324
61-0915E	ENT-142	61-0943	ENT-144	61-1042	ENT-146, GEN-324
61-0916	ENT-142	61-0944	ENT-144	61-1043	ENT-146, GEN-324
61-0916E	ENT-142	61-0946	ENT-145	61-1045	ENT-7, ENT-146
61-0917	ENT-142	61-0947	ENT-145	61-1050	GEN-321
61-0917E	ENT-142	61-0948	ENT-145	61-1053	GEN-321
61-0918	ENT-142	61-0949	ENT-145	61-1067	GEN-315
61-0918E	ENT-142	61-0950	ENT-144	61-1287	ENT-54
61-0919	ENT-142	61-0953	ENT-144	61-1288	ENT-54
61-0919E	ENT-142	61-0954	ENT-144	61-1290	ENT-54
61-0920	ENT-142	61-0955	ENT-144	61-2001	ENT-148
61-0920E	ENT-142	61-0956	ENT-144	61-2004	ENT-148
61-0921	ENT-142	61-0958	ENT-144	61-2005	ENT-148
61-0921E	ENT-142	61-0959	ENT-144	61-2006	ENT-148
61-0922	ENT-142	61-0960	ENT-144	61-2515	SPN-186
61-0922E	ENT-142	61-0961	ENT-144		

61-2516	SPN-186	62-2220L	GEN-315	63-0306.....	ENT-69
61-2525.....	OBE-79, SPN-186	62-2220S	GEN-316	63-0307.....	ENT-69
61-3710	ENT-22	62-2230	GEN-326	63-0313.....	ENT-64
61-3725.....	ENT-16	62-2231.....	GEN-326	63-0401.....	ENT-28
61-3750.....	ENT-84	62-4990.....	ENT-71	63-0402.....	ENT-28
61-3752.....	ENT-84	62-6203.....	ENT-119	63-0409.....	ENT-12
61-3770.....	ENT-67	62-6204.....	ENT-119	63-0494.....	ENT-105
61-3775.....	ENT-16	62-6205.....	ENT-119	63-0495.....	ENT-105
61-3789.....	ENT-77	62-6206.....	ENT-119	63-0496.....	ENT-105
61-3810.....	ENT-92	62-6251.....	ENT-121	63-0498.....	ENT-105
61-3812.....	ENT-92	62-6252.....	ENT-121	63-0499.....	ENT-105
61-3835.....	ENT-8	63-0010.....	ENT-6	63-0500.....	ENT-105
61-4122.....	ENT-54	63-0058.....	ENT-14	63-0501.....	ENT-105
61-7723.....	ENT-93	63-0084.....	ENT-6	63-0503.....	ENT-104
62-0380.....	ENT-138	63-0085.....	ENT-6	63-0504.....	ENT-104
62-0420.....	ENT-67	63-0088.....	ENT-6	63-0505.....	ENT-105
62-0425.....	ENT-66	63-0089.....	ENT-6	63-0506.....	ENT-105
62-0440.....	ENT-67	63-0090.....	ENT-6	63-0507.....	ENT-104
62-0470.....	ENT-71	63-0091.....	ENT-6	63-0508.....	ENT-104
62-0480.....	ENT-19	63-0092.....	ENT-87	63-0509.....	ENT-105
62-0481.....	ENT-74	63-0093.....	ENT-87	63-0510.....	ENT-105
62-0709.....	ENT-149	63-0094.....	ENT-87	63-0511.....	ENT-103
62-0710.....	ENT-149	63-0095.....	ENT-87	63-0512.....	ENT-103
62-0711.....	ENT-149	63-0096.....	ENT-87	63-0516.....	ENT-103
62-0712.....	ENT-149	63-0097.....	ENT-87	63-0518.....	ENT-103
62-0713.....	ENT-149	63-0098.....	ENT-87	63-0520.....	ENT-103
62-0714.....	ENT-149	63-0099.....	ENT-87	63-0522.....	ENT-103
62-0715.....	ENT-149	63-0100.....	ENT-87	63-0550.....	ENT-105
62-1209.....	ENT-11	63-0101.....	ENT-87	63-0551.....	ENT-105
62-1210.....	ENT-11	63-0102.....	ENT-87	63-0560.....	ENT-101
62-1211.....	ENT-11, ENT-83	63-0103.....	ENT-86	63-0569.....	ENT-47
62-1212.....	ENT-11	63-0104.....	ENT-86	63-0812.....	ENT-77
62-1213.....	ENT-11	63-0105.....	ENT-86	63-0813.....	ENT-77
62-1309.....	ENT-11	63-0106.....	ENT-86	63-0814.....	ENT-77
62-1310.....	ENT-11	63-0107.....	ENT-87	63-2002.....	ENT-59
62-1311.....	ENT-11	63-0108.....	ENT-87	63-2003.....	ENT-59
62-1312.....	ENT-11	63-0109.....	ENT-87	63-2009.....	ENT-57
62-1313.....	ENT-11	63-0112.....	ENT-89	63-2009S.....	ENT-57
62-1401.....	ENT-79	63-0115.....	ENT-88	63-2010.....	ENT-57
62-1402.....	ENT-79	63-0116.....	ENT-88	63-2010S.....	ENT-57
62-1403.....	ENT-79	63-0117.....	ENT-88	63-2011.....	ENT-57
62-1431.....	ENT-12	63-0118.....	ENT-88	63-2011S.....	ENT-57
62-1432.....	ENT-12	63-0119.....	ENT-86	63-2012.....	ENT-57
62-1470.....	ENT-12	63-0120.....	ENT-86	63-2012S.....	ENT-57
62-1520.....	ENT-20	63-0121.....	ENT-87	63-2017.....	ENT-58
62-1585.....	ENT-19	63-0122.....	ENT-87	63-2019.....	ENT-56
62-1650.....	ENT-65	63-0151.....	ENT-88	63-2020.....	ENT-56
62-1651.....	ENT-65	63-0200.....	O/A-60	63-2020S.....	ENT-56
62-1652.....	ENT-65	63-0205.....	O/A-59	63-2021.....	ENT-56
62-2210.....	GEN-315	63-0206.....	O/A-59	63-2026.....	ENT-56
62-2210L.....	GEN-315	63-0207.....	O/A-59	63-2181.....	ENT-140
62-2210S.....	GEN-316	63-0208.....	O/A-61	63-2182.....	ENT-140
62-2215.....	GEN-315	63-0208C.....	O/A-62	63-2183.....	ENT-140
62-2215L.....	GEN-315	63-0302.....	ENT-68	63-2184.....	ENT-140
62-2215S.....	GEN-316	63-0303.....	ENT-68	63-3710.....	ENT-88
62-2220.....	GEN-315	63-0304.....	ENT-68	63-3712.....	ENT-88

- 63-3714.....ENT-88
63-3716.....ENT-88
63-4003.....ENT-112, RET-88
63-4004.....ENT-112, RET-88
63-4005.....ENT-112, RET-88
63-4010.....ENT-106, RET-43
63-4017.....ENT-115, RET-119
63-4018.....ENT-115, RET-119
63-4019.....ENT-115, RET-119
63-4020.....ENT-115, RET-119
63-4022.....ENT-111, RET-39
63-4031.....CVT-222
63-5007.....ENT-61
63-5009.....ENT-61
63-5010.....ENT-119
63-5701.....ENT-44
63-5702.....ENT-44
63-5703.....ENT-44
63-5704.....ENT-45
63-5705.....ENT-45
63-5706.....ENT-45
63-5730.....ENT-61
63-5731.....ENT-61
63-5732.....ENT-61
63-5733.....ENT-61
63-5734.....ENT-61
63-5735.....ENT-61
63-5736.....ENT-61
63-5737.....ENT-61
63-6235.....ENT-139
63-6241.....ENT-139
63-6242.....ENT-139
63-6243.....ENT-139
63-6244.....ENT-139
63-6250.....ENT-139
63-6265.....ENT-140, RET-108
63-6266.....ENT-140, RET-108
63-6267.....ENT-140, RET-108
63-6268.....ENT-140, RET-108
63-6270.....ENT-140
63-6600.....ENT-58
63-6602.....ENT-58
63-6610.....ENT-58
63-6611.....ENT-58
63-6612.....ENT-58
63-6613.....ENT-58
63-6618.....ENT-58
63-7415.....ENT-98, PED-21
63-7416.....ENT-98, PED-21
63-7420.....ENT-98, PED-21
63-7421.....ENT-98, PED-21
63-7422.....ENT-98, PED-21
63-7423.....ENT-58, PED-15
63-7423S.....ENT-58, PED-15
63-7424.....ENT-58, PED-15
63-7424S.....ENT-58, PED-15
63-7425.....PED-15
63-7425S.....ENT-58
63-7451.....ENT-98
63-7452.....ENT-98
63-7453.....ENT-61, ENT-97
63-7454.....ENT-97
63-7455.....ENT-61, ENT-97
63-7460.....ENT-62
63-7500.....ENT-18
63-7505.....ENT-17
63-7510.....ENT-17
63-7512.....ENT-17
63-7515.....ENT-17
63-7520.....ENT-17
63-7535.....ENT-17
63-7540.....ENT-17
63-7553.....GEN-319
63-7554.....GEN-319
63-7557.....GEN-319
63-7558.....GEN-319
63-7559.....GEN-319
63-7560.....ENT-5
63-7562.....ENT-5
63-7564.....ENT-5
63-7565.....ENT-5
63-7566.....ENT-5
63-7567.....ENT-5
63-7570.....ENT-147
63-7580.....ENT-78
63-7582.....ENT-78
63-7591.....ENT-85
63-7610.....ENT-97
63-7615.....ENT-97
63-7620.....ENT-98
63-7625.....ENT-97
63-7626.....ENT-97
63-7627.....ENT-97
63-7630.....ENT-97
63-7631.....ENT-97
63-7634.....ENT-57
63-7635.....ENT-57
63-7700.....ENT-133, PED-38
63-7701.....ENT-133, PED-38
63-7702.....ENT-133, PED-38
63-7705.....ENT-133
63-7706.....ENT-133
63-7707.....ENT-133
63-8011.....CVT-68
63-8805.....ENT-13
63-8810.....ENT-13
63-8815.....ENT-13
63-8820.....ENT-94
63-8825.....ENT-94
63-8845.....ENT-50
63-8850.....ENT-50
63-8855.....ENT-50
63-8865.....ENT-50
63-8870.....ENT-50
63-8875.....ENT-50
63-8880.....ENT-50
64-1000.....GEN-152, NEU-59
64-1069L.....LAP-60
64-2503.....CVT-131, GEN-164
64-2509.....CVT-128, GEN-155,
PED-20
64-2511.....PED-20
64-2512.....CVT-131, GEN-164
64-2513.....CVT-131, GEN-164
64-2570.....CVT-128
64-2595.....CVT-130, GEN-160
64-6558.....CVT-129, GEN-159
65-848.....GEN-304
65-1001.....GEN-24, NEU-23,
O/A-24, SPN-51
65-1002.....GEN-24, NEU-23,
O/A-24, SPN-51
65-1003.....GEN-24, NEU-23,
O/A-24, SPN-51
65-1005.....GEN-26
65-1006.....GEN-26, NEU-26
65-1015.....CVT-69, NEU-16,
SPN-40
65-1016.....CVT-69, NEU-16,
SPN-40
65-1017.....CVT-69, NEU-16,
SPN-40
65-1018.....CVT-69, NEU-16,
SPN-40
65-1019.....CVT-69, NEU-16,
OBE-19, SPN-40
65-1030.....GEN-22, O/A-21
65-1031.....GEN-22, NEU-22,
O/A-21, SPN-48
65-1032.....GEN-22, NEU-22,
O/A-21, SPN-48
65-1033.....GEN-22, O/A-21,
SPN-48
65-1038.....CVT-69, NEU-12,
SPN-40
65-1045.....GEN-23, NEU-26
65-1047.....GEN-22, NEU-23,
O/A-23, SPN-51
65-1048.....GEN-22, NEU-23,
O/A-23, SPN-51
65-1050.....GEN-23, NEU-23,
O/A-23, SPN-48, SPN-51
65-1056.....GEN-26, NEU-25,
O/A-27, SPN-56, SPN-73
65-1057.....GEN-26, NEU-25,
O/A-27, SPN-56, SPN-73
65-1058.....GEN-26, NEU-25,
O/A-27, SPN-56, SPN-73

65-1059.....GEN-26, O/A-27, SPN-56	65-2545SPN-50	66-5803.....ENT-17
65-1064NEU-25, O/A-21, SPN-107, SPN-56, SPN-72	65-2546SPN-50	66-5804.....ENT-17
65-1075.....GEN-23, NEU-23, O/A-23, SPN-51	65-2547SPN-50	66-5805.....ENT-17
65-1076.....GEN-23, NEU-23, O/A-23, SPN-51	65-2549GEN-22, NEU-22, O/A-22, PED-8, SPN-48	66-5806.....ENT-17
65-1080NEU-24, O/A-24, SPN-52	65-6600.....RET-148	66-6022.....ENT-4
65-1100 GEN-23, NEU-121	65-6620 GEN-24	66-6042.....ENT-5
65-1101..... GEN-24, NEU-121	66-102NEU-123	66-6047.....ENT-148
65-1102 GEN-24	66-0301ENT-139	66-6232ENT-102
65-1104GEN-23, NEU-121	66-0302.....ENT-139	66-6233ENT-102
65-1110.....GEN-25, NEU-24, O/A-26	66-0303.....ENT-139	66-6234.....ENT-102
65-1115GEN-25, NEU-24, O/A-26, SPN-53	66-1025.....NEU-123	66-6500.....ENT-28
65-1116.....GEN-25, NEU-24, O/A-26, SPN-53	66-1026.....NEU-123	66-6650.....ENT-108, RET-66
65-1121NEU-25, O/A-16, SPN-57, SPN-73	66-1027.....NEU-123	66-6651ENT-108, RET-66
65-1135GEN-22, NEU-122, SPN-95	66-1510ENT-138	67-008ENG-54
65-2402 CVT-69, NEU-12, SPN-42	66-1512-3.....ENT-138	67-0230ENT-138
65-2403 CVT-69, NEU-12, SPN-42	66-1512-4ENT-138	67-0235ENT-138
65-2404 CVT-69, NEU-12, SPN-42	66-1512-5.....ENT-138	67-0242ENT-140
65-2405CVT-68, CVT-69, NEU-12, SPN-42	66-1512-6ENT-138	67-0255ENT-138
65-2407CVT-82, GEN-115, OBE-25	66-2030.....ENT-56	67-0270ENT-138
65-2413CVT-108, GEN-114, PED-46	66-2251.....ENT-56	67-0275ENT-138
65-2414CVT-130, GEN-147	66-2502ENT-60	67-0290ENT-138
65-2415 CVT-118, GEN-116	66-2519.....ENT-59	67-1020ENT-77
65-2416CVT-200, GEN-263	66-2540ENT-62	67-1030ENT-72
65-2418 CVT-118, GEN-115, PED-13	66-2560ENT-60	67-1033ENT-77
65-2419 CVT-118, GEN-115, PED-13	66-2565ENT-60	67-1035ENT-72
65-2420CVT-108, GEN-112, PED-49	66-2566ENT-60	67-1060.....ENT-72
65-2423 GEN-21, NEU-22	66-2599ENT-46	67-1065.....ENT-73
65-2510.....GEN-25, NEU-24, O/A-25, SPN-53	66-2810ENT-57	67-1080.....ENT-74
65-2511GEN-25, NEU-24, O/A-25, SPN-53	66-2810SENT-57	67-1097RC.....LAP-21
65-2512GEN-25, NEU-24, O/A-25, SPN-53	66-2811ENT-57	67-1550.....ENT-26
65-2513GEN-25, NEU-24, O/A-25, SPN-53	66-2811S.....ENT-57	67-1551.....ENT-26
65-2514GEN-25, NEU-24, O/A-25	66-2812.....ENT-57	67-1570ENT-24
	66-2812SENT-57	67-1575ENT-26
	66-2813.....ENT-57	67-1623ENT-26
	66-2813SENT-57	67-1749ENT-20
	66-3110ENT-63	67-1750ENT-21
	66-3121ENT-59	67-1770ENT-26
	66-3810ENT-99	67-1890.....ENT-25
	66-3812.....ENT-100	67-1891ENT-25
	66-5003.....ENT-78	67-1970ENT-8
	66-5004.....ENT-78	67-2003ENT-64
	66-5005.....ENT-78	67-2010.....ENT-114, RET-44
	66-5013.....ENT-78	67-2021.....ENT-106, RET-45
	66-5014ENT-78	67-2022ENT-106, RET-45
	66-5015.....ENT-78	67-2023ENT-70
	66-5201.....ENT-78	67-2025ENT-110, RET-49
	66-5208.....ENT-78	67-2044ENT-112, RET-39
	66-5210.....ENT-78	67-2050RET-54
	66-5430.....ENT-28	67-2051.....ENT-107, RET-54
	66-5450.....ENT-29	67-2052ENT-107, RET-45
	66-5455ENT-29	67-2115.....ENT-115, RET-45
	66-5490.....ENT-21	67-2121FS.....RET-40, RET-41
	66-5500.....ENT-29	67-2135ENT-106, RET-39
	66-5801ENT-17	67-2136ENT-106, RET-39
	66-5802ENT-17	67-2137FO.....ENT-106, RET-89
		67-2229FS.....RET-41

67-2230FS.....	RET-41	67-6010.....	ENT-123	67-7144.....	OBE-13, SPN-35
67-2231FS.....	RET-40, RET-41	67-6011.....	ENT-123	67-7145.....	OBE-13, SPN-35
67-2338FS.....	RET-40	67-6012.....	ENT-123	67-7146.....	SPN-35
67-2339FS.....	RET-40	67-6021.....	ENT-123	67-7147.....	OBE-13, SPN-35
67-2340FS.....	RET-40	67-6022.....	ENT-123	67-7148.....	OBE-13, SPN-35
67-2420FS.....	RET-41	67-6051.....	ENT-102	67-7149.....	OBE-13, SPN-35, SPN-41
67-2422FS.....	RET-41	67-6052.....	ENT-102	67-7150.....	OBE-13, SPN-35
67-2423FS.....	RET-41	67-6053.....	ENT-102	67-7151.....	OBE-13, SPN-35
67-2425FS.....	RET-41	67-6054.....	ENT-102	67-7152.....	OBE-13, SPN-35
67-2427FS.....	RET-41	67-6055.....	ENT-102	67-7153.....	OBE-13, SPN-36
67-2490.....	RET-62	67-6056.....	ENT-102	67-7154.....	OBE-13, SPN-36
67-2492.....	RET-62	67-6218.....	SPN-92	67-7155.....	OBE-13, SPN-36
67-2512FS.....	RET-40	67-6513.....	ENT-60	67-7156.....	OBE-13, SPN-36
67-3102.....	ENT-86	67-6520.....	ENT-60	67-7157.....	OBE-13, SPN-36
67-3104.....	ENT-86	67-6705.....	OBGYN-17	67-7158.....	OBE-13, SPN-36
67-3106.....	ENT-86	67-6707.....	OBE-33	67-7159.....	OBE-13, SPN-36
67-3108.....	ENT-86	67-7001.....	OBE-2, SPN-3	67-7160.....	OBE-13, SPN-36
67-3110.....	ENT-86	67-7003.....	OBE-2, SPN-6	67-7161.....	OBE-13, SPN-36
67-3112.....	ENT-86	67-7018... O/A-4, OBE-2, SPN-4		67-7162.....	OBE-13, SPN-36
67-3810.....	ENT-88	67-7028.....	SPN-49	67-7163.....	OBE-13, SPN-36
67-3811.....	ENT-88	67-7029.....	SPN-49	67-7164.....	OBE-13, SPN-36
67-3812.....	ENT-88	67-7030.....	SPN-49	67-7165.....	OBE-13, SPN-36
67-4020.....	ENT-79	67-7031.....	SPN-49	67-7166.....	OBE-13, SPN-36
67-5013.....	ENT-126	67-7032.....	SPN-49	67-7167.....	OBE-13, SPN-36
67-5112.....	ENT-130	67-7033.....	SPN-49	67-7168.....	OBE-13, SPN-36
67-5120.....	ENT-124	67-7034.....	SPN-51	67-7169.....	OBE-13, SPN-36
67-5121.....	ENT-124	67-7035.....	SPN-51	67-7170.....	OBE-13, SPN-36
67-5154.....	ENT-127	67-7036.....	SPN-51	67-7171.....	OBE-11, SPN-37
67-5155.....	ENT-127	67-7037.....	SPN-51	67-7172.....	OBE-11, SPN-37
67-5211.....	ENT-128	67-7038.....	OBE-22	67-7173.....	OBE-11, SPN-37
67-5212.....	ENT-128	67-7039.....	OBE-22, SPN-58	67-7174.....	OBE-11, SPN-37
67-5313.....	ENT-126	67-7104.....	SPN-34	67-7175.....	OBE-11, SPN-37
67-5316.....	ENT-125	67-7105.....	SPN-34	67-7176.....	OBE-11, SPN-37
67-5371.....	ENT-132	67-7106.....	SPN-34	67-7177.....	OBE-11, SPN-37
67-5503.....	ENT-130	67-7107.....	SPN-34	67-7178.....	OBE-11, SPN-37
67-5504.....	ENT-136	67-7108.....	SPN-34	67-7179.....	OBE-11, SPN-37
67-5505.....	ENT-132	67-7109.....	SPN-34	67-7186.....	SPN-29
67-5506.....	ENT-130	67-7110.....	SPN-34	67-7187.....	SPN-29
67-5507.....	ENT-137	67-7111.....	SPN-34	67-7188.....	SPN-29
67-5508.....	ENT-125	67-7112.....	SPN-34	67-7189.....	SPN-29
67-5509.....	ENT-132	67-7113.....	SPN-34	67-7190.....	SPN-29
67-5511.....	ENT-125	67-7114.....	SPN-34	67-7191.....	SPN-29
67-5513.....	ENT-130	67-7115.....	SPN-34	67-7192.....	SPN-29
67-5515.....	ENT-136	67-7116.....	SPN-34	67-7193.....	SPN-29
67-5516.....	ENT-130	67-7117.....	SPN-34	67-7194.....	SPN-29
67-5860.....	ENT-7	67-7118.....	SPN-34	67-7209.....	SPN-29
67-5911.....	ENT-102	67-7119.....	SPN-34	67-7211.....	SPN-29
67-5912.....	ENT-102	67-7120.....	SPN-34	67-7212.....	SPN-29
67-5920.....	ENT-102	67-7121.....	SPN-34	67-7213.....	SPN-29
67-5930.....	ENT-104	67-7122.....	SPN-34	67-7214.....	SPN-29
67-5935.....	ENT-103	67-7139.....	OBE-13, SPN-35	67-7215.....	SPN-29
67-5940.....	ENT-103	67-7140.....	OBE-13, SPN-35, SPN-41	67-7216.....	SPN-29
67-5941.....	ENT-101	67-7141.....	OBE-13, SPN-35	67-7218.....	SPN-28
67-5942.....	ENT-101	67-7142.....	OBE-13, SPN-35	67-7219.....	SPN-28
67-5960.....	ENT-101	67-7143.....	OBE-13, SPN-35	67-7220.....	SPN-28
67-5970.....	ENT-104				

67-7221.....	SPN-29	67-7394.....	CVT-66	67-7505.....	OBE-47
67-7239.....	NEU-87, OBE-71, SPN-141	67-7395.....	CVT-66	67-7510.....	OBE-47
67-7240.....	NEU-87, OBE-71, SPN-141	67-7396.....	CVT-66	67-7523.....	CVT-48, OBE-8
67-7241.....	OBE-71, SPN-141	67-7397.....	CVT-66	67-7524.....	CVT-48, OBE-8
67-7242.....	OBE-71, SPN-141	67-7398.....	CVT-66	67-7525.....	CVT-27, OBE-4
67-7267.....	SPN-161	67-7410.....	SPN-39	67-7526.....	CVT-27, OBE-4
67-7270.....	SPN-161	67-7411.....	SPN-39, SPN-41	67-7527.....	OBE-5
67-7273.....	SPN-161	67-7412.....	SPN-41	67-7528.....	OBE-5
67-7276.....	SPN-161	67-7413.....	SPN-41	67-7529.....	OBE-5
67-7282.....	SPN-171	67-7414.....	SPN-41	67-7530.....	OBE-5
67-7285.....	SPN-171	67-7415.....	SPN-41	67-7531.....	OBE-5
67-7288.....	SPN-171	67-7416.....	SPN-41	67-7532.....	OBE-5
67-7309.....	SPN-170, SPN-171	67-7417.....	SPN-41	67-7533.....	CVT-32, OBE-5
67-7310.....	SPN-170, SPN-171	67-7418.....	SPN-39, SPN-41	67-7534.....	CVT-34, OBE-6
67-7311.....	SPN-170, SPN-171	67-7419.....	SPN-39	67-7535.....	CVT-34, OBE-6
67-7312.....	SPN-170, SPN-171	67-7428.....	OBE-35, SPN-67	67-7564.....	CVT-7
67-7313.....	SPN-170, SPN-171	67-7429.....	NEU-44, OBE-35, SPN-67	67-7567.....	OBE-3
67-7314.....	SPN-170, SPN-171	67-7430.....	NEU-46, OBE-35, SPN-68	67-7579.....	OBE-31
67-7315.....	SPN-170, SPN-171	67-7431.....	NEU-47, OBE-35, SPN-68	67-7580.....	OBE-31
67-7316.....	SPN-170, SPN-171	67-7432.....	NEU-47, OBE-35, SPN-68	67-7581.....	OBE-31
67-7317.....	SPN-170, SPN-171	67-7433.....	NEU-49, OBE-36, SPN-68	67-7582.....	GEN-111
67-7318.....	SPN-170, SPN-171	67-7434.....	NEU-49, OBE-36, SPN-68	67-7583.....	NEU-39
67-7319.....	OBE-68, OBE-70, SPN-146, SPN-150	67-7435.....	NEU-49, OBE-36, SPN-68	67-7584.....	CVT-94, GEN-103, OBE-25
67-7320.....	OBE-68, OBE-70, SPN-146, SPN-150	67-7436.....	NEU-49, OBE-36, SPN-69	67-7585.....	CVT-94, GEN-103, OBE-25
67-7321.....	OBE-69, OBE-70, SPN-146, SPN-154	67-7437.....	NEU-49, OBE-36, SPN-69	67-7586.....	CVT-94, GEN-103, OBE-25
67-7322.....	OBE-69, OBE-70, SPN-146	67-7438.....	NEU-49, OBE-36, SPN-69	67-7587.....	CVT-94, GEN-103, OBE-25
67-7323.....	SPN-147, SPN-176	67-7440.....	OBE-35	67-7601.....	OBE-26
67-7324.....	OBE-67, SPN-144, SPN-147	67-7470.....	OBE-49	67-7602.....	OBE-28, OBGYN-17
67-7325.....	OBE-69, SPN-171	67-7471.....	OBE-49	67-7605.....	OBE-28
67-7326.....	OBE-69, SPN-171	67-7482.....	OBE-47	67-7606.....	OBE-33
67-7327.....	OBE-69, SPN-171	67-7483.....	OBE-48	67-7608.....	OBE-30
67-7328.....	OBE-69, SPN-171	67-7484.....	OBE-48	67-7609.....	OBE-34
67-7329.....	OBE-69, SPN-171	67-7485.....	OBE-48	67-7614.....	OBE-33
67-7330.....	OBE-69, SPN-171	67-7486.....	OBE-48	67-7623.....	OBE-39
67-7331.....	OBE-69, SPN-171	67-7487.....	OBE-48	67-7624.....	OBE-39
67-7332.....	OBE-69, SPN-171	67-7488.....	OBE-48	67-7663.....	OBE-72
67-7333.....	OBE-69, SPN-171	67-7498.....	OBE-46	67-7664.....	OBE-72
67-7334.....	OBE-69, SPN-171	67-7499.....	CVT-142, GEN-188, RET-10, RET-17	67-7665.....	CVT-207, OBE-72
67-7354.....	OBGYN-11	67-7500.....	CVT-142, GEN-188, RET-10, RET-17	67-7675.....	CVT-223, GEN-315, OBE-79, OBE-81
67-7356.....	OBGYN-11	67-7502.....	CVT-142, GEN-188, RET-10, RET-17	67-7677.....	CVT-223, OBE-81
67-7357.....	OBGYN-11	67-7504.....	CVT-142, GEN-188, RET-10, RET-17, RET-137, SPN-113	67-7731.....	SPN-171
67-7358.....	OBGYN-11			67-7732.....	SPN-154
67-7359.....	OBGYN-11			67-7800.....	CVT-94, GEN-121, OBE-31
67-7367.....	OBGYN-11			67-7801.....	CVT-94, GEN-121, OBE-31
67-7369.....	OBGYN-11			67-7802.....	CVT-94, GEN-121, OBE-31
67-7390.....	CVT-66			67-7803.....	CVT-94, GEN-121, OBE-31
67-7391.....	CVT-66			67-7850.....	GEN-320, NEU-130
67-7392.....	CVT-66				
67-7393.....	CVT-66				

- 67-7851 GEN-320, NEU-130
67-7852 GEN-320, NEU-130
67-7853 GEN-320, NEU-130
67-7854 GEN-320, NEU-130
67-7855 GEN-320, NEU-130
67-7856 GEN-320, NEU-130
67-7857 GEN-320, NEU-130
67-7858 GEN-320, NEU-130
67-7859 GEN-320, NEU-130
67-7860 GEN-320, NEU-130
67-7861 GEN-320, NEU-130
67-7862 GEN-320, NEU-128,
NEU-130
67-7863 GEN-320, NEU-128,
NEU-130
67-7864 GEN-320, NEU-130
67-7865 GEN-320, NEU-130
67-7866 GEN-320, NEU-130
67-7867 GEN-320, NEU-130
67-7868 GEN-321, NEU-130,
SPN-188
67-7869 GEN-321, NEU-130,
SPN-188
67-7870 GEN-321, NEU-130,
SPN-188
67-7871 GEN-321, NEU-130,
SPN-188
67-7872 GEN-321, NEU-130,
SPN-188
67-7873 GEN-321, NEU-130,
SPN-188
67-7900 OBE-72, SPN-177
67-7901 OBE-72, SPN-177
67-7902 OBE-72, SPN-177
67-7903 OBE-72, SPN-177
67-7904 OBE-72, SPN-177
67-7905 OBE-72, SPN-177
67-7906 OBE-73, SPN-140
67-7907 OBE-73, SPN-140
67-7908 OBE-73, SPN-140
67-7909 OBE-73, SPN-140
67-7910 OBE-73, SPN-140
67-7911 OBE-73, SPN-140
67-7912 OBE-73, SPN-177
67-7913 NEU-106, OBE-73,
SPN-177
67-7914 NEU-106, OBE-73,
SPN-177
67-7915 NEU-106, OBE-73,
SPN-177
67-7916 NEU-106, OBE-73,
SPN-177
67-7917 NEU-106, OBE-73
67-7918 OBE-73, SPN-140
67-7919 OBE-73, SPN-140
67-7920 OBE-73, SPN-140
67-7921 OBE-73, SPN-140
67-7922 OBE-73, SPN-140
67-7923 OBE-73, SPN-140
67-8000 CVT-225
67-8001 CVT-225
67-8004 CVT-225, PED-49
68-0004 ENT-11
68-0225 ENT-11
68-0227 ENT-11
68-0228 ENT-11
68-0298 ENT-27
68-0393 ENT-25
68-0404 ENT-6
68-0410 ENT-3
68-0905 ENT-24
68-0920 ENT-27
68-1002 SS-38
68-1006 RET-54
68-1212 ENT-83
68-1214 ENT-83
68-1505 ENT-3
68-1510 ENT-3
68-1590 GEN-210
68-1591 GEN-210
68-1593 GEN-210, LAP-23,
RET-73
68-1594 GEN-210, LAP-23,
RET-73
68-1598 LAP-95, SS-40
68-1599 LAP-95, SS-40
68-4510 ENT-27
68-5001 ENT-51
68-5002 ENT-51
68-6072 NEU-11
69-6218 ENT-94
69-7917 SPN-177
70-1005 GEN-319, NEU-132,
PED-44
70-1006 GEN-319, NEU-132
70-1007 NEU-132
70-1015 NEU-132
70-1016 NEU-132
70-1017 NEU-132, PED-44
70-1079 GEN-319, NEU-132,
PED-44
70-1080 GEN-319, NEU-132,
PED-44
70-1081 NEU-132, PED-44
70-1087 NEU-132, PED-44
70-1088 NEU-132
70-1089 NEU-132, PED-44
70-1100 GEN-319, NEU-132
70-1101 GEN-319, NEU-132,
PED-44
70-1102 GEN-319, NEU-132,
PED-44
70-1103 GEN-322, NEU-132,
PED-44
70-1104 GEN-322, NEU-129
70-1128 GEN-323, NEU-133,
PED-44
70-1130 GEN-323, NEU-133,
PED-44
70-1146 GEN-314, NEU-131
70-1148 GEN-314, NEU-131
70-1160 GEN-325, NEU-133,
OBE-80
70-1161 GEN-325, NEU-133,
OBE-80
70-4000 CVT-223, GEN-323
70-4001 CVT-223, GEN-323,
OBE-79
70-4002 CVT-223, GEN-323,
OBE-79
70-4024 CVT-224, GEN-327,
OBE-80
70-4026 CVT-224, GEN-327,
OBE-80
70-4142 CVT-224
70-6560 CVT-223, GEN-315,
OBE-79
70-8036 CVT-225, GEN-327
70-8040 CVT-224, GEN-322,
OBE-81
70-8048 CVT-223, GEN-322
71-1000 ENT-2
71-1010 ENT-2
71-1011 ENT-2
71-1012 ENT-2
71-1013 ENT-2
71-1050 ENT-2
71-1060 ENT-2
71-1061 ENT-2
71-1062 ENT-2
71-3208 ENT-10
71-3209 ENT-9
71-3610 ENT-9
71-3612 ENT-9
71-3614 ENT-9
71-3616 ENT-9
71-3618 ENT-9
71-3800 ENT-9
71-3801 ENT-9
71-3802 ENT-9
71-3810 ENT-9
71-3812 ENT-9
71-3814 ENT-9
71-3816 ENT-9
71-3818 ENT-9
71-4001 ENT-96
71-4002 ENT-96
71-4111 ENT-10

71-4113	ENT-10	72-9514	ENT-85	74-5974	ENT-128
71-4115	ENT-10	73-4005	CVT-227	74-5975	ENT-128
71-5001	ENT-96	73-4808	ENT-80	74-5976	ENT-128
71-5002	ENT-96	73-4810	ENT-80	74-5977	ENT-128
71-5018	ENT-63	73-4812	ENT-80	74-6019	ENT-52
71-5220	ENT-96	73-4814	ENT-80	74-6020	ENT-52
71-5222	ENT-96	73-4816	ENT-80	74-6024	ENT-52
71-6318	ENT-117, RET-150	73-4818	ENT-80	74-6028	ENT-129
71-6320	ENT-117, RET-150	73-4820	ENT-80	74-6030	ENT-129
71-6348	ENT-117, RET-150	73-4822	ENT-80	74-6031	ENT-129
71-6360	ENT-117	73-4824	ENT-80	74-6035	ENT-129
72-0210	ENT-118, RET-61	73-4826	ENT-80	74-6036	ENT-129
72-0240	ENT-106, RET-37	73-4828	ENT-80	74-6037	ENT-129
72-0515	ENT-82, RET-75	73-6601	ENT-19	74-6038	ENT-129
72-0560	ENT-83	73-6602	ENT-19	74-6047	ENT-46
72-0560x	ENT-83	73-6603	ENT-18	74-6971	ENT-3
72-0561	ENT-83	73-6604	ENT-18	74-6972	ENT-3
72-0709	ENT-82	73-7233	GEN-51	74-6973	ENT-3
72-0711	ENT-82	74-3520	ENT-79	75-1003	NEU-112
72-0713	ENT-82	74-4510	ENT-73	75-1004	NEU-112
72-0715	ENT-82	74-4520	ENT-94	75-1012	NEU-113
72-0800	ENT-82	74-4521	ENT-94	75-1013	NEU-113
72-0801	ENT-82	74-5002	ENT-147	75-1018	NEU-112
72-0811	ENT-82	74-5005	ENT-147	75-1019	NEU-112
72-0812	ENT-82	74-5006	ENT-147	75-1020	NEU-112
72-0813	ENT-82	74-5007	ENT-147	76-0550	O/A-111
72-1002	ENT-62	74-5700	ENT-51	76-4001	O/A-111
72-1003	ENT-62	74-5706	ENT-51	76-4002	O/A-111
72-1004	ENT-62	74-5708	ENT-51	76-4003	O/A-111
72-1005	ENT-63	74-5710	ENT-51	76-4401	O/A-111
72-1007	ENT-63	74-5715	ENT-51	76-4402	O/A-111
72-2030	ENT-78	74-5716	ENT-51	76-4403	O/A-111
72-2522	ENT-112	74-5717	ENT-51	76-4573	O/A-110
72-2530	ENT-27	74-5718	ENT-51	77-1005	O/A-79, RET-89
72-2540	ENT-79	74-5757	ENT-50	77-1006	O/A-97, RET-80
72-4019	ENT-63	74-5800	ENT-50	77-1007	O/A-97, RET-80
72-4520	ENT-135	74-5801	ENT-50	77-1008	RET-90
72-4525	ENT-135	74-5920	ENT-53	77-1010	O/A-48
72-4550	ENT-135	74-5921	ENT-53	77-1011	O/A-79, RET-94
72-5051	ENT-138	74-5922	ENT-53	77-1013	RET-95
72-6011	ENT-138	74-5923	ENT-53	77-1014	O/A-85, RET-55
72-6012-6	ENT-138	74-5925	ENT-52	77-1015	O/A-78, RET-38
72-6012-7	ENT-138	74-5926	ENT-52	77-1020	O/A-48
72-6012-8	ENT-138	74-5927	ENT-52	77-1028	O/A-48
72-6012-9	ENT-138	74-5928	ENT-52	77-1029	O/A-48
72-6046	ENT-146	74-5931	ENT-128	77-1030	O/A-48
72-6053	ENT-148	74-5932	ENT-128	77-1032	O/A-48
72-6054	ENT-148	74-5934	ENT-128	77-1035	O/A-48
72-6055	ENT-148	74-5935	ENT-128	77-1040	O/A-48
72-6179	ENT-95	74-5936	ENT-45	77-1041	O/A-48
72-6455	ENT-146	74-5960	ENT-52	77-1044	O/A-48
72-6457	ENT-146	74-5962	ENT-52	77-1050	O/A-91, RET-90
72-6515	ENT-138	74-5963	ENT-52	77-1052	O/A-91, RET-90
72-6516	ENT-138	74-5964	ENT-52	77-1110	RET-90
72-6517	ENT-138	74-5971	ENT-52	77-1118	GEN-225, RET-90
72-9510	ENT-85	74-5972	ENT-52	77-1120	O/A-81, RET-90

- 77-1122.....O/A-81, RET-90
77-1124.....RET-90
77-1125.....RET-90
77-1142.....RET-90
77-1165.....RET-90
77-1167.....RET-90
77-1188.....O/A-80, RET-96
77-1189.....O/A-80, RET-96
77-1190.....O/A-107, RET-94
77-1191.....O/A-83, RET-91
77-1193.....O/A-107, RET-90
77-1195.....RET-119
77-1204.....RET-89
77-1206.....O/A-78, RET-89
77-1241.....O/A-78, RET-89
77-1242.....O/A-78, RET-89
77-1243.....O/A-78, RET-89
77-1251.....O/A-78, RET-92
77-1252.....O/A-78, RET-92
77-1505.....O/A-47
77-2002.....O/A-32
77-2003.....O/A-77
77-2004.....O/A-76
77-2005.....O/A-77
77-2006.....O/A-77
77-2007.....O/A-32
77-2008.....O/A-32
77-2009.....O/A-32
77-2010.....O/A-32
77-2011.....O/A-32
77-2014.....O/A-49
77-4190.....O/A-108
77-5520.....O/A-106
77-5601.....O/A-90, RET-96
77-5602.....O/A-90, RET-96
77-5603.....O/A-90, RET-96
77-5610.....O/A-91, RET-96
77-5611.....O/A-91, RET-96
77-5621.....O/A-91, RET-96
77-5650.....O/A-89
77-6002.....O/A-80
77-6003.....O/A-80
77-6004.....O/A-80
77-6005.....O/A-80, RET-46
78-0012.....GEN-100
78-0025.....GEN-100
78-0040.....GEN-100
78-0045.....GEN-100
78-0047.....GEN-100
78-0050.....GEN-100
78-0055.....GEN-100
78-0060.....GEN-100
78-0065.....GEN-100
78-0070.....GEN-100
78-0075.....GEN-100
78-0086.....GEN-100
78-0095.....CVT-15
78-0096.....CVT-15
78-0106.....GEN-100
78-0142.....GEN-100
78-0220.....GEN-164
78-0306.....GEN-289
78-0310.....GEN-281
78-0318.....GEN-164
78-0320.....GEN-281
78-0330.....GEN-277
78-0345.....GEN-277
78-0350.....GEN-277
78-0355.....GEN-277
78-0365.....GEN-278
78-0510.....GEN-288
78-0515.....GEN-288
78-1115.....O/A-42
78-1119.....O/A-42
78-5009.....O/A-20
78-5011.....O/A-20
78-5013.....O/A-20
78-5015.....O/A-20
78-5017.....O/A-20
78-5599.....O/A-88, RET-65
78-5998.....O/A-90, RET-96
78-5999.....O/A-90, RET-96
79-0003.....CVT-62, SS-45
79-0004.....CVT-62, SS-45
79-5506.....OBGYN-46
79-5509.....OBGYN-46
79-5514.....OBGYN-50
79-5515.....OBGYN-50
79-5521.....OBGYN-51
79-5522.....OBGYN-51
79-5590.....OBGYN-50
79-5592.....OBGYN-46
79-6669.....ENT-139, RET-40
79-6675.....ENT-139, RET-40
79-6676.....ENT-139
79-6677.....ENT-139
79-7011.....ENT-140, RET-108
79-7012.....ENT-140, RET-108
79-7013.....ENT-140, RET-108
80-1001.....CVT-214, SPN-44,
SPN-72, SPN-107
80-1002.....CVT-214, NEU-17,
NEU-18
80-1003.....CVT-214
80-1004.....SPN-72, SPN-107
80-1005.....CVT-214
80-1006.....SPN-73
80-1012.....SPN-72, SPN-107,
SPN-195
80-1032.....CVT-214
80-1033.....CVT-214
80-1034.....CVT-214
80-1043.....CVT-204
80-1311.....NEU-27, NEU-135
80-1312.....NEU-27, NEU-135
80-1313.....NEU-53, NEU-136,
SPN-84
80-1314.....NEU-53, NEU-136
80-1315.....NEU-15, NEU-136
80-1316.....NEU-15, NEU-136
80-1325.....NEU-27, NEU-135
80-1326.....NEU-27, NEU-135
80-1328.....NEU-28, NEU-135
80-1329.....NEU-27, NEU-135
80-1330.....NEU-10, NEU-134
80-1331.....NEU-10, NEU-134
80-1332.....NEU-10, NEU-134
80-1333.....NEU-10, NEU-134
80-1334.....NEU-10, NEU-134
80-1335.....NEU-10, NEU-134
80-1336.....NEU-126, NEU-137
80-1337.....NEU-83, NEU-136,
RET-87
80-1340.....NEU-63
80-1341.....NEU-63
80-1342.....NEU-63
80-1343.....NEU-63
80-1344.....NEU-63
80-1345.....NEU-10, NEU-134
80-1346.....NEU-10, NEU-134
80-1347.....NEU-10, NEU-134
80-1348.....NEU-10, NEU-134
80-1350.....NEU-125, NEU-137
80-1351.....NEU-125, NEU-137
80-1352.....NEU-125, NEU-137
80-1355.....NEU-6, NEU-135,
SS-38
80-1360.....GEN-322, NEU-131
80-1361.....GEN-322, NEU-131
80-1366.....NEU-57
80-1500.....NEU-42
80-1501.....NEU-42
80-1502.....GEN-33, NEU-42
80-1503.....GEN-21, GEN-33,
NEU-42
80-1504.....GEN-33, NEU-42
80-1505.....GEN-33, NEU-43
80-1506.....GEN-33, NEU-42
80-1507.....GEN-33, NEU-43
80-1508.....NEU-42
80-1509.....GEN-33, NEU-42
80-1510.....GEN-148, NEU-60
80-1511.....GEN-148, NEU-60
80-1512.....GEN-148, NEU-60
80-1514.....GEN-148, NEU-60
80-1515.....GEN-148, NEU-60
80-1520.....GEN-290, NEU-119
80-1521.....GEN-290, NEU-119

80-1522..... GEN-290, NEU-119	NEU-22	80-1853..... CVT-90
80-1523..... GEN-290, NEU-119	80-1684 GEN-22, NEU-16,	80-1854 CVT-199
80-1524..... GEN-290, NEU-119	NEU-22	80-1855..... CVT-199
80-1525..... GEN-290, NEU-119	80-1685..... NEU-16	80-1856..... CVT-199
80-1526..... GEN-290, NEU-119	80-1686..... NEU-16	80-1857..... CVT-90
80-1527..... NEU-31	80-1687..... NEU-16	80-1858..... CVT-90
80-1528..... NEU-31	80-1688 NEU-16, NEU-49	80-1859..... CVT-90
80-1529..... NEU-31	80-1689 NEU-16, NEU-49	80-1861..... CVT-164, RET-34
80-1530 NEU-56	80-1690 NEU-16, NEU-49	80-1862..... CVT-164, RET-34
80-1531 NEU-49	80-1691..... NEU-61	80-1863 CVT-164, RET-34
80-1532..... NEU-49	80-1693..... NEU-16	80-1864 CVT-164, PED-23,
80-1533..... NEU-49	80-1696 NEU-16	RET-34
80-1534..... NEU-84, RET-159	80-1697..... NEU-16	80-1865..... CVT-57, SS-40
80-1535..... NEU-15	80-1698 NEU-16	80-1866 CVT-123, GEN-161
80-1536..... NEU-11	80-1699 NEU-16	80-1867..... CVT-123, GEN-161
80-1537..... GEN-21, NEU-26	80-1700 GEN-105, NEU-43	80-1868 CVT-123, GEN-161
80-1540 NEU-15	80-1701 GEN-105, NEU-43	80-1869 CVT-123, GEN-161
80-1541 NEU-15	80-1702..... GEN-105, NEU-43	80-1900 NEU-14
80-1542..... NEU-15	80-1703..... GEN-105, NEU-43	80-1901..... NEU-14
80-1543F CVT-204	80-1720..... GEN-290, NEU-120	80-1902 NEU-14
80-1560S NEU-84	80-1721 GEN-290, NEU-120	80-1905 GEN-108, NEU-36
80-1561S NEU-84	80-1722..... GEN-290, NEU-119	80-1906 GEN-108, NEU-36
80-1562 CVT-59, NEU-34, SS-41	80-1723..... GEN-290, NEU-119	80-1907 GEN-291, NEU-118
80-1563..... CVT-59, NEU-4,	80-1725..... GEN-149, NEU-58	80-1908 GEN-291, NEU-118
NEU-34, SS-41	80-1726..... GEN-149, NEU-58	80-1909 NEU-59
80-1564 . CVT-57, NEU-3, SS-41	80-1727..... GEN-149, NEU-58	80-1914 NEU-4, SS-42
80-1565.. CVT-57, NEU-3, SS-41	80-1728..... GEN-150, NEU-58	80-1961..... NEU-16
80-1567.. CVT-58, NEU-4, SS-41	80-1729..... GEN-150, NEU-58	80-1962..... NEU-16
80-1568..... SS-42	80-1731 GEN-105, NEU-33	80-2000 GEN-64, NEU-34,
80-1580 SS-41	80-1732..... CVT-82, GEN-49,	PED-14
80-1581 SS-41	NEU-32	80-2002..... CVT-124, GEN-143,
80-1582..... SS-41	80-1736..... GEN-106, NEU-40	NEU-34, NEU-60, PED-19
80-1583..... SS-41	80-1744..... GEN-290, NEU-119	80-2003..... CVT-124, GEN-143,
80-1584 SS-41	80-1745..... GEN-290, NEU-119	NEU-34, NEU-60, PED-19
80-1594..... SS-41	80-1746..... GEN-150, NEU-58	80-2005..... CVT-201, GEN-288,
80-1595..... SS-42	80-1747 GEN-150, NEU-58	NEU-34, NEU-115, PED-36
80-1597..... CVT-58	80-1748..... GEN-106, NEU-40	80-2006..... CVT-201, GEN-288,
80-1598..... CVT-58	80-1800 GEN-164, NEU-127	NEU-34, NEU-115, PED-36
80-1599..... CVT-58	80-1801..... GEN-307, NEU-127	80-2009..... GEN-64, NEU-34
80-1621 GEN-328, NEU-129	80-1802 GEN-307, NEU-127	80-2010 GEN-64, NEU-34,
80-1622..... GEN-328, NEU-129	80-1803 GEN-307, NEU-127	OPH-58
80-1650 NEU-84, SPN-129	80-1804 GEN-307, NEU-127	80-2011..... OPH-58
80-1651 NEU-84, SPN-129	80-1805 GEN-307, NEU-127	80-2012 GEN-164, NEU-34
80-1652..... NEU-84, SPN-129	80-1806 NEU-127	80-2013 GEN-164, NEU-34
80-1652S NEU-84	80-1807 NEU-127	80-2015 GEN-288, NEU-34
80-1653..... NEU-84, SPN-129	80-1812 CVT-172, GEN-245,	80-2016 GEN-288, NEU-34
80-1653S NEU-84	NEU-127, PED-26, RET-64	80-2018 NEU-34
80-1654 SPN-61	80-1813 CVT-172, GEN-245,	80-2019 NEU-34
80-1655..... SPN-129, SPN-188	NEU-127, PED-26, RET-64	80-2030..... NEU-34
80-1660 NEU-16	80-1818 NEU-127, SS-43	80-2031 NEU-34
80-1661. NEU-5, NEU-16, SS-43	80-1820 NEU-127	80-2060..... NEU-37, NEU-128
80-1679..... NEU-16	80-1830 CVT-58	80-2061 NEU-37, NEU-128
80-1680 NEU-16	80-1840 SS-44	80-2062..... NEU-37, NEU-128
80-1681..... NEU-16	80-1844 SS-44	80-2063..... NEU-37, NEU-128
80-1682..... NEU-16	80-1851..... CVT-90	80-2064..... NEU-37, NEU-128
80-1683 GEN-22, NEU-16,	80-1852..... CVT-90	80-2065..... NEU-37, NEU-128

- 80-2066..... NEU-41, NEU-128
80-2067..... NEU-128
80-2068..... NEU-41, NEU-128
80-2069..... NEU-60, NEU-128
80-2070..... NEU-60, NEU-128
80-2071..... NEU-128
80-2072..... NEU-120, NEU-128
80-2073..... NEU-120, NEU-128
80-2074..... NEU-120, NEU-128
80-2075..... NEU-55, NEU-128
80-2076..... NEU-55, NEU-128
80-2077..... NEU-55, NEU-128
80-2078..... NEU-11, NEU-128
80-2095..... GEN-287
80-2096..... GEN-287
80-2180..... GEN-257
80-2185..... GEN-257
80-3305..... GEN-276
80-3306..... GEN-276
80-3314..... GEN-276
80-3318..... GEN-276
80-3320..... GEN-276
80-3323..... GEN-276
80-3514..... GEN-276
80-3518..... GEN-276
80-3520..... GEN-276
80-3523..... GEN-276
80-3620..... GEN-296
80-4200..... ENT-131
80-4905..... ENT-131
80-5009..... GEN-297, OPH-59
80-5012..... GEN-297, OPH-59
80-5013..... GEN-297, OPH-59
80-5015..... ENT-131
80-5017..... GEN-268
80-5023..... GEN-268
80-5025..... GEN-297
80-5115..... GEN-280
80-5117..... GEN-268
80-5123..... GEN-268
80-5125..... GEN-297
80-5550..... OBGYN-13
80-6001..... CVT-83, GEN-115,
NEU-33, OBGYN-20, PED-14
80-6002..... CVT-83, GEN-115,
NEU-33, OBGYN-20, PED-14
80-6006..... CVT-129, GEN-146,
NEU-59, OBGYN-31, PED-20
80-6007..... CVT-129, GEN-146,
NEU-59, OBGYN-31, PED-20
80-6008..... CVT-198, GEN-282,
NEU-115, OBGYN-43, PED-36
80-6009..... CVT-198, GEN-282,
OBGYN-43, PED-36
80-6066..... GEN-280
80-6621..... CVT-129, GEN-146,
NEU-59, OBGYN-30, PED-18
80-6630..... CVT-116, GEN-115,
NEU-41, OBGYN-20, PED-45
80-6631..... CVT-83, GEN-115,
NEU-41, OBGYN-25, PED-14
80-6640..... CVT-198, NEU-115
80-6641..... CVT-198, NEU-115
80-6642..... CVT-198, NEU-115
80-6716..... ENT-131
80-8006..... CVT-226
81-1000..... GEN-21, NEU-14
81-1001..... GEN-21, NEU-12
81-1002..... GEN-21, NEU-11
81-1003..... LAP-32
81-1004..... LAP-32
81-1005..... LAP-32
81-1006..... GEN-21, NEU-11,
NEU-15
81-1010..... ENT-86, GEN-310,
NEU-126
81-1011..... ENT-86, GEN-310,
NEU-126
81-1012..... ENT-86, GEN-310,
NEU-126
83-6505..... GEN-19
83-6506..... GEN-19
84-1350..... GEN-303
84-8059..... CVT-201
84-8062..... CVT-201
84-8160..... CVT-201
84-9067..... CVT-116
85-1355..... CVT-198
85-2001..... GEN-298
85-2002..... GEN-298
85-2010..... GEN-286, OPH-63
85-2013..... GEN-286, OPH-63
85-2015..... GEN-286, OPH-63
85-2016..... GEN-260
85-2017..... GEN-260
85-2042..... GEN-267
85-2043..... GEN-267
85-2044..... GEN-267
85-2046..... GEN-267
85-2049..... GEN-270
85-2057..... GEN-275
85-2060..... GEN-275
85-2062..... GEN-275
85-2063..... ENT-137
85-2064..... ENT-137
85-2067..... GEN-275
85-2070..... GEN-275
85-2071..... GEN-275
85-2110..... CVT-209
85-2113..... CVT-209
85-2114..... CVT-209
85-2121..... ENT-136
85-2123..... ENT-136
85-2125..... ENT-136
85-2601..... GEN-298
85-3005..... GEN-272
85-6550..... OBGYN-4
86-1001..... CVT-209
86-1002..... CVT-209
86-1032..... CVT-212, CVT-213
86-1033..... CVT-212, CVT-213
86-1034..... CVT-212, CVT-213
86-2011..... GEN-286, OPH-59
86-2111..... GEN-286
86-2518..... GEN-254
86-3211..... GEN-275
86-3214..... GEN-275
86-3218..... GEN-275
86-3223..... GEN-275
86-3314..... GEN-275
86-3318..... GEN-275
86-3320..... GEN-275
86-3323..... GEN-275
86-3514..... GEN-275
86-3518..... GEN-275
86-4520..... GEN-254
86-5012..... GEN-298, OPH-59
86-5013..... GEN-298, OPH-59
86-5014..... GEN-267
86-5015..... ENT-137, GEN-262
86-5017..... GEN-267
86-5023..... GEN-267
86-5111..... GEN-298
86-5114..... GEN-267
86-5115..... ENT-137, GEN-262
86-5117..... GEN-267
86-5123..... GEN-267
86-5125..... GEN-298
86-5323..... GEN-266
86-6713..... ENT-137
86-6716..... ENT-137
87-0628..... CVT-55
88-1005..... SPN-84
88-1006..... SPN-84
88-2500..... O/A-61, SPN-85
88-2520..... O/A-58, SPN-85
88-4000..... GEN-124, NEU-56
89-1189..... LAP-11
89-1203..... LAP-12
89-1204..... LAP-12
90-0000..... LAP-26
90-0010..... LAP-75
90-0020..... LAP-75
90-0030..... ENG-44, LAP-75
90-1000..... ENG-23
90-1005..... LAP-8, LAP-46
90-1005B..... LAP-77
90-1005S..... LAP-77

90-1008.....LAP-52	LAP-49	90-3000 ENG-25, ENT-38
90-1011 LAP-91	90-1067B..... ENG-46, LAP-79	90-3035.....LAP-29
90-1012 LAP-91	90-1067BLENG-46, LAP-80,	90-3038..... LAP-31
90-1013 LAP-91	LAP-86	90-3038LLAP-31, OBE-39
90-1014 LAP-91	90-1067I..... ENG-46, LAP-79	90-3039..... LAP-31
90-1015 LAP-20, LAP-46	90-1067ILENG-46, LAP-80	90-4005 ENG-33, LAP-92
90-1015L.....LAP-46	90-1067LLAP-13	90-4010 ENG-33, LAP-92
90-1015S..... LAP-77	90-1068LAP-50	90-4012 ENG-33, LAP-92
90-1016..... LAP-91	90-1068B..... LAP-81	90-4015 ENG-33, LAP-92
90-1017 LAP-91	90-1068I.....ENG-47, LAP-81	90-5030..... LAP-27
90-1018.....LAP-90	90-1069 LAP-11, LAP-51	90-5048.....LAP-30
90-1019.....LAP-90	90-1069B..... LAP-81	90-5049.....LAP-30
90-1020 LAP-31	90-1069R..... LAP-81	90-5050.....LAP-30
90-1021..... LAP-31	90-1069RL LAP-11	90-5050LLAP-30
90-1030 ENG-47, LAP-10,	90-1070 LAP-20, LAP-51	90-5051LAP-30
LAP-46	90-1070B.....LAP-82	90-5051LLAP-30, OBE-2
90-1030B.....ENG-44, LAP-77	90-1070LLAP-20	90-5052.....LAP-30
90-1030BL LAP-77	90-1070R..... LAP-82	90-5052L.....LAP-30, OBE-2
90-1030I.....ENG-45, LAP-77	90-1071..... LAP-8	90-5053.....LAP-30
90-1030ILENG-45, LAP-77	90-1071B LAP-81	90-5053L LAP-30, OBE-42
90-1030L..... LAP-10	90-1071L LAP-8	90-5054..... LAP-31
90-1031.....LAP-50	90-1071R LAP-81	90-5055..... LAP-31
90-1033 ENG-47, LAP-6	90-1072..... LAP-6, LAP-52	90-5058..... LAP-31
90-1033E..... LAP-6	90-1072L LAP-6	90-5059..... LAP-31
90-1035 ENG-48, LAP-15,	90-1073..... ENG-49, LAP-48	90-5070.....LAP-26
LAP-47	90-1075..... ENG-49, LAP-16,	90-5099.....LAP-29
90-1035B.....LAP-78	LAP-45	90-5605..... LAP-27
90-1035I.....LAP-78	90-1075BLAP-76	90-6002..... OBE-37, RET-72
90-1035LLAP-15	90-1075L LAP-16, LAP-45	90-6003LAP-25, OBE-37,
90-1040ENG-48, LAP-16,	90-1075R LAP-76	RET-72
LAP-47	90-1076.....LAP-46	90-6004 LAP-25, OBE-37,
90-1040BLAP-78	90-1077.....LAP-45	RET-72
90-1040I ENG-45, LAP-78	90-1079LAP-45	90-6005..... LAP-25, RET-72
90-1040IL ENG-45	90-1079B..... LAP-75	90-6006LAP-25, OBE-37,
90-1040L..... LAP-16	90-1079BL LAP-76	RET-72
90-1042B..... ENG-45, LAP-79	90-1079R..... LAP-75	90-6007.....LAP-25, OBE-37,
90-1042BL ENG-45, LAP-78	90-1079RL..... LAP-76	RET-72
90-1042I..... ENG-45	90-1082LAP-50	90-6008 OBE-37, RET-72
90-1042IL ENG-45, LAP-78	90-1083LAP-48	90-7000..... ENG-14, ENT-37
90-1042R..... LAP-79	90-1089B..... LAP-76	90-7001 ENG-14, ENT-37
90-1044ENG-48, LAP-10,	90-1089R..... LAP-76	90-7004..... ENG-14, ENT-37
LAP-49	90-1115..... ENG-47, LAP-75	90-7005..... ENG-14, ENT-37
90-1044L LAP-10	90-1115L ENG-47, LAP-75	90-7006..... ENG-14, ENT-37
90-1050 LAP-12, LAP-48	90-1116..... ENG-47, LAP-75	90-8000 ENG-14, ENT-37
90-1050B..... LAP-79	90-1116L ENG-47, LAP-75	90-8001 ENG-14, ENT-37
90-1050LLAP-12	90-1117..... ENG-47, LAP-75	90-8003..... ENG-14, ENT-37
90-1050R..... LAP-79	90-1117L LAP-75	90-8006 ENG-15, ENT-37
90-1051B LAP-77, LAP-82	90-2000ENG-21	90-8007..... ENG-16, ENT-37
90-1051RLAP-82	90-2001ENG-21	90-8008 ENG-15, ENT-37
90-1055 LAP-47	90-2006I.....LAP-82	90-8009 ENG-16, ENT-37
90-1065 ENG-48, LAP-49	90-2008B.....LAP-82	90-8012 ENG-14, ENT-37
90-1065B.....ENG-46, LAP-80	90-2010LAP-52	90-8013 ENG-14, ENT-37
90-1065I.....ENG-46, LAP-80	90-2011.....LAP-30	90-8015 ENG-15, ENT-37
90-1066B.....ENG-46, LAP-80	90-2020..... ENG-49, LAP-49	90-8016 ENG-15, ENT-37
90-1066I.....ENG-46, LAP-80	90-2020LLAP-49	90-8017 ENG-16, ENT-37
90-1067ENG-48, LAP-13,	90-2210 LAP-51	90-8018 ENG-16, ENT-37

95-1005LLAP-63	96-1035NLLAP-84	98-1109L..... LAP-11
95-1005L-45.....LAP-63	96-1042NLLAP-85	98-1111 LAP-4
95-1015L.....LAP-63	96-1051R.....LAP-84	98-1112..... LAP-4
95-1015L-45.....LAP-63	96-1053R.....LAP-90	98-1113..... LAP-4
95-1031SLLAP-8, LAP-63	96-1056R.....LAP-87	98-1114..... LAP-4
95-1032LLAP-64	96-1056R-45.....LAP-88	98-1114L..... LAP-4
95-1045LLAP-65	96-1066NLLAP-87	98-1115..... LAP-5
95-1048LAP-66	96-1067-L.....LAP-13	98-1116..... LAP-5
95-1048SL-45LAP-14	96-1067NLLAP-86	98-1117..... LAP-5
95-1048SL-DA ..LAP-5, LAP-66	96-1068NLLAP-86	98-1118..... LAP-5
95-1048SL-DA-ROT.....LAP-66	96-1069R.....LAP-88	98-1119..... LAP-5
95-1048SL-ROTLAP-66	96-1070R.....LAP-88	98-1120 LAP-5
95-1048SL-ROT-45LAP-66	96-1072RLAP-89	98-1121L LAP-5
95-1049SL..... LAP-14, LAP-67	96-1079RLAP-83	98-1122 LAP-5
95-1049SL-45 . LAP-14, LAP-67	96-1089R.....LAP-83	98-1123 LAP-5
95-1049SL-DALAP-67	96-1092NLLAP-85	98-1124 LAP-5
95-1049SL-DA-45..... LAP-11,	96-2020NL.....LAP-86	98-1125 LAP-5
LAP-67	96-5600..... LAP-27	98-1125L..... LAP-5
95-1049SL-DA-ROT..... LAP-11,	97-1008RC LAP-74	98-1126 LAP-5
LAP-67	97-1030RC.....ENG-43, LAP-10,	98-1127 LAP-5
95-1049SL-ROT LAP-14, LAP-67	LAP-68	98-1127L..... LAP-5
95-1049SL-ROT-45 LAP-14,	97-1030RCLLAP-68	98-1128 LAP-5
LAP-67	97-1031RC LAP-8, LAP-70	98-1128L..... LAP-5
95-1050SL-DA-ROT.....LAP-12	97-1031RCL..... LAP-8	98-1129 LAP-6
95-1050SL-DA-ROT-45 .LAP-12	97-1035RC..... ENG-43, LAP-15,	98-1130 LAP-6
95-1051L.....LAP-67	LAP-69	98-1130L..... LAP-6
95-1052LLAP-62	97-1040RCLAP-70	98-1131..... LAP-6
95-1052L-45LAP-62	97-1042RC.....ENG-43, LAP-10	98-1132 LAP-6
95-1053LLAP-67	97-1048SL.....LAP-14	98-1133 LAP-6
95-1053L-45.....LAP-67	97-1050RC.....LAP-12	98-1134 LAP-6
95-1053SL-45..... ENG-38	97-1051DA-RC LAP-74	98-1135 LAP-6
95-1056LLAP-66	97-1051RCLAP-14, LAP-74	98-1136 LAP-6
95-1067.....LAP-65	97-1055RC..... LAP-15, LAP-69	98-1137 LAP-6
95-1067SL-ROT-45LAP-13	97-1056RC..... LAP-14, LAP-73	98-1138 LAP-6
95-1070..... LAP-60, LAP-66	97-1063RC..... LAP-72	98-1139 LAP-6
95-1078LLAP-62	97-1066RC..... LAP-72	98-1140LAP-7
95-1079LLAP-62	97-1067RC..... ENG-43, LAP-13,	98-1141.....LAP-7
95-1089LLAP-62	LAP-71	98-1142LAP-7
95-1089L-45.....LAP-62	97-1067RCL ... ENG-43, LAP-71	98-1143LAP-7
95-1092LLAP-63	97-1068RC..... LAP-72	98-1144LAP-7
95-1092L-45.....LAP-63	97-1068RCL LAP-72	98-1145LAP-7
95-1093LLAP-64	97-1069RC..... LAP-73	98-1146LAP-7
95-2006.....LAP-65	97-1077RC.....LAP-68	98-1146L.....LAP-7
95-2006-45LAP-65	97-1078RC..... LAP-18, LAP-74	98-1147LAP-7
95-2020-45.....LAP-64	97-1079RC.....LAP-68	98-1148LAP-7
96-0002NLLAP-84	97-1080RC LAP-73	98-1149LAP-7
96-0003R.....LAP-84	97-1083RC..... LAP-21, LAP-70	98-1150LAP-7
96-0004R.....LAP-84	97-1083RCL LAP-70	98-1150L.....LAP-7
96-0126LAP-87	97-1089RC.....LAP-9, LAP-68	98-1151.....LAP-7
96-0526.....LAP-87	97-1090RCLAP-71	98-1152LAP-7
96-0526-45LAP-87	97-1090RCLLAP-71	98-1153LAP-8
96-1008R.....LAP-89	97-1093RC.....LAP-69	98-1154LAP-8
96-1009R.....LAP-89	97-2006RC... ENG-44, LAP-72	98-1154L..... LAP-8
96-1022NLLAP-85	97-2006RCL .. ENG-44, LAP-72	98-1155LAP-8
96-1023RLAP-83	97-2020RC..... ENG-44, LAP-71	98-1156LAP-8
96-1030NLLAP-83	98-1048SL-DA-ROT..... LAP-5	98-1157LAP-8

98-1157L	LAP-8	98-1208	LAP-13	98-1254	LAP-18
98-1158	LAP-8	98-1209	LAP-13	98-1255	LAP-18
98-1159	LAP-9	98-1210	LAP-13	98-1256	LAP-18
98-1160	LAP-9	98-1211	LAP-13	98-1257	LAP-18
98-1161	LAP-9	98-1212	LAP-13	98-1258	LAP-18
98-1162	LAP-9	98-1213	LAP-14	98-1258L	LAP-18
98-1163L	LAP-9	98-1214	LAP-14	98-1259	LAP-19
98-1164	LAP-9	98-1215	LAP-14	98-1260	LAP-19
98-1164L	LAP-9	98-1216	LAP-14	98-1260L	LAP-19
98-1165	LAP-9	98-1217	LAP-14	98-1261	LAP-19
98-1165L	LAP-9	98-1217L	LAP-14	98-1261L	LAP-19
98-1166	LAP-9	98-1218L	LAP-14	98-1262	LAP-19
98-1167L	LAP-9	98-1220	LAP-14	98-1262L	LAP-19
98-1168	LAP-9	98-1221	LAP-15	98-1263	LAP-19
98-1169	LAP-9	98-1222L	LAP-15	98-1264	LAP-19
98-1170	LAP-9	98-1223L	LAP-15	98-1265	LAP-19
98-1170L	LAP-9	98-1224	LAP-15	98-1266	LAP-20
98-1171	LAP-9	98-1225	LAP-15	98-1267	LAP-20
98-1172	LAP-9	98-1225L	LAP-15	98-1268L	LAP-20
98-1172L	LAP-9	98-1226	LAP-15	98-1269	LAP-20
98-1173	LAP-9	98-1227	LAP-15	98-1270	LAP-20
98-1174	LAP-9	98-1228	LAP-15	98-1270L	LAP-20
98-1175	LAP-9	98-1229	LAP-15	98-1271	LAP-20
98-1176	LAP-10	98-1230	LAP-15	98-1272	LAP-20
98-1177	LAP-10	98-1231	LAP-15	98-1273	LAP-20
98-1178	LAP-10	98-1232	LAP-16	98-1273L	LAP-20
98-1179	LAP-10	98-1232L	LAP-16	98-1274	LAP-20
98-1180	LAP-10	98-1233	LAP-16	98-1275	LAP-20
98-1181	LAP-10	98-1234	LAP-16	98-1276	LAP-20
98-1182	LAP-10	98-1235	LAP-16	98-1277	LAP-20
98-1183	LAP-10	98-1236	LAP-16	98-1277L	LAP-20
98-1184	LAP-11	98-1236L	LAP-16	98-1278	LAP-21
98-1185	LAP-11	98-1237	LAP-16	98-1279	LAP-21
98-1186	LAP-11	98-1238	LAP-16	98-1280L	LAP-21
98-1186L	LAP-11	98-1238L	LAP-16	98-1281	LAP-21
98-1187	LAP-11	98-1239	LAP-16	98-1282	LAP-21
98-1188	LAP-11	98-1240	LAP-17	98-1283	LAP-21
98-1188L	LAP-11	98-1240L	LAP-17	98-1284	LAP-21
98-1191	LAP-11	98-1241	LAP-17	98-1284L	LAP-21
98-1192	LAP-11	98-1241L	LAP-17	98-1285	LAP-21
98-1193	LAP-11	98-1242	LAP-17	98-1286L	LAP-13
98-1194	LAP-11	98-1243	LAP-17	98-1288L	LAP-21
98-1195	LAP-11	98-1244	LAP-17	98-1911L	LAP-11
98-1196	LAP-12	98-1244L	LAP-17	99-00000	LAP-3
98-1197	LAP-12	98-1245	LAP-17	99-00000L	LAP-3
98-1198	LAP-12	98-1245L	LAP-17	99-11302	LAP-3
98-1198L	LAP-12	98-1246	LAP-17	99-11302L	LAP-3
98-1199	LAP-12	98-1247	LAP-17	99-11323	LAP-3
98-1199L	LAP-12	98-1248	LAP-17	99-11323L	LAP-3
98-1200	LAP-12, LAP-13	98-1249	LAP-17	99-11333	LAP-3
98-1201	LAP-12	98-1250	LAP-18	99-11333L	LAP-3
98-1202	LAP-12	98-1251	LAP-18	99-11345	LAP-3
98-1204L	LAP-12	98-1252	LAP-18	99-11345L	LAP-3
98-1205	LAP-12	98-1252L	LAP-18	99-11346	LAP-3
98-1206	LAP-13	98-1253	LAP-18	99-11346L	LAP-3
98-1207	LAP-13	98-1253L	LAP-18	99-11364	LAP-3

99-11364L	LAP-3	5022-04D	SS-25	9030-13	SS-3
99-11369	LAP-3	5022-04SD	SS-25	9040-01	SS-2
99-11369L	LAP-3	5022-50-000P	SS-22	9040-02	SS-2
99-21302	LAP-2	5022-50-175P	SS-23	9040-04	SS-3
99-21302L	LAP-2	5023-03-180P	SS-22	9040-08	SS-3
99-21323	LAP-2	5023-03-E	SS-23	9040-13	SS-3
99-21323L	LAP-2	5023-04	SS-25	9050-01	SS-2
99-21333	LAP-2	5023-04D	SS-25	9050-02	SS-2
99-21333L	LAP-2	5023-04-E	SS-25	9050-04	SS-3
99-21345	LAP-2	5023-04-E-D	SS-25	9050-08	SS-3
99-21345L	LAP-2	5023-04SD	SS-25	9050-13	SS-3
99-21346	LAP-2	5023-50-000P	SS-22	9090-90	SS-3
99-21346L	LAP-2	5023-50-175P	SS-23	9090-92	SS-3
99-21364	LAP-2	5023-50-E	SS-23	9090-93	SS-3
99-21364L	LAP-2	5024-03-180P	SS-22	9312-00	LAP-33, SS-33
99-21369	LAP-2	5108-04D	SS-25	9317-00	LAP-33, SS-33
99-21369L	LAP-2	5109-04D	SS-25	9321-00	LAP-33, SS-33
455-18300-SSI	O/A-29	5110-04	SS-25	9326-00	LAP-33, SS-33
455-19300-SSI	O/A-29	5110-04D	SS-25	9331-00	LAP-33, SS-33
455-20300-SSI	O/A-29	5110-04SD	SS-25	9417-1	LAP-32, SS-33
455-29200-SSI	O/A-29	5122-03-375P	SS-22	ABB-1A	CVT-15
502-002	RET-59	5123-03-375P	SS-22	ABB-1AB	CVT-15
1013-1-002	SS-15	5710-03-180P	SS-35	ABB-1V	CVT-16
1013-1-003	SS-15	5710-03-375P	SS-35	ABB-1VB	CVT-16
1013-1-004	SS-15	5710-50-000P	SS-35	ABB-2A	CVT-15
1013-1-005	SS-15	5722-03-180P	SS-35	ABB-2AB	CVT-15
1013-1-006	SS-15	5722-03-375P	SS-35	ABB-2V	CVT-16
2001-SP	SS-15	5722-50-000P	SS-35	ABB-2VB	CVT-16
5000-01-275P	SS-21	5723-03-180P	SS-35	ABB-3A	CVT-15
5000-01-375P	SS-21	5723-03-375P	SS-35	ABB-3AB	CVT-15
5000-01-475P	O/A-11, SS-18, SS-21	5723-50-000P	SS-35	ABB-3V	CVT-16
5000-04	SS-25	7024-01	SS-24	ABB-3VB	CVT-16
5000-04D	SS-25	7024-02	SS-24	ABB-11A	CVT-14
5000-04SD	SS-25	7024-04	SS-24	ABB-11AB	CVT-14
5000-50-000P	SS-21	7026-01	SS-24	ABB-11V	CVT-16
5000-50-175P	O/A-11, SS-18, SS-21	7026-02	SS-24	ABB-11VB	CVT-16
5006-01-390P	SS-23	7026-04SD	SS-25	ABB-22A	CVT-14
5006-03-150P	SS-23	7310-03-200S	ENT-8	ABB-22AB	CVT-14
5006-04	SS-25	7322-03-200S	ENT-8	ABB-22V	CVT-16
5006-04D	SS-25	8600-00	SS-36	ABB-22VB	CVT-16
5006-50-000P	SS-23	8600-01	SS-36	ABB-33A	CVT-14
5010-03-180P	SS-22	8600-02	SS-36	ABB-33AB	CVT-14
5010-04	SS-25	8600-03	SS-36	ABB-33V	CVT-16
5010-04D	SS-25	9000-09	O/A-50	ABB-33VB	CVT-16
5010-04SD	SS-25	9000-14	SS-3	ARTH-RACK	O/A-13, SS-13
5010-50-000P	SS-22	9020-01	SS-2	B-1A	CVT-14
5010-50-175P	SS-23	9020-02	SS-2	B-1AB	CVT-14
5012-03-180P	SS-22	9020-04	SS-3	B-1V	CVT-15
5012-04	SS-25	9020-08	SS-3	B-1VB	CVT-15
5012-04D	SS-25	9020-11	SS-3	B-2A	CVT-14
5012-04SD	SS-25	9020-12	SS-3	B-2AB	CVT-14
5012-50-000P	SS-22	9020-13	SS-3	B-2V	CVT-15
5022-03-180P	SS-22	9030-01	SS-2	B-2VB	CVT-15
5022-04	SS-25	9030-02	SS-2	B-3A	CVT-14
		9030-04	SS-3	B-3AB	CVT-14
		9030-08	SS-3	B-3V	CVT-15

B-3VB.....	CVT-15	BW0338014	CVT-146-148,	C18134-SP	SS-12
BB-1A	CVT-14	CVT-151, GEN-193-195, GEN-198,	OBE-56, OBE-60-62, RET-17-	C18135.....	SS-10
BB-1AB.....	CVT-14	20, RET-24		C18135-SP	SS-12
BB-1V	CVT-15	BW0338015		C18136	SS-10
BB-2A.....	CVT-14	CVT-146-148, CVT-151, OBE-57,		C18136-G.....	SS-11
BB-2AB.....	CVT-14	GEN-193-195, GEN-198, OBE-		C18136-SP	SS-12
BB-2V	CVT-15	60-62, OBGYN-38, RET-15,		C18138	SS-10
BB-3A.....	CVT-14	RET-17-20, RET-23		C22854	LAP-94, SS-10
BB-3AB.....	CVT-14	BW1043016.....	CVT-142,	C22854-SP	LAP-94, SS-12
BB-3V	CVT-15	CVT-146-148, GEN-189, GEN-		C22855.....	LAP-94, SS-10
B-SHUTT	O/A-12, SS-13	193-195, OBE-55, OBE-60-62,		C22856.....	LAP-94, SS-10
B1212-DRILL.....	O/A-10, SS-13	RET-12, RET-18-20		C22856-SP	LAP-94, SS-12
B-1275R.....	SS-14	BW1043029	CVT-142,	C22858.....	LAP-94, SS-10
B2175-LAP.....	LAP-95, SS-14	CVT-146-148, GEN-189, GEN-		C24134	SS-10
B2175-RONGEUR ..	O/A-11, SS-14	193-195, OBE-55, OBE-60-62,		C24134-SP.....	SS-12
B2312-LAP.....	LAP-95, SS-14	RET-12, RET-18-20		C24135	SS-10
B12121	SS-11	BW1044005.....	RET-19, RET-27	C24136	SS-10
B12122.....	SS-11	BW1045000.....		C24136-G.....	SS-11
B12122-SS	SS-12	CVT-141, CVT-146-148, GEN-187,		C24138	LAP-94, SS-10
B12123.....	SS-11	GEN-193-195, OBE-54, OBE-		C24138-G.....	SS-11
B12123-SS	SS-12	60-62, RET-10, RET-17-20		C24138-SP.....	SS-12
B12124.....	SS-11	BW1045069	CVT-146-148,	C181310	SS-10
B12124-SS	SS-12	GEN-189, GEN-193-195, OBE-55,		C181310-G	SS-11
B12751.....	SS-11	OBE-60-62, RET-12, RET-18-20		CSH-10.....	SS-45
B12752	SS-11	BW1045176		CSH-50	SS-45
B12752-SS	SS-12	CVT-141, CVT-146-148, GEN-187,		CSH-100	SS-45
B12753	SS-11	GEN-193-195, OBE-54, OBE-		DC-1.....	CVT-15
B12753-SS.....	SS-12	60-62, RET-10, RET-17-20		DC-2	CVT-15
B12754	SS-11	BW1045BKIT..	CVT-147, GEN-194,	DC-3	CVT-15
B12754-SS.....	SS-12	OBE-62, RET-20		DC15.....	SS-16
B17121	SS-11	BW1045BRT ...	CVT-148, OBE-61,	DC25	SS-16
B17122.....	SS-11	RET-19		DL15	SS-16
B17122-SS	SS-12	BW1046BKIT	CVT-146, GEN-193,	DL25	SS-16
B17123.....	SS-11	OBE-60, RET-18		DS15.....	SS-16
B17123-SS	SS-12	BW1046BRT .	CVT-148, GEN-195,	DS25	SS-16
B17124-SS	SS-12	OBE-61, RET-19		DX-2	REC-3
B21751.....	SS-11	BW1271017.....		DX-8	REC-3
B21752	SS-11	CVT-141, CVT-146-148, GEN-186,		DX-8-8	REC-3
B21753	SS-11	GEN-193-195, OBE-53, OBE-		DX-18.....	REC-3
B21754	SS-11	60-62, RET-9, RET-17-20		FL-5.....	SS-14
B21754-SS.....	SS-12	C13134	SS-10	FL5-100.....	SS-14
B23121.....	SS-11	C13134-SP	SS-12	FL-11.....	SS-14
B23122	SS-11	C13135.....	SS-10	FL11-100	SS-14
B23122-SS	SS-12	C13135-SP	SS-12	HD-D.....	CVT-16
B23123	SS-11	C13136.....	SS-10	HD-DB	CVT-16
B23123-SS.....	SS-12	C13136-G	SS-11	HD-S	CVT-16
B23124	SS-11	C13136-SP	SS-12	HD-SB	CVT-16
B23124-SS.....	SS-12	C13854.....	SS-10	KB1	SS-16
BW0144003		C13854-SP	SS-12	KB2.....	SS-16
CVT-147-148, CVT-155, GEN-194,		C13855.....	SS-10	KB3.....	SS-16
GEN-203, OBE-61-62, OBE-64,		C13855-SP.....	SS-12	KB4.....	SS-16
RET-19-20, RET-27		C13856.....	SS-10	KB5.....	SS-16
BW0144005 ..	CVT-146, CVT-148,	C13856.....	SS-10	KB6.....	SS-16
CVT-155, GEN-193, GEN-195,		C13856-G.....	SS-11	KB7.....	SS-16
GEN-203, OBE-60-61, OBE-64,		C13856-SP.....	SS-12	KB8.....	SS-16
RET-18		C18134	SS-10	KB9.....	SS-16

KB10.....	SS-16	4A8W091003.....	SS-29
KB11.....	SS-16	4A8W091303.....	SS-29
KB13.....	SS-16	4A8W092003.....	SS-29
KB15.....	SS-16	4A9W101003.....	SS-29
KB16.....	SS-16	4A9W102003.....	SS-29
P10.....	SS-16	4A9W102603.....	SS-29
P15.....	SS-16	4S5231.....	SS-27
P25.....	SS-16	4S0W101030.....	SS-30
P35.....	SS-16	4S0W101045.....	SS-30
PPR.....	SS-45	4S0W101060.....	SS-30
PPR-N.....	SS-45	4S0W102030.....	SS-30
PPR-W.....	SS-45	4S0W102045.....	SS-30
RD-D.....	CVT-16	4S0W102060.....	SS-30
RD-DB.....	CVT-16	4S0W102630.....	SS-30
RD-S.....	CVT-16	4S0W102645.....	SS-30
RD-SB.....	CVT-16	4S0W102660.....	SS-30
RP-OVAL.....	SS-14	4S1W091017.....	SS-30
RP-ROUND.....	SS-14	4S1W091317.....	SS-30
SB5.....	SS-16	4S1W092017.....	SS-30
SB7.....	SS-16	4S2W091011.....	SS-30
SB10.....	SS-16	4S2W091018.....	SS-30
SM11570.....	SS-15	4S2W091026.....	SS-30
SM115115.....	SS-15	4S2W092011.....	SS-30
SM165115.....	SS-15	4S2W092018.....	SS-30
SM225115.....	SS-15	4S2W092026.....	SS-30
SPO1115-45.....	LAP-23	4S2W092511.....	SS-30
ST-6.....	GEN-311, SS-45	4S2W092518.....	SS-30
ST-8.....	GEN-311, SS-45	4S2W092526.....	SS-30
ST-10.....	GEN-311, SS-45	4S8W091003.....	SS-30
ST-12.....	GEN-311, SS-45	4S8W091303.....	SS-30
ST-14.....	GEN-311, SS-45	4S8W092003.....	SS-30
ST-16.....	GEN-311, SS-45	4S9W101003.....	SS-30
ST-18.....	GEN-311, SS-45	4S9W102003.....	SS-30
ST-20.....	GEN-311, SS-45	4S9W102603.....	SS-30
4A231404.....	SS-29		
4A0W101030.....	SS-29		
4A0W101045.....	SS-29		
4A0W101060.....	SS-29		
4A0W102030.....	SS-29		
4A0W102045.....	SS-29		
4A0W102060.....	SS-29		
4A0W102630.....	SS-29		
4A0W102645.....	SS-29		
4A0W102660.....	SS-29		
4A1W091017.....	SS-29		
4A1W091317.....	SS-29		
4A1W092017.....	SS-29		
4A2W091011.....	SS-29		
4A2W091018.....	SS-29		
4A2W091026.....	SS-29		
4A2W092011.....	SS-29		
4A2W092018.....	SS-29		
4A2W092026.....	SS-29		
4A2W092511.....	SS-29		
4A2W092518.....	SS-29		
4A2W092526.....	SS-29		